

Small Signal Zener Diodes

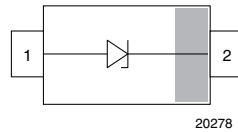

 AUTOMOTIVE
GRADE
Available

RoHS
COMPLIANT

FEATURES

- Silicon planar Zener diodes
- Standard Zener voltage tolerance is $\pm 5\%$
- AEC-Q101 qualified available
- ESD capability according to AEC-Q101:
Human body model > 8 kV
Machine model > 800 V
- Base P/N-E3 - RoHS-compliant, commercial grade
- Base P/N-HE3_A - RoHS-compliant, AEC-Q101 qualified
- Material categorization: for definitions of compliance please see www.vishay.com/doc?99912

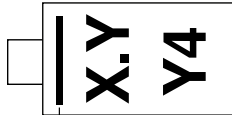
MARKING (example only)

 X.Y = type code
Y4 = date code

23210 Cathode mark

LINKS TO ADDITIONAL RESOURCES



PRIMARY CHARACTERISTICS		
PARAMETER	VALUE	UNIT
V_Z range nom.	2.4 to 43	V
Test current I_{ZT}	0.05	mA
V_Z specification	Thermal equilibrium	
Circuit configuration	Single	

ORDERING INFORMATION				
DEVICE NAME	ORDERING CODE	AEC-Q101 QUALIFIED	TAPED UNITS PER REEL	MINIMUM ORDER QUANTITY
MMSZ4681 to MMSZ4717	MMSZ4681-E3-08 to MMSZ4717-E3-08	no	3000 (8 mm tape on 7" reel)	15 000/box
	MMSZ4681-HE3_A-08 to MMSZ4717-HE3_A-08	yes		
	MMSZ4681-E3-18 to MMSZ4717-E3-18	no	10 000 (8 mm tape on 13" reel)	10 000/box
	MMSZ4681-HE3_A-18 to MMSZ4717-HE3_A-18	yes		

PACKAGE				
PACKAGE NAME	WEIGHT	MOLDING COMPOUND FLAMMABILITY RATING	MOISTURE SENSITIVITY LEVEL	SOLDERING CONDITIONS
SOD-123	10.6 mg	UL 94 V-0	MSL level 1 (according J-STD-020)	Peak temperature max. 260 °C

ABSOLUTE MAXIMUM RATINGS ($T_{amb} = 25\text{ °C}$, unless otherwise specified)				
PARAMETER	TEST CONDITION	SYMBOL	VALUE	UNIT
Power dissipation	$R_{thJL} = 250\text{ K/W}$	P_{tot}	500	mW
	On FR-4 board with recommended soldering footprint	P_{tot}	300	mW
Thermal resistance junction to lead		R_{thJL}	250	K/W
Thermal resistance junction to ambient	According to JEDEC® 51-3 on FR-4 board with recommended soldering footprint	R_{thJA}	420	K/W
Junction temperature		T_j	150	°C
Storage temperature range		T_{stg}	-65 to +150	
Operating temperature range		T_{op}	-55 to +150	



ELECTRICAL CHARACTERISTICS ($T_{amb} = 25\text{ }^{\circ}\text{C}$, unless otherwise specified)							
PART NUMBER	MARKING CODE	ZENER VOLTAGE RANGE ⁽¹⁾			TEST CURRENT	REVERSE CURRENT	
		V_Z at I_{ZT1}			I_{ZT1}	I_R at V_R	
		V			mA	μA	V
		MIN.	NOM.	max.		MAX.	
MMSZ4681	TF	2.28	2.4	2.52	0.05	2	1
MMSZ4682	TH	2.57	2.7	2.84	0.05	1	1
MMSZ4683	TJ	2.85	3	3.15	0.05	0.8	1
MMSZ4684	TK	3.14	3.3	3.47	0.05	7.5	1.5
MMSZ4685	TM	3.42	3.6	3.78	0.05	7.5	2
MMSZ4686	TN	3.71	3.9	4.1	0.05	5	2
MMSZ4687	TP	4.09	4.3	4.52	0.05	4	2
MMSZ4688	TT	4.47	4.7	4.94	0.05	10	3
MMSZ4689	TU	4.85	5.1	5.36	0.05	10	3
MMSZ4690	TV	5.32	5.6	5.88	0.05	10	4
MMSZ4691	TA	5.89	6.2	6.51	0.05	10	5
MMSZ4692	TX	6.46	6.8	7.14	0.05	10	5.1
MMSZ4693	TY	7.13	7.5	7.88	0.05	10	5.7
MMSZ4694	TZ	7.79	8.2	8.61	0.05	1	6.2
MMSZ4695	UC	8.27	8.7	9.14	0.05	1	6.6
MMSZ4696	UD	8.65	9.1	9.56	0.05	1	6.9
MMSZ4697	UE	9.5	10	10.5	0.05	1	7.6
MMSZ4698	UF	10.5	11	11.6	0.05	0.05	8.4
MMSZ4699	UH	11.4	12	12.6	0.05	0.05	9.1
MMSZ4700	UJ	12.4	13	13.7	0.05	0.05	9.8
MMSZ4701	UK	13.3	14	14.7	0.05	0.05	10.6
MMSZ4702	UM	14.3	15	15.8	0.05	0.05	11.4
MMSZ4703	UN	15.2	16	16.8	0.05	0.05	12.1
MMSZ4704	UP	16.2	17	17.9	0.05	0.05	12.9
MMSZ4705	UT	17.1	18	18.9	0.05	0.05	13.6
MMSZ4706	UU	18.1	19	20	0.05	0.05	14.4
MMSZ4707	UV	19	20	21	0.05	0.01	15.2
MMSZ4708	UA	20.9	22	23.1	0.05	0.01	16.7
MMSZ4709	UZ	22.8	24	25.2	0.05	0.01	18.2
MMSZ4710	UY	23.8	25	26.3	0.05	0.01	19
MMSZ4711	ZA	25.7	27	28.4	0.05	0.01	20.4
MMSZ4712	ZC	26.6	28	29.4	0.05	0.01	21.2
MMSZ4713	ZD	28.5	30	31.5	0.05	0.01	22.8
MMSZ4714	ZE	31.4	33	34.7	0.05	0.01	25
MMSZ4715	ZF	34.2	36	37.8	0.05	0.01	27.3
MMSZ4716	ZH	37.1	39	41	0.05	0.01	29.6
MMSZ4717	ZJ	40.9	43	45.2	0.05	0.01	32.6

Notes

- Maximum $V_F = 0.9\text{ V}$ at $I_F = 10\text{ mA}$
- (1) Measured with device junction in thermal equilibrium typ. R_{thJA} of 370 K/W



TYPICAL CHARACTERISTICS (T_{amb} = 25 °C, unless otherwise specified)

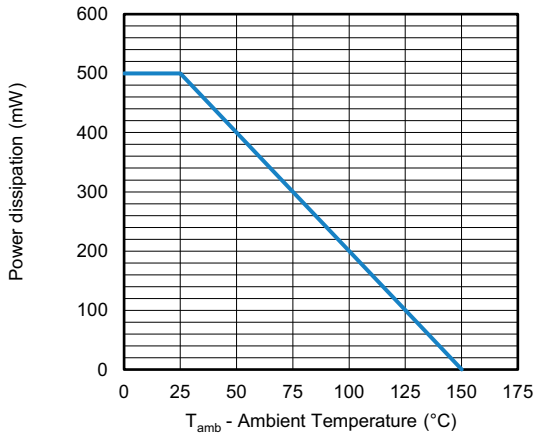

Fig. 1 - Admissible Power Dissipation vs. Ambient Temperature

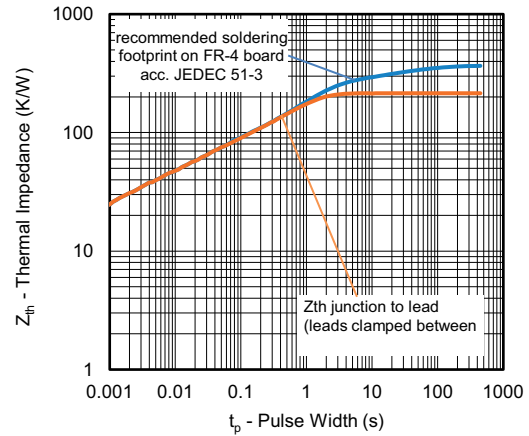
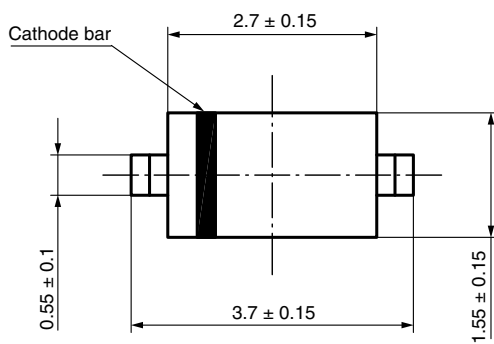
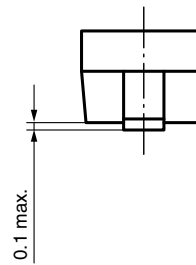
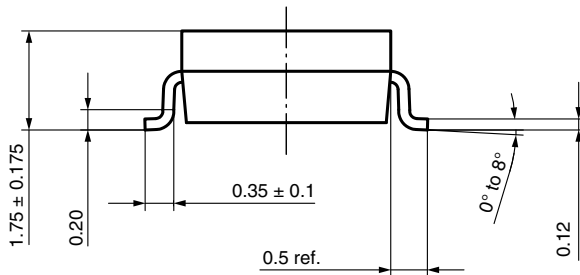
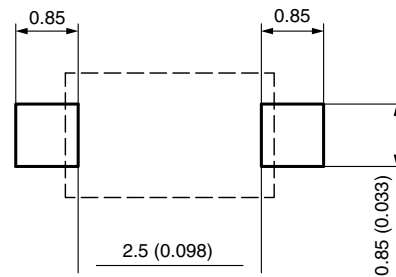

Fig. 2 - Thermal Impedance vs. Time

PACKAGE DIMENSIONS in millimeters (inches): SOD-123



Mounting Pad Layout





ORIENTATION IN CARRIER TAPE

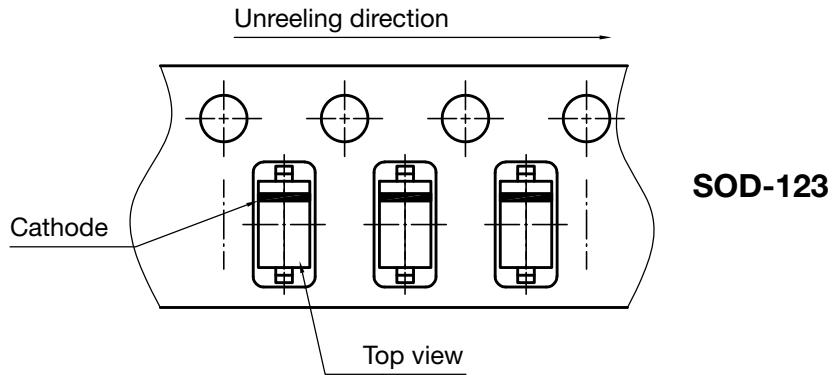

Created - Date: 09. Feb. 2016
Rev. 01 - Date: 07. Nov. 2022
Document no.: S8-V-3717.10-003 (4)

CARRIER TAPE

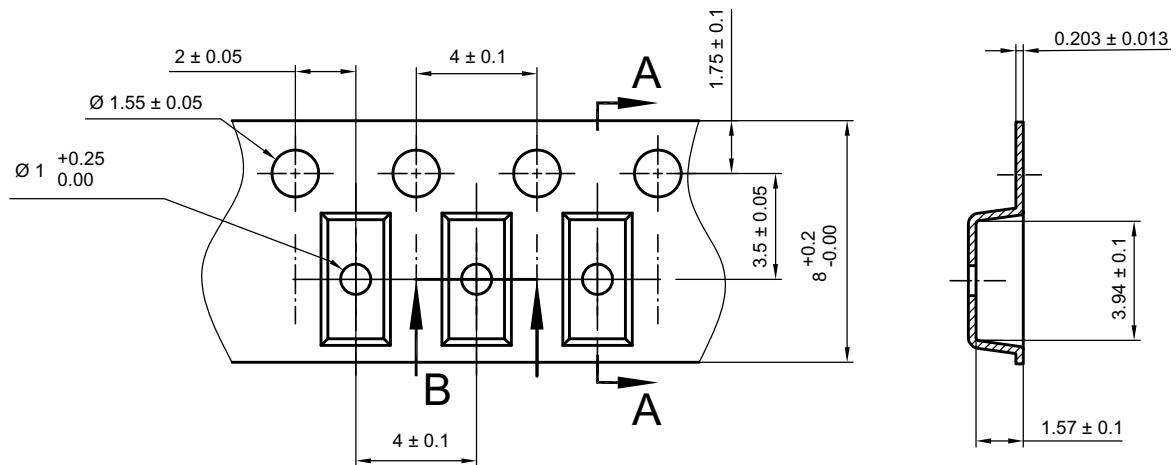

B-B Section

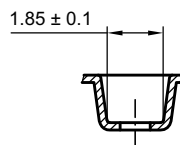

Created - Date: 07. Feb. 2013
Rev. 01 - Date: 01. Mar. 2014
Document no.: S8-V-3717.10-003 (4)



Disclaimer

ALL PRODUCT, PRODUCT SPECIFICATIONS AND DATA ARE SUBJECT TO CHANGE WITHOUT NOTICE TO IMPROVE RELIABILITY, FUNCTION OR DESIGN OR OTHERWISE.

Vishay Intertechnology, Inc., its affiliates, agents, and employees, and all persons acting on its or their behalf (collectively, "Vishay"), disclaim any and all liability for any errors, inaccuracies or incompleteness contained in any datasheet or in any other disclosure relating to any product.

Vishay makes no warranty, representation or guarantee regarding the suitability of the products for any particular purpose or the continuing production of any product. To the maximum extent permitted by applicable law, Vishay disclaims (i) any and all liability arising out of the application or use of any product, (ii) any and all liability, including without limitation special, consequential or incidental damages, and (iii) any and all implied warranties, including warranties of fitness for particular purpose, non-infringement and merchantability.

Statements regarding the suitability of products for certain types of applications are based on Vishay's knowledge of typical requirements that are often placed on Vishay products in generic applications. Such statements are not binding statements about the suitability of products for a particular application. It is the customer's responsibility to validate that a particular product with the properties described in the product specification is suitable for use in a particular application. Parameters provided in datasheets and / or specifications may vary in different applications and performance may vary over time. All operating parameters, including typical parameters, must be validated for each customer application by the customer's technical experts. Product specifications do not expand or otherwise modify Vishay's terms and conditions of purchase, including but not limited to the warranty expressed therein.

Hyperlinks included in this datasheet may direct users to third-party websites. These links are provided as a convenience and for informational purposes only. Inclusion of these hyperlinks does not constitute an endorsement or an approval by Vishay of any of the products, services or opinions of the corporation, organization or individual associated with the third-party website. Vishay disclaims any and all liability and bears no responsibility for the accuracy, legality or content of the third-party website or for that of subsequent links.

Except as expressly indicated in writing, Vishay products are not designed for use in medical, life-saving, or life-sustaining applications or for any other application in which the failure of the Vishay product could result in personal injury or death. Customers using or selling Vishay products not expressly indicated for use in such applications do so at their own risk. Please contact authorized Vishay personnel to obtain written terms and conditions regarding products designed for such applications.

No license, express or implied, by estoppel or otherwise, to any intellectual property rights is granted by this document or by any conduct of Vishay. Product names and markings noted herein may be trademarks of their respective owners.