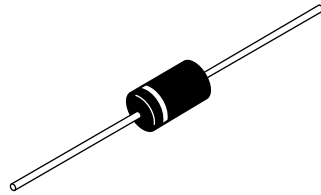

Schottky Rectifier, 3 A

C-16

FEATURES

- Low profile, axial leaded outline
- Very low forward voltage drop
- High frequency operation
- High purity, high temperature epoxy encapsulation for enhanced mechanical strength and moisture resistance
- Guard ring for enhanced ruggedness and long term reliability
- Lead (Pb)-free plating
- Designed and qualified for industrial level

RoHS
COMPLIANT

PRODUCT SUMMARY

$I_{F(AV)}$	3 A
V_R	50/60 V
V_F at 3 A at 25 °C	0.73 V
I_{RM}	15 mA at 125 °C

DESCRIPTION

The MBR350, MBR360 axial leaded Schottky rectifier has been optimized for very low forward voltage drop, with moderate leakage. Typical applications are in switching power supplies, converters, freewheeling diodes, and reverse battery protection.

MAJOR RATINGS AND CHARACTERISTICS

SYMBOL	CHARACTERISTICS	VALUES	UNITS
$I_{F(AV)}$	Rectangular waveform	3.0	A
V_{RRM}		50/60	V
I_{FSM}	$t_p = 5 \mu s$ sine	460	A
V_F	3 Apk, $T_J = 25 \text{ }^\circ\text{C}$	0.73	V
T_J		- 40 to 150	$^\circ\text{C}$

VOLTAGE RATINGS

PARAMETER	SYMBOL	MBR350	MBR360	UNITS
Maximum DC reverse voltage	V_R	50	60	V
Maximum working peak reverse voltage	V_{RWM}			

ABSOLUTE MAXIMUM RATINGS

PARAMETER	SYMBOL	TEST CONDITIONS	VALUES	UNITS
Maximum average forward current See fig. 4	$I_{F(AV)}$	50 % duty cycle at $T_L = 50 \text{ }^\circ\text{C}$, rectangular waveform	3.0	A
Maximum peak one cycle non-repetitive surge current See fig. 6	I_{FSM}	5 μs sine or 3 μs rect. pulse	460	
		10 ms sine or 6 ms rect. pulse	80	
Non-repetitive avalanche energy	E_{AS}	$T_J = 25 \text{ }^\circ\text{C}$, $I_{AS} = 1 \text{ A}$, $L = 10 \text{ mH}$	5.0	mJ
Repetitive avalanche current	I_{AR}	Current decaying linearly to zero in 1 μs Frequency limited by, T_J maximum $V_A = 1.5 \times V_R$ typical	1.0	A

ELECTRICAL SPECIFICATIONS					
PARAMETER	SYMBOL	TEST CONDITIONS		VALUES	UNITS
Maximum forward voltage drop See fig. 1	$V_{FM}^{(1)}$	1.0 A	$T_J = 25\text{ }^\circ\text{C}$	0.58	V
		3.0 A		0.73	
		9.4 A		1.06	
		1.0 A	$T_J = 125\text{ }^\circ\text{C}$	0.49	
		3.0 A		0.64	
		9.4 A		0.89	
Maximum reverse leakage current See fig. 2	$I_{RM}^{(1)}$	$T_J = 25\text{ }^\circ\text{C}$	$V_R = \text{Rated } V_R$	0.6	mA
		$T_J = 100\text{ }^\circ\text{C}$		8	
		$T_J = 125\text{ }^\circ\text{C}$		15	
Typical junction capacitance	C_T	$V_R = 5\text{ }V_{DC}$ (test signal range 100 kHz to 1 MHz) 25 °C		190	pF
Typical series inductance	L_S	Measured lead to lead 5 mm from package body		9.0	nH
Maximum voltage rate of change	dV/dt	Rated V_R		10 000	V/ μ s

Note

(1) Pulse width < 300 μ s, duty cycle < 2 %

THERMAL - MECHANICAL SPECIFICATIONS					
PARAMETER	SYMBOL	TEST CONDITIONS		VALUES	UNITS
Maximum junction and storage temperature range	$T_J^{(1)}, T_{Stg}$			- 40 to 150	$^\circ\text{C}$
Maximum thermal resistance, junction to lead	$R_{thJL}^{(2)}$	DC operation See fig. 4		30	$^\circ\text{C}/\text{W}$
Approximate weight				1.2	g
				0.042	oz.
Marking device		Case style C-16		MBR350	
				MBR360	

Notes

(1) $\frac{dP_{tot}}{dT_J} < \frac{1}{R_{thJA}}$ thermal runaway condition for a diode on its own heatsink

(2) Mounted 1" square PCB, thermal probe connected to lead 2 mm from package

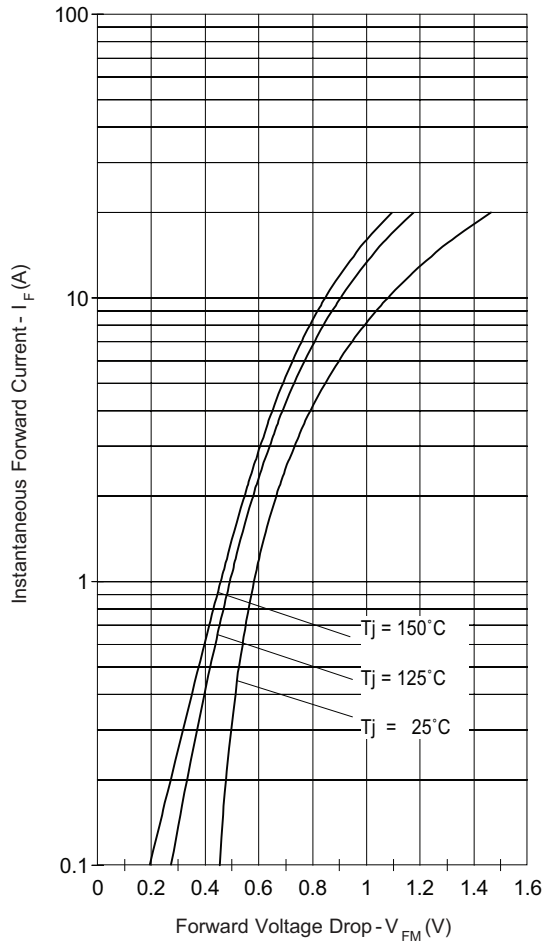

Fig. 1 - Maximum Forward Voltage Drop Characteristics

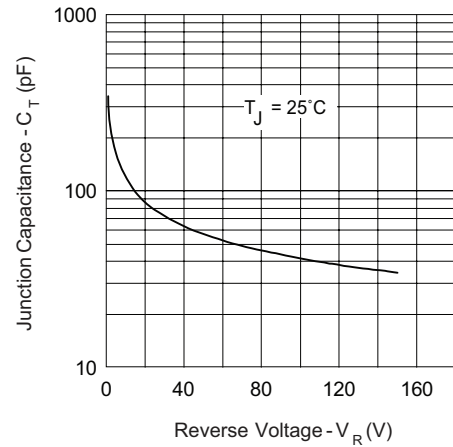

Fig. 3 - Typical Junction Capacitance vs. Reverse Voltage

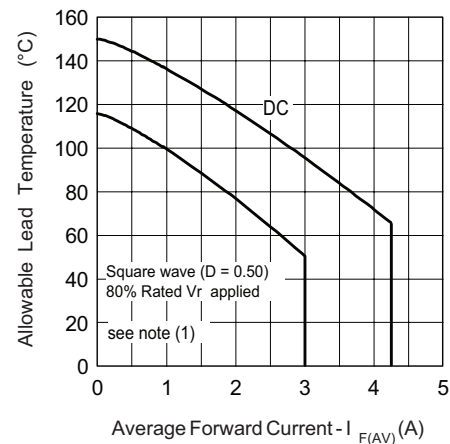

Fig. 4 - Maximum Allowable Lead Temperature vs. Average Forward Current

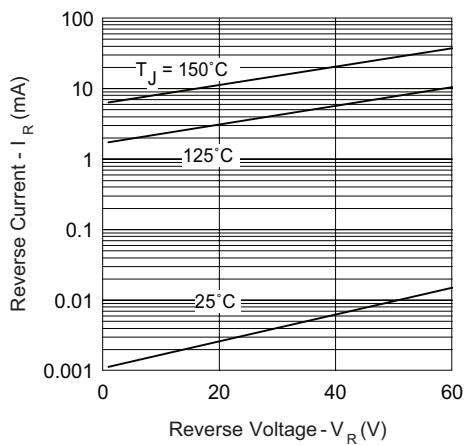

Fig. 2 - Typical Values of Reverse Current vs. Reverse Voltage

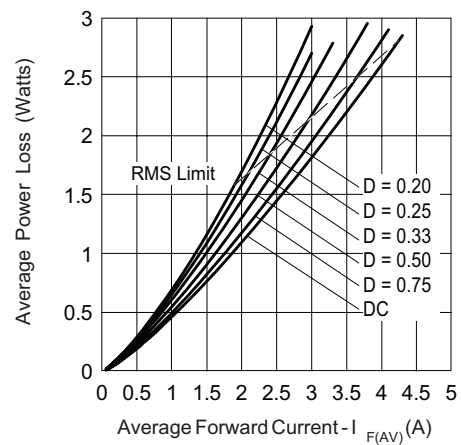

Fig. 5 - Forward Power Loss Characteristics

Note

(1) Formula used: $T_C = T_J - (Pd + Pd_{REV}) \times R_{thJC}$;

Pd = Forward power loss = $I_{F(AV)} \times V_{FM}$ at $(I_{F(AV)}/D)$ (see fig. 6); Pd_{REV} = Inverse power loss = $V_{R1} \times I_R (1 - D)$; I_R at $V_{R1} = 80\%$ rated V_R

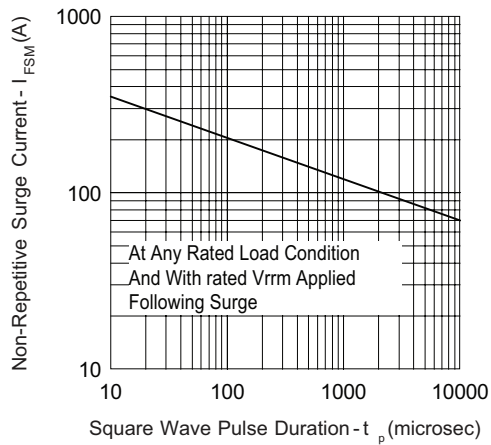

Fig. 6 - Maximum Non-Repetitive Surge Current

ORDERING INFORMATION TABLE

Device code	MBR	3	60	TR
	①	②	③	④
	<p>1 - Schottky MBR series</p> <p>2 - Current rating: 3 = 3 A</p> <p>3 - Voltage rating ——— 50 = 50 V 60 = 60 V</p> <p>4 - TR = Tape and reel package (1200 pcs) None = Box package (500 pcs)</p>			

LINKS TO RELATED DOCUMENTS	
Dimensions	http://www.vishay.com/doc?95242
Part marking information	http://www.vishay.com/doc?95304
Packaging information	http://www.vishay.com/doc?95309

Axial DO-201AD (C-16)

DIMENSIONS in millimeters (inches)

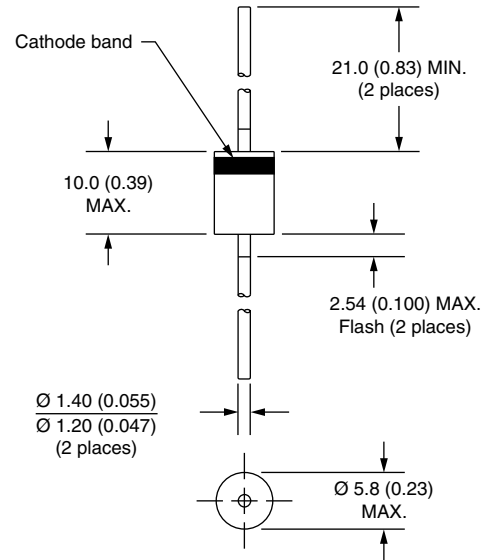
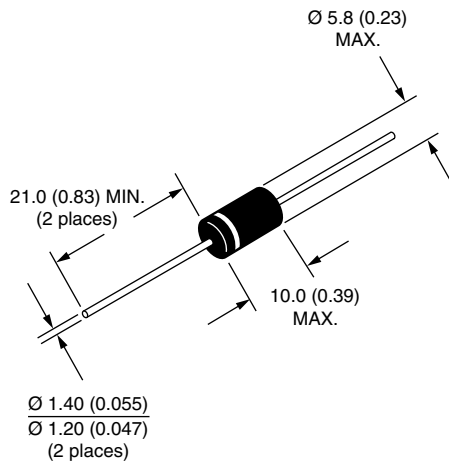



Disclaimer

ALL PRODUCT, PRODUCT SPECIFICATIONS AND DATA ARE SUBJECT TO CHANGE WITHOUT NOTICE TO IMPROVE RELIABILITY, FUNCTION OR DESIGN OR OTHERWISE.

Vishay Intertechnology, Inc., its affiliates, agents, and employees, and all persons acting on its or their behalf (collectively, "Vishay"), disclaim any and all liability for any errors, inaccuracies or incompleteness contained in any datasheet or in any other disclosure relating to any product.

Vishay makes no warranty, representation or guarantee regarding the suitability of the products for any particular purpose or the continuing production of any product. To the maximum extent permitted by applicable law, Vishay disclaims (i) any and all liability arising out of the application or use of any product, (ii) any and all liability, including without limitation special, consequential or incidental damages, and (iii) any and all implied warranties, including warranties of fitness for particular purpose, non-infringement and merchantability.

Statements regarding the suitability of products for certain types of applications are based on Vishay's knowledge of typical requirements that are often placed on Vishay products in generic applications. Such statements are not binding statements about the suitability of products for a particular application. It is the customer's responsibility to validate that a particular product with the properties described in the product specification is suitable for use in a particular application. Parameters provided in datasheets and/or specifications may vary in different applications and performance may vary over time. All operating parameters, including typical parameters, must be validated for each customer application by the customer's technical experts. Product specifications do not expand or otherwise modify Vishay's terms and conditions of purchase, including but not limited to the warranty expressed therein.

Except as expressly indicated in writing, Vishay products are not designed for use in medical, life-saving, or life-sustaining applications or for any other application in which the failure of the Vishay product could result in personal injury or death. Customers using or selling Vishay products not expressly indicated for use in such applications do so at their own risk and agree to fully indemnify and hold Vishay and its distributors harmless from and against any and all claims, liabilities, expenses and damages arising or resulting in connection with such use or sale, including attorneys fees, even if such claim alleges that Vishay or its distributor was negligent regarding the design or manufacture of the part. Please contact authorized Vishay personnel to obtain written terms and conditions regarding products designed for such applications.

No license, express or implied, by estoppel or otherwise, to any intellectual property rights is granted by this document or by any conduct of Vishay. Product names and markings noted herein may be trademarks of their respective owners.