

QUAD BUS BUFFERS (3-STATE)

- **HIGH SPEED**
 $t_{PD} = 10 \text{ ns (TYP.) at } V_{CC} = 5\text{V}$
- **LOW POWER DISSIPATION**
 $I_{CC} = 4 \mu\text{A (MAX.) at } T_A = 25^\circ\text{C}$
- **HIGH NOISE IMMUNITY**
 $V_{NIH} = V_{NIL} = 28\% V_{CC} \text{ (MIN.)}$
- **OUTPUT DRIVE CAPABILITY**
 15 LSTTL LOADS
- **SYMMETRICAL OUTPUT IMPEDANCE**
 $|I_{OH}| = |I_{OL}| = 6 \text{ mA (MIN.)}$
- **BALANCED PROPAGATION DELAYS**
 $t_{PLH} = t_{PHL}$
- **WIDE OPERATING VOLTAGE RANGE**
 $V_{CC} \text{ (OPR)} = 2\text{V to } 6\text{V}$
- **PIN AND FUNCTION COMPATIBLE**
 WITH 54/74LS125/126

DESCRIPTION

The M54/74HC125 and the M54/74HC126 are high speed CMOS QUAD BUS BUFFERS (3-STATE) fabricated in silicon gate C²MOS technology.

They have the same high speed performance of LSTTL combined with true CMOS low power consumption.

These devices require the 3-STATE control input G to be taken high to make the output go into the high impedance state.

All inputs are equipped with protection circuits against static discharge and transient excess voltage.

TRUTH TABLES

HC 125		
INPUTS	OUTPUT	
A	\bar{G}	Y
X	H	Z
L	L	L
H	L	H

HC126		
INPUTS	OUTPUT	
A	G	Y
X	L	Z
L	H	L
H	H	H

X: DON'T CARE Z: HIGH IMPEDANCE

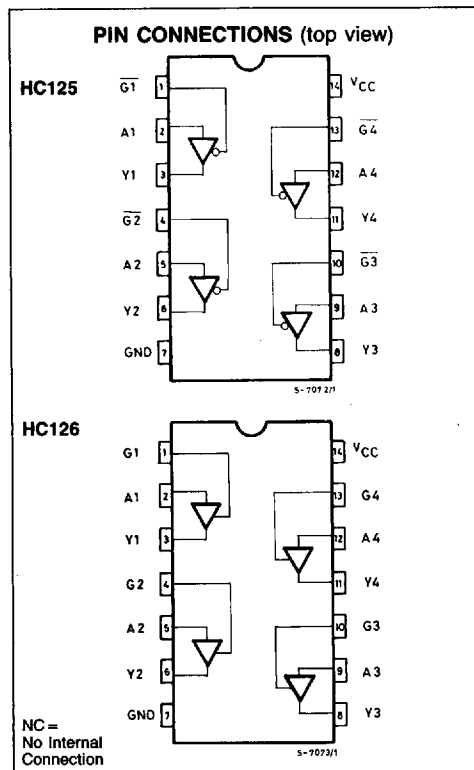
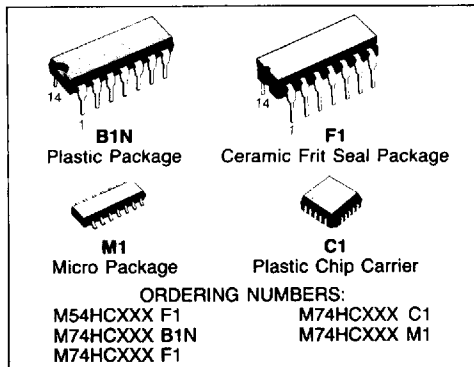

CHIP CARRIER

S G S-THOMSON

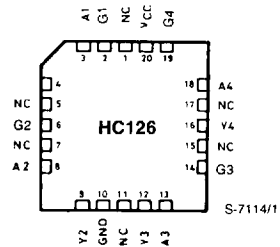
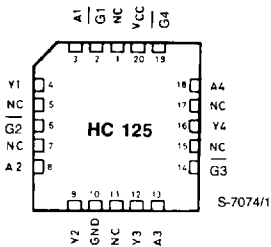

ABSOLUTE MAXIMUM RATINGS

Symbol	Parameter	Value	Unit
V_{CC}	Supply Voltage	-0.5 to 7	V
V_I	DC Input Voltage	-0.5 to $V_{CC} + 0.5$	V
V_O	DC Output Voltage	-0.5 to $V_{CC} + 0.5$	V
I_{IK}	DC Input Diode Current	± 20	mA
I_{OK}	DC Output Diode Current	± 20	mA
I_O	DC Output Source Sink Current Per Output Pin	± 35	mA
I_{CC} or I_{GND}	DC V_{CC} or Ground Current	± 70	mA
P_D	Power Dissipation	500 (*)	mW
T_{stg}	Storage Temperature	-65 to 150	$^{\circ}C$

Absolute Maximum Ratings are those values beyond which damage to the device may occur. Functional operation under these conditions is not implied.

(*) 500 mW: $\cong 65^{\circ}C$ derate to 300 mW by 10 mW/ $^{\circ}C$: $65^{\circ}C$ to $85^{\circ}C$.

RECOMMENDED OPERATING CONDITIONS

Symbol	Parameter	Value	Unit
V_{CC}	Supply Voltage	2 to 6	V
V_I	Input Voltage	0 to V_{CC}	V
V_O	Output Voltage	0 to V_{CC}	V
T_A	Operating Temperature	74HC Series 54HC Series	$^{\circ}C$
		-40 to 85 -55 to 125	
t_r, t_f	Input Rise and Fall Time	$V_{CC} \begin{cases} 2 \text{ V} & 0 \text{ to } 1000 \\ 4.5 \text{ V} & 0 \text{ to } 500 \\ 6 \text{ V} & 0 \text{ to } 400 \end{cases}$	ns

S G S-THOMSON

CIRCUIT DIAGRAM

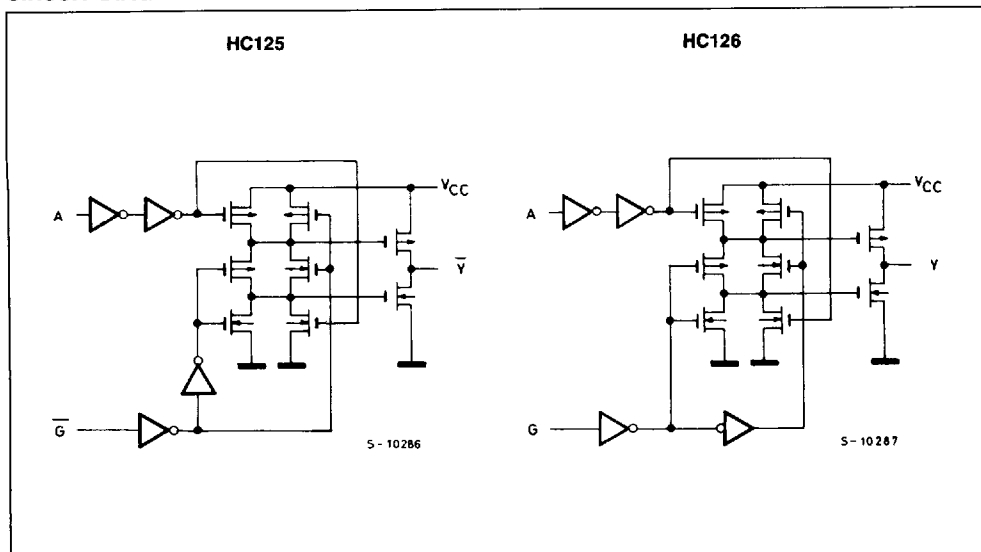

DC ELECTRICAL CHARACTERISTICS

Symbol	Parameter	V _{CC}	Test Condition	T _A = 25°C 54HC and 74HC			-40 to 85°C 74HC		-55 to 125°C 54HC		Unit	
				Min.	Typ.	Max.	Min.	Max.	Min.	Max.		
V _{IH}	High Level Input Voltage	2.0 4.5 6.0		1.5 3.15 4.2	— — —	— — —	1.5 3.15 4.2	— — —	1.5 3.15 4.2	— — —	V	
V _{IL}	Low Level Input Voltage	2.0 4.5 6.0		— — —	— — —	0.5 1.35 1.8	— — —	0.5 1.35 1.8	— — —	0.5 1.35 1.8	V	
V _{OH}	High Level Output Voltage	2.0	V _I	I _O	1.9	2.0	—	1.9	—	1.9	—	V
		4.5	V _{IH} or V _{IL}		4.4	4.5	—	4.4	—	4.4	—	
		6.0			5.9	6.0	—	5.9	—	5.9	—	
		4.5		-6.0 mA	4.18	4.31	—	4.13	—	4.10	—	
		6.0		-7.8 mA	5.68	5.8	—	5.63	—	5.60	—	
V _{OL}	Low Level Output Voltage	2.0	V _{IH} or V _{IL}	20 μA	—	0.0	0.1	—	0.1	—	0.1	V
		4.5			—	0.0	0.1	—	0.1	—	0.1	
		6.0			—	0.0	0.1	—	0.1	—	0.1	
		4.5		6.0 mA	—	0.17	0.26	—	0.33	—	0.40	
		6.0		7.8 mA	—	0.18	0.26	—	0.33	—	0.40	
I _I	Input Leakage Current	6.0	V _I = V _{CC} or GND	—	—	±0.1	—	±1.0	—	±1.0	μA	
I _{OZ}	3-State Output Off-State Current	6.0	V _I = V _{IH} or V _{IL} V _O = V _{CC} or GND	—	—	±0.5	—	±5.0	—	±10	μA	
I _{CC}	Quiescent Supply Current	6.0	V _I = V _{CC} or GND	—	—	4	—	40	—	80	μA	

AC ELECTRICAL CHARACTERISTICS ($C_L = 50\text{pF}$, Input $t_r = t_f = 6\text{ns}$)

Symbol	Parameter	V_{CC}	Test Condition	$T_A = 25^\circ\text{C}$ 54HC and 74HC			-40 to 85°C 74HC		-55 to 125°C 54HC		Unit
				Min.	Typ.	Max.	Min.	Max.	Min.	Max.	
t_{TLH} t_{THL}	Output Transition Time	2.0 4.5 6.0		— — —	25 7 6	60 12 10	— — —	75 15 13	— — —	90 18 15	ns
t_{PLH} t_{PHL}	Propagation Delay Time	2.0 4.5 6.0		— — —	52 13 11	100 20 17	— — —	125 25 21	— — —	150 30 26	ns
t_{PLH} t_{PHL}	3-State Output	2.0 4.5 6.0	$R_L = 1\text{K}\Omega$	— — —	44 11 19	90 18 15	— — —	115 23 20	— — —	135 27 23	ns
t_{PLZ} t_{PHZ}	3-State Output Disable Time	2.0 4.5 6.0	$R_L = 1\text{K}\Omega$	— — —	68 17 4	120 24 20	— — —	150 30 26	— — —	180 36 31	pF
C_{IN}	Input Capacitance			—	5	10	—	10			pF
$C_{PD} (*)$	Power Dissipation Capacitance			—	34	—	—	—			pF

Note (*) C_{PD} is defined as the value of the IC's internal equivalent capacitance which is calculated from the operating current consumption without load.

Average operating current can be obtained by the following equation.
 $I_{CC(oper)} = C_{PD} \cdot V_{CC} \cdot f_{IN} + I_{CC}/4$ (per Circuit)

SWITCHING CHARACTERISTICS TEST WAVEFORM

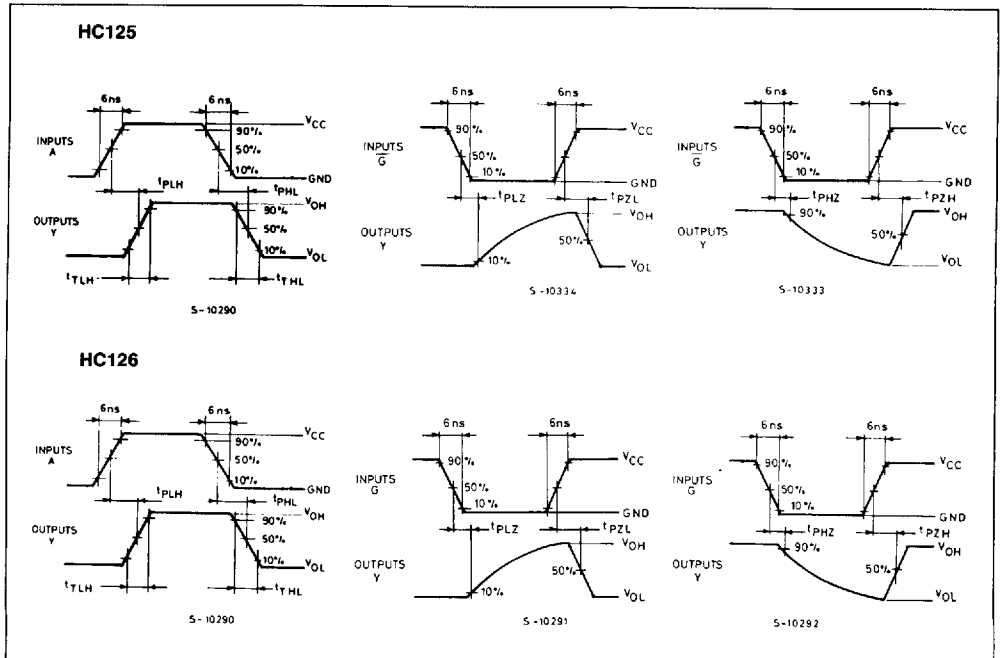

S G S-THOMSON

TEST CIRCUIT I_{CC} (Opr.)

HC125

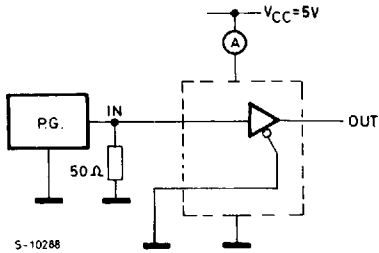

INPUT WAVEFORM

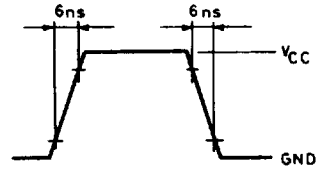
THE OTHER INPUTS ARE CONNECTED TO V_{CC} LINE OR GND LINE.

HC126

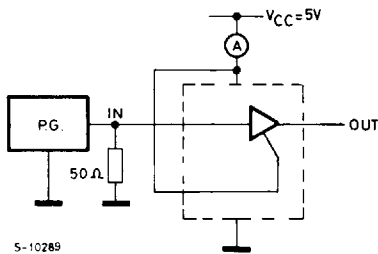

INPUT WAVEFORM

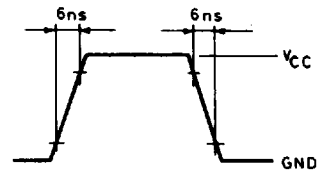
THE OTHER INPUTS ARE CONNECTED TO V_{CC} LINE OR GND LINE.