

*RoHS COMPLIANT

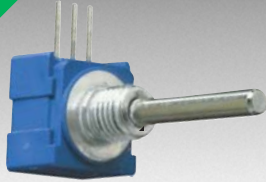

BOURNS®

Features

- RoHS compliant*
- Conductive plastic or cermet
- Linear and audio tapers
- PC board and bushing mount
- Gangable
- Metal bushing and shaft
- Sealed for board washing



51/53 - Sealed 1/2 " (12.5 mm) Square Control

Electrical Characteristics¹

	Conductive Plastic	Cermet
Standard Resistance Range		
Linear	1 K ohms to 1 megohm.....	150 ohms to 1 megohm
Audio.....	1 K ohms to 1 megohm.....	1 K ohms to 1 megohm
Total Resistance Tolerance		
Linear Tapers.....	±10 % or ±20 %.....	±10 % or ±5 %
Audio Tapers.....	±10 % or ±20 %.....	±10 %
Independent Linearity.....	±5 %.....	±5 %
Absolute Minimum Resistance.....	2 ohms maximum.....	2 ohms maximum
Effective Electrical Angle.....	270 ° ±5 °.....	270 ° ±5 °
Contact Resistance Variation.....	2 %.....	2 %
Dielectric Withstanding Voltage (MIL-STD-202 – Method 301)		
Sea Level.....	1,500 VAC minimum.....	1,500 VAC minimum
70,000.....	500 VAC minimum.....	500 VAC minimum
Insulation Resistance.....	1,000 megohms minimum.....	1,000 megohms minimum
Power Rating At 70 °C (Derate To 0 At 125 °C) (Voltage Limited By Power Dissipation or 350 VAC, Whichever Is Less)		
Linear Tapers.....	0.5 watt.....	1.0 watt
Audio Tapers.....	0.25 watt.....	0.5 watt
Theoretical Resolution.....	Essentially infinite.....	Essentially infinite

Environmental Characteristics¹

Operating Temperature Range	+1 °C to +125 °C.....	+1 °C to +125 °C
Storage Temperature Range	-55 °C to +125 °C.....	-55 °C to +125 °C
Temperature Coefficient Over Storage Temperature Range	±1,000 ppm/°C.....	±150 ppm/°C
Vibration (Single Section).....	15 G.....	15 G
Total Resistance Shift.....	±2 % maximum.....	±2 % maximum
Voltage Ratio Shift.....	±5 % maximum.....	±5 % maximum
Shock (Single Section).....	30 G.....	30 G
Total Resistance Shift.....	±2 % maximum.....	±2 % maximum
Voltage Ratio Shift.....	±5 % maximum.....	±5 % maximum
Load Life.....	1,000 hours.....	1,000 hours
Total Resistance Shift.....	±10 % TRS maximum.....	±5 % TRS maximum
Rotational Life (No Load).....	50,000 cycles.....	25,000 cycles
Total Resistance Shift.....	±10 % TRS maximum.....	±10 % TRS maximum
Contact Resistance Variation @ 25,000 Cycles.....	±2 %.....	±4 %
Moisture Resistance (MIL-STD-202, Method 103, Condition B)		
Total Resistance Shift.....	±10 % TRS.....	±5 % TRS
IP Rating.....	IP 64.....	IP 64

Mechanical Characteristics

Stop Strength	56 N-cm (5 lb.-in.)
Mechanical Angle.....	290 ° ±5 °
Torque	
Starting (Dual Sections).....	+0.35 N-cm (+0.5 oz.-in.) maximum
Running (Single Section).....	0.15 to 1.4 N-cm (0.2 to 2.0 oz.-in.)
Running (Dual Section).....	0.35 to 1.8 N-cm (0.5 to 2.5 oz.-in.)
Mounting (Torque on Bushing).....	1.7 to 2.0 N-m (15 to 18 lb.-in.) maximum
Weight (Single Section).....	5.5 grams
(Additional Section).....	3.0 grams
Terminals.....	PC pin or solder lug
Soldering Condition	Recommended hand soldering using Sn95/Ag5 no clean solder, 0.025 " wire diameter. Maximum temperature 399 °C (750 °F) for 3 seconds. No wash process to be used with no clean flux. Part can be wave soldered at 260 °C (500 °F) for 5 seconds, no wash process with no clean flux.
Marking.....	Manufacturer's trademark, part number, resistance value and date code.
Ganging (Multiple Section Potentiometer)	2 sections maximum**
Hardware.....	One lockwasher and one mounting nut is shipped with each potentiometer, except where noted in the part number.

¹At room ambient: +25 °C nominal and 50 % relative humidity nominal, except as noted.

** Additional sections available on special request with higher minimum order quantities.

*RoHS Directive 2002/95/EC Jan 27, 2003 including Annex. Specifications are subject to change without notice.

Customers should verify actual device performance in their specific applications.

51/53 - Sealed 1/2" (12.5 mm) Square Control

BOURNS®

Product Dimensions

PACKAGE DIMENSIONS

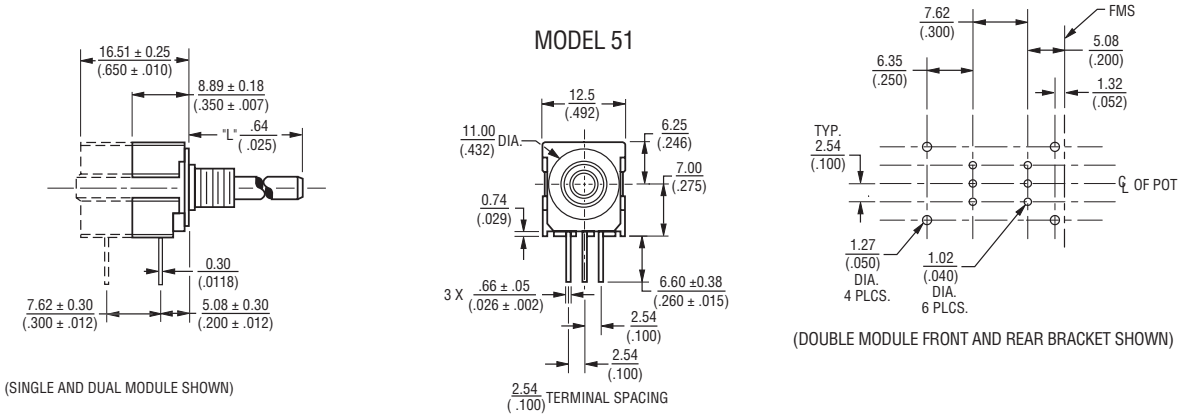

PACKAGE DIMENSIONS PCB MOUNTING BRACKET

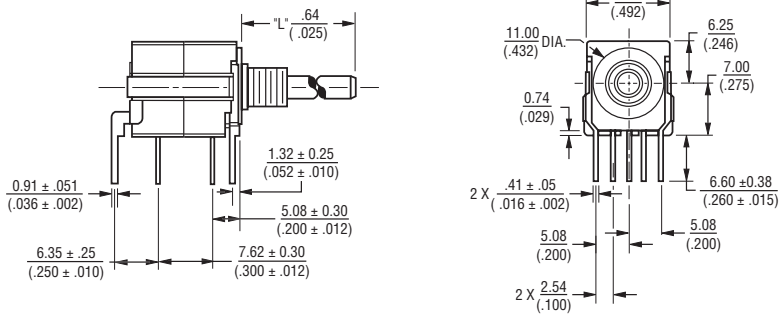

SOLDER LUG TERMINALS MODEL 53

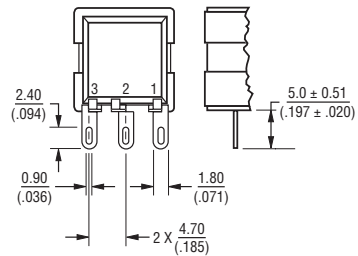

ELECTRICAL SCHEMATIC

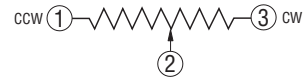

ANTI-ROTATION LUG (Style "A", 90° CW Shown)

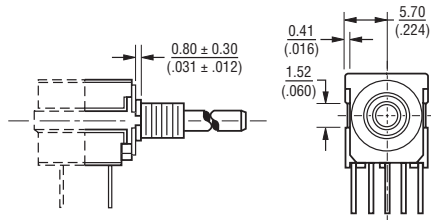

DIMENSIONS: $\frac{\text{MM}}{\text{(INCHES)}}$

SHAFT FLAT ORIENTATION

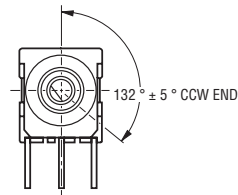

SUGGESTED PANEL LAYOUTS

The Model 50 can be used with either of the two panel layouts shown below.

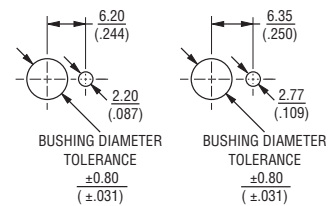

FOR TOLERANCES SHOWN: XX ± $\frac{.25}{.010}$
 XXX ± $\frac{.13}{.005}$
 SHAFT DIMENSIONS ± $\frac{.80}{.1/32}$

Specifications are subject to change without notice. Customers should verify actual device performance in their specific applications.

51/53 - Sealed 1/2" (12.5 mm) Square Control

BOURNS®

Shaft/Bushing Styles

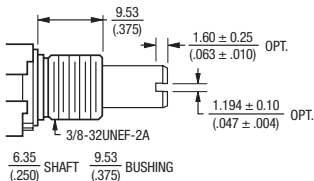

A Style Bushing

STD. LENGTH "L"
.500 (12.7)
.625 (15.88)
.750 (19.05)
.875 (22.23)
1.000 (25.4)

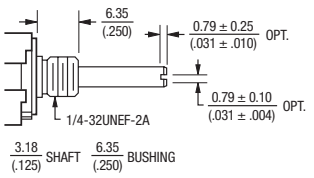

C Style Bushing

STD. LENGTH "L"
.375 (9.53)
.500 (12.7)
.625 (15.88)
.750 (19.05)
.875 (22.23)
1.000 (25.4)

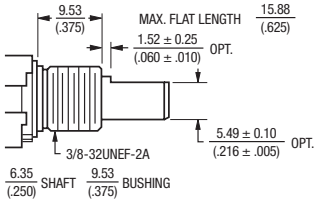

A Style Bushing - Flatted Shaft

STD. LENGTH "L"
.625 (15.88)
.750 (19.05)
.875 (22.23)
1.000 (25.4)

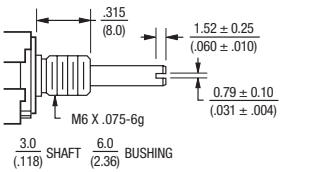

S Style Bushing

STD. LENGTH "L"
.394 (10.0)
.512 (13.0)
.630 (16.0)
.866 (22.0)
.984 (25.0)

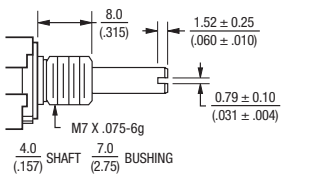

U Style Bushing

STD. LENGTH "L"
.394 (10.0)
.512 (13.0)
.630 (16.0)
.866 (22.0)
.984 (25.0)

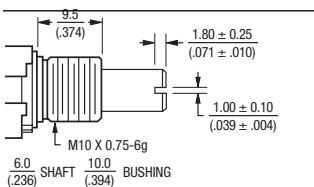

R Style Bushing

STD. LENGTH "L"
.512 (13.0)
.630 (16.0)
.866 (22.0)
.984 (25.0)

DIMENSIONS: $\frac{\text{MM}}{\text{(INCHES)}}$

How To Order

51 A A D - B 28 - A 15 L

MOUNTING BRACKET/ ANTI-ROTATION LUG	
Code	Description
A	AR Lug 90 °CW
D	No AR Lug or Bracket
L	Front Bracket
M	Rear Bracket
N	Front and Rear Bracket

# SECTIONS/DETENTS	
Code	Description
A	Single No Detent
B	Double No Detent
E	Single w/Center Detent
F	Double w/Center Detent

BUSHING CONFIGURATION	
Code	Description
A	3/8" D x 3/8" L
C	1/4" D x 1/4" L
R	10 mm D x 9.5 mm L
S	6 mm D x 8 mm L
U	7 mm D x 8 mm L

MODEL	
Code	Description
51	PC Pins (.100" centers)
53	Solder Lugs

RoHS IDENTIFIER	
Code	Description
L	Compliant

ELEMENT TAPER TYPE/TOLERANCE		RESISTANCE (CODE)	
Code	Description	VALUE IN OHMS	
(A)	Linear Cermet ±10 %	(28) — 150	(14) — 7.5 K
(H)	Linear Cermet ±5 %	(06) — 200	(15) — 10 K
		(07) — 250	(30) — 15 K
		(08) — 500	(16) — 20 K
		(09) — 750	(17) — 25 K
		(10) — 1 K	(18) — 50 K
		(29) — 1.5 K	(19) — 75 K
		(11) — 2 K	(20) — 100 K
		(12) — 2.5 K	(23) — 500 K
		(13) — 5 K	(25) — 1 M
(B)	Linear C-P ±20 %	(10) — 1 K	(18) — 50 K
(E)	Linear C-P ±10 %	(12) — 2.5 K	(20) — 100 K
		(13) — 5 K	(22) — 250 K
		(15) — 10 K	(23) — 500 K
		(16) — 20 K	(25) — 1 M
		(17) — 25 K	
(C)	CW Audio Cermet ±10 %	(10) — 1 K	(18) — 50 K
(F)	CCW Audio Cermet ±10 %	(12) — 2.5 K	(20) — 100 K
		(13) — 5 K	(23) — 500 K
		(15) — 10 K	(25) — 1 M
		(17) — 25 K	
(D)	CW Audio C-P ±20 %	(10) — 1 K	(18) — 50 K
(S)	CW Audio C-P ±10 %	(12) — 2.5 K	(20) — 100 K
		(13) — 5 K	(22) — 250 K
		(15) — 10 K	(23) — 500 K
		(17) — 25 K	(25) — 1 M
(G)	CCW Audio C-P ±20 %	(10) — 1 K	(18) — 50 K
(T)	CCW Audio C-P ±10 %	(12) — 2.5 K	(20) — 100 K
		(13) — 5 K	(22) — 250 K
		(15) — 10 K	(23) — 500 K
		(17) — 25 K	(25) — 1 M
(Y)	CW Dual Audio Taper C-P ±20 %	(10) — 1 K	(18) — 50 K
		(12) — 2.5 K	(20) — 100 K
		(13) — 5 K	(22) — 250 K
		(15) — 10 K	(23) — 500 K
		(17) — 25 K	(25) — 1 M

SHAFT TYPE		AVAILABLE ONLY IN BUSHINGS	
Code	Description	Code	Description
B	Single Slotted 1/4 "D	A	24,28
C	Single Flatted 1/4 "D	A	20,24,28,32
D	Single Plain 1/8 "D	C	16,20,24,28
E	Single Slotted 1/8 "D	C	12,16,20,24,28
R	Single Slotted 6 mmD	R	16,22,25
T	Single Slotted 4 mmD	U	16,22,25
U	Single Slotted 3 mmD	S	16,22,25

SHAFT LENGTH (FMS)		AVAILABLE ONLY IN BUSHING
Code	Description	Code
12	3/8 "	C
16	1/2 "	A, C
20	5/8 "	A, C
24	3/4 "	A, C
28	7/8 "	A, C
32	1 "	A, C
Metric		
16	16 mm	R, S, U
22	22 mm	R, S, U
25	25 mm	R, S, U

Boldface features are Bourns standard options. All others are available with higher minimum order quantities.