

VGA Connector

SPECIFICATIONS

Mechanical

Contact Engagement Force: 0.34kg (0.75Lb) max.
Contact Separation Force: 0.021kg (0.05Lb) min.
Durability: 500 Cycles

Electrical

Current Rating: 2A
Contact Resistance: 25mW max.
Dielectric Withstanding Voltage: 1000V AC/1min min.
Insulation Resistance: 5000MW min.

Physical

Housing: Thermoplastic, UL 94V-0 rated in Blue 661C Color
Contact: Copper alloy
Plating: See "ORDERING INFORMATION"
Operating Temperature: -20 to +85
Recommended Thickness of PCB: 1.57[.062]

DZ Series
Right Angle Type, T/H
2.29mm [.090"] Pitch
15 Pos.

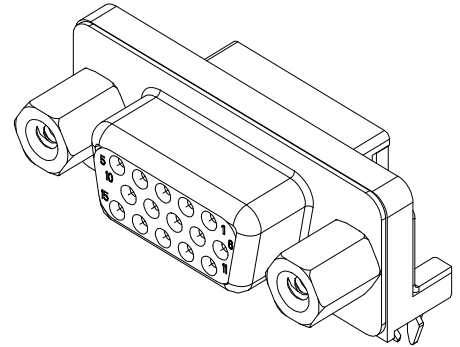

DRAWING

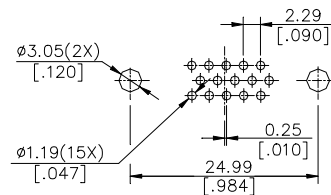
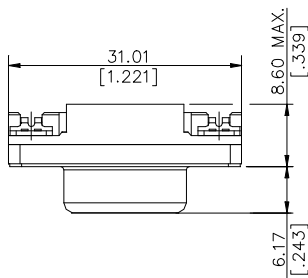

RECOMMENDED P.C.B. LAYOUT

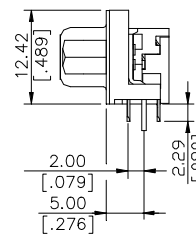
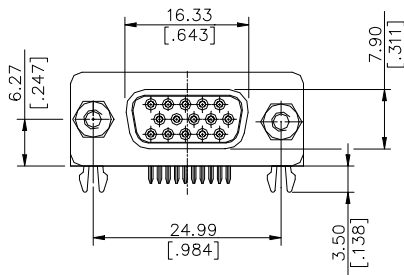

ORDERING INFORMATION

PRODUCT NO.: DZ 1 1 A A * - H2N1 - 4F

