

1 Megabit 3.3V Static RAM 256K x 4-Bit Revolutionary Pinout

Features

- High-speed access times
 - Com'l: 10, 12, 15 and 20 ns
 - Ind'l: 12, 15 and 20 ns
- Low power operation (typical)
 - PDM31038SA
 - Active: 200 mW
 - Standby: 25 mW
- Single +3.3V ($\pm 0.3V$) power supply
- TTL-compatible inputs and outputs
- Packages
 - Plastic SOJ (300 mil) - TSO
 - Plastic SOJ (400 mil) - SO
 - Plastic TSOP - T

Description

The PDM31038 is a high-performance CMOS static RAM organized as 262,144 x 4 bits. Writing to this device is accomplished when the write enable (\overline{WE}) and the chip enable (\overline{CE}) inputs are both LOW. Reading is accomplished when \overline{WE} remains HIGH and \overline{CE} and \overline{OE} are both LOW.

The PDM31038 operates from a single +3.3V power supply and all the inputs and outputs are fully TTL-compatible.

The PDM31038 is available in a 32-pin 300-mil and 400-mil plastic SOJ, and a 32-pin plastic TSOP for surface mount applications in revolutionary pinout.

Functional Block Diagram

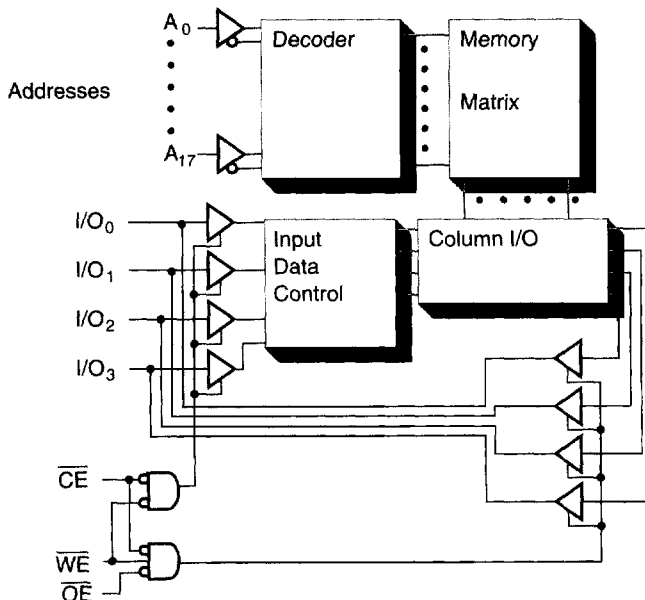

Pin Configuration

Pin Description

Name	Description
A17-A0	Address Inputs
I/O3-I/O0	Data Inputs/Outputs
\overline{OE}	Output Enable Input
\overline{WE}	Write Enable Input
\overline{CE}	Chip Enable Input
NC	No Connect
V _{CC}	Power (+3.3V)
V _{SS}	Ground

TSOP

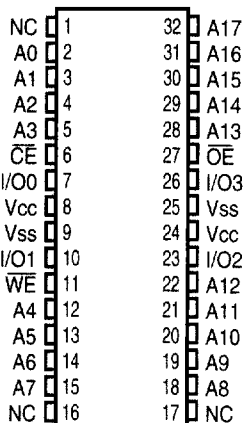

SOJ

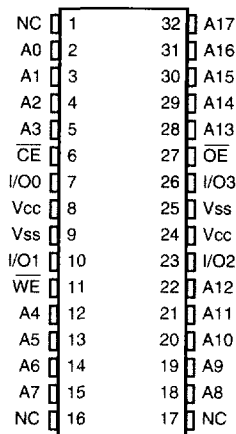

Truth Table⁽¹⁾

\overline{OE}	\overline{WE}	\overline{CE}	I/O	MODE
X	X	H	Hi-Z	Standby
L	H	L	D _{OUT}	Read
X	L	L	D _{IN}	Write
H	H	L	Hi-Z	Output Disable

NOTE: 1. H = V_{IH}, L = V_{IL}, X = DON'T CARE

Absolute Maximum Ratings⁽¹⁾

Symbol	Rating	Com'l.	Ind.	Unit
V _{TERM}	Terminal Voltage with Respect to V _{SS}	-0.5 to +4.6	-0.5 to +4.6	V
T _{BIAS}	Temperature Under Bias	-55 to +125	-65 to +135	°C
T _{STG}	Storage Temperature	-55 to +125	-65 to +150	°C
P _T	Power Dissipation	1.0	1.0	W
I _{OUT}	DC Output Current	50	50	mA
T _J	Maximum Junction Temperature ⁽²⁾	125	125	°C

- NOTE: 1. Stresses greater than those listed under ABSOLUTE MAXIMUM RATINGS may cause permanent damage to the device. This is a stress rating only and functional operation of the device at these or any other conditions above those indicated in the operational sections of this specification is not implied. Exposure to absolute maximum rating conditions for extended periods may affect reliability.
2. Appropriate thermal calculations should be performed in all cases and specifically for those where the chosen package has a large thermal resistance (e.g., TSOP). The calculation should be of the form: $T_j = T_a + P * \theta_{ja}$ where T_a is the ambient temperature, P is average operating power and θ_{ja} the thermal resistance of the package. For this product, use the following θ_{ja} values:

SOJ: 72° C/W
 TSOP: 95° C/W

Recommended DC Operating Conditions

Symbol	Parameter	Min.	Typ.	Max.	Unit
V _{CC}	Supply Voltage	3.0	3.3	3.6	V
V _{SS}	Supply Voltage	0	0	0	V
Industrial	Ambient Temperature	-40	25	85	°C
Commercial	Ambient Temperature	0	25	70	°C

DC Electrical Characteristics (V_{CC} = 3.3V, ± 0.3V)

Symbol	Parameter	Test Conditions		Min.	Max.	Unit
I _{LI}	Input Leakage Current	V _{CC} = MAX., V _{IN} = V _{SS} to V _{CC}	Com'l/ Ind.	-5	5	µA
I _{LO}	Output Leakage Current	V _{CC} = MAX., CE = V _{IH} , V _{OUT} = V _{SS} to V _{CC}	Com'l/ Ind.	-5	5	µA
V _{IL}	Input Low Voltage			-0.3 ⁽¹⁾	0.8	V
V _{IH}	Input High Voltage			2.2	V _{CC} +0.3	V
V _{OL}	Output Low Voltage	I _{OL} = 8 mA, V _{CC} = Min. I _{OL} = 10 mA, V _{CC} = Min.		—	0.4 0.5	V V
V _{OH}	Output High Voltage	I _{OH} = -4 mA, V _{CC} = Min.		2.4	—	V

NOTE: 1. V_{IL}(min) = -3.0V for pulse width less than 20 ns

Power Supply Characteristics

Symbol	Parameter	-10		-12		-15		-20		Unit
		Com'l.	Ind.	Com'l.	Ind.	Com'l.	Ind.	Com'l.	Ind.	
I _{CC}	Operating Current CE = V _{IL} f = f _{MAX} = 1/t _{RC} V _{CC} = Max. I _{OUT} = 0 mA	85	80	85	70	75	50	55	mA	
I _{SB}	Standby Current CE = V _{IH} f = f _{MAX} = 1/t _{RC} V _{CC} = Max.	20	20	20	20	20	20	20	mA	
I _{SB1}	Full Standby Current CE ≥ V _{HC} f = 0 V _{CC} = Max., V _{IN} ≥ V _{CC} - 0.2V or ≤ 0.2V	5	5	5	5	5	5	5	mA	

NOTES: All values are maximum guaranteed values.
V_{LC} ≤ 0.2V, V_{HC} ≥ V_{CC} - 0.2V



Capacitance⁽¹⁾ ($T_A = +25^\circ\text{C}$, $f = 1.0\text{ MHz}$)

Symbol	Parameter	Max.	Unit
C_{IN}	Input Capacitance	8	pF
C_{OUT}	Output Capacitance	8	pF

NOTE:1. This parameter is determined by device characterization but is not production tested.

AC Test Conditions

Input pulse levels	V_{SS} to 3.0V
Input rise and fall times	2.5 ns
Input timing reference levels	1.5V
Output reference levels	1.5V
Output load	See Figures 1 and 2

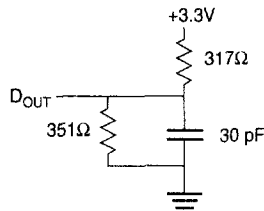

Figure 1. Output Load Equivalent

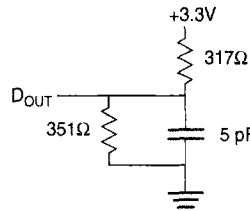

Figure 2. Output Load Equivalent
(for t_{LZCE} , t_{HZCE} , t_{LZWE} , t_{HZWE} , t_{LZOE} , t_{HZOE})

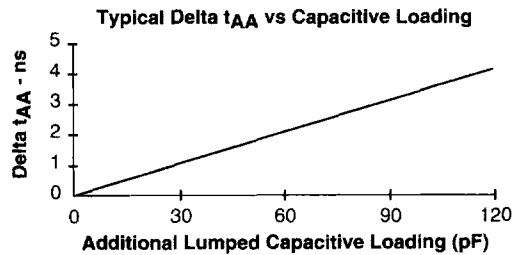
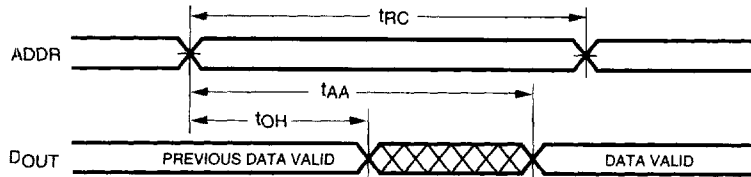
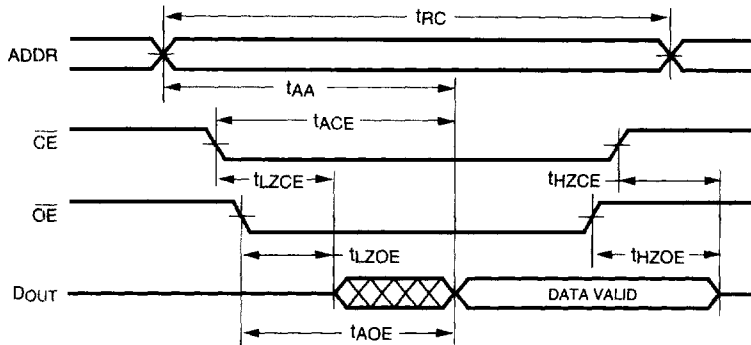

Figure 3.

Read Cycle No. 1^(4, 5)



Read Cycle No. 2^(2, 4, 6)



AC Electrical Characteristics

Description	Sym	-10		-12		-15		-20		Units
		Min.	Max.	Min.	Max.	Min.	Max.	Min.	Max.	
READ cycle time	t_{RC}	10		12		15		20		ns
Address access time	t_{AA}		10		12		15		20	ns
Chip enable access time	t_{ACE}		10		12		15		20	ns
Output hold from address change	t_{OH}	3		3		3		3		ns
Chip enable to output in low Z ^(1,3)	t_{LZCE}	3		3		3		3		ns
Chip disable to output in high Z ^(1,2,3)	t_{HZCE}		6		7		8		9	ns
Chip enable to power up time ⁽³⁾	t_{PU}	0		0		0		0		ns
Chip disable to power down time ⁽³⁾	t_{PD}		10		12		15		20	ns
Output enable access time	t_{AOE}		6		7		8		9	ns
Output enable to output in low Z ^(1,3)	t_{LZOE}	0		0		0		0		ns
Output disable to output in high Z ^(1,3)	t_{HZOE}		6		7		8		9	ns

Write Cycle No. 1 (Write Enable Controlled)

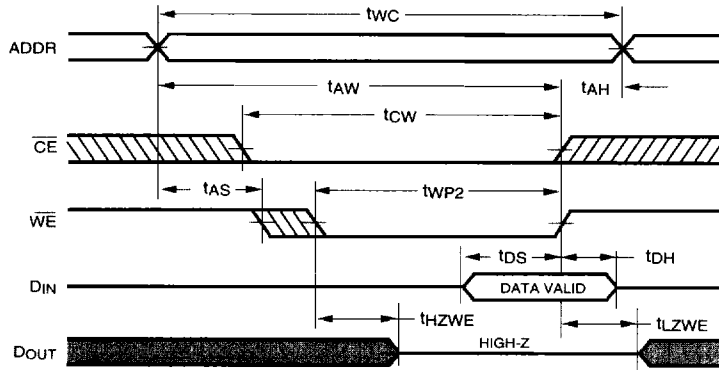

Write Cycle No. 2 (Write Enable Controlled)

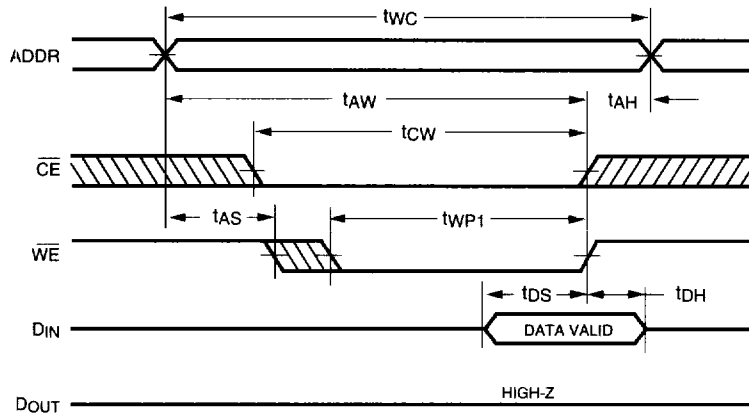

Write Cycle No. 3 (Chip Enable Controlled)

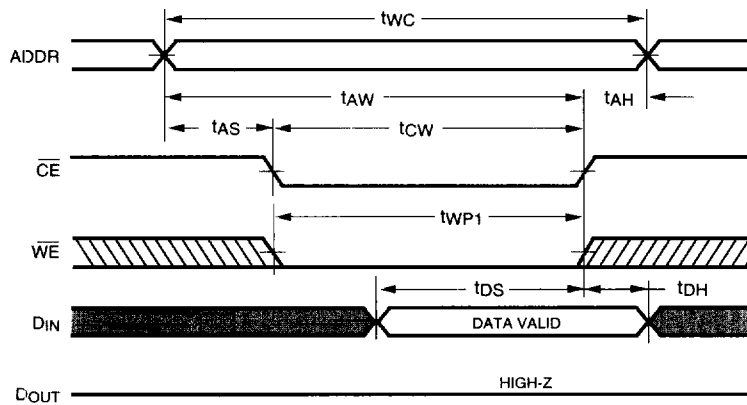

NOTE: Output Enable (\overline{OE}) is inactive (high)

AC Electrical Characteristics

Description	Sym	-10		-12		-15		-20		Units
		Min.	Max.	Min.	Max.	Min.	Max.	Min.	Max.	
WRITE Cycle										
WRITE cycle time	t _{WC}	10		12		15		20		ns
Chip enable active time	t _{CW}	9		10		11		12		ns
Address valid to end of write	t _{AW}	9		10		11		12		ns
Address setup time	t _{AS}	0		0		0		0		ns
Address hold from end of write	t _{AH}	0		0		0		0		ns
Write pulse width	t _{WP}	7		8		9		10		ns
Data setup time	t _{DS}	6		7		8		9		ns
Data hold time	t _{DH}	0		0		0		0		ns
Write disable to output in low Z ^(1,3)	t _{LZWE}	0		0		0		0		ns
Write enable to output in high ^(1,3)	t _{HZWE}		7		7		7		9	ns

NOTES: (For two previous Electrical Characteristics tables)

1. The parameter is tested with CL = 5 pF as shown in Figure 2. Transition is measured ±200 mV from steady state voltage.
2. At any given temperature and voltage condition, t_{HZCE} is less than t_{LZCE}.
3. This parameter is sampled.
4. WE is high for a READ cycle.
5. The device is continuously selected. Chip Enable is held in its active state.
6. The address is valid prior to or coincident with the latest occurring Chip Enable.



Ordering Information

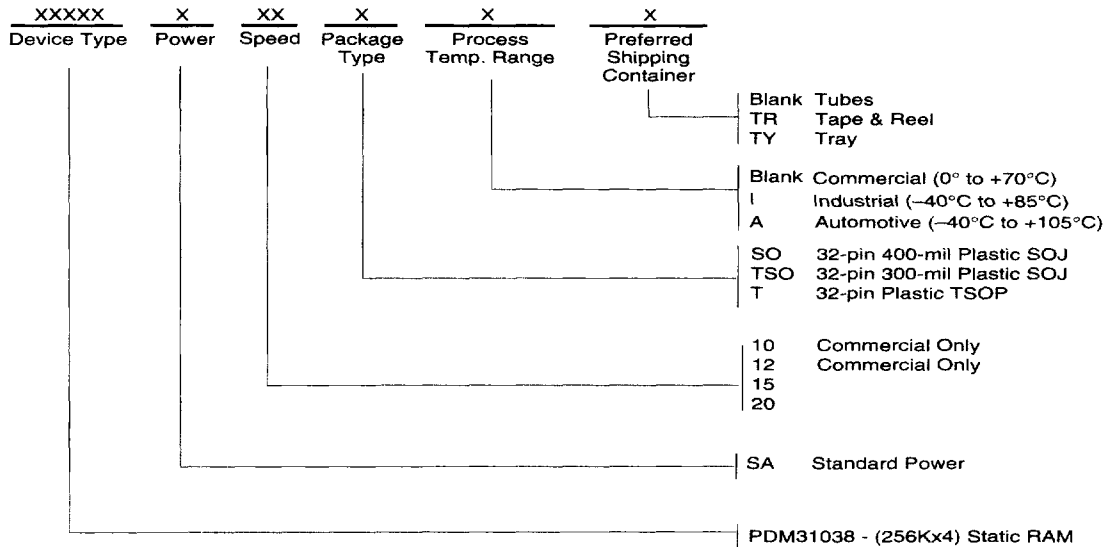

Faster Memories for a FasterWorld™