

## HD-20 Front Metal-Shell Straight Posted Connectors With ACTION PIN Contacts

### Receptacle

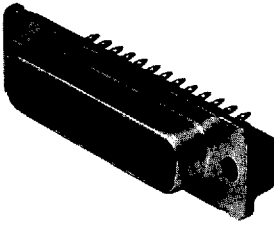

With Standard Mounting Holes



With Threaded Insert



With Fixed Female Screwlock

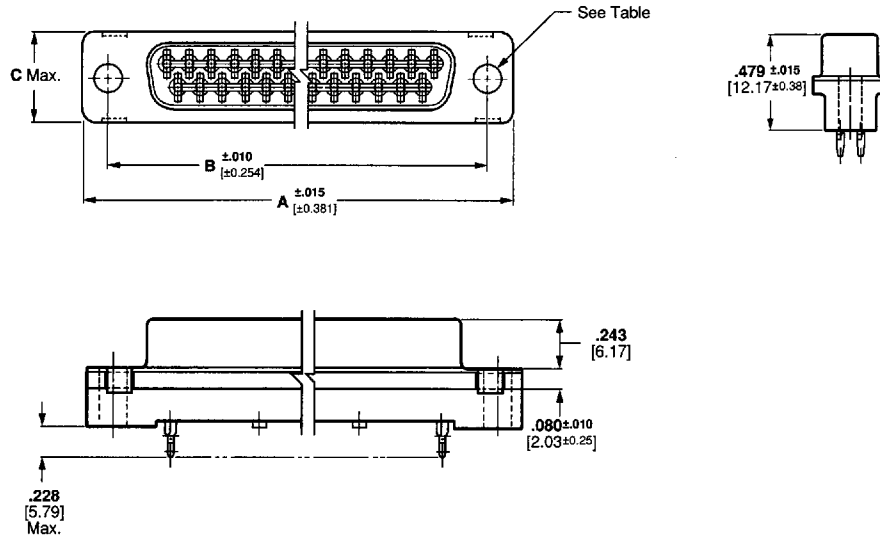

### Material and Finish:

**Front Shell**—Steel, tin plated

**Housing**—94V-0 rated thermoplastic, black

**Threaded Inserts**—Brass, unplated

**Female Screwlocks**—Zinc

**ACTION PIN Contacts**—Copper alloy, duplex plated as follows:

**A**—.000030 [0.00076] gold on mating end, tin-lead on ACTION PIN post surface, with entire contact .000050

[0.00127] (min.) nickel underplated

**B**—Gold flash on mating end, tin-lead on ACTION PIN post surface, with entire contact .000050 [0.00127] (min.) nickel underplated

### Related Product Data:

**Contact Arrangements**—page 4

**Performance Characteristics**—page 5

**Mateable Connectors:**

**HDE**—pages 18-21

**HDF**—pages 32-37

**HDP**—pages 42-43

**Mating/Panel Mounting**—page 6

**Pc Board Mounting Specifications**—page 171

### Technical Documents:

**Product Specification**—108-40014

**Application Specification**—114-40026

### For .062 [1.57] min. Thick Pc Boards

Shell Size	No. of Contact Positions	Dimensions			Contact Finish (Plating Code)	Receptacle Part Numbers			Seating Tool Part No.
		A	B	C		With Standard Mounting Holes	With Threaded Inserts	With Fixed Female Screwlocks	
1	9	1.213 30.81	.984 24.99	.509 12.93	A	—	748650-1	—	91164-2
2	15	1.541 39.14	1.312 33.32	.509 12.93	A	—	—	—	91165-2
3	25	2.088 53.04	1.852 47.04	.509 12.93	A	—	748484-2	—	91168-2
					B	—	—	—	
5	50	2.635 66.93	2.406 61.11	.620 15.75	A	—	748485-2	—	91167-2
					B	—	—	—	

### For .093 [2.36] min. Thick Pc Boards

Shell Size	No. of Contact Positions	Dimensions			Contact Finish (Plating Code)	Receptacle Part Numbers			Seating Tool Part No.
		A	B	C		With Standard Mounting Holes	With Threaded Inserts	With Fixed Female Screwlocks	
1	9	1.213 30.81	.984 24.99	.509 12.93	A	747089-2	747090-2	747091-2	91164-2
					B	—	—	747091-1	
2	15	1.541 39.14	1.312 33.32	.509 12.93	A	747140-2	747141-2	747142-2	91165-2
					B	—	—	—	
3	25	2.088 53.04	1.852 47.04	.509 12.93	A	745922-2	745925-2	745928-2	91168-2
					B	—	745925-1	745928-1	
4	37	2.729 69.32	2.500 63.50	.509 12.93	A	747713-2	747714-2	747715-2	91166-2
					B	—	747714-1	747715-1	
5	50	2.635 66.93	2.406 61.11	.620 15.75	A	747143-2	747144-2	747145-2	91167-2
					B	—	747144-1	747145-1	

**Notes:** 1. All receptacles are preloaded with straight posted ACTION PIN socket contacts.  
2. Male screw retainers (pages 82 and 83) are used as mating hardware for connectors with 4-40 female screwlocks.

## PC Board Mounting Specifications

### HD-22 Right-Angle Posted Connectors

Shell Size 1

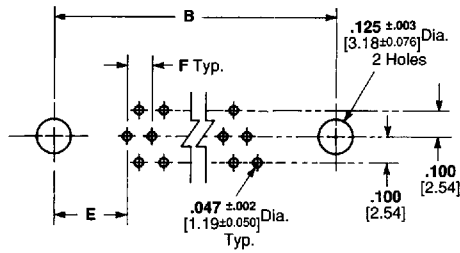

Shell Sizes 2 thru 4

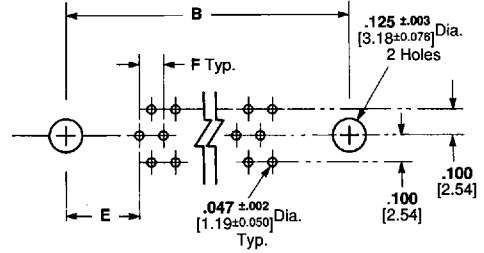

Shell Size 5

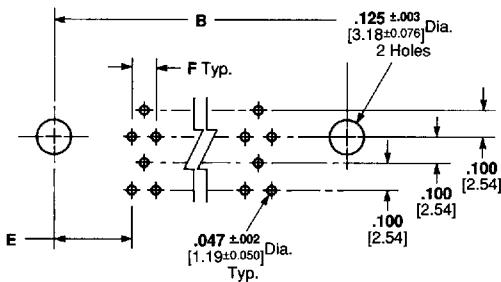

Note: PC Board layouts illustrated above serve as a guide only; they are not to be used for actual design or construction of Customer equipment. Consult AMP Incorporated for detailed pc board layouts.

Shell Size	No. of Contact Positions	Dimensions		
		B	E	F
1	15	.984 24.99	.277 7.04	.090 2.29
2	26	1.312 33.33	.271 6.88	.090 2.29
3	44	1.852 47.04	.271 6.88	.090 2.29
4	62	2.500 63.50	.2755 7.00	.095 2.41
5	78	2.406 61.11	.3005 7.63	.095 2.41

### HD-22 Vertical Posted Connectors

Shell Size 1

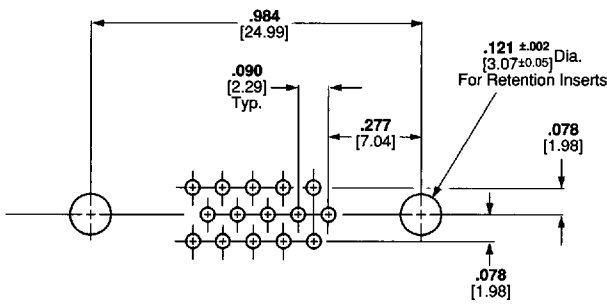

Shell Size 2

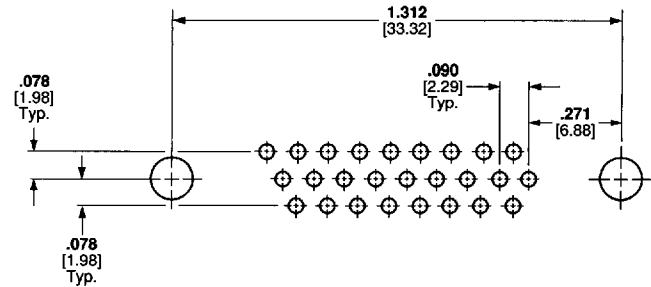

Shell Size 4

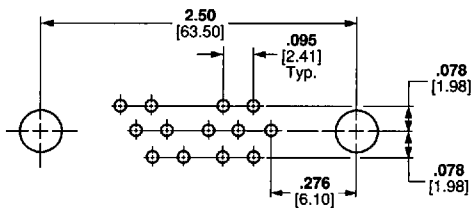

Shell Size 5

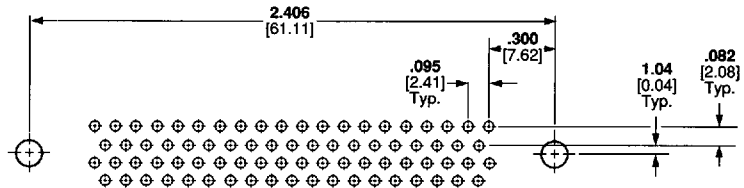

## PC Board Mounting Specifications for Connectors Without Boardlocks

### HD-20 Right-Angle and Straight Posted Connectors

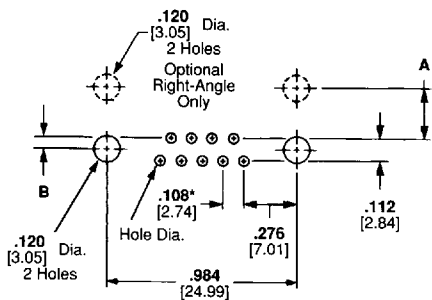

Shell Size 1 (9 Positions)

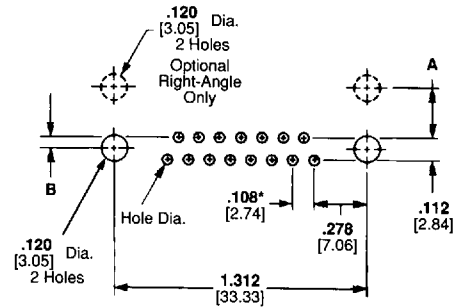

Shell Size 2 (15 Positions)

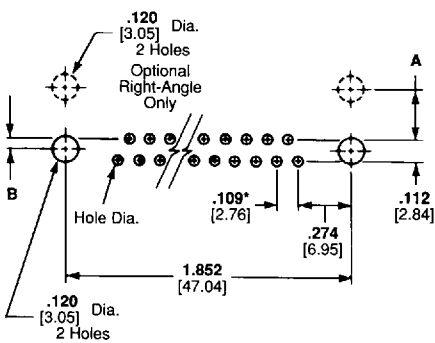

Shell Size 3 (25 Positions)

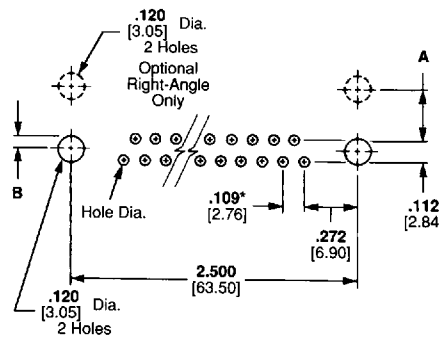

Shell Size 4 (37 Positions)

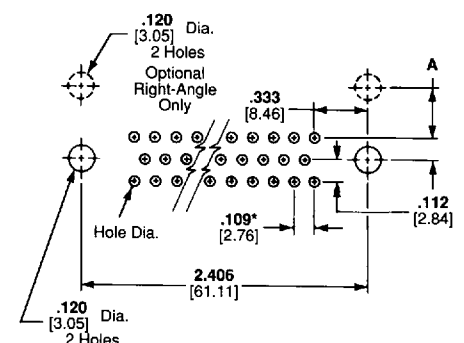

Shell Size 5 (50 Positions)

\*This dimension is non-cumulative.

Note: PC board layouts illustrated above serve as a guide only; they are not to be used for actual design or construction of customer equipment. Consult AMP customer print for detailed PC board layout requirements.

Connectors	Connector Style	Shell Size	Dimensions		Hole Dia.	Page Reference
			A	B		
Right-Angle Posted Connectors	HD-20 Full Metal-Shell with .025 [0.64] Sq. Posts 454 Mount	1, 2, 3, 4	.185 4.70	.056 1.42	.047 1.19	87
	HD-20 Full Metal-Shell with .025 [0.64] Sq. Posts 545 Mount	1, 2, 3, 4	.275 6.99	.056 1.42	.047 1.19	88, 89
		5	.275/.219 6.99/5.56	—		
	HD-20 Front Metal-Shell with .026 [0.66] Dia. Posts 318 Mount	1, 2, 3, 4	—	.056 1.42	.041 1.04	90, 91
		HD-20 Front Metal-Shell with .026 [0.66] Dia. Posts 478 Mount	1, 2, 3, 4	—		
	HD-20 Front Metal-Shell with .026 [0.66] Dia. Posts 590 Mount	1, 2, 3, 4	.275 6.99	—	.041 1.04	94, 95
	HD-20 All-Plastic 318 Mount	1, 2, 3, 4	—	.056 1.42	.041 1.04	96, 97, 98
HD-20 All-Plastic 590 Mount	1, 2, 3, 4	.275 6.99	.056 1.42	.041 1.04	99, 100, 101, 102	
Straight Posted Connectors	HD-20 Full Metal-Shell with .025 sq. Posts	1, 2, 3, 4, 5	—	—	.047 1.19	132, 133
	HD-20 Front Metal-Shell with .026 Dia. Post	1, 2, 3, 4	—	—	.041 1.04	136, 137
	HD-20 All-Plastic with .026 Dia. Post	1, 2, 3, 4, 5	—	—	.041 1.04	138, 139, 140, 141
	HD-20 Front Metal-Shell with ACTION PIN Post**	1, 2, 3, 4, 5	—	—	.043/.036 1.09/0.91	141, 142
	HD-20 All-Plastic with ACTION PIN Post**	1, 2, 3, 4, 5	—	—	.043/.036 1.09/0.91	143

\*\*PC board recommendations for ACTION PIN posts:

- A. Holes should be drilled with a 1.15 mm drill.
- B. Minimum PC board tin-lead plating to be .0003 [0.0076] thick over .002±.001 [0.05±0.025] thick copper.
- C. Recommended hole size after tin-lead plating is .037 [0.94] to .043 [1.09].
- D. If hole is reflowed after plating, diameter to be .036 [0.91] to .043 [1.09].

## HD-22 and HD-20 Commercial Connectors (AMPLIMITE)

### Contact Arrangements

#### HD-22 Inserts

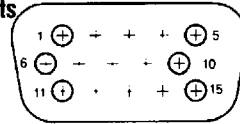

Shell Size 1  
(15 Position)

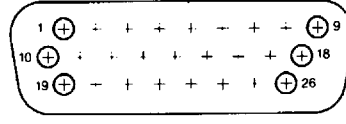

Shell Size 2  
(26 Position)

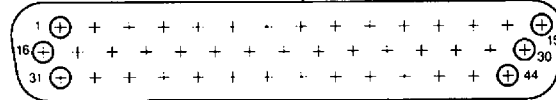

Shell Size 3  
(44 Position)

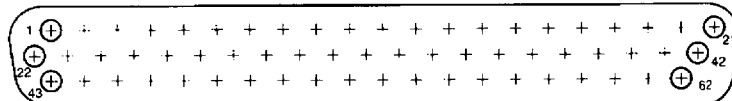

Shell Size 4  
(62 Position)

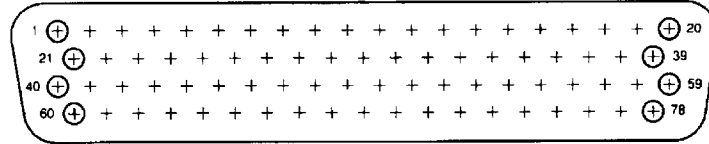

Shell Size 5  
(78 Position)

#### HD-20 Inserts

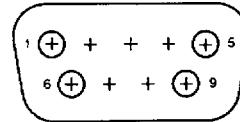

Shell Size 1  
(9 Position)

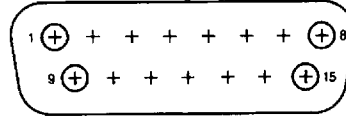

Shell Size 2  
(15 Position)

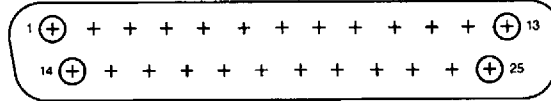

Shell Size 3  
(25 Position)

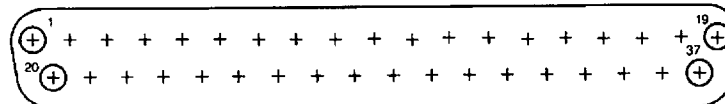

Shell Size 4  
(37 Position)

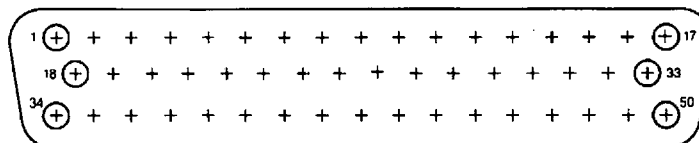

Shell Size 5

(50 Position—This cavity identification numbering does not apply to the 50 position HDF-20 connector, see next illustration.)

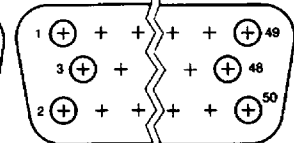

Shell Size 5

(50 Position—HDF-20 connector)

Note: Mating face of plug is shown, receptacle is mirror-image.

## HD-22 and HD-20 Connectors Performance Characteristics

### Cable Connectors

	Connector Type			
	HDP-22	HDE-20	HDF-20	HDP-20
<b>Electrical Characteristics</b>				
Contact Current Rating (One pair of contacts)	22 AWG [0.4mm <sup>2</sup> ] Wire 5.0 amperes	20 AWG [0.6mm <sup>2</sup> ] 3 amperes	26 & 28 AWG [0.15 & 0.08mm <sup>2</sup> ] Stranded and Solid Wire 1.25 amperes	20 AWG [0.6mm <sup>2</sup> ] 7.5 amperes
Termination Resistance	15 milliohms (max.)	30 milliohms (max.)	25 milliohms (max.)	15 milliohms (max.)
Dielectric Withstanding Voltage	1000 VAC min.	1000 VAC min.	500 VAC min.	1000 VAC min.
Insulation Resistance	5000 megohms min.	5000 megohms min.	5000 megohms min.	5000 megohms min.
<b>Mechanical Characteristics</b>				
Contact Insertion Force	3 lb. max. [13.34 N max.]	N/A	N/A	3 lb. max. [13.34 N max.]
Contact Retention	5 lb. min. [22.24 N min.]	7 lb. min. [31.14 N min.]	N/A	10 lb. min. [44.48 N min.]
Contact Mating Force (Per contact circuit pair)	8 oz. max. [2.22 N max.]	8 oz. max. [2.22 N max.]	12 oz. max. [3.34 N max.]	8 oz. max. [2.22 N max.]
Contact Unmating Force (Per contact circuit pair)	.75 oz. min. [0.209 N min.]	.75 oz. min. [0.209 N min.]	9-37 Position .75 oz. min. [0.209 N min.] 50 Position .40 oz. min. [0.111 N min.]	.75 oz. min. [0.209 N min.]
Tensile Strength	22 AWG—12 lb. [0.4mm <sup>2</sup> —53.4 N] 24 AWG—8 lb. [0.2mm <sup>2</sup> —35.6 N] 26 AWG—4.5 lb. [0.15mm <sup>2</sup> —20.02 N] 28 AWG—2.7 lb. [0.08mm <sup>2</sup> —12.01 N]	20 AWG—9.5 lb. [0.6mm <sup>2</sup> —42.3 N] 22 AWG—6 lb. [0.4mm <sup>2</sup> —26.7 N] 24 AWG—4 lb. [0.2mm <sup>2</sup> —17.79 N] 26 AWG—2.5 lb. [0.15mm <sup>2</sup> —11.12 N] 28 AWG—2.5 lb. [0.08mm <sup>2</sup> —11.12 N] 30 AWG—1 lb. [0.05mm <sup>2</sup> —4.45 N]	N/A	20 AWG—20 lb. [0.6mm <sup>2</sup> —89 N] 22 AWG—12 lb. [0.4mm <sup>2</sup> —53.4 N] 24 AWG—8 lb. [0.2mm <sup>2</sup> —35.6 N] 26 AWG—4.5 lb. [0.15mm <sup>2</sup> —20.02 N] 28 AWG—2.7 lb. [0.08mm <sup>2</sup> —12.01 N]
Durability	.000030 [0.00076] gold—500 cycles Gold Flash— 100 cycles	.000030 [0.00076] gold—500 cycles Gold Flash— 100 cycles	.000030 [0.00076] gold—500 cycles	.000030 [0.00076] gold—500 cycles Gold Flash— 100 cycles
<b>Environmental Characteristics</b>				
Vibration	Random 20 G's rms max.	Random 20 G's rms max.	Random 16.4 G's rms max.	Random 20 G's rms max.
Physical Shock	50 G's Duration 11 ms	50 G's Duration 11 ms	50 G's Duration 11 ms	50 G's Duration 11 ms

### Board Mount Connectors

	Connector Type	
	HD-22	HD-20
<b>Electrical Characteristics</b>		
Single Contact Current Rating (30°C Rise) Duration 11 ms	2.0 amperes	18 AWG 6.0 amperes 24 AWG 4.3 amperes 28 AWG 2.9 amperes
Termination Resistance	20 milliohms (max.)	15 milliohms* (max.)
Dielectric Withstanding Voltage	1000 VAC min.	1000 VAC min.**
Insulation Resistance	5000 megohms min.	5000 megohms min.

\*Stacked Connectors—30 milliohms (max.)

\*\*Stacked Connectors—500 VAC min.

	Connector Type		
	HD-22	HD-20	HD-20
<b>Mechanical Characteristics</b>			
Durability	.000030 [0.00076] gold—500 cycles Gold flash— 100 cycles	.000030 [0.00076] gold—500 cycles Gold flash— 100 cycles	.000030 [0.00076] gold—500 cycles Gold flash— 100 cycles
Connector Mating and Unmating Force (lbs. max. over [N max.])	Size	HD-22 Without Grounding Indents	HD-20 Without Grounding Indents
	1	7.5 [33.4]	4.5 [20.02]
	2	13.0 [57.8]	7.5 [33.4]
	3	22.0 [97.9]	12.5 [55.6]
	4	31.0 [137.9]	18.5 [82.3]
	5	39.0 [173.5]	25.0 [111.2]
			HD-20 With Grounding Indents
			30.0 [133.5]
			33.0 [146.8]
			37.0 [164.6]
			40.0 [177.9]
			44.0 [195.7]

## Plug/Receptacle Mating and Panel Mounting Specifications

### Plug/Receptacle Mating

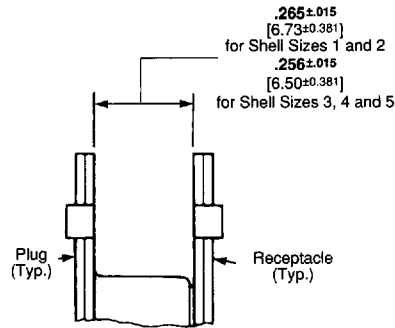

The .265 [6.73] dimension is required to assure full mating of connector halves. This dimension must be taken into consideration when determining the method of mounting, panel thickness, etc.

### Panel Mounting

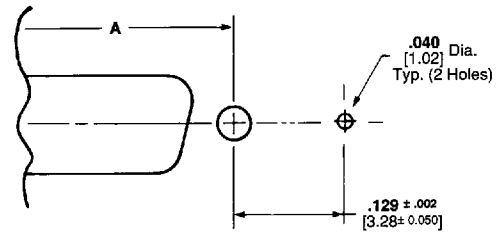
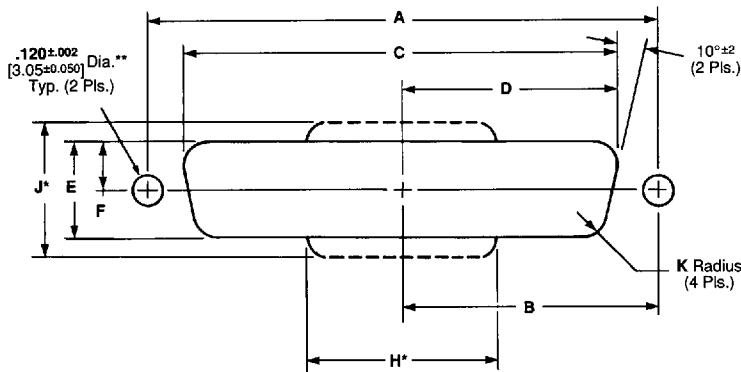

Cutout for Rear Mount and Short Latching Block

Note: Cutouts are for either plug or receptacle, front or rear panel mount.

Most plugs and receptacles can be mounted to a panel from either the front or rear, using a variety of accessory hardware. Posted receptacles are rear panel mounted only. Typical examples are shown below.

Shell Size (Pos.)	Mounting Method Front/Rear Panel	Dimensions								
		A	B	C	D	E	F	H*	J*	K
1 (9)	Front	.984 24.99	.492 12.50	.874 22.20	.437 11.10	.513 13.03	.257 6.53	—	—	.083 2.11
	Rear	.984 24.99	.492 12.50	.806 20.47	.403 10.24	.449 11.41	.225 5.72	.550 13.97	.750 19.05	.132 3.35
2 (15)	Front	1.312 33.33	.656 16.66	1.202 30.53	.601 15.27	.513 13.03	.257 6.53	—	—	.083 2.11
	Rear	1.312 33.33	.656 16.66	1.134 28.80	.567 14.40	.449 11.41	.225 5.72	.730 18.54	.750 19.05	.132 3.35
3 (25)	Front	1.852 47.04	.926 23.52	1.743 44.27	.872 22.15	.513 13.03	.257 6.53	—	—	.083 2.11
	Rear	1.852 47.04	.926 23.52	1.674 42.52	.842 21.39	.449 11.41	.225 5.72	1.275 32.39	.750 19.05	.132 3.35
4 (37)	Front	2.500 63.50	1.250 31.75	2.391 60.73	1.196 30.38	.513 13.03	.257 6.53	—	—	.083 2.11
	Rear	2.500 63.50	1.250 31.75	2.326 59.08	1.163 29.54	.449 11.41	.225 5.72	1.920 46.05	.750 16.13	.132 3.35
5 (50)	Front	2.406 61.11	1.203 30.56	2.297 58.34	1.149 29.19	.623 15.82	.312 7.93	—	—	.083 2.11
	Rear	2.406 61.11	1.203 30.56	2.218 56.34	1.109 28.17	.555 14.10	.278 7.06	1.753 44.52	.750 19.05	.132 3.35

\*Panel cutout configuration with H and J dimensions provides clearance for mounting connectors with cable clamps.  
\*\*This dimension is  $.190 \pm .002$  [4.83 $\pm$ 0.05] when posted connectors with fixed female screwlocks are rear-panel mounted.

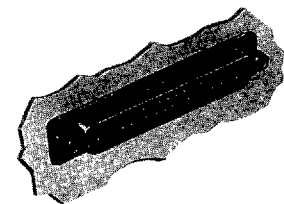

Typical Front-Panel Mounted Subminiature D Plug

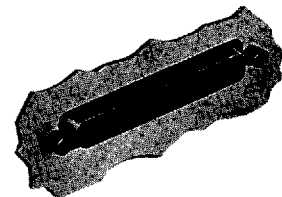

Typical Rear-Panel Mounted Subminiature D Receptacle

## PC Board Mounting Specifications for Connectors With Boardlocks

### AMPLIMITE III HD-20 Right-Angle Posted Connectors

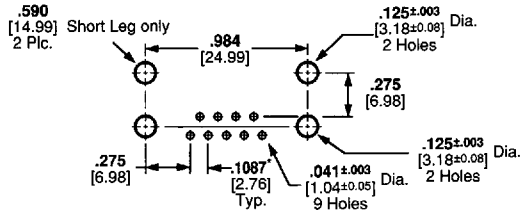

Shell Size 1 (9 Positions)

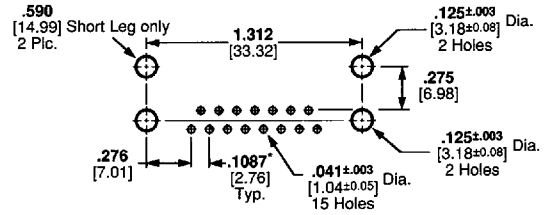

Shell Size 2 (15 Positions)

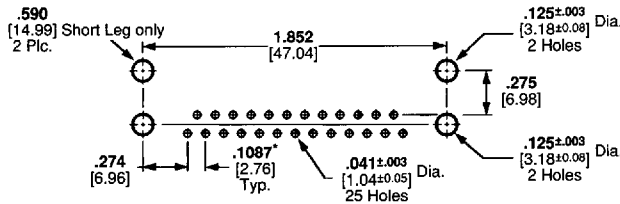

Shell Size 3 (25 Positions)

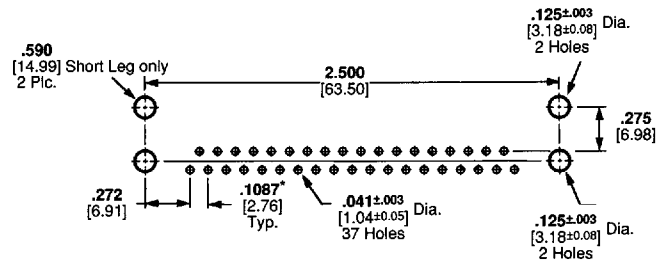

Shell Size 4 (37 Positions)

\*This dimension is non-cumulative.

- Notes:**
1. All receptacles are preloaded with size 20 DF socket contacts.
  2. Recommended pc board thickness is .062 [1.57] for connectors with boardlocks and .093 [2.36] max. for all others.
  3. Pc board layouts illustrated above serve as a guide only; they are not to be used for actual design or construction of customer equipment. Consult AMP customer print for detailed pc board layout requirements.

### HD-20 Right-Angle Stacked Connectors

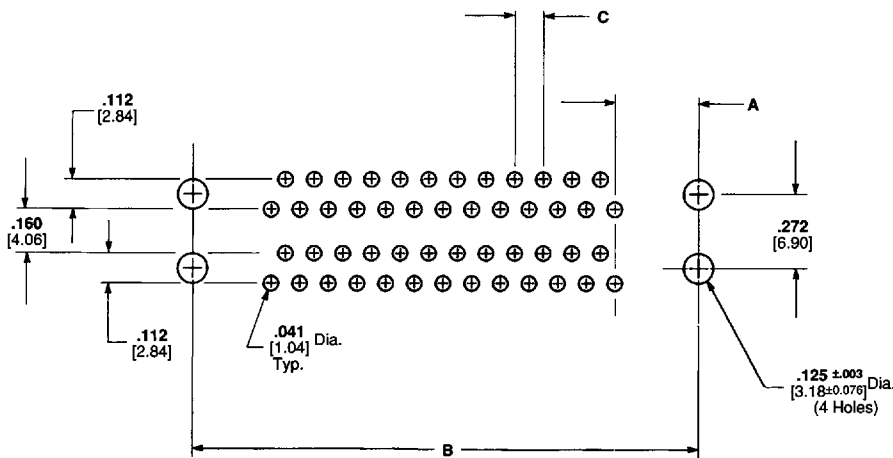

No. of Contact Positions	Dimensions		
	A	B	C
18	.276 7.01	.984 24.99	.108 2.74
30	.278 7.06	1.312 33.33	.108 2.74
50	.274 6.96	1.852 47.04	.109 2.77
74	.272 6.91	2.500 63.50	.109 2.77