

Glass Passivated Single-Phase Bridge Rectifier

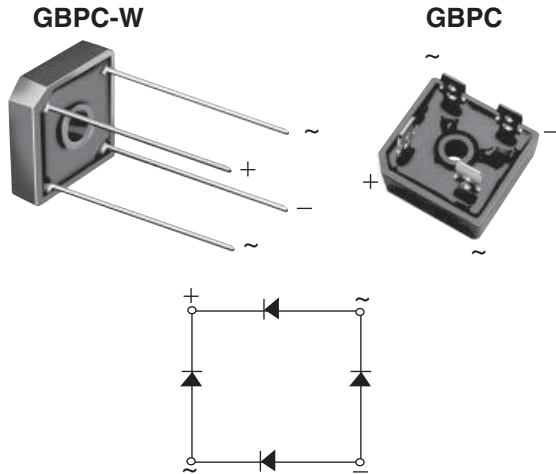

FEATURES

- UL recognition file number E54214
- Universal 3-way terminals: snap-on, wire wrap-around, or PCB mounting
- Typical I_R less than 0.3 μA
- High surge current capability
- Low thermal resistance
- Solder dip 275 °C max. 10 s, per JESD 22-B106
- Material categorization: For definitions of compliance please see www.vishay.com/doc?99912



RoHS
COMPLIANT
HALOGEN
FREE

TYPICAL APPLICATIONS

General purpose use in AC/DC bridge full wave rectification for power supply, home appliances, office equipment, industrial automation applications.

MECHANICAL DATA

Case: GBPC, GBPC-W

Molding compound meets UL 94 V-0 flammability rating Base P/N-M4 - halogen-free, RoHS-compliant, and commercial grade

Terminals: Nickel plated on faston lugs or silver plated on wire leads, solderable per J-STD-002 and JESD22-B102. Suffix letter "W" added to indicate wire leads (e.g. GBPC12005W).

Polarity: As marked, positive lead by beveled corner

Mounting Torque: 20 inches-lbs. max.

PRIMARY CHARACTERISTICS

| Package | GBPC, GBPC-W |
|------------------|----------------------------|
| $I_{F(AV)}$ | 12 A, 15 A, 25 A, 35 A |
| V_{RRM} | 50 V to 1000 V |
| I_{FSM} | 200 A, 300 A, 300 A, 400 A |
| I_R | 5 μA |
| V_F at I_F | 1.1 V |
| T_J max. | 150 °C |
| Diode variations | Quad |

MAXIMUM RATINGS ($T_A = 25$ °C unless otherwise noted)

| PARAMETER | SYMBOL | GBPC12, 15, 25, 35 | | | | | | | UNIT | |
|--|----------------|--------------------|-----|-----|-----|-----|-----|------|------|------------------|
| | | 005 | 01 | 02 | 04 | 06 | 08 | 10 | | |
| Maximum repetitive peak reverse voltage | V_{RRM} | 50 | 100 | 200 | 400 | 600 | 800 | 1000 | V | |
| Maximum RMS voltage | V_{RMS} | 35 | 70 | 140 | 280 | 420 | 560 | 700 | V | |
| Maximum DC blocking voltage | V_{DC} | 50 | 100 | 200 | 400 | 600 | 800 | 1000 | V | |
| Maximum average forward rectified output current (Fig. 1) | $I_{F(AV)}$ | GBPC12 | 12 | | | | | | | A |
| | | GBPC15 | 15 | | | | | | | |
| | | GBPC25 | 25 | | | | | | | |
| | | GBPC35 | 35 | | | | | | | |
| Peak forward surge current single sine-wave superimposed on rated load | I_{FSM} | GBPC12 | 200 | | | | | | | A |
| | | GBPC15 | 300 | | | | | | | |
| | | GBPC25 | 300 | | | | | | | |
| | | GBPC35 | 400 | | | | | | | |
| Rating (non-repetitive, for t greater than 1 ms and less than 8.3 ms) for fusing | I^2t | GBPC12 | 160 | | | | | | | A ² s |
| | | GBPC15 | 375 | | | | | | | |
| | | GBPC25 | 375 | | | | | | | |
| | | GBPC35 | 660 | | | | | | | |
| RMS isolation voltage from case to leads | V_{ISO} | 2500 | | | | | | | V | |
| Operating junction storage temperature range | T_J, T_{STG} | - 55 to + 150 | | | | | | | °C | |



ELECTRICAL CHARACTERISTICS (T_A = 25 °C unless otherwise noted)

| PARAMETER | TEST CONDITIONS | SYMBOL | GBPC12, 15, 25, 35 | | | | | | UNIT | |
|---|-------------------------|-------------------------|--------------------|-----|----|----|----|----|------|----|
| | | | 005 | 01 | 02 | 04 | 06 | 08 | | 10 |
| Maximum instantaneous forward drop per diode | GBPC12 | I _F = 6.0 A | V _F | 1.1 | | | | | | V |
| | GBPC15 | I _F = 7.5 A | | | | | | | | |
| | GBPC25 | I _F = 12.5 A | | | | | | | | |
| | GBPC35 | I _F = 17.5 A | | | | | | | | |
| Maximum reverse DC current at rated DC blocking voltage per diode | T _A = 25 °C | | I _R | 5.0 | | | | | | μA |
| | T _A = 125 °C | | | 500 | | | | | | |
| Typical junction capacitance per diode | 4 V, 1 MHz | | C _J | 300 | | | | | | pF |

THERMAL CHARACTERISTICS (T_A = 25 °C unless otherwise noted)

| PARAMETER | SYMBOL | GBPC12, 15, 25, 35 | | | | | | UNIT | | |
|----------------------------|------------------|--------------------|---------------------------------|-----|----|----|----|------|----|------|
| | | 005 | 01 | 02 | 04 | 06 | 08 | | 10 | |
| Typical thermal resistance | GBPC12 to GBPC25 | | R _{θJC} ⁽¹⁾ | 1.9 | | | | | | °C/W |
| | GBPC35 | | | 1.4 | | | | | | |

Notes

- (1) With heatsink
- (2) Bolt down on heatsink with silicone thermal compound between bridge and mounting surface for maximum heat transfer with #10 screw

ORDERING INFORMATION (Example)

| PREFERRED P/N | UNIT WEIGHT (g) | PREFERRED PACKAGE CODE | BASE QUANTITY | DELIVERY MODE |
|-----------------|-----------------|------------------------|---------------|---------------|
| GBPC1206-M4/51 | 15.79 | 51 | 100 | Paper box |
| GBPC1506-M4/51 | 15.79 | 51 | 100 | Paper box |
| GBPC2506-M4/51 | 15.79 | 51 | 100 | Paper box |
| GBPC3506-M4/51 | 15.79 | 51 | 100 | Paper box |
| GBPC1206W-M4/51 | 13.8 | 51 | 100 | Paper box |
| GBPC1506W-M4/51 | 13.8 | 51 | 100 | Paper box |
| GBPC2506W-M4/51 | 13.8 | 51 | 100 | Paper box |
| GBPC3506W-M4/51 | 13.8 | 51 | 100 | Paper box |

RATINGS AND CHARACTERISTICS CURVES ($T_A = 25\text{ }^\circ\text{C}$ unless otherwise noted)

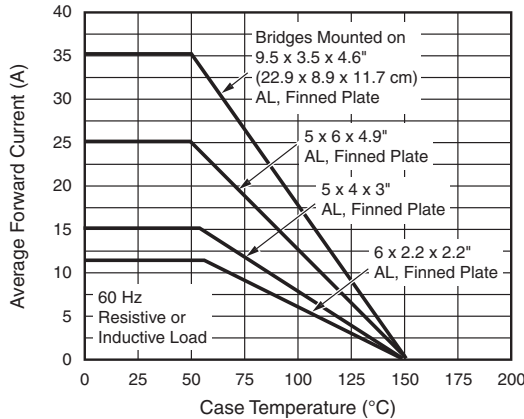

Fig. 1 - Maximum Output Rectified Current

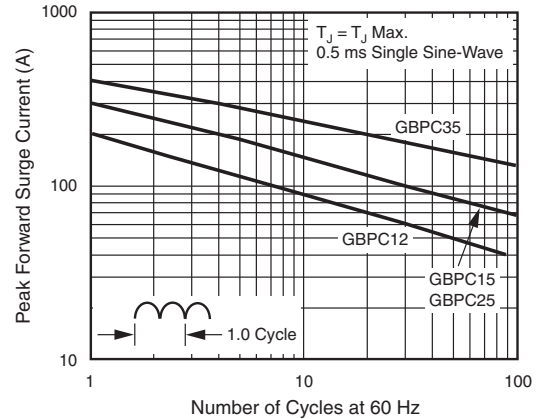

Fig. 4 - Maximum Non-Repetitive Peak Forward Surge Current Per Diode

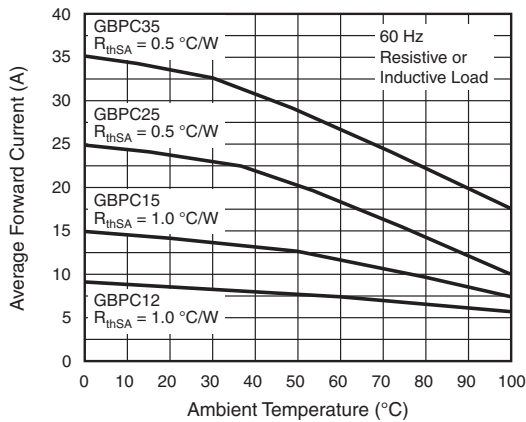

Fig. 2 - Maximum Output Rectified Current

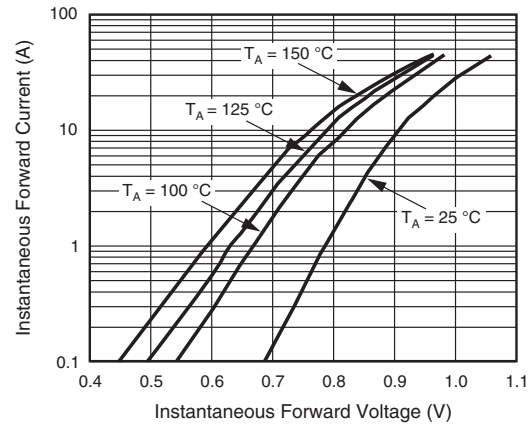

Fig. 5 - Typical Instantaneous Forward Characteristics Per Diode

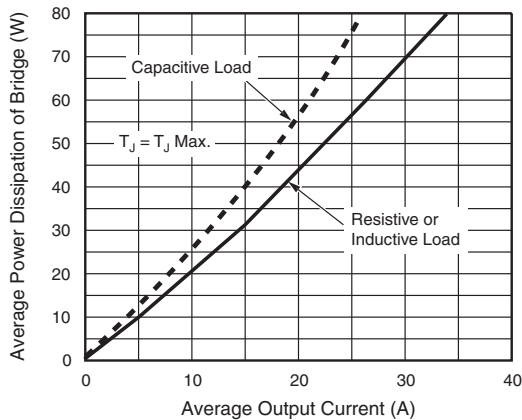

Fig. 3 - Maximum Power Dissipation

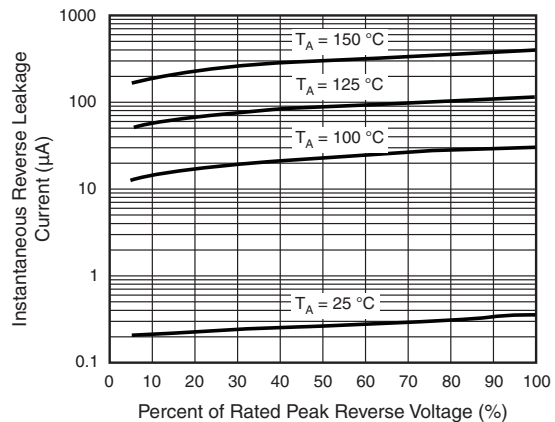

Fig. 6 - Typical Reverse Leakage Characteristics Per Diode

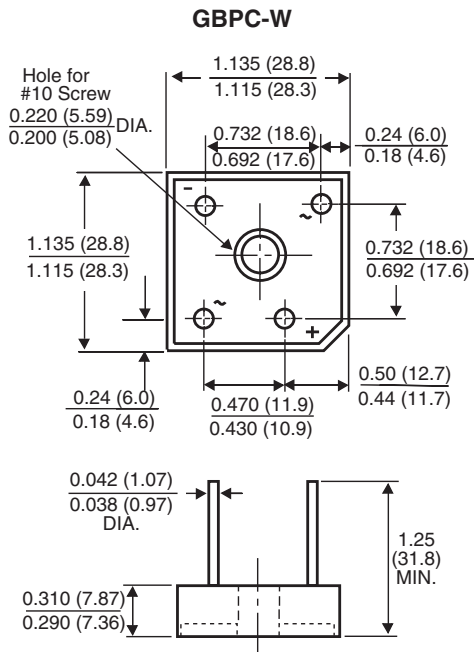

Fig. 7 - Typical Junction Capacitance Per Diode



Fig. 8 - Typical Transient Thermal Impedance Per Diode

PACKAGE OUTLINE DIMENSIONS in inches (millimeters)





Disclaimer

ALL PRODUCT, PRODUCT SPECIFICATIONS AND DATA ARE SUBJECT TO CHANGE WITHOUT NOTICE TO IMPROVE RELIABILITY, FUNCTION OR DESIGN OR OTHERWISE.

Vishay Intertechnology, Inc., its affiliates, agents, and employees, and all persons acting on its or their behalf (collectively, "Vishay"), disclaim any and all liability for any errors, inaccuracies or incompleteness contained in any datasheet or in any other disclosure relating to any product.

Vishay makes no warranty, representation or guarantee regarding the suitability of the products for any particular purpose or the continuing production of any product. To the maximum extent permitted by applicable law, Vishay disclaims (i) any and all liability arising out of the application or use of any product, (ii) any and all liability, including without limitation special, consequential or incidental damages, and (iii) any and all implied warranties, including warranties of fitness for particular purpose, non-infringement and merchantability.

Statements regarding the suitability of products for certain types of applications are based on Vishay's knowledge of typical requirements that are often placed on Vishay products in generic applications. Such statements are not binding statements about the suitability of products for a particular application. It is the customer's responsibility to validate that a particular product with the properties described in the product specification is suitable for use in a particular application. Parameters provided in datasheets and/or specifications may vary in different applications and performance may vary over time. All operating parameters, including typical parameters, must be validated for each customer application by the customer's technical experts. Product specifications do not expand or otherwise modify Vishay's terms and conditions of purchase, including but not limited to the warranty expressed therein.

Except as expressly indicated in writing, Vishay products are not designed for use in medical, life-saving, or life-sustaining applications or for any other application in which the failure of the Vishay product could result in personal injury or death. Customers using or selling Vishay products not expressly indicated for use in such applications do so at their own risk. Please contact authorized Vishay personnel to obtain written terms and conditions regarding products designed for such applications.

No license, express or implied, by estoppel or otherwise, to any intellectual property rights is granted by this document or by any conduct of Vishay. Product names and markings noted herein may be trademarks of their respective owners.

Material Category Policy

Vishay Intertechnology, Inc. hereby certifies that all its products that are identified as RoHS-Compliant fulfill the definitions and restrictions defined under Directive 2011/65/EU of The European Parliament and of the Council of June 8, 2011 on the restriction of the use of certain hazardous substances in electrical and electronic equipment (EEE) - recast, unless otherwise specified as non-compliant.

Please note that some Vishay documentation may still make reference to RoHS Directive 2002/95/EC. We confirm that all the products identified as being compliant to Directive 2002/95/EC conform to Directive 2011/65/EU.

Vishay Intertechnology, Inc. hereby certifies that all its products that are identified as Halogen-Free follow Halogen-Free requirements as per JEDEC JS709A standards. Please note that some Vishay documentation may still make reference to the IEC 61249-2-21 definition. We confirm that all the products identified as being compliant to IEC 61249-2-21 conform to JEDEC JS709A standards.