

9334/DM9334 8-Bit Addressable Latch

General Description

The DM9334 is a high speed 8-bit Addressable Latch designed for general purpose storage applications in digital systems. It is a multifunctional device capable of storing single line data in eight addressable latches, and being a one-of-eight decoder and demultiplexer with active level high outputs. The device also incorporates an active level low common clear for resetting all latches, as well as an active level low enable.

The DM9334 has four modes of operation which are shown in the mode selection table. In the addressable latch mode, data on the data line (D) is written into the addressed latch. The addressed latch will follow the data input with all non-addressed latches remaining in their previous states. In the memory mode, all latches remain in their previous state and are unaffected by the data or address inputs.

In the one-of-eight decoding or demultiplexing mode, the addressed output will follow the state of the D input with all other inputs in the low state. In the clear mode all outputs are low and unaffected by the address and data inputs.

When operating the device as an addressable latch, changing more than one bit of the address could impose a transient wrong address. Therefore, this should only be done while in the memory mode.

The function tables summarize the operation of the product.

Features

- Common clear
- Easily expandable
- Random (addressable) data entry
- Serial to parallel capability
- 8 bits of storage/output of each bit available
- Active high demultiplexing/decoding capability
- Alternate Military/Aerospace device (9334) is available. Contact a Fairchild Semiconductor Sales Office/Distributor for specifications.

Connection Diagram

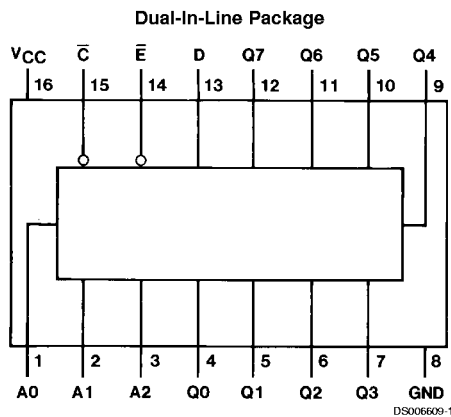

Order Number 9334DMQB, 9334FMQB, DM9334J or DM9334N
See Package Number J16A, N16E or W16A

Absolute Maximum Ratings (Note 1)

Supply Voltage	7V	Military	-55°C to +125°C
Input Voltage	5.5V	Commercial	0° to +70°C
Operating Free Air Temperature Range		Storage Temperature Range	-65°C to +150°C

Recommended Operating Conditions

Symbol	Parameter	Military			Commercial			Units
		Min	Nom	Max	Min	Nom	Max	
V _{CC}	Supply Voltage	4.5	5	5.5	4.75	5	5.25	V
V _{IH}	High Level Input Voltage	2			2			V
V _{IL}	Low Level Input Voltage			0.8			0.8	V
I _{OH}	High Level Output Current			-0.8			-0.8	mA
I _{OL}	Low Level Output Current			16			16	mA
t _w	ENABLE Pulse Width (Figure 1) (Note 5)	19	13		19	13		ns
t _{SU}	Setup Time (Note 5)	Data 1 (Figure 5)	20	13		20	13	ns
		Data 0 (Figure 5)	20	14		20	14	
		Address (Figure 6) (Note 2)	10	5		10	5	
t _H	Hold Time (Note 5)	Data 1 (Figure 5)	0	-10		0	-10	ns
		Data 0 (Figure 5)	0	-13		0	-13	
T _A	Free Air Operating Temperature	-55		125	0		70	°C

Note 1: The "Absolute Maximum Ratings" are those values beyond which the safety of the device cannot be guaranteed. The device should not be operated at these limits. The parametric values defined in the "Electrical Characteristics" table are not guaranteed at the absolute maximum ratings. The "Recommended Operating Conditions" table will define the conditions for actual device operation.

Electrical Characteristics

over recommended operating free air temperature range (unless otherwise noted)

Symbol	Parameter	Conditions	Min	Typ (Note 3)	Max	Units
V _I	Input Clamp Voltage	V _{CC} = Min, I _I = -12 mA			-1.5	V
V _{OH}	High Level Output Voltage	V _{CC} = Min, I _{OH} = Max V _{IL} = Max, V _{IH} = Min	2.4	3.6		V
V _{OL}	Low Level Output Voltage	V _{CC} = Min, I _{OL} = Max V _{IH} = Min, V _{IL} = Max		0.2	0.4	V
I _I	Input Current @ Max Input Voltage	V _{CC} = Max, V _I = 5.5V			1	mA
I _{IH}	High Level Input Current	V _{CC} = Max V _I = 2.4V	\bar{E} Input		60	μA
			Others		40	
I _{IL}	Low Level Input Current	V _{CC} = Max V _I = 0.4V	\bar{E} Input		-2.4	mA
			Others		-1.6	
I _{OS}	Short Circuit Output Current	V _{CC} = Max (Note 4)	MIL	-30	-100	mA
			COM	-30	-100	
I _{CC}	Supply Current	V _{CC} = Max		56	86	mA

Note 2: The ADDRESS setup time is the time before the negative ENABLE transition that the ADDRESS must be stable so that the correct latch is addressed without affecting the other latches.

Note 3: All typicals are at V_{CC} = 5V, T_A = 25°C.

Note 4: Not more than one output should be shorted at a time, and the duration should not exceed one second.

Note 5: T_A = 25°C and V_{CC} = 5V.

Switching Characteristics

at $V_{CC} = 5V$ and $T_A = 25^\circ C$ (for Test Waveforms and Output Load)

Symbol	Parameter	From (Input) To (Output)	$R_L = 400\Omega, C_L = 15\text{ pF}$		Units
			Min	Max	
t_{PLH}	Propagation Delay Time Low to High Level Output	Enable to Output, (Figure 1)		28	ns
t_{PHL}	Propagation Delay Time High to Low Level Output	Enable to Output, (Figure 1)		27	ns
t_{PLH}	Propagation Delay Time Low to High Level Output	Data to Output, (Figure 4)		35	ns
t_{PHL}	Propagation Delay Time High to Low Level Output	Data to Output, (Figure 4)		28	ns
t_{PLH}	Propagation Delay Time Low to High Level Output	Address to Output, (Figure 2)		35	ns
t_{PHL}	Propagation Delay Time High to Low Level Output	Address to Output, (Figure 2)		35	ns
t_{PHL}	Propagation Delay Time High to Low Level Output	Clear to Output, (Figure 3)		31	ns

Function Tables

\bar{E}	\bar{C}	Mode
L	H	Addressable Latch
H	H	Memory
L	L	Active High Eight Channel Demultiplexer
H	L	Clear

Inputs			Present Output States										Mode	
\bar{C}	\bar{E}	D	A0	A1	A2	Q0	Q1	Q2	Q3	Q4	Q5	Q6	Q7	
L	H	X	X	X	X	L	L	L	L	L	L	L	L	Clear
L	L	L	L	L	L	L	L	L	L	L	L	L	L	Demultiplex
L	L	H	L	L	L	H	L	L	L	L	L	L	L	
L	L	L	H	L	L	L	L	L	L	L	L	L	L	
L	L	H	H	L	L	L	H	L	L	L	L	L	L	
•	•	•		•					•					
•	•	•		•					•					
L	L	H	H	H	H	L	L	L	L	L	L	L	H	
H	H	X	X	X	X	Q_{N-1}								Memory
H	L	L	L	L	L	L	Q_{N-1}	Q_{N-1}	Q_{N-1}					Addressable Latch
H	L	H	L	L	L	H	Q_{N-1}	Q_{N-1}						
H	L	L	H	L	L	Q_{N-1}	L	Q_{N-1}						
H	L	H	H	L	L	Q_{N-1}	H	Q_{N-1}						
•	•	•		•					•					
•	•	•		•					•					
H	L	L	H	H	H	Q_{N-1}						Q_{N-1}	L	
H	L	H	H	H	H	Q_{N-1}						Q_{N-1}	H	

X = Don't Care Condition
L = Low Voltage Level
H = High Voltage Level
 Q_{N-1} = Previous Output State

Logic Diagram

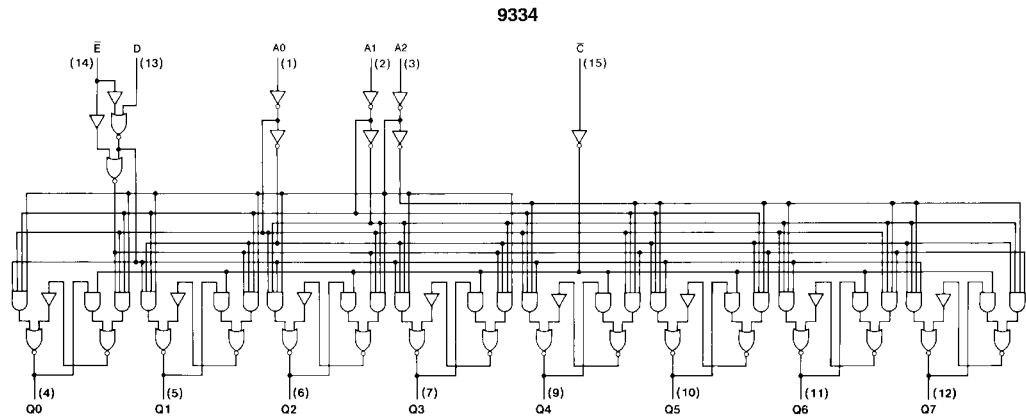

Switching Time Waveforms

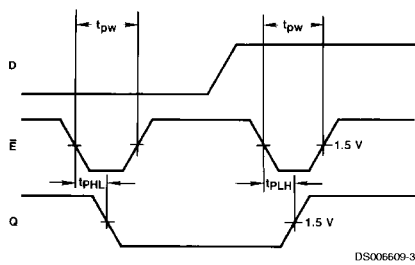

Other Conditions: C = H, A = Stable

FIGURE 1.

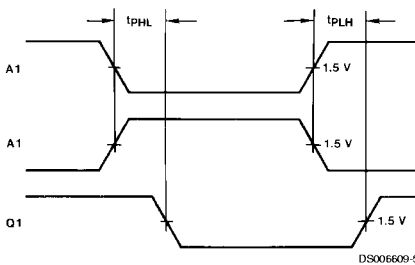

Other Conditions: E-bar = L, C-bar = L, D = H

FIGURE 2.

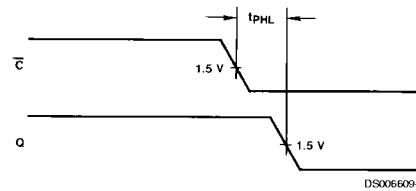

Other Conditions: E-bar = H

FIGURE 3.

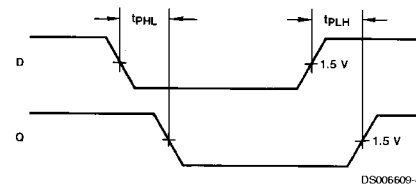

Other Conditions: E-bar = L, C-bar = H, A = Stable

FIGURE 4.

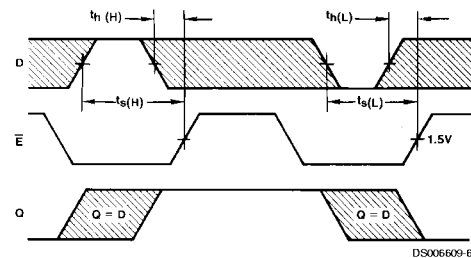

Other Conditions: C = H, A = Stable

FIGURE 5.

Switching Time Waveforms (Continued)

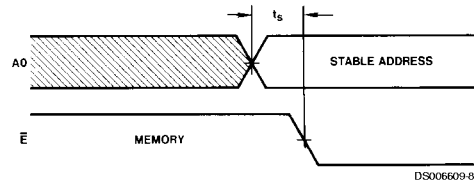

Other Conditions: $\bar{C} = H$

Note:

The shaded areas indicate when the inputs are permitted to change for predictable output performance.

FIGURE 6.

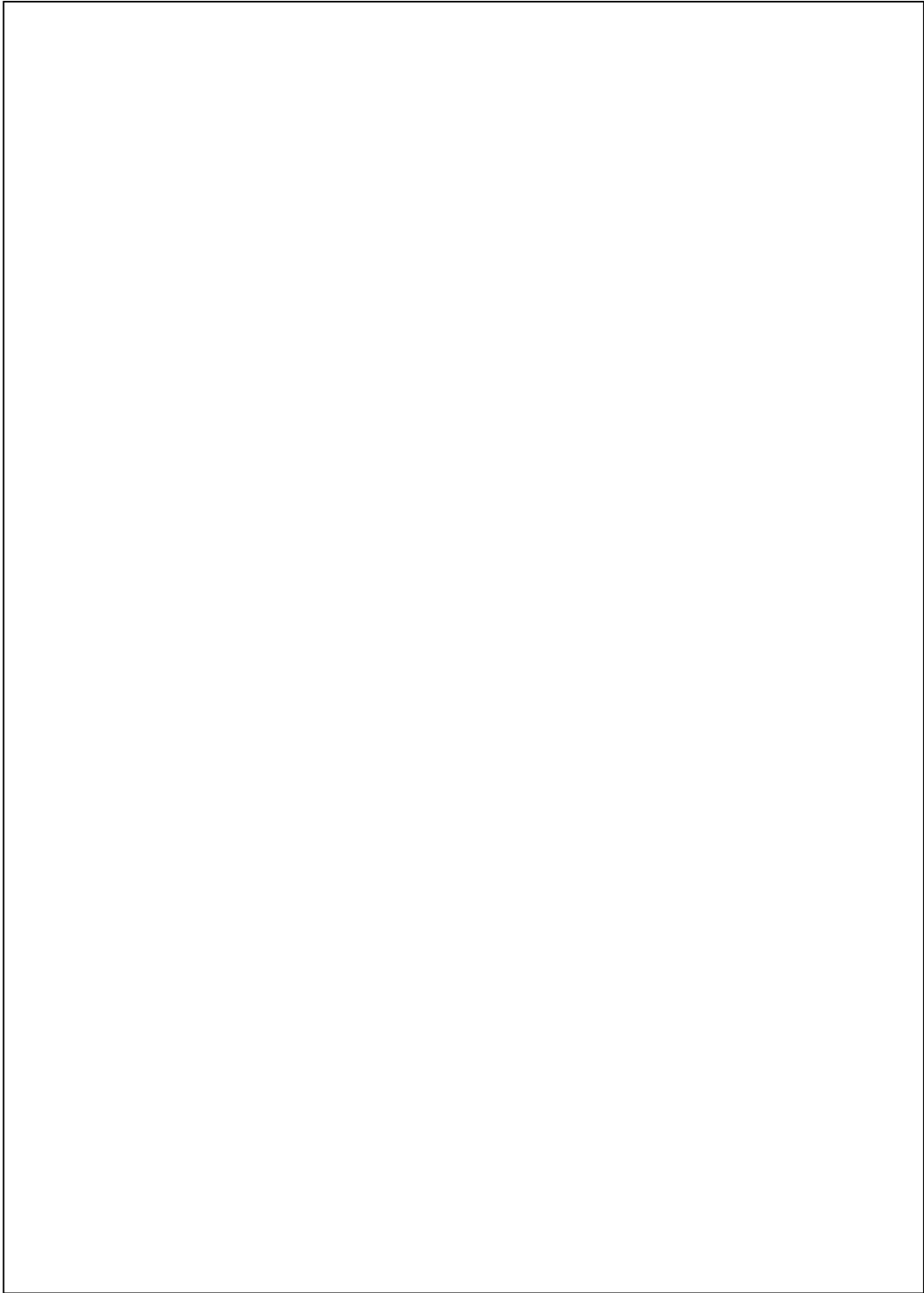

Physical Dimensions inches (millimeters) unless otherwise noted

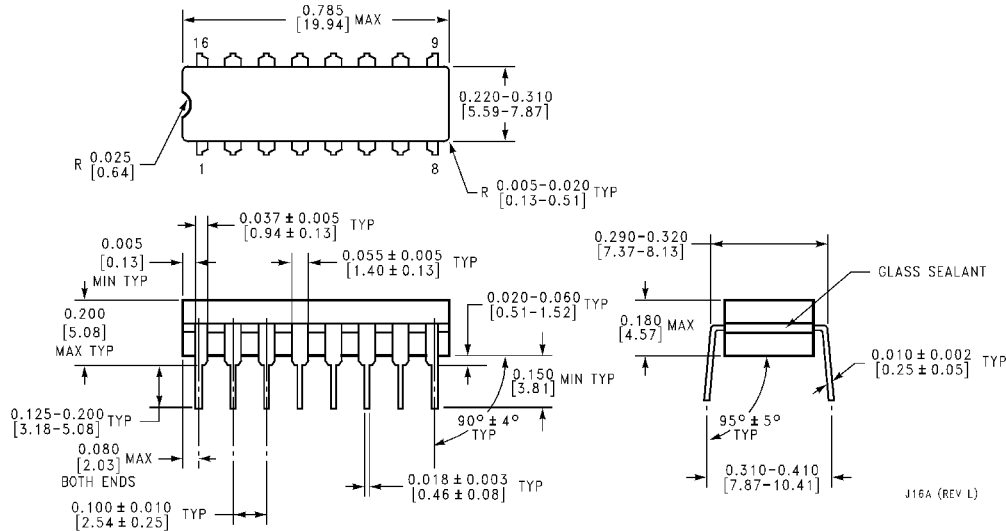

16-Lead Ceramic Dual-In-Line Package (J)
Order Number 9334DMQB or DM9334J
Package Number J16A

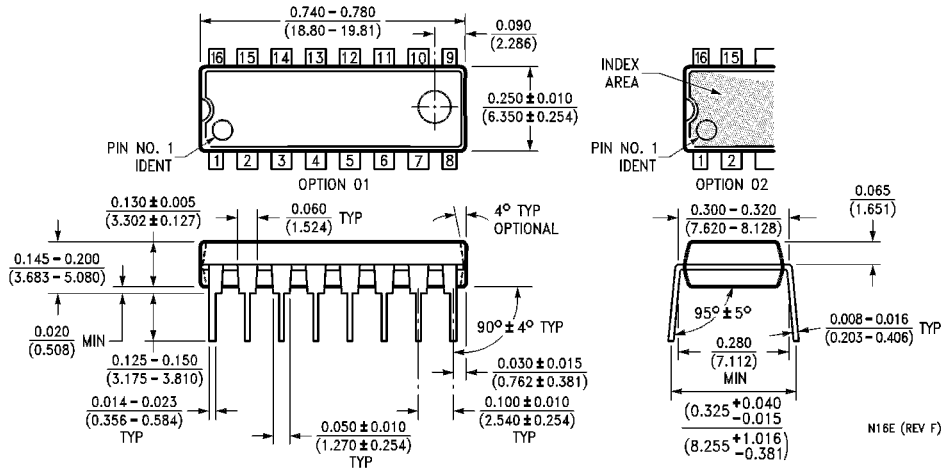

16-Lead Molded Dual-In-Line Package (N)
Order Number DM9334N
Package Number N16E

Physical Dimensions inches (millimeters) unless otherwise noted (Continued)

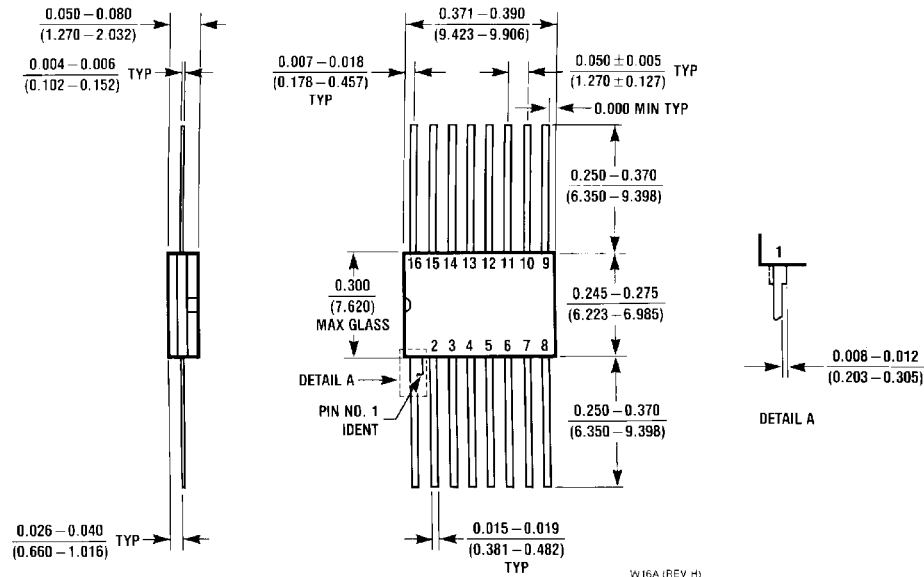

16-Lead Ceramic Flat Package (W)
Order Number 9334FMQB
Package Number W16A

LIFE SUPPORT POLICY

FAIRCHILD'S PRODUCTS ARE NOT AUTHORIZED FOR USE AS CRITICAL COMPONENTS IN LIFE SUPPORT DEVICES OR SYSTEMS WITHOUT THE EXPRESS WRITTEN APPROVAL OF THE PRESIDENT OF FAIRCHILD SEMICONDUCTOR CORPORATION. As used herein:

1. Life support devices or systems are devices or systems which, (a) are intended for surgical implant into the body, or (b) support or sustain life, and (c) whose failure to perform when properly used in accordance with instructions for use provided in the labeling, can be reasonably expected to result in a significant injury to the user.
2. A critical component in any component of a life support device or system whose failure to perform can be reasonably expected to cause the failure of the life support device or system, or to affect its safety or effectiveness.

Fairchild Semiconductor Corporation
 Americas
 Customer Response Center
 Tel: 1-888-522-5372

Fairchild Semiconductor Europe
 Fax: +49 (0) 1 80-530 85 86
 Email: europe.support@nsc.com
 Deutsch Tel: +49 (0) 8 141-35-0
 English Tel: +44 (0) 1 793-85-68-56
 Italy Tel: +39 (0) 2 57 5631

Fairchild Semiconductor Hong Kong Ltd.
 13th Floor, Straight Block,
 Ocean Centre, 5 Canton Rd.
 Tsimshatsui, Kowloon
 Hong Kong
 Tel: +852 2737-7200
 Fax: +852 2314-0061

National Semiconductor Japan Ltd.
 Tel: 81-3-5620-6175
 Fax: 81-3-5620-6179

www.fairchildsemi.com