

## 150-mA Low-Noise LDO Regulator With Error Flag and Discharge Option

### FEATURES

- Ultra Low Dropout—130 mV at 150-mA Load
- Low Noise—75  $\mu\text{V}_{\text{(rms)}}$  (10-Hz to 100-kHz Bandwidth)
- Out-of-Regulation Error Flag (power good)
- Shutdown Control
- 110- $\mu\text{A}$  Ground Current at 150-mA Load
- Fast Start-Up (50  $\mu\text{s}$ )
- 1.5% Guaranteed Output Voltage Accuracy (1.2 V, 2%)
- 300-mA Peak Output Current Capability
- Uses Low ESR Ceramic Capacitors
- Fast Line and Load Transient Response ( $\leq 30 \mu\text{s}$ )
- 1- $\mu\text{A}$  Maximum Shutdown Current
- Output Current Limit
- Reverse Battery Protection
- Built-in Short Circuit and Thermal Protection



Pb-free  
Available

- Si91842: Output—Auto-Discharge In Shutdown Mode
- Si91844: Output—No-Discharge In Shutdown Mode
- Fixed 1.2, 1.8, 2.0, 2.2, 2.5, 2.6, 2.7, 2.8, 2.85, 2.9, 3.0, 3.3, 3.5, 3.6, 5.0-V Output Voltage Options
- Thin SOT23-5 Package

### APPLICATIONS

- Cellular Phones, Wireless Handsets
- Noise-Sensitive Electronic Systems, Laptop and Palmtop Computers
- PDAs
- Pagers
- Digital Cameras
- MP3 Player
- Wireless Modem

### DESCRIPTION

The Si91842/4 is a 150-mA CMOS LDO (low dropout) voltage regulator. It is the perfect choice for low voltage, low power applications. An ultra low ground current and ultra fast turn-on make this part attractive for battery operated power systems. The Si91842/4 also offers ultra low dropout voltage to prolong battery life in portable electronics. Systems requiring a quiet voltage source will benefit from the Si91842/4's low output noise. The Si91842/4 is designed to maintain regulation while delivering 300-mA peak current, making it ideal for systems that have a high surge current upon turn-on.

pull-down circuit is built into the Si91842/4 to clamp the output voltage when it rises beyond normal regulation. The Si91842 automatically discharges the output voltage by connecting the output to ground through a 100- $\Omega$  n-channel MOSFET when the device is put in shutdown mode.

The Si91842/4 features reverse battery protection to limit reverse current flow to approximately 1- $\mu\text{A}$  in the event reversed battery is applied at the input, thus preventing damage to the IC.

For better transient response and regulation, an active

The Si91842/4 is available in both standard and lead (Pb)-free packages.

### TYPICAL APPLICATION CIRCUIT

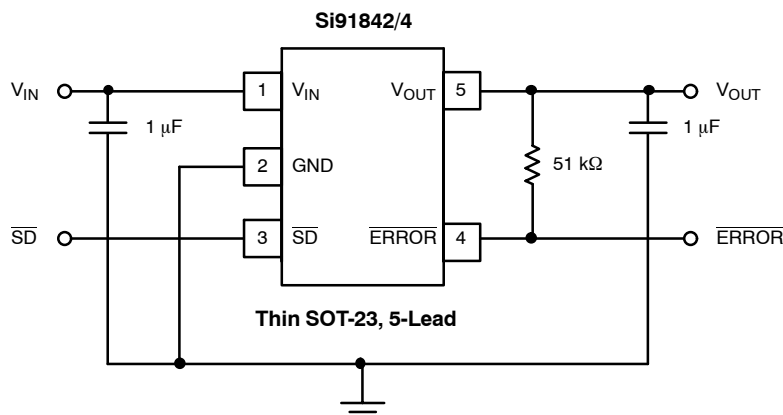



## ABSOLUTE MAXIMUM RATINGS

### Absolute Maximum Ratings

|   |                            |
|---|----------------------------|
| Input Voltage, $V_{IN}$ to GND                    | -6.0 to 6.5 V              |
| $V_{ERROR}$ , $V_{SD}$ (See Detailed Description) | -0.3 V to $V_{IN}$         |
| Output Current, $I_{OUT}$                         | Short Circuit Protected    |
| Output Voltage, $V_{OUT}$                         | -0.3 V to $V_{IN} + 0.3$ V |
| Package Power Dissipation, $(P_d)^b$              | 440 mW                     |

|   |                |
|---|----------------|
| Package Thermal Resistance, $(\theta_{JA})^a$ | 180°C/W        |
| Maximum Junction Temperature, $T_{J(max)}$    | 150°C          |
| Storage Temperature, $T_{STG}$                | -65°C to 150°C |

### Notes

- Device mounted with all leads soldered or welded to PC board.
- Derate 5.5 mW/°C above  $T_A = 70^\circ\text{C}$

Stresses beyond those listed under "Absolute Maximum Ratings" may cause permanent damage to the device. These are stress ratings only, and functional operation of the device at these or any other conditions beyond those indicated in the operational sections of the specifications is not implied. Exposure to absolute maximum rating conditions for extended periods may affect device reliability.

## RECOMMENDED OPERATING RANGE

|                         |                 |
|-------------------------|-----------------|
| Input Voltage, $V_{IN}$ | 2 V to 6 V      |
| Input Voltage, $V_{SD}$ | 0 V to $V_{IN}$ |

|                                      |               |
|--------------------------------------|---------------|
| Operating Ambient Temperature, $T_A$ | -40°C to 85°C |
|--------------------------------------|---------------|

$C_{IN} = C_{OUT} = 1 \mu\text{F}$  (ceramic)  
Maximum ESR of  $C_{OUT}$ : 0.4  $\Omega$

| SPECIFICATIONS  |   |  |                              |                   |                       |                  |                    |      |
|---|---|--|------------------------------|-------------------|-----------------------|------------------|--------------------|------|
| Parameter   | Symbol  | Test Conditions Unless Specified<br>$T_A = 25^\circ\text{C}$ , $V_{IN} = V_{OUT(nom)} + 1$ V, $I_{OUT} = 1$ mA,<br>$C_{IN} = 1 \mu\text{F}$ , $C_{OUT} = 1.0 \mu\text{F}$ , $V_{SD} = 1.5$ V |                              | Temp <sup>a</sup> | Limits<br>-40 to 85°C |                  |                    | Unit |
|   |   |  |                              |                   | Min <sup>b</sup>      | Typ <sup>c</sup> | Max <sup>b</sup>   |      |
| Input Voltage Range   | $V_{IN}$  |  |                              | Full              | 2                     |                  | 6                  | V    |
| Output Voltage Accuracy   |   | $1 \text{ mA} \leq I_{OUT} \leq 150 \text{ mA}$  | $V_{OUT} \geq 1.8 \text{ V}$ | Room              | -1.5                  | 1                | 1.5                | %    |
|   |   |  |                              | Full              | -2.5                  | 1                | 2.5                |      |
|   |   |  |                              | Room              | -2.0                  | 1                | 2.0                |      |
|   |   |  |                              | Full              | -3.0                  | 1                | 3.0                |      |
| Line Regulation ( $V_{OUT} \leq 3$ V)   | $\frac{\Delta V_{OUT} \times 100}{\Delta V_{IN} \times V_{OUT(nom)}}$ | From $V_{IN} = V_{OUT(nom)} + 1$ V to $V_{OUT(nom)} + 2$ V   |                              | Full              | -0.06                 |                  | 0.18               | %V   |
| Line Regulation<br>( $3.0 \text{ V} < V_{OUT} \leq 3.6 \text{ V}$ )             |   |  |                              | Full              | 0                     |                  | 0.3                |      |
| Line Regulation (5-V Version)   |   |  |                              | Full              | 0                     |                  | 0.4                |      |
| Dropout Voltage <sup>d, g</sup><br>( $V_{OUT(nom)} \geq 2.6$ V)                 | $V_{IN} - V_{OUT}$  | $I_{OUT} = 1 \text{ mA}$   | Room                         |                   | 1                     |                  | mV                 |      |
|   |   |  | Room                         |                   | 45                    | 80               |                    |      |
|   |   |  | Full                         |                   | 50                    | 90               |                    |      |
|   |   |  | Room                         |                   | 130                   | 180              |                    |      |
|   |   |  | Full                         |                   | 220                   |                  |                    |      |
|   |   |  | Room                         |                   | 65                    | 100              |                    |      |
| Dropout Voltage <sup>d, g</sup><br>( $V_{OUT(nom)} < 2.6$ V, $V_{IN} \geq 2$ V) | $V_{IN} - V_{OUT}$  | $I_{OUT} = 50 \text{ mA}$  | Room                         |                   |                       | 120              | mV                 |      |
|   |   |  | Full                         |                   |                       | 120              |                    |      |
|   |   |  | Room                         |                   | 190                   | 250              |                    |      |
|   |   |  | Full                         |                   | 300                   |                  |                    |      |
|   |   |  | Room                         |                   | 100                   | 150              |                    |      |
|   |   |  | Full                         |                   | 180                   |                  |                    |      |
| Ground Pin Current <sup>e, g</sup><br>( $V_{OUT(nom)} \leq 3$ V)                | $I_{GND}$   | $I_{OUT} = 0 \text{ mA}$   | Room                         |                   |                       | 200              | $\mu\text{A}$      |      |
|   |   |  | Full                         |                   |                       | 230              |                    |      |
|   |   |  | Room                         |                   | 110                   | 200              |                    |      |
|   |   |  | Full                         |                   | 200                   |                  |                    |      |
|   |   |  | Room                         |                   | 120                   | 200              |                    |      |
|   |   |  | Full                         |                   | 230                   |                  |                    |      |
| Ground Pin Current <sup>e, g</sup><br>( $V_{OUT(nom)} > 3$ V)                   | $I_{GND}$   | $I_{OUT} = 0 \text{ mA}$   | Room                         |                   |                       | 200              | $\mu\text{A}$      |      |
|   |   |  | Full                         |                   |                       | 200              |                    |      |
|   |   |  | Room                         |                   | 120                   | 200              |                    |      |
|   |   |  | Full                         |                   | 230                   |                  |                    |      |
|   |   |  | Room                         |                   | 120                   | 200              |                    |      |
|   |   |  | Full                         |                   | 230                   |                  |                    |      |
| Peak Output current   | $I_{O(peak)}$   | $V_{OUT} \geq 0.95 \times V_{OUT(nom)}$ , $t_{PW} = 2$ ms  |                              | Full              | 300                   |                  | mA                 |      |
| Output Noise Voltage  | $e_N$   | $V_{OUT} = 2.6$ V, BW = 10 Hz to 100 kHz,<br>0 mA < $I_{OUT}$ < 150 mA   |                              | Room              |                       | 75               | $\mu\text{V(rms)}$ |      |



| <b>SPECIFICATIONS</b>                 |                                |   |                      |                   |                  |                  |                  |      |
|---------------------------------------|--------------------------------|---|----------------------|-------------------|------------------|------------------|------------------|------|
| Parameter                             | Symbol                         | Test Conditions Unless Specified  |                      |                   | Limits           |                  |                  | Unit |
|                                       |                                | $T_A = 25^\circ\text{C}$ , $V_{IN} = V_{OUT(nom)} + 1\text{ V}$ , $I_{OUT} = 1\text{ mA}$ ,<br>$C_{IN} = 1\ \mu\text{F}$ , $C_{OUT} = 1.0\ \mu\text{F}$ , $V_{SD} = 1.5\text{ V}$ |                      |                   | -40 to 85°C      |                  |                  |      |
|                                       |                                |   |                      | Temp <sup>a</sup> | Min <sup>b</sup> | Typ <sup>c</sup> | Max <sup>b</sup> |      |
| Ripple Rejection                      | $\Delta V_{OUT}/\Delta V_{IN}$ | $I_{OUT} = 150\text{ mA}$   | $f = 1\text{ kHz}$   | Room              |                  | 60               |                  | dB   |
|                                       |                                |   | $f = 10\text{ kHz}$  | Room              |                  | 40               |                  |      |
|                                       |                                |   | $f = 100\text{ kHz}$ | Room              |                  | 30               |                  |      |
| Dynamic Line Regulation               | $\Delta V_{O(line)}$           | $V_{IN} : V_{OUT(nom)} + 1\text{ V to } V_{OUT(nom)} + 2\text{ V}$<br>$t_r/t_f = 2\ \mu\text{s}$ , $I_{OUT} = 150\text{ mA}$  |                      | Room              |                  | 20               |                  | mV   |
| Dynamic Load Regulation               | $\Delta V_{O(load)}$           | $I_{OUT} : 1\text{ mA to } 150\text{ mA}$ , $t_r/t_f = 2\ \mu\text{s}$  |                      | Room              |                  | 25               |                  |      |
| Thermal Shutdown Junction Temperature | $T_{J(S/D)}$                   |   |                      | Room              |                  | 150              |                  | °C   |
| Thermal Hysteresis                    | $T_{HYST}$                     |   |                      | Room              |                  | 20               |                  |      |
| Reverse current                       | $I_R$                          | $V_{IN} = -6.0\text{ V}$  |                      | Room              |                  | 1                |                  | μA   |
| Short Circuit Current                 | $I_{SC}$                       | $V_{OUT} = 0\text{ V}$  |                      | Room              |                  | 700              |                  | mA   |
| <b>Shutdown</b>                       |                                |   |                      |                   |                  |                  |                  |      |
| Shutdown Supply Current               | $I_{CC(off)}$                  | $V_{SD} = 0\text{ V}$   |                      | Room              |                  | 0.1              | 1                | μA   |
| SD Pin Input Voltage                  | $V_{SD}$                       | High = Regulator ON (Rising)  |                      | Full              | 1.5              |                  | $V_{IN}$         | V    |
|                                       |                                | Low = Regulator OFF (Falling)   |                      | Full              |                  |                  | 0.4              |      |
| Auto Discharge Resistance             | $R_{DIS}$                      | Si91842 Only  |                      | Room              |                  | 100              |                  | Ω    |
| SD Pin Input Current <sup>f</sup>     | $I_{IN(SD)}$                   | $V_{SD} = 1.5\text{ V}$ , $V_{IN} = 6\text{ V}$   |                      | Room              |                  | 0.7              |                  | μA   |
| SD Hysteresis                         | $V_{HYST(SD)}$                 |   |                      | Full              |                  | 150              |                  | mV   |
| $V_{OUT}$ Turn-On Time                | $t_{ON}$                       | $V_{SD}$ (See Figure 1), $I_{LOAD} = 100\text{ mA}$   |                      | Room              |                  | 50               |                  | μS   |
| <b>ERROR Output</b>                   |                                |   |                      |                   |                  |                  |                  |      |
| ERROR High Leakage                    | $I_{OFF}$                      | ERROR ≤ $V_{IN}$ , $V_{OUT}$ in Regulation  |                      | Full              |                  |                  | 1                | μA   |
| ERROR Low Voltage                     | $V_{OL}$                       | $I_{SINK} = 0.5\text{ mA}$  |                      | Full              |                  |                  | 0.4              | V    |
| ERROR Voltage Threshold               | $V_{ERROR}$                    | $V_{OUT}$ Below $V_{OUT(nom)}^g$ , $V_{IN} \geq 2\text{ V}$<br>$V_{OUT}$ Falling, $I_{OUT} = 1\text{ mA}$ , $V_{OUT(nom)} \geq 2\text{ V}$  |                      | Full              | -2               | -4               | -6               | %    |
|                                       |                                | $V_{OUT(nom)}^g < 2\text{ V}$ , $V_{IN} > 2\text{ V}$   |                      | Full              |                  | -4               |                  |      |
| ERROR Voltage Threshold Hysteresis    | $V_{HYST(ERROR)}$              |   |                      | Room              |                  | 1.5              |                  |      |

**Notes**

- a. Room = 25°C, Full = -40 to 85°C.
- b. The algebraic convention whereby the most negative value is a minimum and the most positive a maximum.
- c. Typical values are for DESIGN AID ONLY, not guaranteed nor subject to production testing.
- d. Dropout voltage is defined as the input to output differential voltage at which the output voltage drops 2% below the output voltage measured with a 1-V differential, provided that  $V_{IN}$  does not drop below 2.0 V.
- e. Ground current is specified for normal operation as well as “drop-out” operation.
- f. The device’s shutdown pin includes a typical 2-MΩ internal pull-down resistor connected to ground.
- g.  $V_{OUT(nom)}$  is  $V_{OUT}$  when measured with a 1-V differential to  $V_{IN}$ .

**TIMING WAVEFORMS**

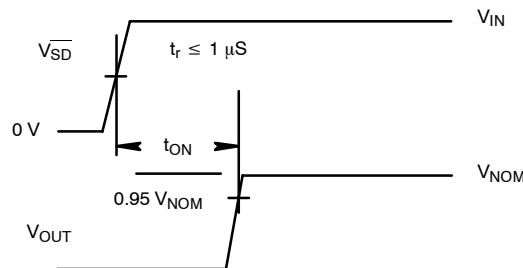

**FIGURE 1.** Timing Diagram for Power-Up

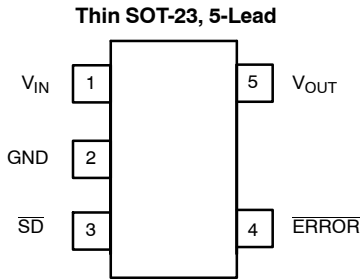
**PIN CONFIGURATION**

**PIN DESCRIPTION**

| Pin No. | Name             | Function   |
|---------|------------------|--|
| 1       | V <sub>IN</sub>  | Input supply pin. Bypass this pin with a 1- $\mu$ F ceramic or tantalum capacitor to ground                            |
| 2       | GND              | Ground pin. For better thermal capability, directly connected to large ground plane                                    |
| 3       | SD               | By applying less than 0.4 V to this pin, the device will be turned off. Connect this pin to V <sub>IN</sub> if unused  |
| 4       | ERROR            | The open drain output is an error flag output which goes low when V <sub>OUT</sub> drops 4% below its nominal voltage. |
| 5       | V <sub>OUT</sub> | Output voltage. Connect C <sub>OUT</sub> between this pin and ground.  |

**ORDERING INFORMATION—Si91842**

| Part Number      | Lead (Pb)-Free Part Number | Marking | Voltage | Temperature Range | Package     |
|------------------|----------------------------|---------|---------|-------------------|-------------|
| Si91842DT-12-T1  | Si91842DT-12-T1—E3         | J8LLL   | 1.2     | -40 to 85°C       | ThinSOT23-5 |
| Si91842DT-18-T1  | Si91842DT-18-T1—E3         | C8LLL   | 1.8     |                   |             |
| Si91842DT-20-T1  | Si91842DT-20-T1—E3         | C9LLL   | 2.0     |                   |             |
| Si91842DT-22-T1  | Si91842DT-22-T1—E3         | C0LLL   | 2.2     |                   |             |
| Si91842DT-25-T1  | Si91842DT-25-T1—E3         | D1LLL   | 2.5     |                   |             |
| Si91842DT-26-T1  | Si91842DT-26-T1—E3         | D2LLL   | 2.6     |                   |             |
| Si91842DT-27-T1  | Si91842DT-27-T1—E3         | D3LLL   | 2.7     |                   |             |
| Si91842DT-28-T1  | Si91842DT-28-T1—E3         | D4LLL   | 2.8     |                   |             |
| Si91842DT-285-T1 | Si91842DT-285—E3           | D5LLL   | 2.85    |                   |             |
| Si91842DT-29-T1  | Si91842DT-29-T1—E3         | D6LLL   | 2.9     |                   |             |
| Si91842DT-30-T1  | Si91842DT-30-T1—E3         | D7LLL   | 3.0     |                   |             |
| Si91842DT-33-T1  | Si91842DT-33-T1—E3         | D8LLL   | 3.3     |                   |             |
| Si91842DT-35-T1  | Si91842DT-35-T1—E3         | D9LLL   | 3.5     |                   |             |
| Si91842DT-36-T1  | Si91842DT-36-T1—E3         | D0LLL   | 3.6     |                   |             |
| Si91842DT-50-T1  | Si91842DT-50-T1—E3         | E1LLL   | 5.0     |                   |             |

LLL = Lot Code

**ORDERING INFORMATION—Si91844**

| Part Number      | Lead (Pb)-Free Part Number | Marking | Voltage | Temperature Range | Package     |
|------------------|----------------------------|---------|---------|-------------------|-------------|
| Si91844DT-18-T1  | Si91844DT-18-T1—E3         | F6LLL   | 1.8     | -40 to 85°C       | ThinSOT23-5 |
| Si91844DT-20-T1  | Si91844DT-20-T1—E3         | F7LLL   | 2.0     |                   |             |
| Si91844DT-22-T1  | Si91844DT-22-T1—E3         | F8LLL   | 2.2     |                   |             |
| Si91844DT-25-T1  | Si91844DT-25-T1—E3         | F9LLL   | 2.5     |                   |             |
| Si91844DT-26-T1  | Si91844DT-26-T1—E3         | F0LLL   | 2.6     |                   |             |
| Si91844DT-27-T1  | Si91844DT-27-T1—E3         | G1LLL   | 2.7     |                   |             |
| Si91844DT-28-T1  | Si91844DT-28-T1—E3         | G2LLL   | 2.8     |                   |             |
| Si91844DT-285-T1 | Si91844DT-285—E3           | G3LLL   | 2.85    |                   |             |
| Si91844DT-29-T1  | Si91844DT-29-T1—E3         | G4LLL   | 2.9     |                   |             |
| Si91844DT-30-T1  | Si91844DT-30-T1—E3         | G5LLL   | 3.0     |                   |             |
| Si91844DT-33-T1  | Si91844DT-33-T1—E3         | G6LLL   | 3.3     |                   |             |
| Si91844DT-35-T1  | Si91844DT-35-T1—E3         | G7LLL   | 3.5     |                   |             |
| Si91844DT-36-T1  | Si91844DT-36-T1—E3         | G8LLL   | 3.6     |                   |             |
| Si91844DT-50-T1  | Si91844DT-50-T1—E3         | G9LLL   | 5.0     |                   |             |

LLL = Lot Code

**TYPICAL CHARACTERISTICS (INTERNALLY REGULATED, 25°C UNLESS NOTED)**

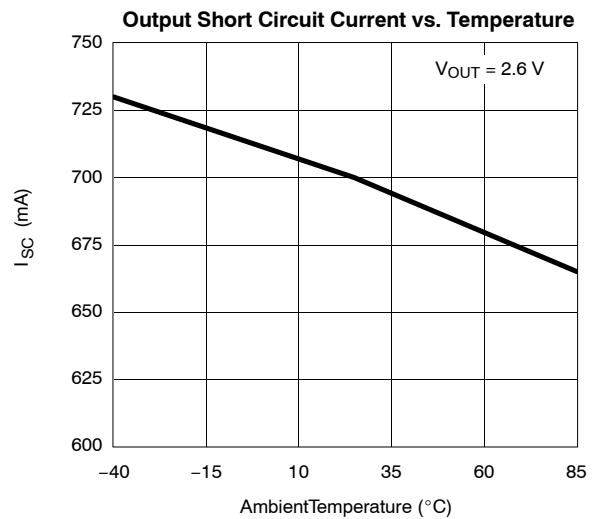
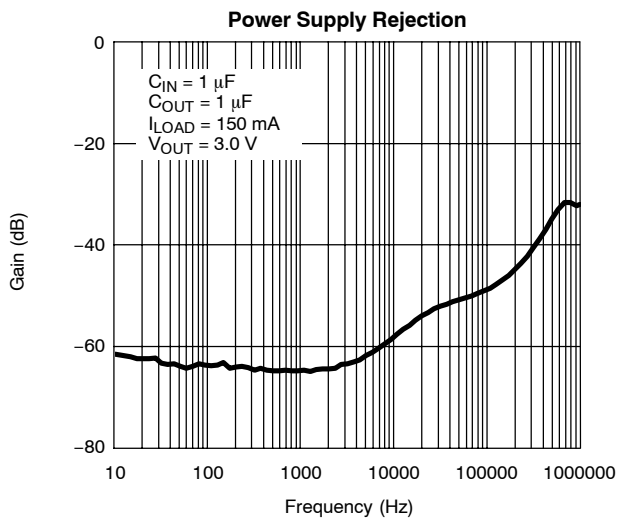
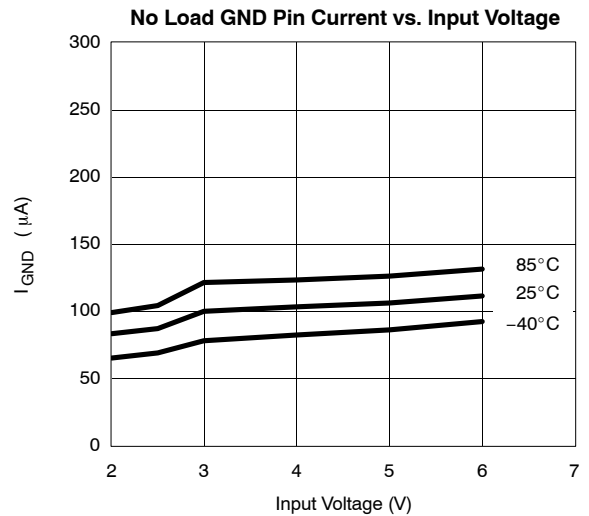
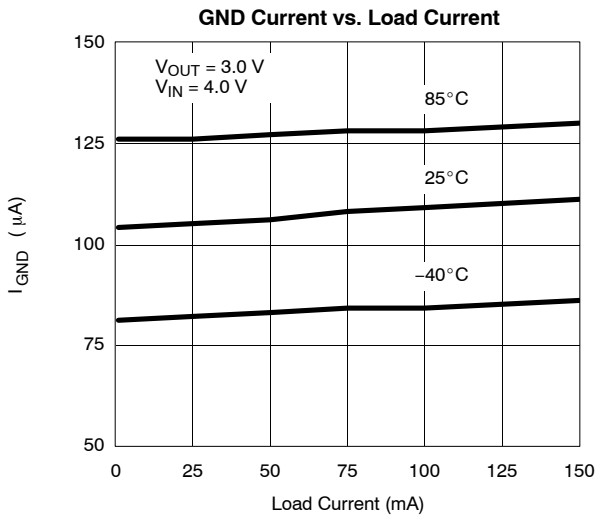
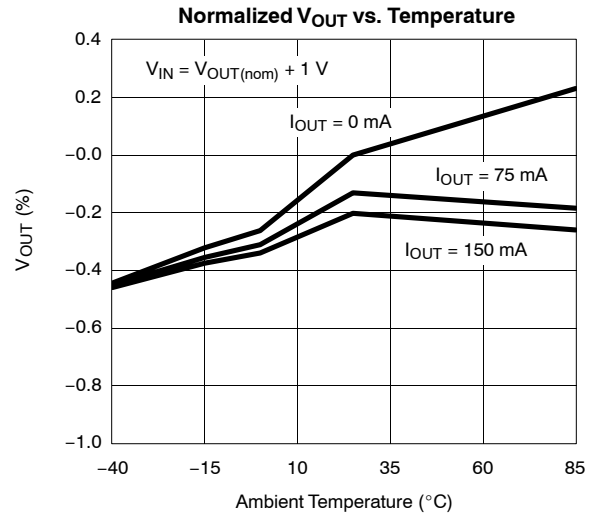
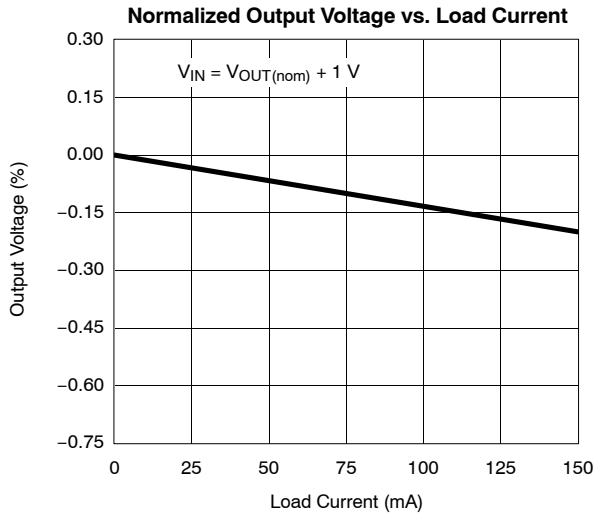

**TYPICAL CHARACTERISTICS (INTERNALLY REGULATED, 25°C UNLESS NOTED)**

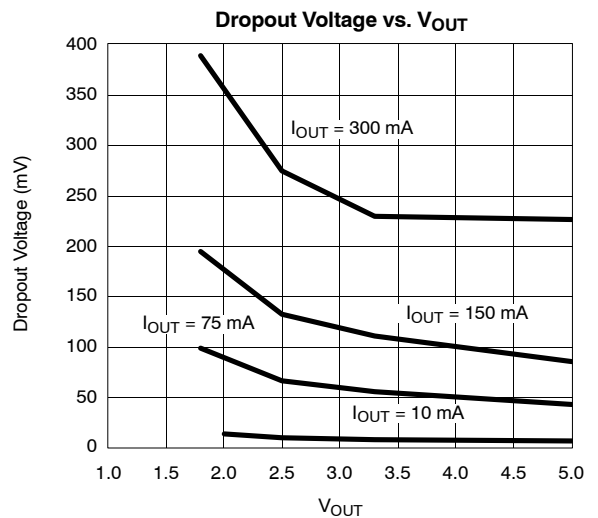
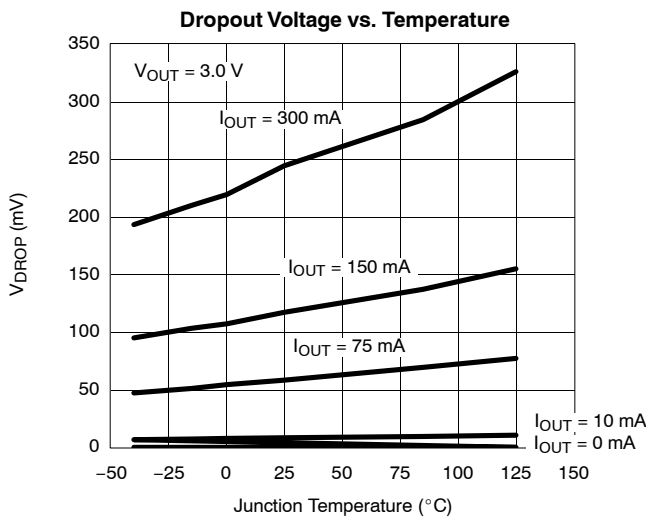
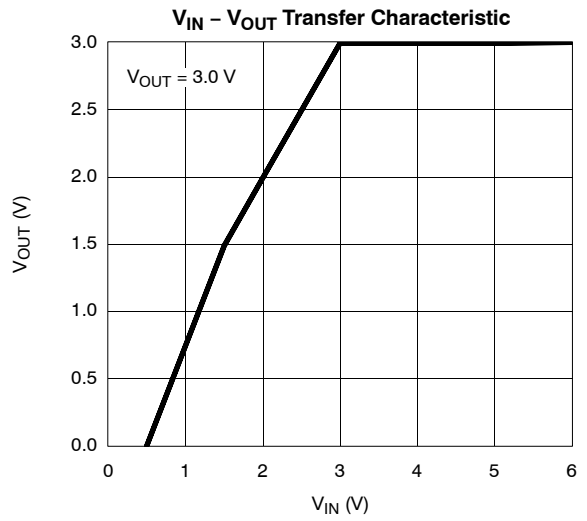
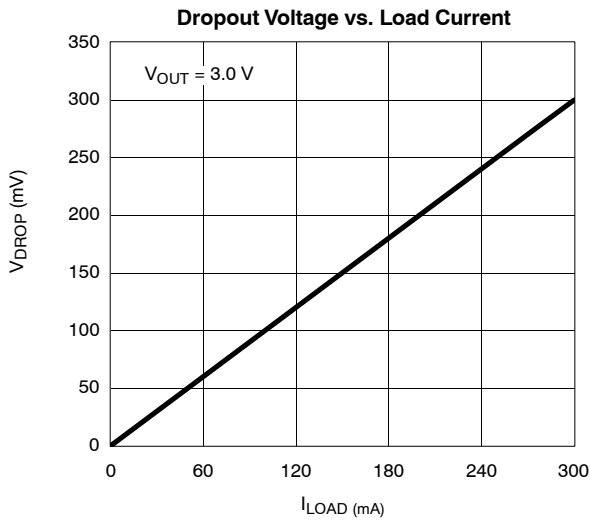

**TYPICAL WAVEFORMS**

**Load Transient Response-1**

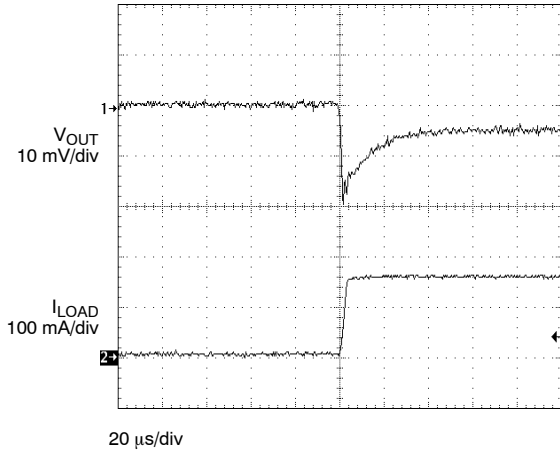

$V_{OUT} = 3.0\text{ V}$   
 $C_{OUT} = 1\ \mu\text{F}$   
 $I_{LOAD} = 1\ \text{to}\ 150\ \text{mA}$   
 $t_{rise} = 2\ \mu\text{sec}$

**Load Transient Response-2**

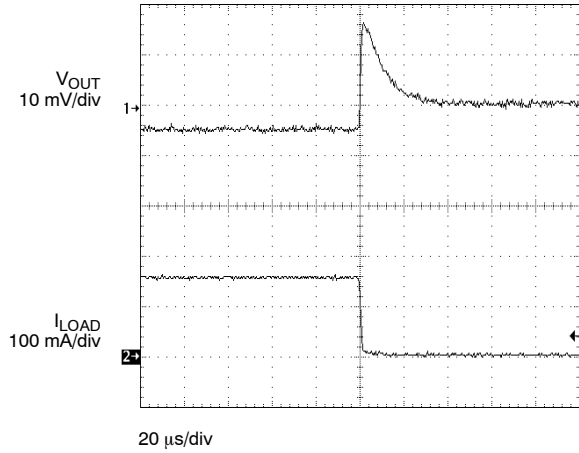

$V_{OUT} = 3.0\text{ V}$   
 $C_{OUT} = 1\ \mu\text{F}$   
 $I_{LOAD} = 150\ \text{to}\ 1\ \text{mA}$   
 $t_{fall} = 2\ \mu\text{sec}$

**Line Transient Response-1**

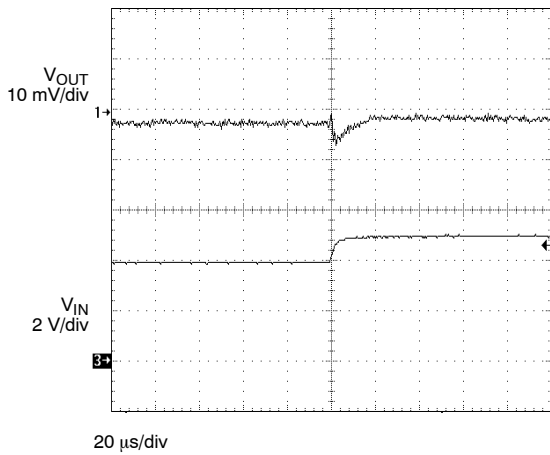

$V_{INSTEP} = 4\ \text{to}\ 5\ \text{V}$   
 $V_{OUT} = 3\ \text{V}$   
 $C_{OUT} = 1\ \mu\text{F}$   
 $C_{IN} = 1\ \mu\text{F}$   
 $I_{LOAD} = 150\ \text{mA}$   
 $t_{rise} = 5\ \mu\text{sec}$

**Line Transient Response-2**

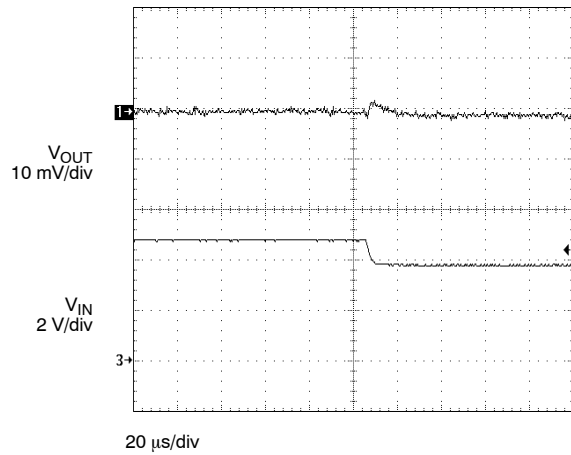

$V_{INSTEP} = 5\ \text{to}\ 4\ \text{V}$   
 $V_{OUT} = 3\ \text{V}$   
 $C_{OUT} = 1\ \mu\text{F}$   
 $C_{IN} = 1\ \mu\text{F}$   
 $I_{LOAD} = 150\ \text{mA}$   
 $t_{fall} = 5\ \mu\text{sec}$

**TYPICAL WAVEFORMS**

**Output Noise**

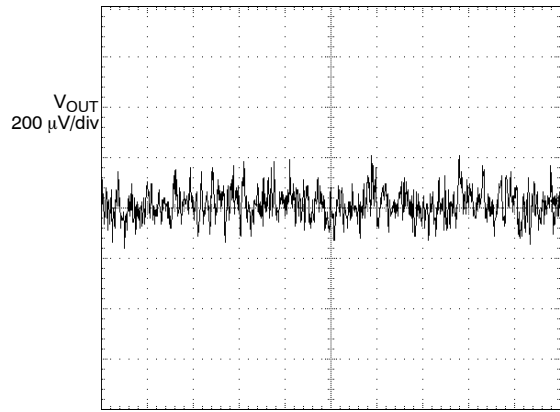

4 ms/div

$V_{IN} = 4\text{ V}$   
 $V_{OUT} = 3\text{ V}$   
 $I_{OUT} = 150\text{ mA}$   
BW = 10 Hz to 100 kHz

**Noise Spectrum**

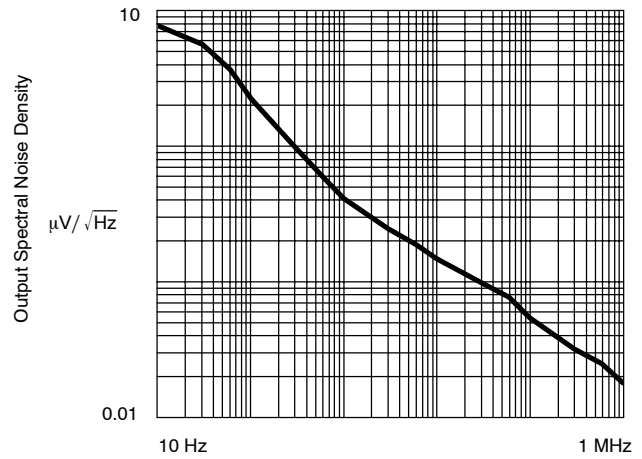

$V_{IN} = 4\text{ V}$   
 $V_{OUT} = 3\text{ V}$   
 $I_{LOAD} = 150\text{ mA}$



**BLOCK DIAGRAM**

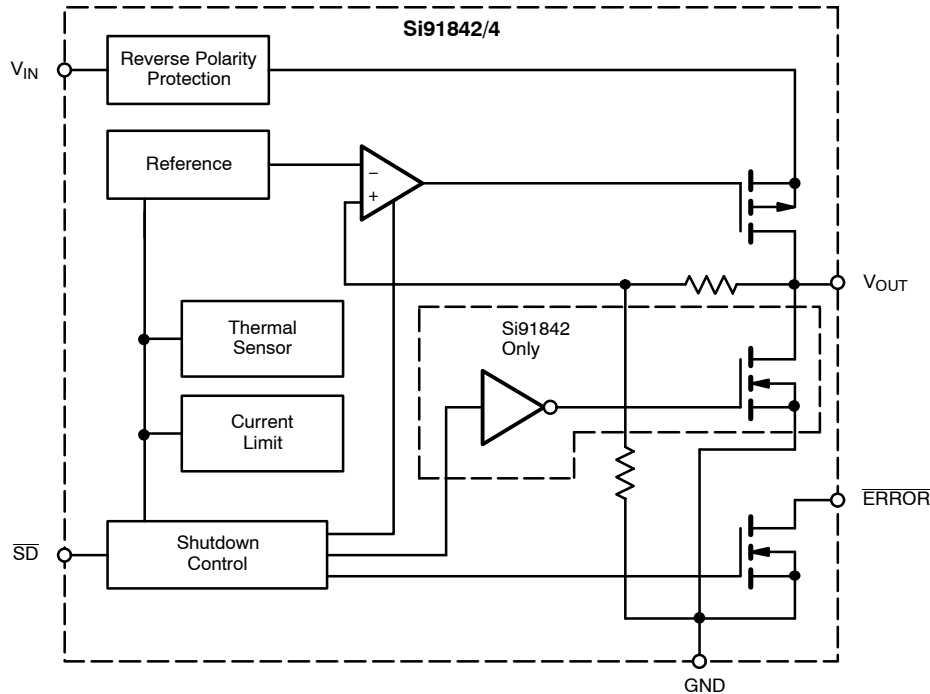

**DETAILED DESCRIPTION**

The Si91842/4 is a low-noise, low drop-out and low quiescent current linear voltage regulator, packaged in a small footprint Thin SOT23-5 package. The Si91842/4 can supply loads up to 300 mA. As shown in the block diagram, the circuit consists of a bandgap reference, error amplifier, p-channel pass transistor and feedback resistor string. Additional blocks, not shown in the block diagram, include a precise current limiter, reverse battery and current protection, and thermal sensor.

**Thermal Overload Protection**

The thermal overload protection limits the total power dissipation and protects the device from being damaged. When the junction temperature exceeds 150°, the device turns the p-channel pass transistor off.

**Reverse Battery Protection**

The Si91842/4 has a battery reverse protection circuitry that disconnects the internal circuitry when  $V_{IN}$  drops below the GND voltage. There is no current drawn in such an event. When the  $\overline{SD}$  pin is hardwired to  $V_{IN}$ , the user must connect the  $\overline{SD}$  pin to  $V_{IN}$  via a 100-k $\Omega$  resistor if reverse battery

protection is desired. Hardwiring the  $\overline{SD}$  pin directly to the  $V_{IN}$  pin is allowed when reverse battery protection is not desired.

**ERROR**

$\overline{ERROR}$  is an open drain output that goes low when  $V_{OUT}$  is less than 4% of its normal value. To obtain a logic level output, connect a pull-up resistor from  $\overline{ERROR}$  to  $V_{OUT}$  or any other voltage equal to or less than  $V_{IN}$ .  $\overline{ERROR}$  pin is high impedance (off) when  $\overline{SD}$  pin is low.

**Auto-Discharge/No-Discharge**

$V_{OUT}$  has an internal 100- $\Omega$  (typ.) discharge path to ground when  $\overline{SD}$  pin is low for the Si91842. The Si91844 does not have a discharge path when the  $\overline{SD}$  pin is low.

**Stability**

The circuit is stable with only a small output capacitor equal to 6 nF/mA (= 1  $\mu$ F @ 150 mA). Since the bandwidth of the error amplifier is around 1–3 MHz and the dominant pole is at the output node, the capacitor should be capacitive in this range, i.e., for 150-mA load current, an ESR <0.4  $\Omega$  is necessary. Parasitic inductance of about 10 nH can be tolerated.

*Vishay Siliconix maintains worldwide manufacturing capability. Products may be manufactured at one of several qualified locations. Reliability data for Silicon Technology and Package Reliability represent a composite of all qualified locations. For related documents such as package/tape drawings, part marking, and reliability data, see <http://www.vishay.com/ppg?71732>.*