

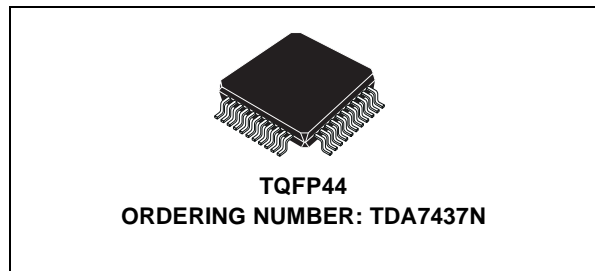

## DIGITALLY CONTROLLED AUDIO PROCESSOR

- INPUT MULTIPLEXER
  - FOUR STEREO, ONE MONO INPUT, AND ONE DIFFERENTIAL INPUT
  - SELECTABLE INPUT GAIN FOR OPTIMAL ADAPTATION TO DIFFERENT SOURCES
- FULLY PROGRAMMABLE LOUDNESS FUNCTION
- VOLUME CONTROL IN 1dB STEPS INCLUDING GAIN UP TO 16dB
- ZERO CROSSING MUTE, SOFT MUTE AND DIRECT MUTE
- BASS AND TREBLE CONTROL
- FOUR SPEAKER ATTENUATORS- FOUR INDEPENDENT SPEAKERS CONTROL IN 1dB STEPS FOR BALANCE AND FADER FACILITIES
- PAUSE DETECTOR PROGRAMMABLE THRESHOLD
- ALL FUNCTIONS PROGRAMMABLE VIA SERIAL I<sup>2</sup>C BUS



### DESCRIPTION

The audioprocessor TDA7437N is an upgrade of the TDA731X audioprocessor family.

Due to a highly linear signal processing, using CMOS-switching techniques instead of standard bipolar multipliers, very low distortion and very low noise are obtained. Several new features like soft-mute, and zero-crossing mute are implemented. The soft Mute function can be activated in two ways:

- 1 Via serial bus (Mute byte, bit D0)
- 2 Directly on pin 28 through an I/O line of the microcontroller

Very low DC stepping is obtained by use of a BIC-MOS technology.

### PIN DESCRIPTION (Top view)

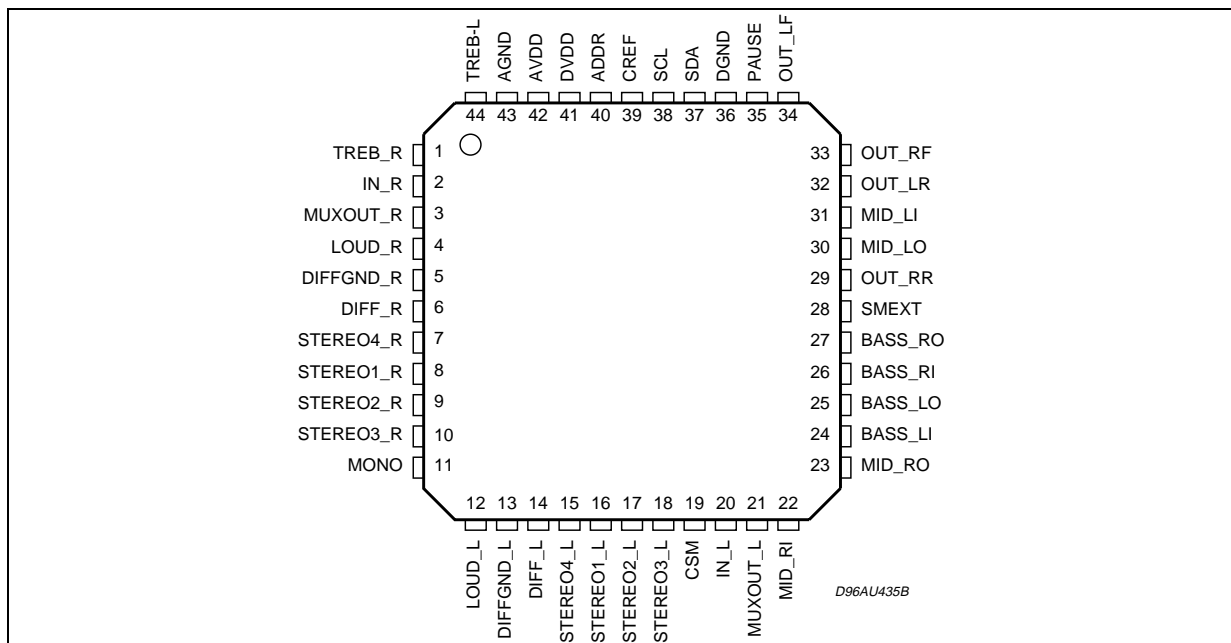

## TDA7437N

### ABSOLUTE MAXIMUM RATINGS

Symbol	Parameter	Value	Unit
AV <sub>DD</sub> , DV <sub>DD</sub>	Operating Supply Voltage	10.5	V
T <sub>amb</sub>	Operating Ambient Temperature	-40 to 85	°C
T <sub>stg</sub>	Storage Temperature Range	-55 to 150	°C

### THERMAL DATA

Symbol	Parameter	Value	Unit
R <sub>th j-amb</sub>	Thermal Resistance Junction to pins Max.	150	°C/W

### QUICK REFERENCE DATA

Symbol	Parameter	Min.	Typ.	Max.	Unit
AV <sub>DD</sub> , DV <sub>DD</sub>	Supply Voltage (AV <sub>DD</sub> and DV <sub>DD</sub> must be at the same potential)	6	9	10.2	V
V <sub>CL</sub>	Max. input signal handling	2.1	2.6		V <sub>rms</sub>
THD	Total Harmonic Distortion V = 1V <sub>rms</sub> f = 1KHz		0.01	0.8	%
S/N	Signal to Noise Ratio		111		dB
S <sub>C</sub>	Channel Separation f = 1KHz		95		dB
	Input Gain 1dB step	0		15	dB
	Volume Control 1dB step	-63		16	dB
	Treble Control 2dB step	-14		+14	dB
	Bass Control 2dB step	-14		+14	dB
	Middle Control 2dB step	-14		+14	dB
	Fader and Balance Control 1dB step	-79		0	dB
	Loudness Control 1dB step	0		20	dB
	Mute Attenuation		100		dB

BLOCK DIAGRAM

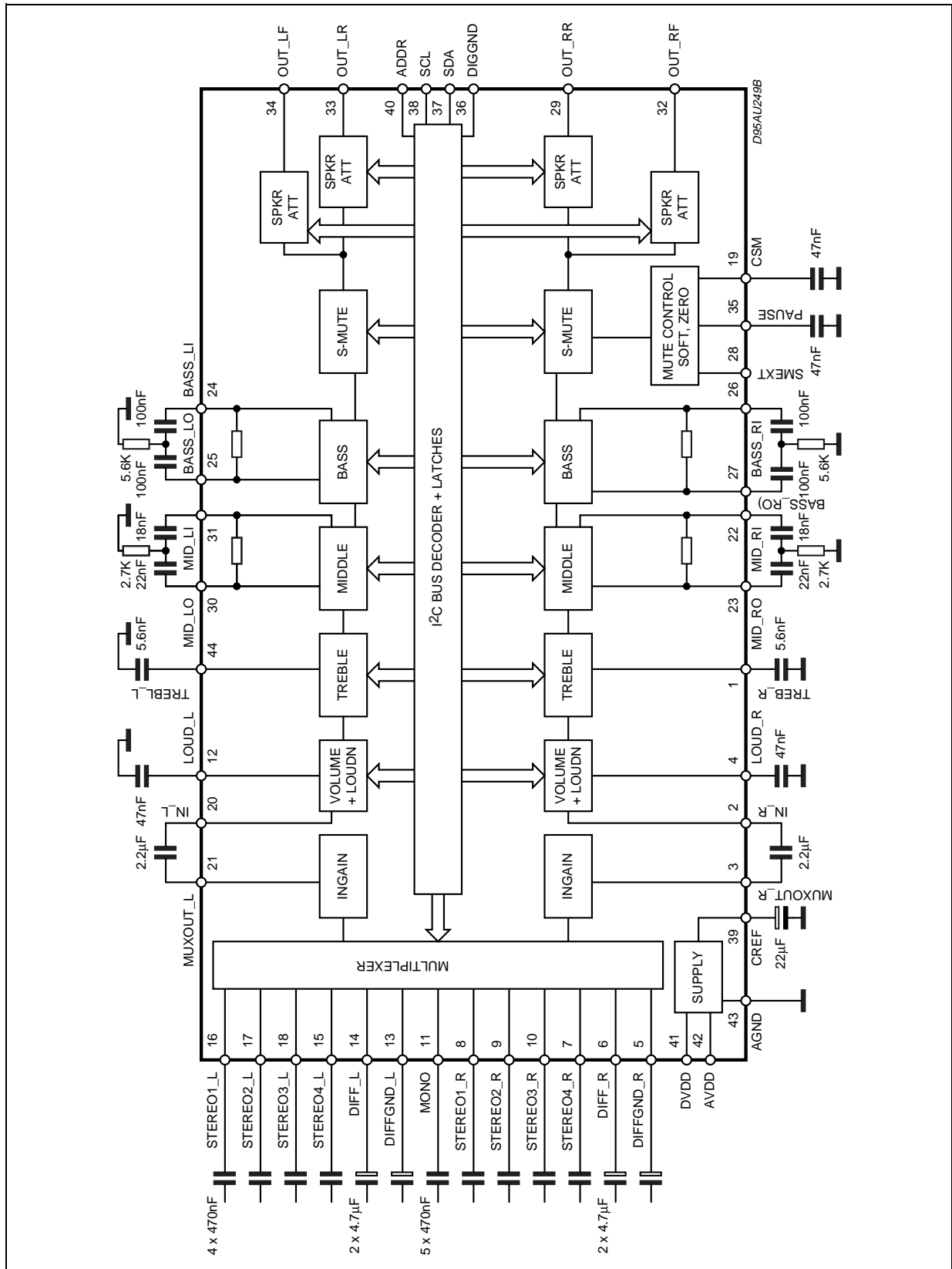

## TDA7437N

### ELECTRICAL CHARACTERISTICS

( $V_{DD}$ ,  $DV_{DD}$  = 9V;  $R_L$  = 10K $\Omega$ ;  $R_g$  = 50 $\Omega$ ;  $T_{amb}$  = 25°C; all gains = 0dB;  $f$  = 1KHz. Refer to the test circuit, unless otherwise specified.)

Symbol	Parameter	Test Condition	Min.	Typ.	Max.	Unit
<b>INPUT SELECTOR (MONO AND STEREO INPUTS)</b>						
$R_I$	Input Resistance	pin 7 to 11 and 15 to 18	70	100	130	K $\Omega$
$V_{CL}$	Clipping Level	$d \leq 0.3\%$	2.1	2.6		V <sub>RMS</sub>
$S_I$	Input Separation		80	95		dB
$R_L$	Output Load Resistance		2			K $\Omega$
$G_{I\ MIN}$	Minimum Input Gain		-0.75	0	+0.75	dB
$G_{I\ MAX}$	Maximum Input Gain		14	15	16	dB
$G_{step}$	Step Resolution		0.5	1.0	1.5	dB
$E_a$	Set Error		-1.0	0	1.0	dB
$V_{DC}$	DC Steps	Adjacent Gain Steps		0.5	10	mV
		$G_{I\ MIN}$ to $G_{I\ MAX}$		3		mV
<b>DIFFERENTIAL INPUT (Pin 5, 6, 13, 14)</b>						
$R_I$	Input Resistance	Input selector BIT D4 = 0 (0dB)	10	15	20	K $\Omega$
		Input selector BIT D4 = 1 (-6dB)	14	20	26	K $\Omega$
CMRR	Common Mode Rejection Ratio	$V_{CM} = 1V_{RMS}$ ; $f = 1KHz$	45	70		dB
$d$	Distortion	$V_I = 1V_{RMS}$		0.01	0.08	%
$e_{IN}$	Input Noise	20Hz to 20KHz; Flat; D6 = 0		5		$\mu$ V
$G_{DIFF}$	Differential Gain	D4 = 0	-1	0	1	dB
		D4 = 1	-7	-6	-5	dB
<b>VOLUME CONTROL</b>						
$R_I$	Input Resistance	Pin 2 and 20	31	44	57	K $\Omega$
$G_{MAX}$	Maximum Gain		15	16	17	dB
$A_{MAX}$	Maximum Attenuation		61	63.75	66.5	dB
$A_{STEP}$	Step Resolution Coarse Atten.		0.5	1.0	1.5	dB
$E_A$	Attenuation Set Error	$G = 16$ to $-20$ dB	-1.0	0	1.0	dB
		$G = -20$ to $-63$ dB	-2.75		2.75	dB
$E_t$	Tracking Error				2	dB
$V_{DC}$	DC Steps	Adjacent Gain Steps	-5		+5	mV
		Adjacent Attenuation Steps	-3		+3	mV
		From 0dB to $A_{MAX}$		0.5	5	mV
<b>LOUDNESS CONTROL (Pin 4, 12)</b>						
$R_I$	Internal Resistor	Loud = On	35	50	65	K $\Omega$
$A_{MAX}$	Maximum Attenuation		19	20	21	dB
$A_{step}$	Step Resolution		0.5	1	1.5	dB
<b>ZERO CROSSING MUTE</b>						
$V_{TH}$	Zero Crossing Threshold(note 1)	WIN = 11		35		mV
		WIN = 10		70		mV
		WIN = 01		140		mV
		WIN = 00		280		mV
$A_{MUTE}$	Mute Attenuation		80	100		dB

**ELECTRICAL CHARACTERISTICS** (continued)

( $V_{DD}$ ,  $DV_{DD}$  = 9V;  $R_L$  = 10K $\Omega$ ;  $R_g$  = 50 $\Omega$ ;  $T_{amb}$  = 25°C; all gains = 0dB;  $f$  = 1KHz. Refer to the test circuit, unless otherwise specified.)

Symbol	Parameter	Test Condition	Min.	Typ.	Max.	Unit
$V_{DC}$	DC Step	0dB to Mute		0.1	3	mV
<b>SOFT MUTE</b>						
$A_{MUTE}$	Mute Attenuation		50	65		dB
$T_{DON}$	ON Delay Time	$C_{CSM} = 22nF$ ; 0 to -20dB; $I = I_{MAX}$	0.8	1.5	2.0	ms
		$C_{CSM} = 22nF$ ; 0 to -20dB; $I = I_{MIN}$	25	45	60	ms
$T_{DOFF}$	OFF Current	$V_{CSM} = 0V$ ; $I = I_{MAX}$	20	40	60	mA
		$V_{CSM} = 0V$ ; $I = I_{MIN}$		2		$\mu A$
$R_{INT}$	Pullup Resistor (pin 28)	(note 2)		100		K $\Omega$
$V_{SMH}$	(pin 28) Level High		3.5			V
$V_{SML}$	(pin 28) Level Low	Soft Mute Active			1	V
<b>BASS CONTROL</b>						
$C_{range}$	Control Range		$\pm 11.5$	$\pm 14$	$\pm 16$	dB
$A_{step}$	Step Resolution		1	2	3	dB
$R_g$	Internal Feedback Resistance		31	44	57	K $\Omega$
<b>MIDDLE CONTROL</b>						
$C_{range}$	Control Range		$\pm 11.5$	$\pm 14$	$\pm 16$	dB
$A_{step}$	Step Resolution		1	2	3	dB
$R_g$	Internal Feedback Resistance		17.5	25	32.5	K $\Omega$
<b>TREBLE CONTROL</b>						
$C_{RANGE}$	Control Range		$\pm 13$	$\pm 14$	$\pm 15$	dB
$A_{step}$	Step Resolution		1	2	3	dB
<b>SPEAKER ATTENUATORS</b>						
$C_{RANGE}$	Control Range			79		dB
$A_{step}$	Step Resolution	$A_V = 0$ to -40dB	0.5	1	1.5	dB
$A_{MUTE}$	Output Mute Attenuation	Data Word = 1111XXXX	80	100		dB
$E_A$	Attenuation Set Error	$A_V = 0$ to -40dB			1.5	dB
$V_{DC}$	DC Steps	Adjacent Attenuation Steps		0.1	3	mV
<b>AUDIO OUTPUT</b>						
$V_{dip}$	Clipping Level	$d = 0.3\%$	2.1	2.6		$V_{rms}$
$R_L$	Output Load Resistance		2			K $\Omega$
$R_O$	Output Impedance		50	90	140	$\Omega$
$V_{DC}$	DC Voltage Level		3.5	3.8	4.1	V
<b>PAUSE DETECTOR</b>						
$V_{TH}$	Pause Threshold	$WIN = 11$		35		mV
		$WIN = 10$		70		mV
		$WIN = 01$		140		mV
		$WIN = 00$		280		mV
$I_{DELAY}$	Pull-Up Current		15	25	35	$\mu A$
$V_{THP}$	Pause Threshold			3.0		V

# TDA7437N

## ELECTRICAL CHARACTERISTICS (continued)

( $V_{DD}$ ,  $DV_{DD}$  = 9V;  $R_L$  = 10K $\Omega$ ;  $R_g$  = 50 $\Omega$ ;  $T_{amb}$  = 25°C; all gains = 0dB; f = 1KHz. Refer to the test circuit, unless otherwise specified.)

Symbol	Parameter	Test Condition	Min.	Typ.	Max.	Unit
<b>GENERAL</b>						
$V_{CC}$	Supply Voltage		6	9	10.2	V
$I_{CC}$	Supply Current		7	10	13	mA
PSRR	Power Supply Rejection Ratio	f = 1KHz	70	90		dB
$e_{NO}$	Output Noise	Output Muted (B = 20 to 20kHz flat)		4		$\mu$ V
		All Gains 0dB(B = 200 to 20kHz flat)		6	15	$\mu$ V
$E_t$	Total Tracking Error	$A_V$ = 0 to -20dB		0	1	dB
		$A_V$ = -20 to -60dB		0	2	dB
S/N	Signal to Noise Ratio	All Gains = 0dB; $V_O$ = 2.1Vrms		111		dB
$S_C$	Channel Separation L - R		80	95		dB
d	Distortion	$V_{IN}$ = 1V all gain = 0dB		0.01	0.08	%
<b>BUS INPUTS</b>						
$V_{IL}$	Input Low Voltage				1	V
$V_{IH}$	Input High Voltage		3			V
$I_{IN}$	Input Current	$V_{IN}$ = 0.4V	-5		5	$\mu$ A
$V_O$	Output Voltage SDA Acknowledge	$I_O$ = 1.6mA		0.1	0.4	V

Note 1: WIN represents the MUTE programming bit pair D6, D5 for the zero crossing window threshold

Note 2: Internall pullup resistor to  $V_s/2$ ; "LOW" = softmute active

Note: The ANGND and DIGGND layout wires must be kept separated. A 50 $\Omega$  resistor is recommended to be put as far as possible from the device.

The CLD - and CDR - can be shortcircuited in applications providing 3 wires CD signal

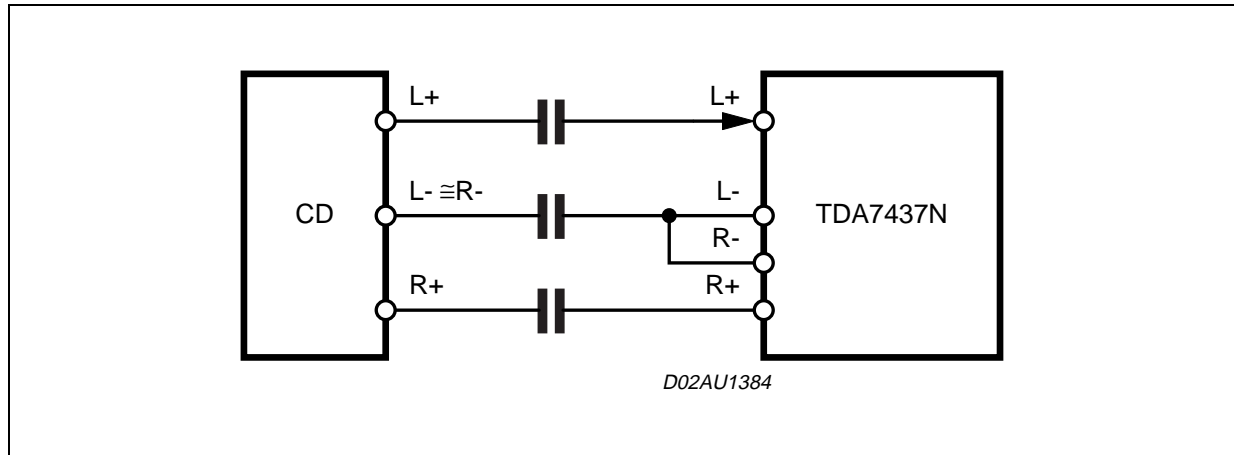

CLD - = DIFFINLGND

CDR - = DIFFINRGND

## I<sup>2</sup>C BUS INTERFACE

Data transmission from microprocessor to the TDA7437N and viceversa takes place thru the 2 wires I<sup>2</sup>C BUS interface, consisting of the two lines SDA and SCL (pull-up resistors to positive supply voltage must be externally connected).

### Data Validity

As shown in fig. 1, the data on the SDA line must be stable during the high period of the clock. The HIGH and LOW state of the data line can only change when the clock signal on the SCL line is LOW.

### Start and Stop Conditions

As shown in fig. 2 a start condition is a HIGH to LOW transition of the SDA line while SCL is HIGH. The stop condition is a LOW to HIGH transition of the SDA line while SCL is HIGH. A STOP conditions must be sent before each START condition.

### Byte Format

Every byte transferred to the SDA line must contain 8 bits. Each byte must be followed by an acknowledge bit. The MSB is transferred first.

### Acknowledge

The master ( $\mu$ P) puts a resistive HIGH level on the SDA line during the acknowledge clock pulse (see fig. 3). The peripheral (audioprocessor) that acknowledges has to pull-down (LOW) the SDA line during the acknowledge clock pulse, so that the SDA line is stable LOW during this clock pulse. The audioprocessor which has been addressed has to generate an acknowledge after the reception of each byte, otherwise the SDA line remains at the HIGH level during the ninth clock pulse time. In this case the master transmitter can generate the STOP information in order to abort the transfer.

### Transmission without Acknowledge

Avoiding to detect the acknowledge of the audioprocessor, the  $\mu$ P can use a simpler transmission: simply it waits one clock without checking the slave acknowledging, and sends the new data. This approach of course is less protected from misworking and decreases the noise immunity.

Figure 1. Data Validity on the I<sup>2</sup>C BUS

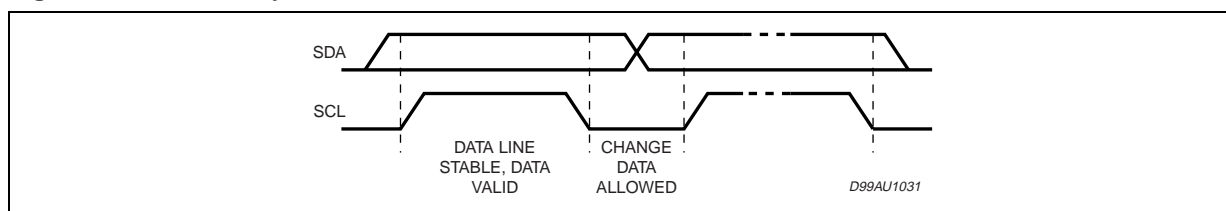

Figure 2. Timing Diagram of I<sup>2</sup>C BUS

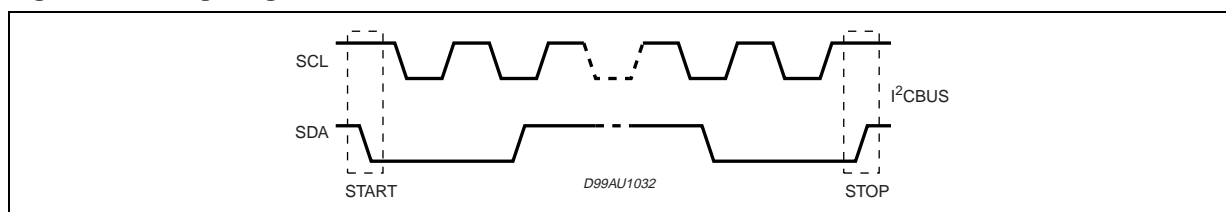
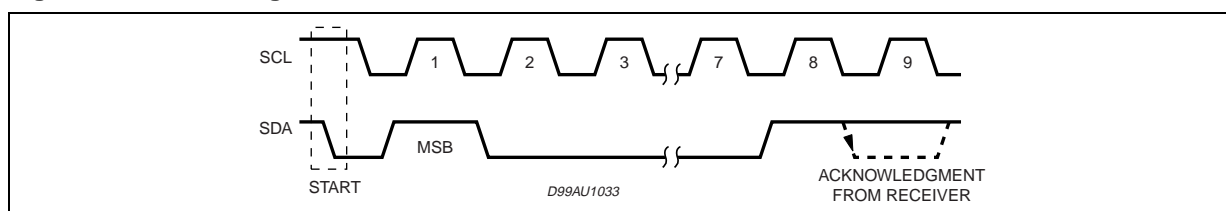

Figure 3. Acknowledge on the I<sup>2</sup>C BUS



**SOFTWARE SPECIFICATION**

**Interface Protocol**

The interface protocol comprises:

- A start condition (s)
- A chip address byte,(the LSB bit determines read (=1)/write (=0) transmission)
- A subaddress byte.
- A sequence of data (N-bytes + acknowledge)
- A stop condition (P)

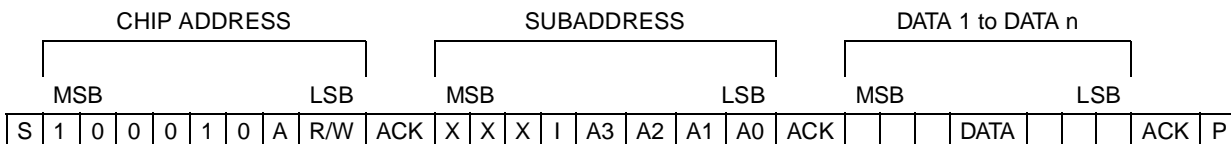

ACK = Acknowledge; S = Start; P = Stop; I = Auto Increment; X = Not used

MAX CLOCK SPEED 500kbits/s

ADDRpin open           A = 0

ADDRpin close to Vs   A = 1

**AUTO INCREMENT**

If bit I in the subaddress byte is set to "1", the autoincrement of the subaddress is enabled

**SUBADDRESS** (receive mode)

MSB				LSB				FUNCTION
X	X	X	I	A3	A2	A1	A0	
				0	0	0	0	Input Selector
				0	0	0	1	Loudness
				0	0	1	0	Volume
				0	0	1	1	Bass, Treble
				0	1	0	0	Speaker Attenuator LF
				0	1	0	1	Speaker Attenuator LR
				0	1	1	0	Speaker Attenuator RF
				0	1	1	1	Speaker Attenuator RR
				1	0	0	0	Input Gain Middle
				1	0	0	1	Mute

**TRANSMITTED DATA**

Send Mode

MSB						LSB	
X	X	X	X	X	SM	ZM	P̄

P̄ = Pause (Active low)

ZM = Zero crossing muted (HIGH active)

SM = Soft mute activated (HIGH active)

X = Not used

The transmitted data is automatically updated after each ACK.

Transmission can be repeated without new chipaddress.



## DATA BYTE SPECIFICATION

MSB							LSB	FUNCTION
D7	D6	D5	D4	D3	D2	D1	D0	
				1	0	0	0	DIFFERENTIAL
				1	0	0	1	STEREO 1
				1	0	1	0	STEREO 2
				1	0	1	1	STEREO 3
				1	1	0	0	STEREO 4
				1	1	0	1	MONO
X	X	X	X	0	X	X	X	DC CONNECT (1)
		0	0					HALF-DIFF 0dB (*)
		0	1					HALF-DIFF -6dB (*)
		1	0					FULL-DIFF 0dB (**)
		1	1					FULL-DIFF -6dB (**)

(\*) Selected when using a 3 wires differential source (pins 5 and 13 shorted)

(\*\*) Selected when using 4 wires differential source

(1) OUTR-INR (OUTL-INR) short circuited internally (no need external connection)

## Loudness

MSB							LSB	FUNCTION
D7	D6	D5	D4	D3	D2	D1	D0	LOUDNESS STEP
		0	0	0	0	0	0	0dB
		0	0	0	0	0	1	1dB
		0	0	0	0	1	0	2dB
		0	0	0	0	1	1	3dB
		0	0	0	1	0	0	4dB
		0	0	0	1	0	1	5dB
		0	0	0	1	1	0	6dB
		0	0	0	1	1	1	7dB
		0	0	1	0	0	0	8dB
		0	0	1	0	0	1	9dB
		0	0	1	0	1	0	10dB
		0	0	1	0	1	1	11dB
		0	0	1	1	0	0	12dB
		0	0	1	1	0	1	13dB
		0	0	1	1	1	0	14dB
		0	0	1	1	1	1	15dB
		0	1	0	0	0	0	16dB
		0	1	0	0	0	1	17dB
		0	1	0	0	1	0	18dB
		0	1	0	0	1	1	19dB
		0	1	0	1	0	0	20dB
		1						LOUDNESS OFF
								FINE VOLUME
0	0							0dB
0	1							-0.25dB
1	0							-0.5dB
1	1							-0.75dB

## Mute

MSB							LSB	FUNCTION
D7	D6	D5	D4	D3	D2	D1	D0	
				0			1	Soft Mute On
				0		0	1	Soft Mute with fast slope
				0		1	1	Soft Mute with slow slope
			0	0	1			Zero Mute
				1				Direct Mute
			1					Reset
	0	0	0					Zerocross window (280mV)
	0	1	0					Zerocross window (140mV)
	1	0	0					Zerocross window (70mV)
	1	1	0					Zerocross window (35mV)
0								Nonsymmetrical Bass
1								Symmetrical Bass

## Volume

MSB							LSB	FUNCTION
D7	D6	D5	D4	D3	D2	D1	D0	
1					0	0	0	0dB
1					0	0	1	-1dB
1					0	1	0	-2dB
1					0	1	1	-3dB
1					1	0	0	-4dB
1					1	0	1	-5dB
1					1	1	0	-6dB
1					1	1	1	-7dB
1								
1	0	0	0	0				16dB
1	0	0	0	1				8dB
1	0	0	1	0				0dB
1	0	0	1	1				-8dB
1	0	1	0	0				-16dB
1	0	1	0	1				-24dB
1	0	1	1	0				-32dB
1	0	1	1	1				-40dB
1	1	0	0	0				-48dB
1	1	0	0	1				-56dB
0	X	X	X	X	X	X	X	MUTE

## Speaker

MSB							LSB		FUNCTION
D7	D6	D5	D4	D3	D2	D1	D0		
								<b>1.25dB step</b>	
					0	0	0	0dB	
					0	0	1	-1dB	
					0	1	0	-2dB	
					0	1	1	-3dB	
					1	0	0	-4dB	
					1	0	1	-5dB	
					1	1	0	-6dB	
					1	1	1	-7dB	
	0	0	0	0				0dB	
	0	0	0	1				-8dB	
	0	0	1	0				-16dB	
	0	0	1	1				-24dB	
	0	1	0	0				-32dB	
	0	1	0	1				-40dB	
	0	1	1	0				-48dB	
	0	1	1	1				-56dB	
	1	0	0	0				-64dB	
	1	0	0	1				-72dB	
	1	1	1	1	X	X	X	MUTE	

## Bass Treble

MSB							LSB		FUNCTION
D7	D6	D5	D4	D3	D2	D1	D0		
								TREBLE STEP	
				0	0	0	0	-14dB	
				0	0	0	1	-12dB	
				0	0	1	0	-10dB	
				0	0	1	1	-8dB	
				0	1	0	0	-6dB	
				0	1	0	1	-4dB	
				0	1	1	0	-2dB	
				0	1	1	1	0dB	
				1	1	1	1	0dB	
				1	1	1	0	2dB	
				1	1	0	1	4dB	
				1	1	0	0	6dB	
				1	0	1	1	8dB	
				1	0	1	0	10dB	
				1	0	0	1	12dB	
				1	0	0	0	14dB	
								BASS STEPS	
0	0	0	0					-14dB	
0	0	0	1					-12dB	
0	0	1	0					-10dB	
0	0	1	1					-8dB	
0	1	0	0					-6dB	
0	1	0	1					-4dB	
0	1	1	0					-2dB	
0	1	1	1					0dB	
1	1	1	1					0dB	
	1	1	0					2dB	
1	1	0	1					4dB	
	1	0	0					6dB	
1	0	1	1					8dB	
	0	1	0					10dB	
1	0	0	1					12dB	
1	0	0	0					14dB	

## Input Stage Gain Middle

MSB							LSB		FUNCTION
D7	D6	D5	D4	D3	D2	D1	D0		
								IN-GAIN STEP	
				0	0	0	0	0dB	
				0	0	0	1	1dB	
				0	0	1	0	2dB	
				0	0	1	1	3dB	
				0	1	0	0	4dB	
				0	1	0	1	5dB	
				0	1	1	0	6dB	
				0	1	1	1	7dB	
				1	0	0	0	8dB	
				1	0	0	1	9dB	
				1	0	1	0	10dB	
				1	0	1	1	11dB	
				1	1	0	0	12dB	
				1	1	0	1	13dB	
				1	1	1	0	14dB	
				1	1	1	1	15dB	
								MIDDLE STEP	
0	0	0	0					-14dB	
0	0	0	1					-12dB	
0	0	1	0					-10dB	
0	0	1	1					-8dB	
0	1	0	0					-6dB	
0	1	0	1					-4dB	
0	1	1	0					-2dB	
0	1	1	1					0dB	
1	1	1	1					0dB	
1	1	1	0					2dB	
1	1	0	1					4dB	
1	1	0	0					6dB	
1	0	1	1					8dB	
1	0	1	0					10dB	
1	0	0	1					12dB	
1	0	0	0					14dB	

### MUTE & PAUSE FEATURES

The TDA7437N provides three types of mute, controlled via I2C bus (see pag. 10, MUTE BYTE register).

#### SOFT MUTE

Bit **D0 = 1** → **Soft Mute ON**

Bit **D0 = 0** → **Soft Mute OFF**

It allows an automatic soft muting and unmuting of the signal.

The time constant is fixed by an external capacitor Csm inserted between pin Csm and ground.

Once fixed the external capacitor, two different slopes (time constant) are selectable by programming of bit D1.

Bit **D1 = 0** → **fast slope (I=Imax)**

Bit **D1 = 1** → **slow slope (I=Imin)**

The soft mute generates a gradual signal decreasing avoiding big click noise of an immediate high attenuation, without necessity to program a sequence of decreasing volume levels. A response example is reported in Fig.8 (mute) and Fig.9 (unmute). The final attenuation obtained with soft mute ON is 60dB typical. The used reference parameter is the delay time taken to reach 20dB attenuation (no matter what the signal level is).

Using a capacitor Csm = 22nF this delay is:

d = 1.8ms when selected Fast slope mode (bit D1=0)

d = 25 ms when selected Slow slope mode (bit D1=1)

In application, the soft mute ON programming should be followed by programming of DIRECT MUTE ON (see later) in order to achieve a final 100dB attenuation. Beside the I<sup>2</sup>C bus programming, the Soft Mute ON can be generated in a fast way by forcing a LOW level at pin SMEXT (TTL Level compatible). This approach is recommended for fast RDS AF switching.

The Soft Mute status can be detected via I<sup>2</sup>C bus, reading the Transmitted Byte, bit SM (see data sheet pag. 8).

read bit SM = 1 soft mute status ON

read bit SM = 0 soft mute status OFF

#### DIRECT MUTE

bit **D3 = 1** Direct mute ON

bit **D3 = 0** Direct mute OFF

The direct mute bit forces an internal immediate signal connection to ground.

It is located just before the Volume/Loudness stage, and gives a typical 100dB attenuation.

#### SPEAKERS MUTE

An additional direct mute function is included in the speakers attenuators stage.

The four output LF, RF, LR, RR can be separately muted by setting the speaker attenuator byte to the value 01111111 binary.

Typical attenuation level 100dB. This mute is useful for fader and balance functions. It should not be applied for system mute/unmute, because it can generate noise due to the offset of previous stages (bass /treble).

#### ZEROCROSSING MUTE

bit **D2 = 1 D4 = 0** zero crossing mute ON

bit **D2 = 0 D4 = 0** zero crossing mute OFF

The mute activation/deactivation is delayed until the signal waveform crosses the DC zero level (Vref level).

The detection works separately for the left and the right channels (see Figg. 10, 11). Four different windows threshold are software selectable by two dedicated bits.

bit **D6** bit **D5** **WINDOW**

<b>0</b>	<b>0</b>	Vref DC +/-280mV
<b>0</b>	<b>1</b>	Vref DC +/-140mV
<b>1</b>	<b>0</b>	Vref DC +/-70mV
<b>1</b>	<b>1</b>	Vref DC +/-35mV

The zero crossing mute activation/deactivation starts when the AC signal level falls inside the selected window (internal comparator).

The ZEROCROSS Mute (and Pause) detector is always active. It can be disabled, if the feature is not used, by forcing the bit **D4 = 1** Zero crossing and Pause detector reset.

In this way the internal comparator logic is stopped, eliminating its switching noise.

The zero cross mute status is detected reading the Transmitted Byte bit ZM.

bit **ZM = 1** zero cross mute status ON

bit **ZM = 0** zero cross mute status OFF

## PAUSE FUNCTION

On chip is implemented a pause detector block.

It uses the same 4 windows threshold selectable for the zero crossing mute, bit D6,D5 byte MUTE (see above). The detector can be put in OFF by forcing bit **D4 = 1**, otherwise it is active.

The Pause detector info is available at PAUSE pin. A capacitor must be connected between PAUSE pin and Ground.

When the incoming signal is detected to be outside the selected window, the external capacitor is discharged. When the signal is inside the window, the capacitor is integrating up (see Figg.12 and 13).

a by reading directly the Pause pin level. The ON/OFF voltage threshold is 3.0V typical. Pause OFF = level low (< 3.0V) Pause ON = level high ( ; 3.0V)

b by reading via I2C bus the Transmitted Byte, bit PP = 0 pause active. P = 1 no pause detected. The external capacitor value fixes the time constant.

The pull up current is 25uV typical With input signal

$V_{in} = 1V_{rms}$  --;  $V_{dc}$  pin pause = 15mV

$V_{in} = 0V_{rms}$  --;  $V_{dc}$  pin pause = 5.62V

For example choosing  $C_{pause} = 100nF$  the charge up constant is about 22ms. Instead with  $C_{pause} = 15nF$  the charge up constant is about 360µs.

The Pause detection is useful in applications like RDS, to perform noiseless tuning frequency jumps avoiding to mute the signal.

## NO SYMMETRICAL BASS CUT RESPONSE

bit **D7 = 0** No symmetrical

bit **D7 = 1** Symmetrical

The Bass stage has the option to generate an unsymmetrical response, for cut mode settings (bass level from -2db to -14dB)

For example using a T-type band pass externa

The feature is useful for human ear equalization in noisy environments like cars etc.

See examples in Fig. 14 (symmetrical response) and Fig. 15 (unsymmetrical response).

### TRANSMITTED DATA (SEND MODE)

bit **P = 0** Pause active

bit **P = 1** No pause detected

bit **ZM = 1** Zero cross mute ON

bit **ZM = 0** Zero cross mute OFF

bit **SM = 1** Soft mute ON

bit **SM = 0** Soft mute OFF

bit **ST = 1** Stereo signal detected (input MPX)

bit **ST = 0** Mono signal detected (input MPX)

The TDA7437N allows the reading of four info bits.

The type (Stereo/Mono) of received broadcasting signal is easily checked and displayed by using the **ST** bit.

The **P** bit check is useful in tuning jumps without signal muting.

The **SM** soft mute status becomes active immediately, when bit D0 is set to 1 (soft mute ON, MUTE byte) and not when the signal level has reached the 60 dB final attenuation.

### TDA7437N I<sup>2</sup>C BUS PROTOCOL

The protocol is standard I<sup>2</sup>C, using subaddress byte plus data bytes (see pagg. 8 to 13).

The optional Autoincrement mode allows to refresh all the bytes registers with transmission of a single subaddress, reducing drastically the total transmission time.

Without autoincrement, subaddress bit **I = 0**, to refresh all the bytes registers (10), it is necessary to transmit 10 times the chip address, the subaddress and the data byte.

Working with a 100Kb/s clock speed the total time would be :

$$[(9*3+2)*10]bits*10us=2.9ms$$

Instead using autoincrement mode, subaddress bit **I=1**, the total time will be:

$$(9*12+2)*10us=1.1ms.$$

The autoincrement mode is useful also to refresh partially the data. For example to refresh the 4 speakers attenuators it is possible to program the subaddress Spkr LF (code XX010100), followed by the data byte of SPKR LF, LR, RF, RR in sequence.

Note:that the autoincrement mode has a module 16 counter, whereas the total used register bytes are 10.

It is not correct to refresh all the 10 bytes starting from a subaddress different than XX010000.

For example using subaddress XX010010 (volume) the registers from Volume to Mute (see pag. 8) are correctly updated but the next two transmitted bytes instead to refer to the wanted Input selector and Loudness are discharged. (the solution in this case is to send two separated pattern in autoinc mode, the first composed by address, subaddress XX010010, 8 data bytes, and the second composed by address, subaddress XX010000, 2 data bytes).

With autoincrement disabled, the protocol allows the transmission in sequence of N data bytes of a specific register, without necessity to resend each time the address and subaddress bytes.

This feature can be implemented, for example, if a gradual Volume change has to be performed (the MCU has not to send the STOP condition, keeping active the TDA7437N communication)

### WARNING

The TDA7437N always needs to receive a STOP condition, before beginning a new START condition. The de-



vice doesn't recognize a START condition if a previously active communication was not ended by a STOP condition.

### I<sup>2</sup>C BUS READ MODE

The TDA7437N gives to the master a 1 byte "TRANSMITTED INFO" via I<sup>2</sup>C bus in read mode. The read mode is Master activated by sending the chip address with LSB set to 1, followed by acknowledge bit.

The TDA7437N recognizes the request. At the following master generated clocks bits, the TDA7437N issues the TRANSMITTED INFO byte on the SDA data bus line (MSB transmitted first).

At the ninth clock bit the MCU master can:

- acknowledge the reception, starting in this way the transmission of another byte from the TDA7437N.
- no acknowledge, stopping the read mode communication.

### LOUDNESS STAGE

The previous SGS-THOMSON audioprocessors were implementing a fixed loudness response, only ON/OFF sw programmable.

No possibility to change the loud boost rate at a certain volume level. The TDA7437N implements a fully programmable loudness control in 20 steps of 1dB.

It allows a customized loudness response for each application. The external network connected to the loudness pins LOUD\_L and LOUD\_R fixes the type of loudness response

- 1) Simple Capacitor The loudness effect is only a boost of low frequencies. (see Fig. 16)
- 2) Second order Loudness (boost of low and high frequencies).
- 3) Second order decreased type Loudness (lower boost of low and high frequencies).
- 4) Second order modified type Loudness (higher boost of low and high frequencies).

### BASS & MID FILTERS

Several bass filter types can be implemented. Normally it is used the basic T-type Bandpass Filter. Starting from the filter component values (R1 internal and R2, C1, C2 external), the centre frequency F<sub>c</sub>, the gain A<sub>v</sub> at max bass boost and the filter Q factor are computed as follows

$$F_c = \frac{1}{2 \cdot \Pi \cdot \sqrt{R1 \cdot R2 \cdot C1 \cdot C2}}$$

$$A_v = \frac{R2 \cdot C2 + R2 \cdot C1 + R1 \cdot C1}{R2 \cdot C1 + R2 \cdot C2}$$

$$Q = \frac{\sqrt{(R1 \cdot R2 \cdot C1 \cdot C2)}}{R2 \cdot C1 + R2 \cdot C2}$$

Viceversa fixed F<sub>c</sub>, A<sub>v</sub>, and R1 (internal typ. ±30%), the external component values are

$$C1 = \frac{A_v - 1}{2 \cdot \Pi \cdot R1 \cdot Q}$$

$$C2 = \frac{Q \cdot Q \cdot C1}{A_v - 1 - Q \cdot Q}$$

$$R2 = \frac{A_V - 1 - Q \cdot Q}{2 \cdot \Pi \cdot C1 \cdot F_c \cdot (A_V - 1) \cdot Q}$$

**TREBLE STAGE**

The Treble stage is a simple high pass filter which time constant is fixed by internal resistor (50Kohm typ) and an external capacitor connected between pins TREB\_R/TREB\_L and Ground.

**IN-OUT PINS**

The multiplexer output is available at OUT\_R and OUT\_L pins for optional connection of external graphic equalizer (TDA7316/TDA7317), surround chip (TDA7346) etc. The signal is fed in again at pins IN\_L and IN-R. In case of application without external devices the pins OUT\_L/OUT\_R and IN\_L/IN\_R can be left unconnected if bit D3 byte input selector is forced = 0 (DC connect) instead if bit D3 is kept = 1 an external decoupling capacitor must be provided between OUTF/INR and OUTL/INR necessary to avoid signal DC jumps, generating "Clicking" output noise. The input impedance of the next volume stage is 44Kohm typical (minimum 31Kohm). A capacitor no lower than 1mF should be used.

**INPUT SELECTOR**

The multiplexer selector can choose one of the following inputs:

- a differential CD stereo input.
- a mono input.
- four stereo input

The signal fed to the input pins must be decoupled via series capacitors. The minimum allowed value depends on the correspondent input impedance. For the CD diff input ( $Z_i = 10\text{Kohm}$  worst case ) a  $C_{in} = 4.7\mu\text{F}$  is recommended. For the other inputs ( $70\text{Kohm}$  worst case, a  $C_{in} = 1\mu\text{F}$  is recommended.

**Figure 4. Power on Time Constant vs  $C_{REF}$**   
 Capacitor  $C_{REF} = 4.7\mu F$

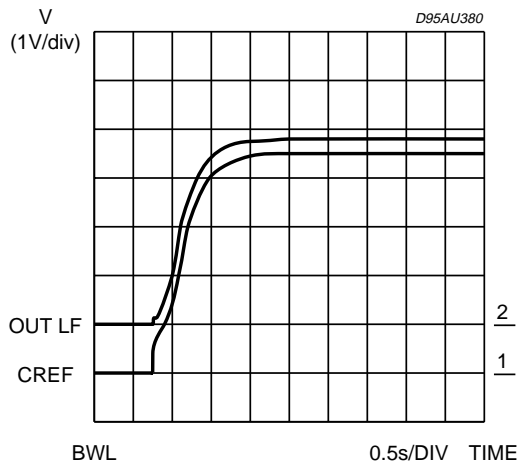

**Figure 5. Power on Time Constant vs  $C_{REF}$**   
 Capacitor  $C_{REF} = 10\mu F$

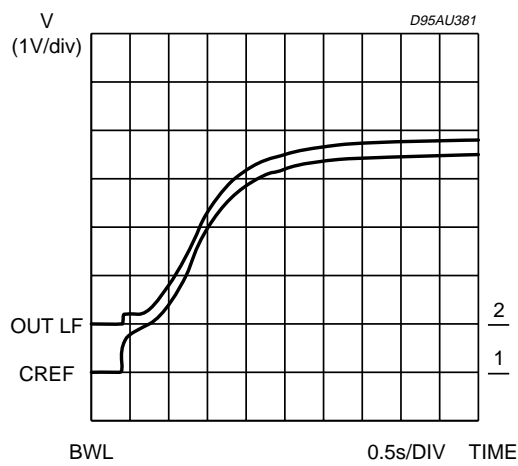

**Figure 6. Power on Time Constant vs  $C_{REF}$**   
 Capacitor  $C_{REF} = 22\mu F$

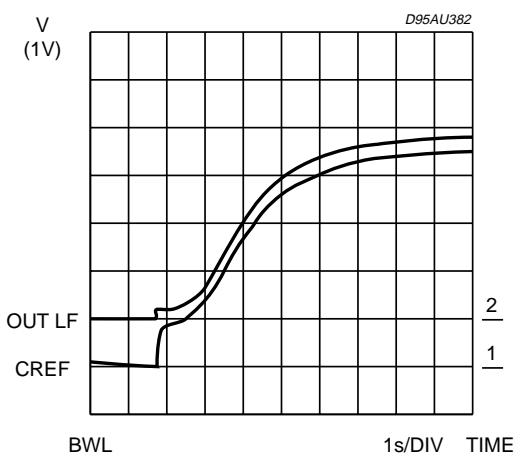

**Figure 7. SVRR vs. Frequency**

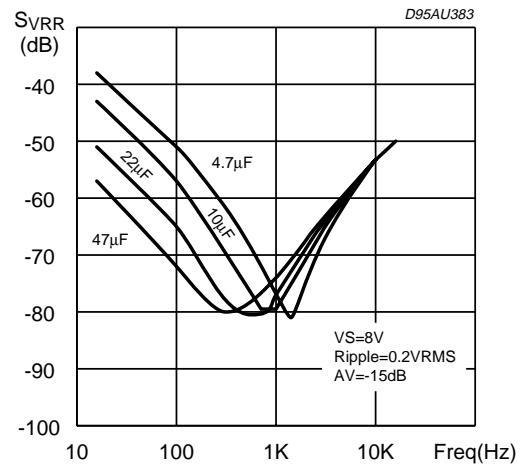

**Figure 8. Soft Mute ON**

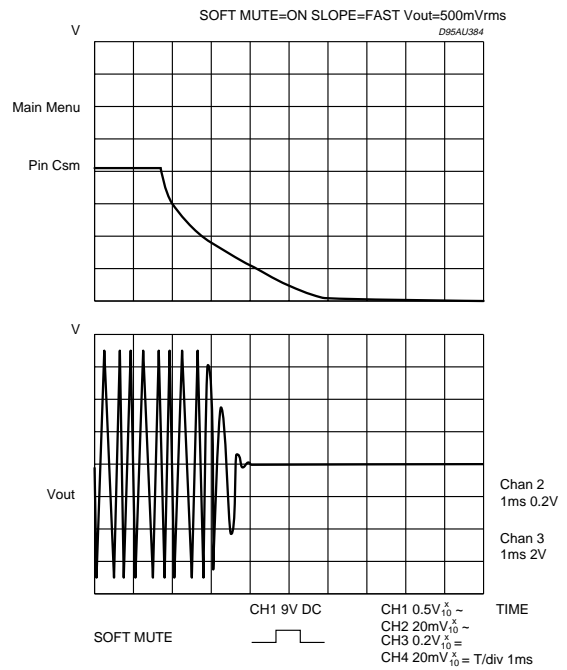

Figure 9. Soft Mute OFF

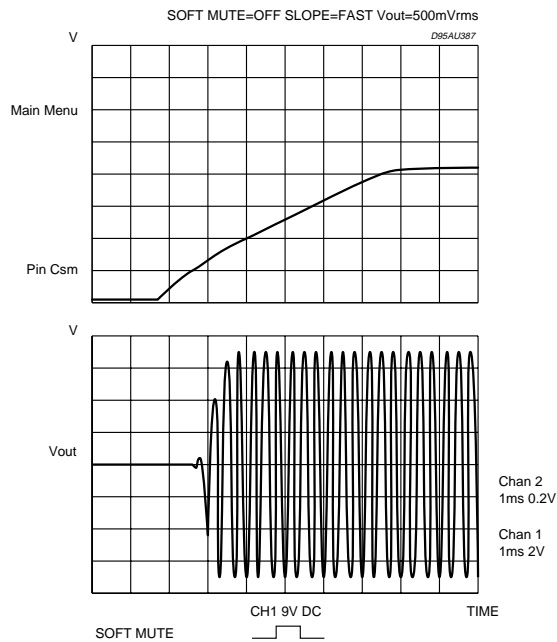

Figure 10. Zero Crossing Mute ON

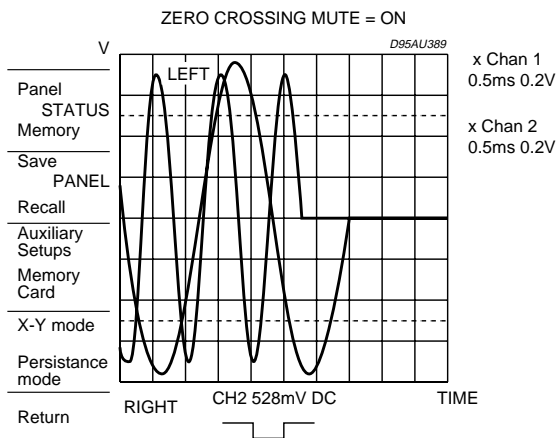

Figure 11. Zero Crossing Mute OFF

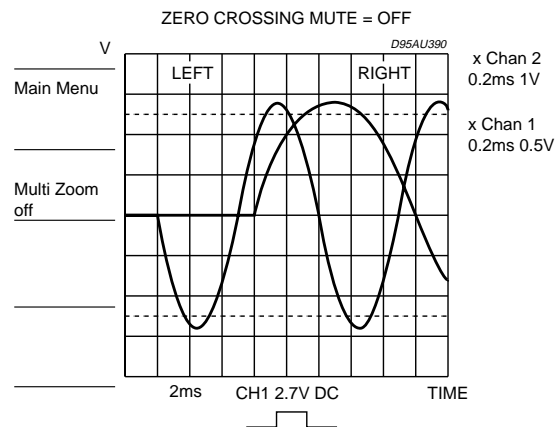

Figure 12. Pause Detector

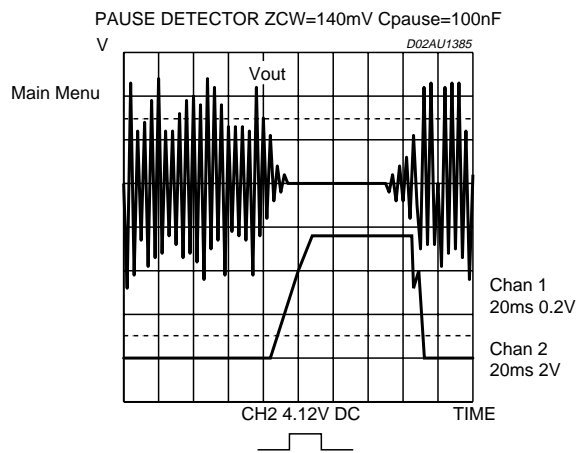

Figure 13. Pause Detector

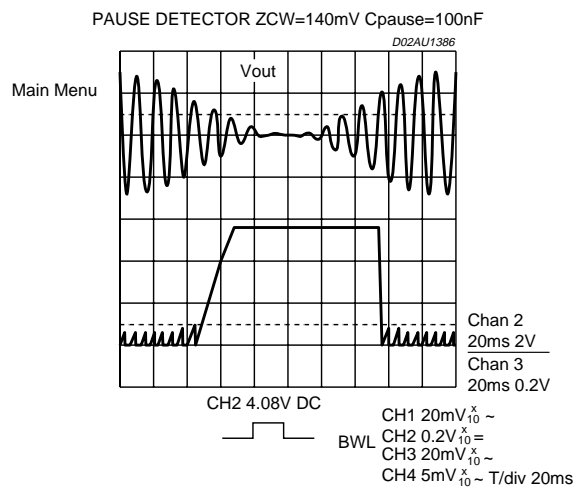

Figure 14. Sym\_Bass

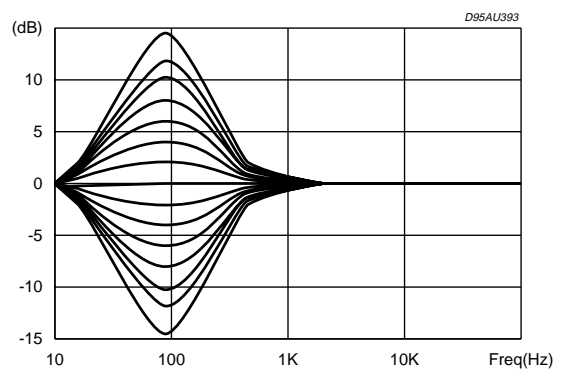

Figure 15. Non\_Sym\_Bass

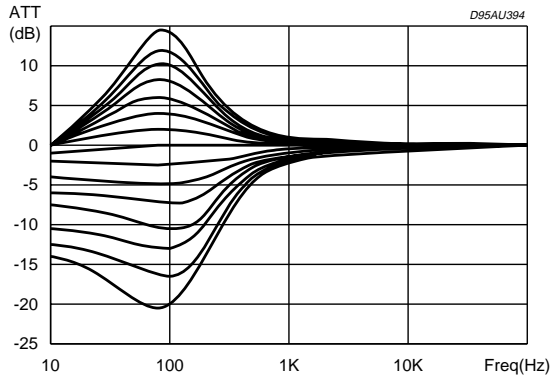

Figure 16. Loudness

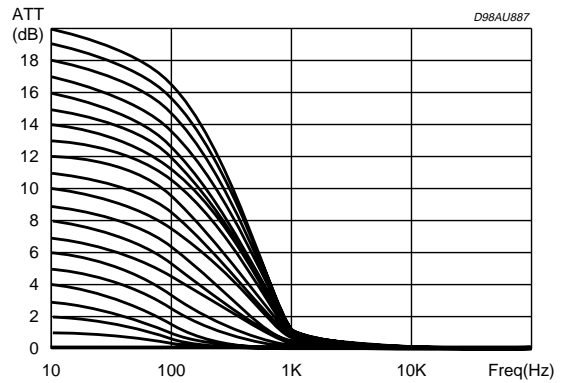
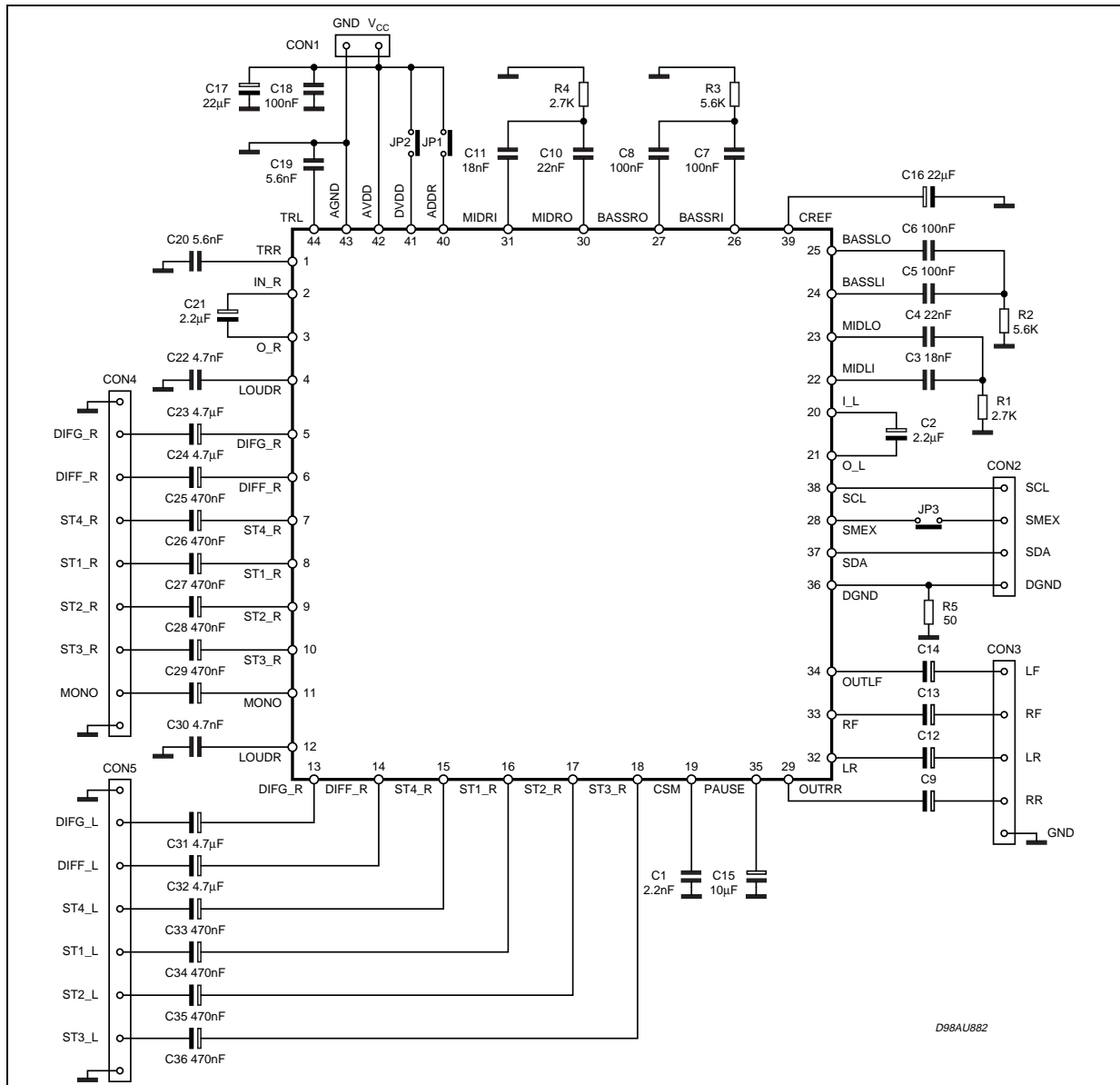
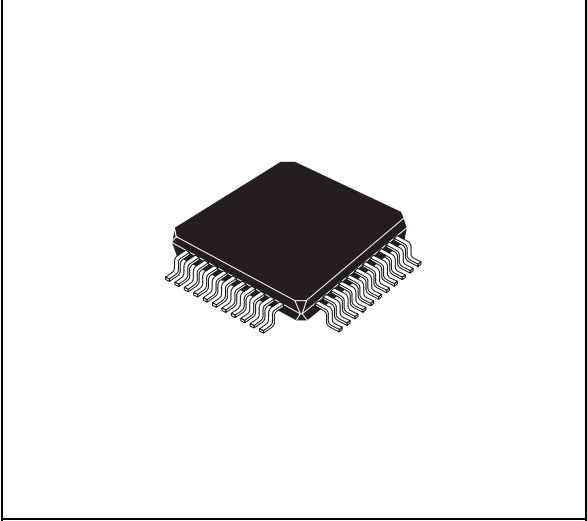

Figure 17. Test Board Diagram



DIM.	mm			inch		
	MIN.	TYP.	MAX.	MIN.	TYP.	MAX.
A			1.60			0.063
A1	0.05		0.15	0.002		0.006
A2	1.35	1.40	1.45	0.053	0.055	0.057
B	0.30	0.37	0.45	0.012	0.015	0.018
C	0.09		0.20	0.004		0.008
D	11.80	12.00	12.20	0.464	0.472	0.480
D1	9.80	10.00	10.20	0.386	0.394	0.401
D3		8.00			0.315	
E	11.80	12.00	12.20	0.464	0.472	0.480
E1	9.80	10.00	10.20	0.386	0.394	0.401
E3		8.00			0.315	
e		0.80			0.031	
L	0.45	0.60	0.75	0.018	0.024	0.030
L1		1.00			0.039	
k	0° (min.), 3.5° (typ.), 7° (max.)					

**OUTLINE AND MECHANICAL DATA**



**TQFP44 (10 x 10 x 1.4mm)**

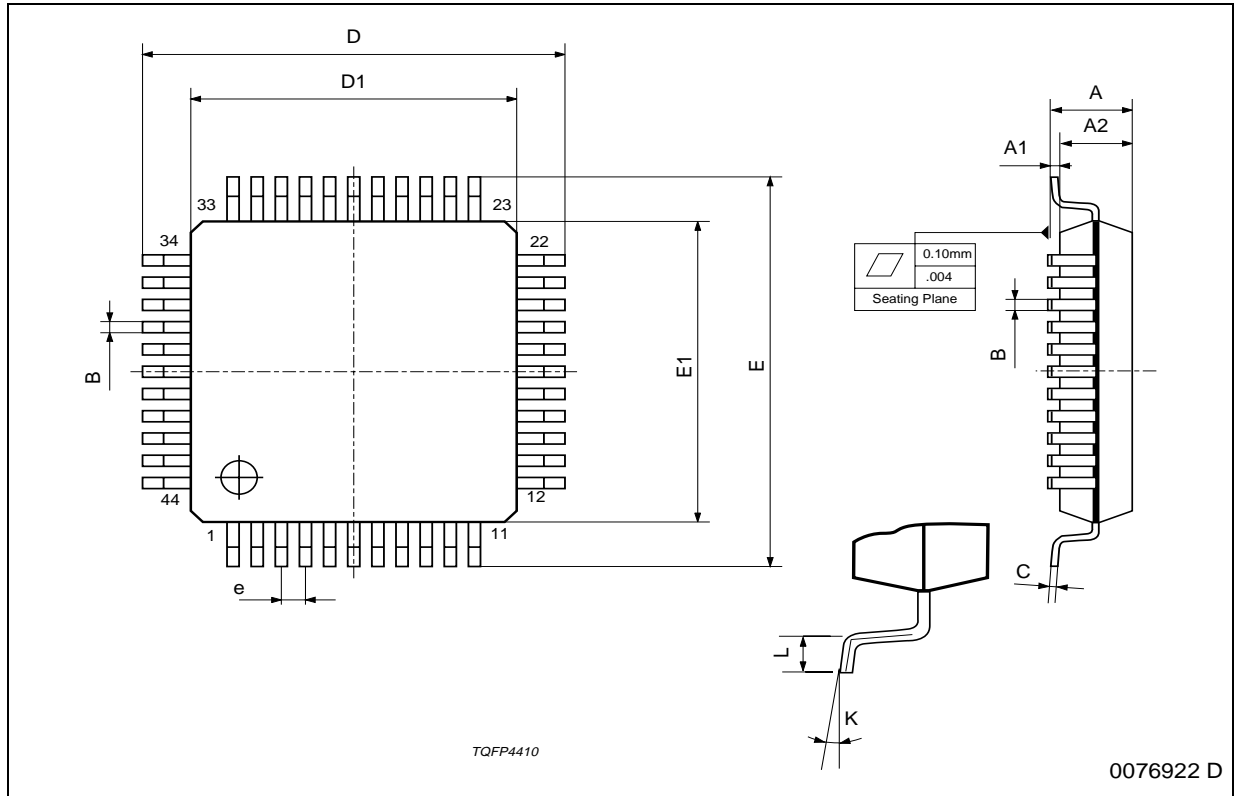

Purchase of I<sup>2</sup>C Components of STMicroelectronics, conveys a license under the Philips I<sup>2</sup>C Patent Rights to use these components in an I<sup>2</sup>C system, provided that the system conforms to the I<sup>2</sup>C Standard Specifications as defined by Philips.

Information furnished is believed to be accurate and reliable. However, STMicroelectronics assumes no responsibility for the consequences of use of such information nor for any infringement of patents or other rights of third parties which may result from its use. No license is granted by implication or otherwise under any patent or patent rights of STMicroelectronics. Specifications mentioned in this publication are subject to change without notice. This publication supersedes and replaces all information previously supplied. STMicroelectronics products are not authorized for use as critical components in life support devices or systems without express written approval of STMicroelectronics.

The ST logo is a registered trademark of STMicroelectronics.  
All other names are the property of their respective owners

© 2003 STMicroelectronics - All rights reserved

**STMicroelectronics GROUP OF COMPANIES**

Australia - Belgium - Brazil - Canada - China - Czech Republic - Finland - France - Germany - Hong Kong - India - Israel - Italy - Japan -  
Malaysia - Malta - Morocco - Singapore - Spain - Sweden - Switzerland - United Kingdom - United States

[www.st.com](http://www.st.com)