Designated client product

This product will be discontinued its production in the near term.
And it is provided for customers currently in use only, with a time limit.
It can not be available for your new project. Please select other new or existing products.

For more information, please contact our sales office in your region.

New Japan Radio Co.,Ltd.

www.njr.com

QUAD OPERATIONAL AMPLIFIER

■ GENERAL DESCRIPTION

NJM2112 is low operating voltage ($\pm 1.0V$ min.) and low saturation output voltage ($\pm 2.0V_{P-P}$ at operating voltage $\pm 2.5V$) operational amplifier. It is applicable to HANDY TYPE CD, RADIO CASSETTE CD, and PORTABLE DAT, that are digital audio apparatus which require the 5V single supply operation and high output voltage. The NJM2112 is quad operational amplifier. Each amplifier of the NJM2112 has the same electrical characteristic of the NJM2115.

■ FEATURES

- Operating Voltage ($\pm 1.0V \sim \pm 7.0V$)
- Low Saturation Output Voltage ($\pm 2.0V_{P-P}$ @ $V^+ = \pm 2.5V$)
- Package Outline DIP14, DMP14, SSOP14
- Bipolar Technology

■ PIN CONFIGURATION

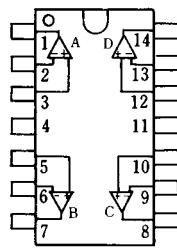

NJM2112D
NJM2112M
NJM2112V

■ PACKAGE OUTLINE

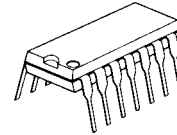

NJM2112D

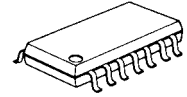

NJM2112M



NJM2112V

PIN FUNCTION

1. A OUTPUT
2. A -INPUT
3. A +INPUT
4. V^+
5. B +INPUT
6. B -INPUT
7. B OUTPUT
8. C OUTPUT
9. C -INPUT
10. C +INPUT
11. V^-
12. D +INPUT
13. D -INPUT
14. D OUTPUT

■ EQUIVALENT CIRCUIT (1/4 Shown)

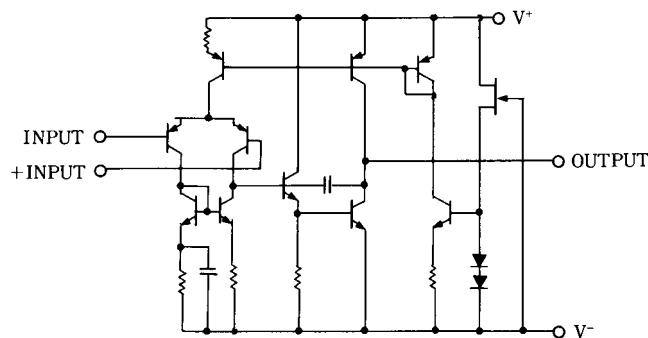

NJM2112

■ ABSOLUTE MAXIMUM RATINGS

(Ta=25°C)

PARAMETER	SYMBOL	RATINGS	UNIT
Supply Voltage	V^+ / V^-	± 7.0	V
Differential Input Voltage	V_{ID}	± 14	V
Power Dissipation	P_D	(DIP14) 500 (DMP14) 300 (SSOP14) 300	mW
Operating Temperature Range	T_{opr}	-40~+85	°C
Storage Temperature Range	T_{stg}	-40~+125	°C

■ ELECTRICAL CHARACTERISTICS

($V^+ / V^- = \pm 2.5V, Ta=25^\circ C$)

PARAMETER	SYMBOL	TEST CONDITION	MIN.	TYP.	MAX.	UNIT
Input Offset Voltage	V_{IO}	$R_S \leq 10k\Omega$	-	1	6	mV
Input Bias Current	I_B		-	100	300	nA
Large signal Voltage Gain	A_V	$R_L \geq 10k\Omega$	60	80	-	dB
Maximum Output Voltage Swing	V_{OM}	$R_L \geq 2.5k\Omega$	± 2	± 2.2	-	V
Input Common Mode Voltage Range	V_{ICM}		± 1.5	-	-	V
Common Mode Rejection Ratio	CMR		60	74	-	dB
Supply Voltage Rejection Ratio	SVR		60	80	-	dB
Operating Current	I_{CC}	$V_{IN}=0, R_L=\infty$	-	8	11	mA
Slew Rate	SR	$A_V=1, V_{IN}=\pm 1V$	-	3.2	-	V/ μs
Gain Bandwidth Product	GB	$f=10kHz$	-	9	-	MHz

(Note1) Applied circuit voltage gain is desired to be operated within the range of 3dB to 30 dB.

(Note2) Special care being required for input common mode voltage range and the oscillation due to the capacitive load when operating on voltage follower.

■ TYPICAL CHARACTERISTICS

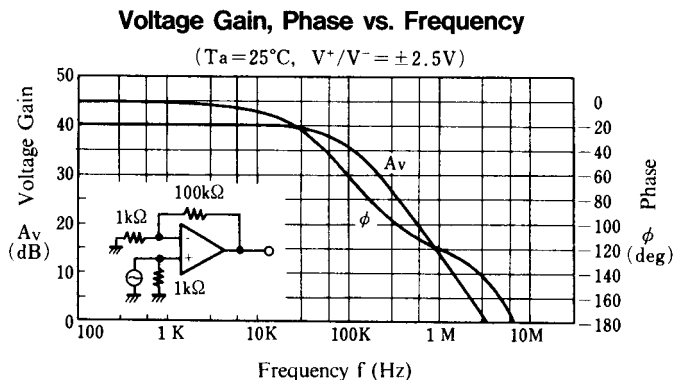

Total Harmonic Distortion vs. Output Voltage

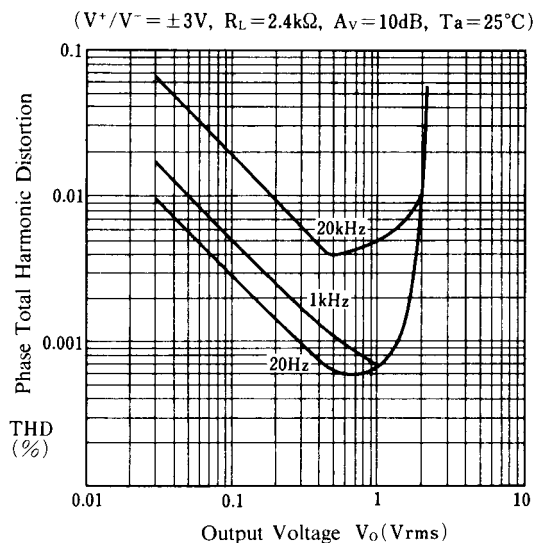

Equivalent Input Noise Voltage vs. Source Resistance

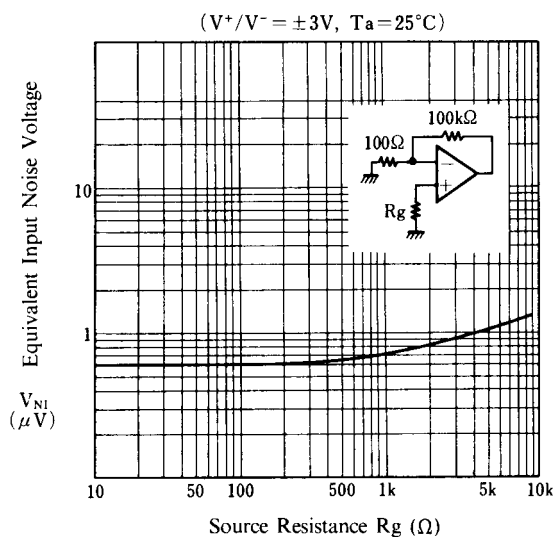

Operating Current vs. Operating Voltage

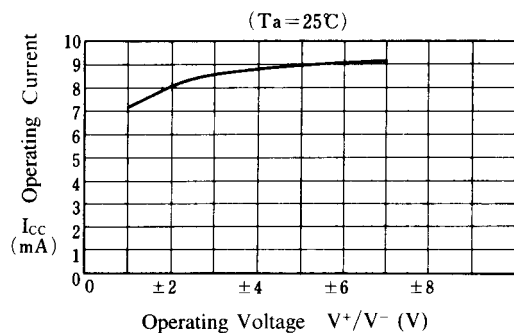

Input Offset Voltage vs. Operating Voltage

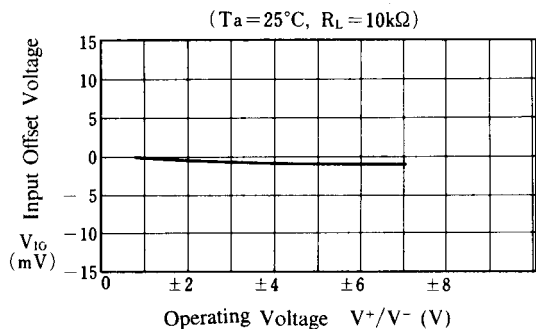

Maximum Output Voltage Swing vs. Operating Voltage

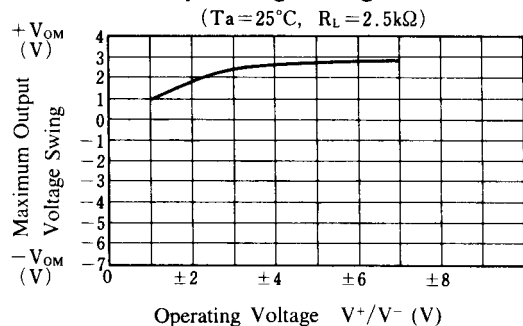

■ TYPICAL CHARACTERISTICS

Input Bias Current vs. Operating Voltage

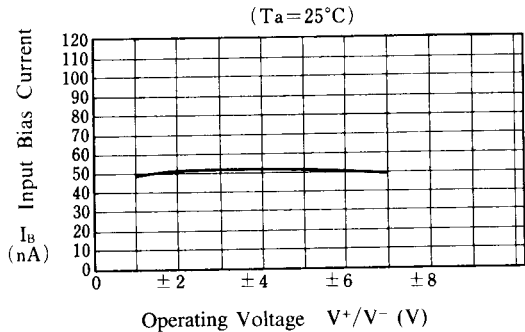

Maximum Output Voltage Swing vs. Load Resistance

($V^+/V^- = \pm 2.5\text{V}$, $T_a = 25^\circ\text{C}$)

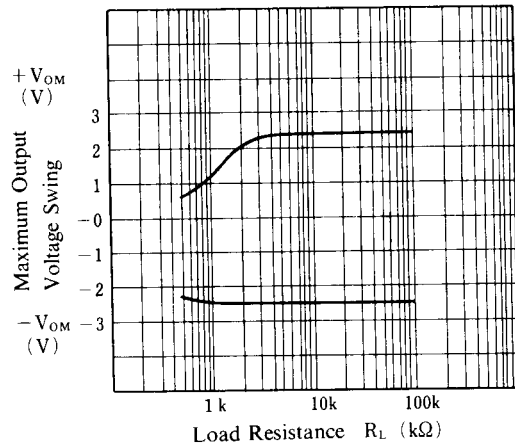

Operating Current vs. Temperature

($V^+/V^- = \pm 2.5\text{V}$)

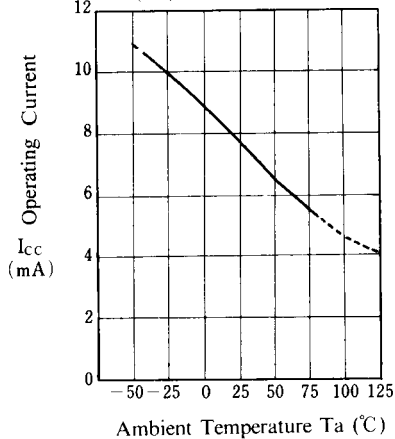

Input Offset Voltage vs. Temperature

($V^+/V^- = \pm 2.5\text{V}$, $R_L = 10\text{k}\Omega$)

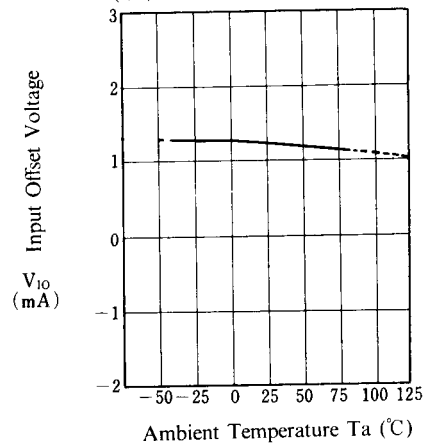

Input Bias Current vs. Temperature

($V^+/V^- = \pm 2.5\text{V}$)

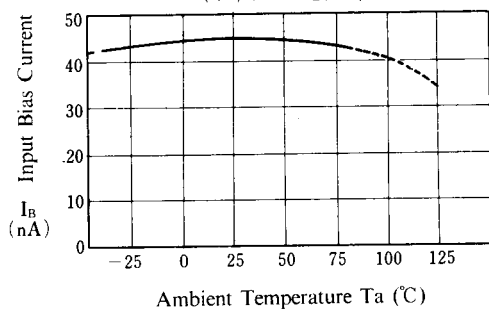

Maximum Output Voltage Swing vs. Temperature

($V^+/V^- = \pm 2.5\text{V}$, $R_L = 2.5\text{k}\Omega$)

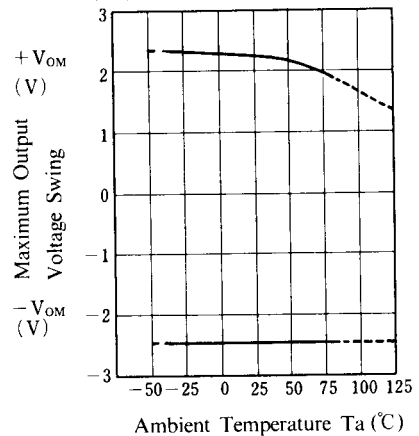

[CAUTION]

The specifications on this databook are only given for information, without any guarantee as regards either mistakes or omissions. The application circuits in this databook are described only to show representative usages of the product and not intended for the guarantee or permission of any right including the industrial rights.