

Features

- Ultra-Small Surface Mount Package
- Fast Switching Speed
- For General Purpose Switching Applications
- High Conductance
- Available in Lead Free/RoHS Compliant Version (Note 2)

Mechanical Data

- Case: SOT-523, Molded Plastic
- Case material - UL Flammability Rating 94V-0
- Moisture sensitivity: Level 1 per J-STD-020C
- Terminals: Solderable per MIL-STD-202, Method 208
- Also Available in Lead Free Plating (Matte Tin Finish). Please see Ordering Information, Note 4, on Page 2
- Polarity: See Diagrams Below
- Marking: See Diagrams Below & Page 3
- Weight: 0.002 grams (approx.)
- Ordering Information, see Page 2

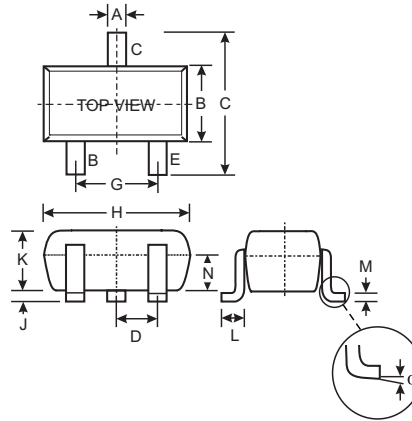

SOT-523			
Dim	Min	Max	Typ
A	0.15	0.30	0.22
B	0.75	0.85	0.80
C	1.45	1.75	1.60
D	—	—	0.50
G	0.90	1.10	1.00
H	1.50	1.70	1.60
J	0.00	0.10	0.05
K	0.60	0.80	0.75
L	0.10	0.30	0.22
M	0.10	0.20	0.12
N	0.45	0.65	0.50
α	0°	8°	—
All Dimensions in mm			

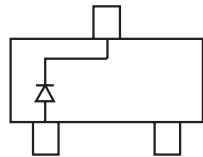

BAS16T Marking: A2

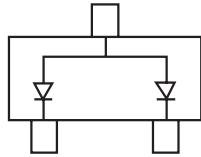

BAW56T Marking: JD

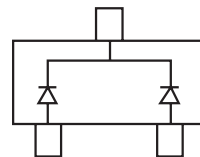

BAV70T Marking: JJ

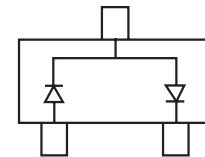

BAV99T Marking: JE

Maximum Ratings @ $T_A = 25^\circ\text{C}$ unless otherwise specified

Characteristic	Symbol	Value	Unit
Peak Repetitive Reverse Voltage Working Peak Reverse Voltage DC Blocking Voltage	V_{RRM} V_{RWM} V_R	85	V
RMS Reverse Voltage	$V_{R(RMS)}$	60	V
Forward Continuous Current (Note 2)	I_{FM}	155 75	mA
Repetitive Peak Forward Current	I_{FRM}	500	mA
Non-Repetitive Peak Forward Surge Current	I_{FSM}	4.0 1.0 0.5	A
		@ $t = 1.0\mu\text{s}$ @ $t = 1.0\text{ms}$ @ $t = 1.0\text{s}$	
Power Dissipation (Note 2)	P_d	150	mW
Thermal Resistance Junction to Ambient (Note 2)	$R_{\theta JA}$	833	$^\circ\text{C/W}$
Operating and Storage Temperature Range	T_j, T_{STG}	-65 to +150	$^\circ\text{C}$

Electrical Characteristics @ $T_A = 25^\circ\text{C}$ unless otherwise specified

Characteristic	Symbol	Min	Max	Unit	Test Condition
Reverse Breakdown Voltage (Note 1)	$V_{(BR)R}$	85	—	V	$I_R = 100\mu\text{A}$
Forward Voltage (Note 1)	V_F	—	0.715 0.855 1.0 1.25	V	$I_F = 1.0\text{mA}$ $I_F = 10\text{mA}$ $I_F = 50\text{mA}$ $I_F = 150\text{mA}$
Leakage Current (Note 1)	I_R	—	2.0 100 60 30	μA μA μA nA	$V_R = 75\text{V}$ $V_R = 75\text{V}, T_j = 150^\circ\text{C}$ $V_R = 25\text{V}, T_j = 150^\circ\text{C}$ $V_R = 25\text{V}$
Typical Total Capacitance	C_T	—	1.5	pF	$V_R = 0, f = 1.0\text{MHz}$
Reverse Recovery Time	t_{rr}	—	4.0	ns	$I_F = I_R = 10\text{mA}$, $t_{rr} = 0.1 \times I_R, R_L = 100\Omega$

- Notes:
- Short duration test pulse to minimize self-heating effect.
 - Device mounted on FR-4 PC board with recommended pad layout, which can be found on our website at <http://www.diodes.com/datasheets/ap02001.pdf>.

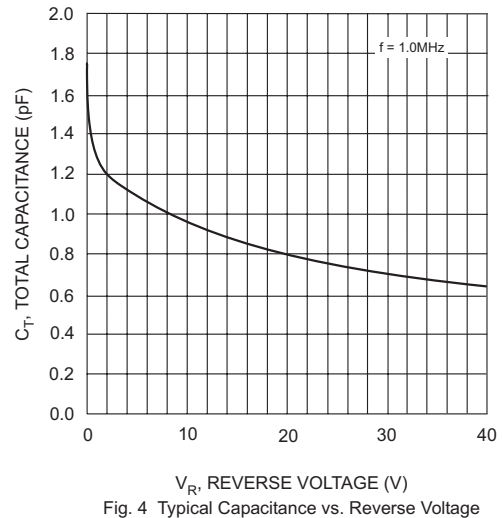
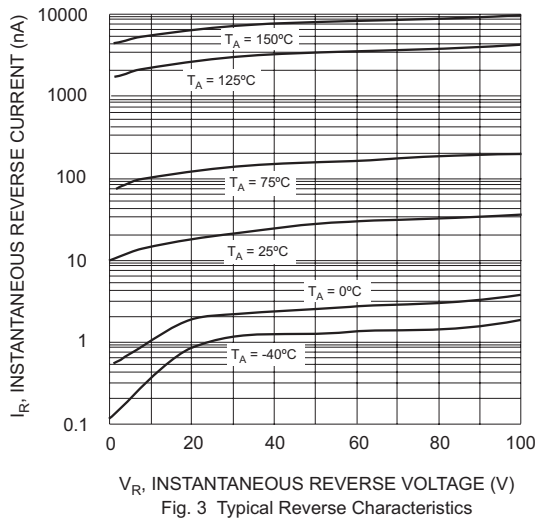
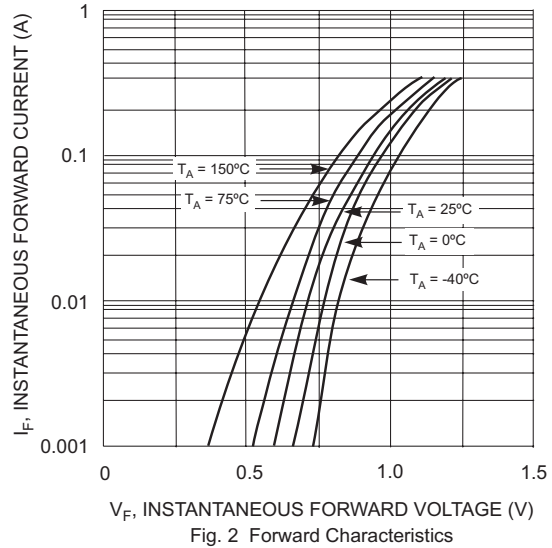
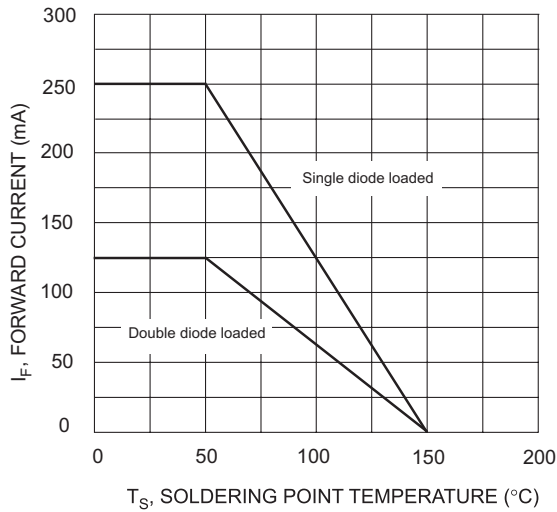

Ordering Information (Note 3)

Device	Packaging	Shipping
BAS16T-7	SOT-523	3000/Tape & Reel
BAW56T-7	SOT-523	3000/Tape & Reel
BAV70T-7	SOT-523	3000/Tape & Reel
BAV99T-7	SOT-523	3000/Tape & Reel

- Notes:
- For Packaging Details, go to our website at <http://www.diodes.com/datasheets/ap02007.pdf>.
 - For Lead Free/RoHS Compliant version part number, please add "-F" suffix to part number above.
Example: BAW56T-7-F.

Marking Information

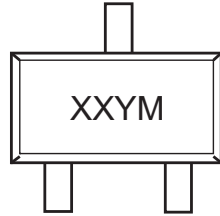

XX = Product Type Marking Code (See Page 1, e.g. A2 = BAS16T)
YM = Date Code Marking
Y = Year (ex: N = 2002)
M = Month (ex: 9 = September)

Date Code Key

Year	2002	2003	2004	2005	2006	2007	2008	2009
Code	N	P	R	S	T	U	V	W

Month	Jan	Feb	March	Apr	May	Jun	Jul	Aug	Sep	Oct	Nov	Dec
Code	1	2	3	4	5	6	7	8	9	O	N	D