

**POWER MOS V®**

Power MOS V® is a new generation of high voltage N-Channel enhancement mode power MOSFETs. This new technology minimizes the JFET effect, increases packing density and reduces the on-resistance. Power MOS V® also achieves faster switching speeds through optimized gate layout.

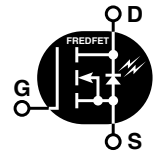
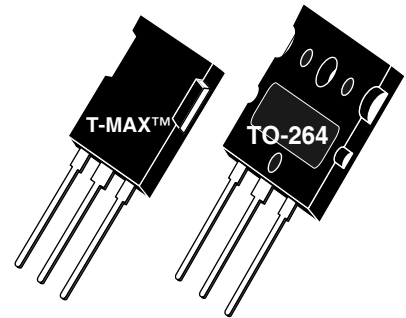

- **Faster Switching**
- **Lower Leakage**
- **Avalanche Energy Rated**
- **Popular T-MAX™ or TO-264 Package**

**MAXIMUM RATINGS**

 All Ratings:  $T_C = 25^\circ\text{C}$  unless otherwise specified.

Symbol	Parameter	APT12080B2VFR_LVFR	UNIT
$V_{DSS}$	Drain-Source Voltage	1200	Volts
$I_D$	Continuous Drain Current @ $T_C = 25^\circ\text{C}$	16	Amps
$I_{DM}$	Pulsed Drain Current <sup>①</sup>	64	
$V_{GS}$	Gate-Source Voltage Continuous	$\pm 30$	Volts
$V_{GSM}$	Gate-Source Voltage Transient	$\pm 40$	
$P_D$	Total Power Dissipation @ $T_C = 25^\circ\text{C}$	520	Watts
	Linear Derating Factor	4.16	W/°C
$T_J, T_{STG}$	Operating and Storage Junction Temperature Range	-55 to 150	°C
$T_L$	Lead Temperature: 0.063" from Case for 10 Sec.	300	
$I_{AR}$	Avalanche Current <sup>①</sup> (Repetitive and Non-Repetitive)	16	Amps
$E_{AR}$	Repetitive Avalanche Energy <sup>①</sup>	50	mJ
$E_{AS}$	Single Pulse Avalanche Energy <sup>④</sup>	2500	

**STATIC ELECTRICAL CHARACTERISTICS**

Symbol	Characteristic / Test Conditions	MIN	TYP	MAX	UNIT
$BV_{DSS}$	Drain-Source Breakdown Voltage ( $V_{GS} = 0V, I_D = 250\mu A$ )	1200			Volts
$R_{DS(on)}$	Drain-Source On-State Resistance <sup>②</sup> ( $V_{GS} = 10V, I_D = 8A$ )			0.800	Ohms
$I_{DSS}$	Zero Gate Voltage Drain Current ( $V_{DS} = 1200, V_{GS} = 0V$ )			250	$\mu A$
	Zero Gate Voltage Drain Current ( $V_{DS} = 960V, V_{GS} = 0V, T_C = 125^\circ\text{C}$ )			1000	
$I_{GSS}$	Gate-Source Leakage Current ( $V_{GS} = \pm 30V, V_{DS} = 0V$ )			$\pm 100$	nA
$V_{GS(th)}$	Gate Threshold Voltage ( $V_{DS} = V_{GS}, I_D = 2.5mA$ )	2		4	Volts

 **CAUTION:** These Devices are Sensitive to Electrostatic Discharge. Proper Handling Procedures Should Be Followed.

**DYNAMIC CHARACTERISTICS**

**APT12080B2VFR\_LVFR**

Symbol	Characteristic	Test Conditions	MIN	TYP	MAX	UNIT
C <sub>ISS</sub>	Input Capacitance	V <sub>GS</sub> = 0V V <sub>DS</sub> = 25V f = 1 MHz		6500	7800	pF
C <sub>OSS</sub>	Output Capacitance			530	740	
C <sub>RSS</sub>	Reverse Transfer Capacitance			250	375	
Q <sub>g</sub>	Total Gate Charge <sup>③</sup>	V <sub>GS</sub> = 10V V <sub>DD</sub> = 0.5 V <sub>DSS</sub> I <sub>D</sub> = I <sub>D</sub> [Cont.] @ 25°C		325	485	nC
Q <sub>gs</sub>	Gate-Source Charge			29	45	
Q <sub>gd</sub>	Gate-Drain ("Miller") Charge			145	215	
t <sub>d(on)</sub>	Turn-on Delay Time	V <sub>GS</sub> = 15V V <sub>DD</sub> = 0.5 V <sub>DSS</sub> I <sub>D</sub> = I <sub>D</sub> [Cont.] @ 25°C R <sub>G</sub> = 0.6Ω		16	32	ns
t <sub>r</sub>	Rise Time			12	24	
t <sub>d(off)</sub>	Turn-off Delay Time			59	90	
t <sub>f</sub>	Fall Time			12	24	

**SOURCE-DRAIN DIODE RATINGS AND CHARACTERISTICS**

Symbol	Characteristic / Test Conditions	MIN	TYP	MAX	UNIT
I <sub>S</sub>	Continuous Source Current (Body Diode)			16	Amps
I <sub>SM</sub>	Pulsed Source Current <sup>①</sup> (Body Diode)			64	
V <sub>SD</sub>	Diode Forward Voltage <sup>②</sup> (V <sub>GS</sub> = 0V, I <sub>S</sub> = -I <sub>D</sub> [Cont.])			1.3	Volts
dv/dt	Peak Diode Recovery dv/dt <sup>⑤</sup>			18	V/ns
t <sub>rr</sub>	Reverse Recovery Time (I <sub>S</sub> = -I <sub>D</sub> [Cont.], di/dt = 100A/μs)	T <sub>j</sub> = 25°C		350	ns
		T <sub>j</sub> = 125°C		700	
Q <sub>rr</sub>	Reverse Recovery Charge (I <sub>S</sub> = -I <sub>D</sub> [Cont.], di/dt = 100A/μs)	T <sub>j</sub> = 25°C		2	μC
		T <sub>j</sub> = 125°C		6	
I <sub>RRM</sub>	Peak Recovery Current (I <sub>S</sub> = -I <sub>D</sub> [Cont.], di/dt = 100A/μs)	T <sub>j</sub> = 25°C		12	Amps
		T <sub>j</sub> = 125°C		22	

**THERMAL CHARACTERISTICS**

Symbol	Characteristic	MIN	TYP	MAX	UNIT
R <sub>θJC</sub>	Junction to Case			0.24	°C/W
R <sub>θJA</sub>	Junction to Ambient			40	

- ① Repetitive Rating: Pulse width limited by maximum junction temperature.
- ② Pulse Test: Pulse width < 380 μs, Duty Cycle < 2%
- ③ See MIL-STD-750 Method 3471
- ④ Starting T<sub>j</sub> = +25°C, L = 19.53mH, R<sub>G</sub> = 25Ω, Peak I<sub>L</sub> = 16A
- ⑤ I<sub>S</sub> ≤ I<sub>D</sub> [Cont.], di/dt = 100A/μs, T<sub>j</sub> ≤ 150°C, R<sub>G</sub> = 2.0Ω V<sub>R</sub> = 200V.

**APT Reserves the right to change, without notice, the specifications and information contained herein.**

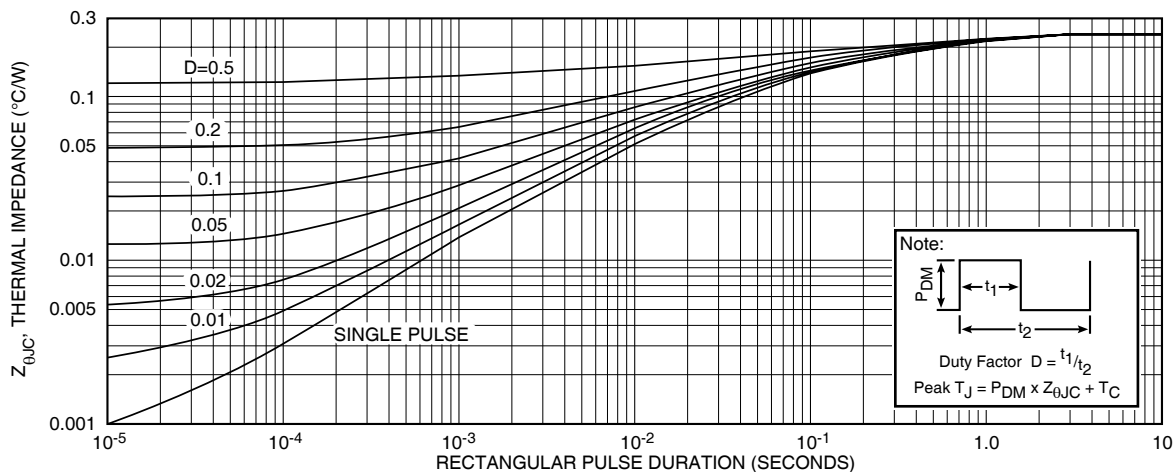

**FIGURE 1, MAXIMUM EFFECTIVE TRANSIENT THERMAL IMPEDANCE, JUNCTION-TO-CASE vs PULSE DURATION**

Typical Performance Curves

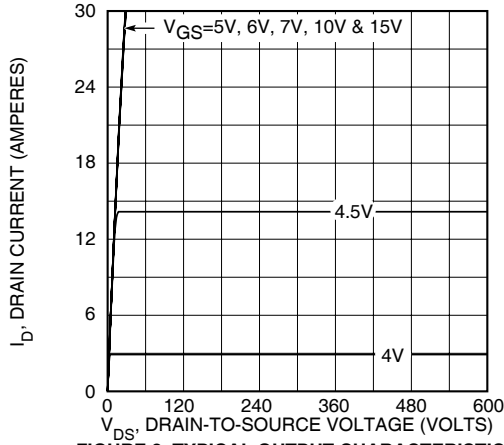

FIGURE 2, TYPICAL OUTPUT CHARACTERISTICS

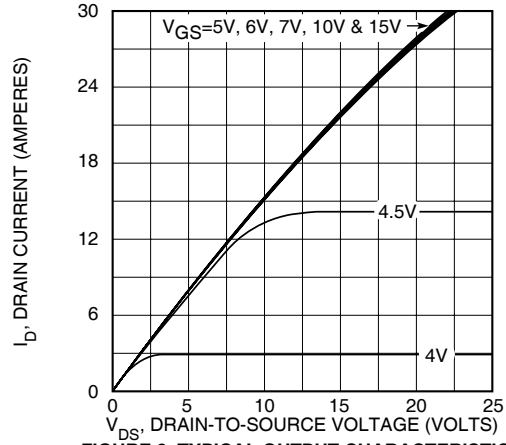

FIGURE 3, TYPICAL OUTPUT CHARACTERISTICS

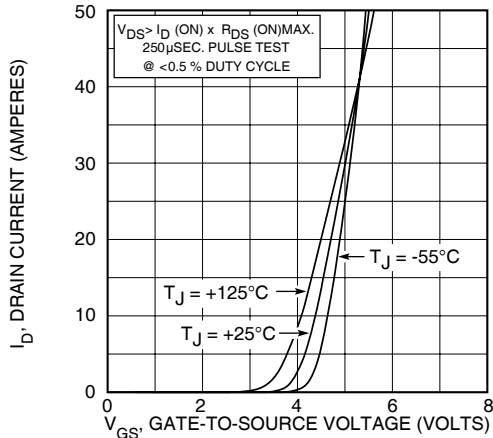

FIGURE 4, TYPICAL TRANSFER CHARACTERISTICS

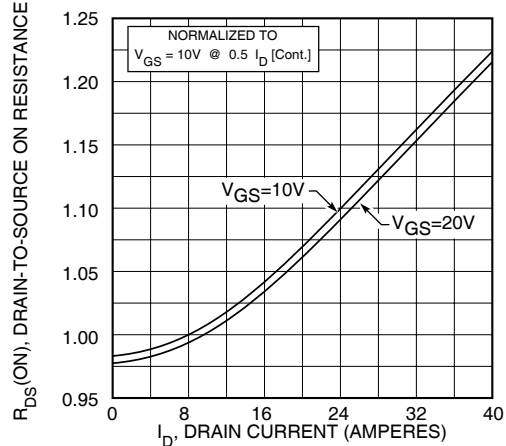

FIGURE 5,  $R_{DS(ON)}$  vs DRAIN CURRENT

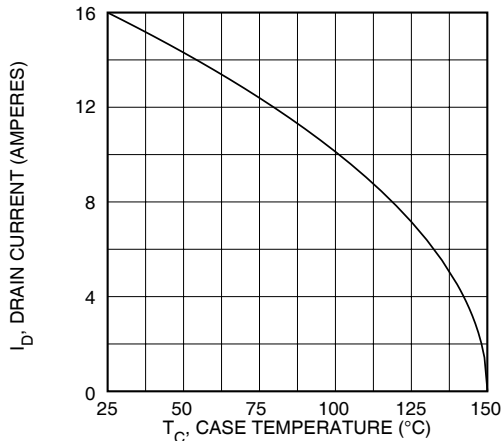

FIGURE 6, MAXIMUM DRAIN CURRENT vs CASE TEMPERATURE

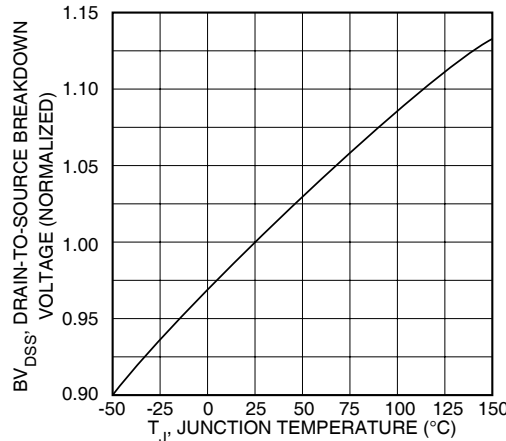

FIGURE 7, BREAKDOWN VOLTAGE vs TEMPERATURE

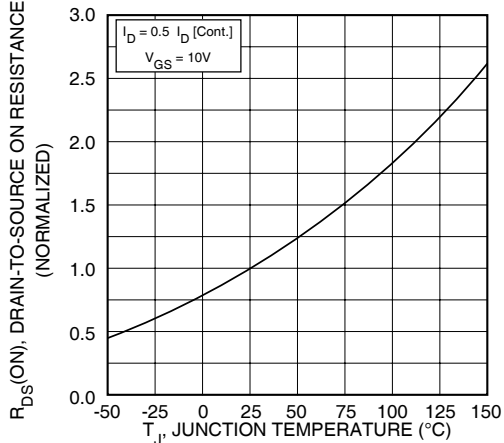

FIGURE 8, ON-RESISTANCE vs. TEMPERATURE

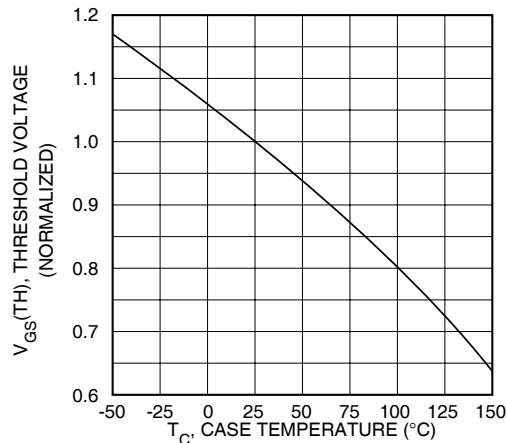

FIGURE 9, THRESHOLD VOLTAGE vs TEMPERATURE

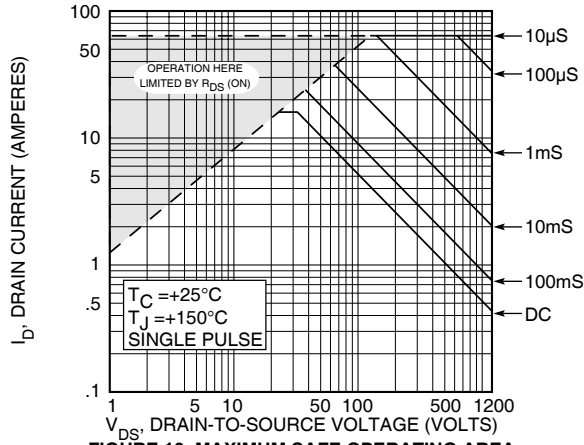

FIGURE 10, MAXIMUM SAFE OPERATING AREA

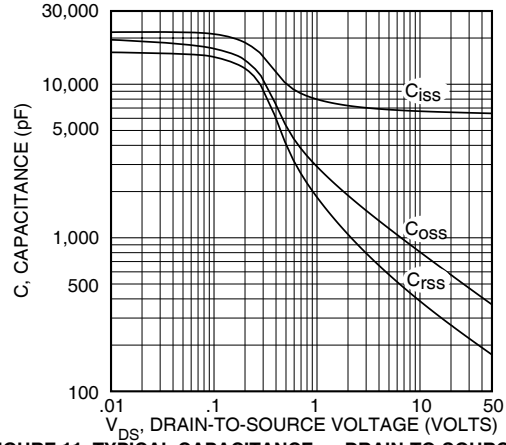

FIGURE 11, TYPICAL CAPACITANCE vs DRAIN-TO-SOURCE VOLTAGE

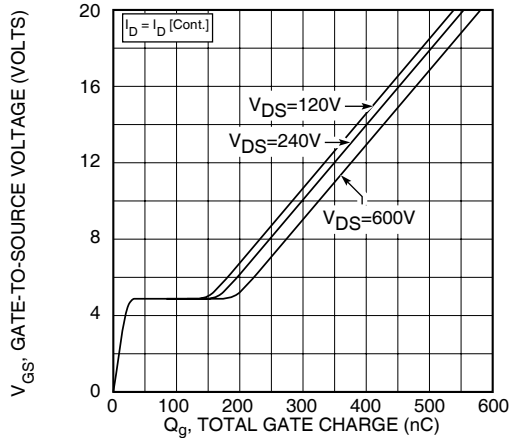

FIGURE 12, GATE CHARGES vs GATE-TO-SOURCE VOLTAGE

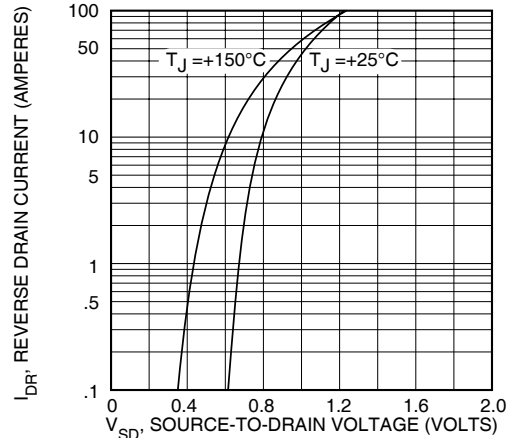
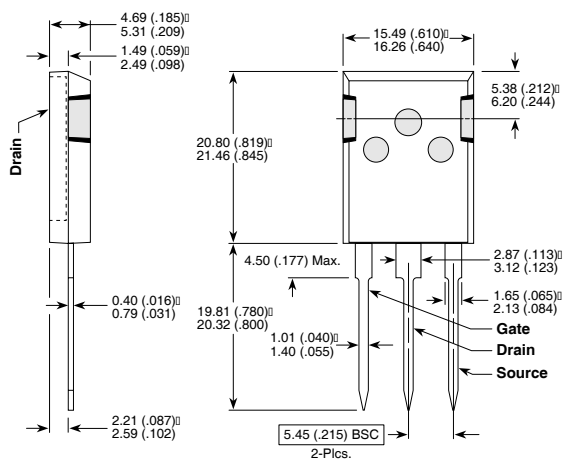

FIGURE 13, TYPICAL SOURCE-DRAIN DIODE FORWARD VOLTAGE

T-MAX™ (B2) Package Outline



These dimensions are equal to the TO-247 without the mounting hole.  
Dimensions in Millimeters and (Inches)

TO-264 (L) Package Outline

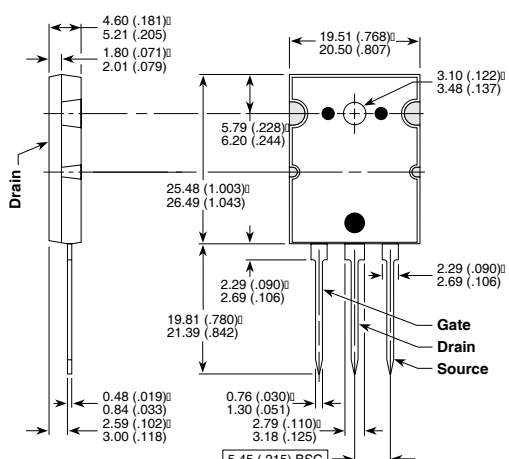

Dimensions in Millimeters and (Inches)