

General purpose transistors (dual transistors)

EMX1 / UMX1N / IMX1

●Features

- 1) Two 2SC2412K chips in a EMT or UMT or SMT package.
- 2) Mounting possible with EMT3 or UMT3 or SMT3 automatic mounting machines.
- 3) Transistor elements are independent, eliminating interference.
- 4) Mounting cost and area can be cut in half.

●Structure

Epitaxial planar type
NPN silicon transistor

●Equivalent circuit

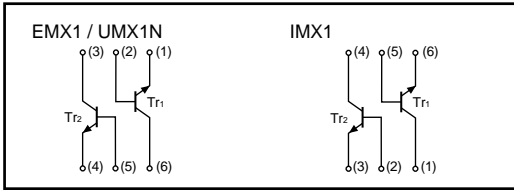

The following characteristics apply to both Tr1 and Tr2.

●Absolute maximum ratings (Ta = 25°C)

Parameter	Symbol	Limits	Unit
Collector-base voltage	V _{CB0}	60	V
Collector-emitter voltage	V _{CE0}	50	V
Emitter-base voltage	V _{EB0}	7	V
Collector current	I _c	150	mA
Power dissipation	EMX1, UMX1N	150 (TOTAL)	mW *1
	IMX1	300 (TOTAL)	mW *2
Junction temperature	T _j	150	°C
Storage temperature	T _{stg}	-55~+150	°C

*1 120mW per element must not be exceeded.
*2 200mW per element must not be exceeded.

●External dimensions (Units : mm)

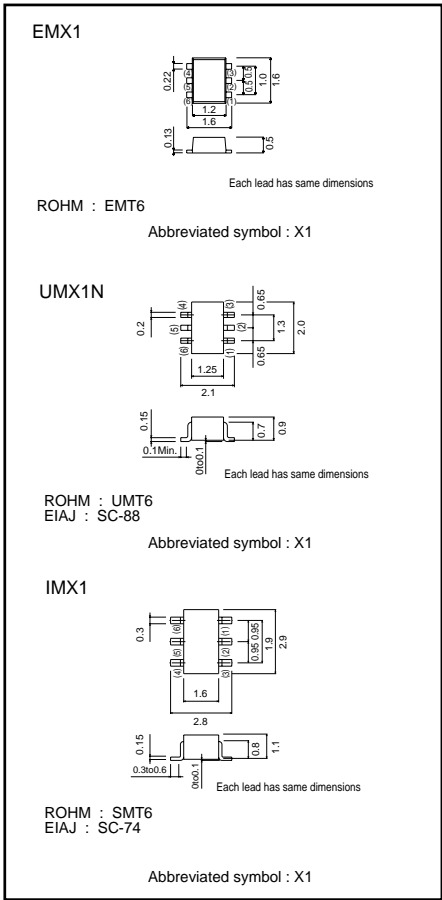

Transistors

●Electrical characteristics (Ta = 25°C)

Parameter	Symbol	Min.	Typ.	Max.	Unit	Conditions
Collector-base breakdown voltage	BV _{CB0}	60	—	—	V	I _c =50μA
Collector-emitter breakdown voltage	BV _{CE0}	50	—	—	V	I _c =1mA
Emitter-base breakdown voltage	BV _{EB0}	7	—	—	V	I _E =50μA
Collector cutoff current	I _{CBO}	—	—	0.1	μA	V _{CB} =60V
Emitter cutoff current	I _{EBO}	—	—	0.1	μA	V _{EB} =7V
Collector-emitter saturation voltage	V _{CE(sat)}	—	—	0.4	V	I _c /I _b =50mA/5mA
DC current transfer ratio	h _{FE}	120	—	560	—	V _{CE} =6V, I _c =1mA
Transition frequency	f _T	—	180	—	MHz	V _{CE} =12V, I _E =-2mA, f=100MHz *
Output capacitance	C _{ob}	—	2	3.5	PF	V _{CB} =12V, I _E =0A, f=1MHz

●Packaging specifications

Type	Package	Taping		
	Code	T2R	TR	T148
	Basic ordering unit (pieces)	8000	3000	3000
EMX1	○	—	—	—
UMX1N	—	○	—	—
IMX1	—	—	—	○

●Electrical characteristic curves

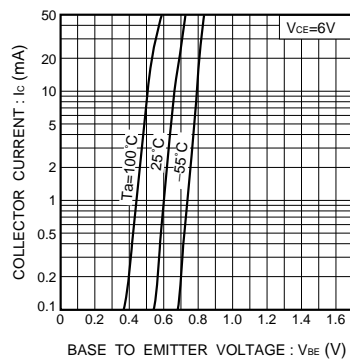

Fig.1 Grounded emitter propagation characteristics

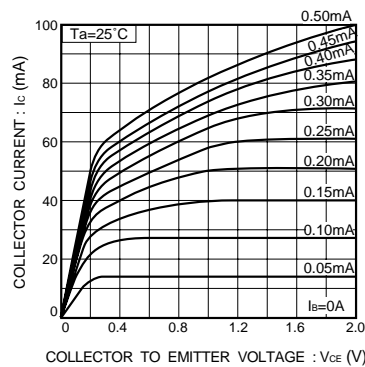

Fig.2 Grounded emitter output characteristics (I)

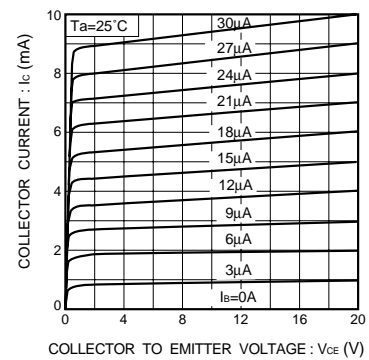

Fig.3 Grounded emitter output characteristics (II)

Transistors

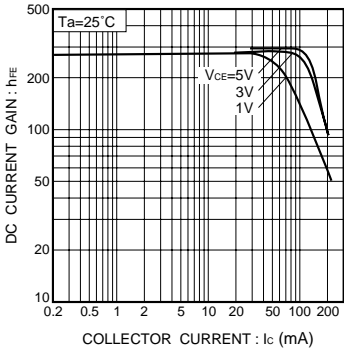

Fig.4 DC current gain vs. collector current (I)

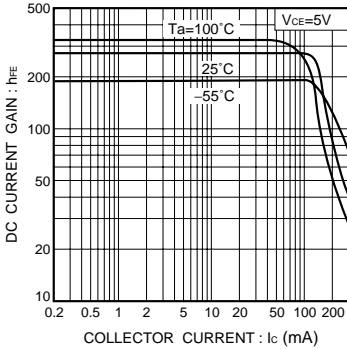

Fig.5 DC current gain vs. collector current (II)

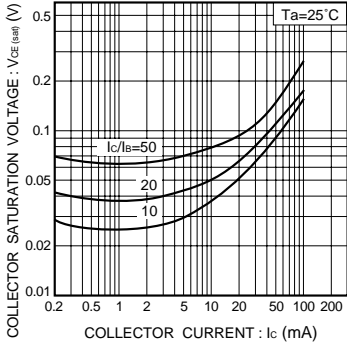

Fig.6 Collector-emitter saturation voltage vs. collector current

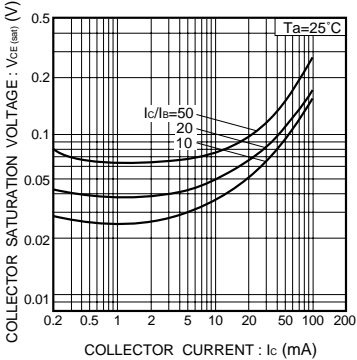

Fig.7 Collector-emitter saturation voltage vs. collector current (I)

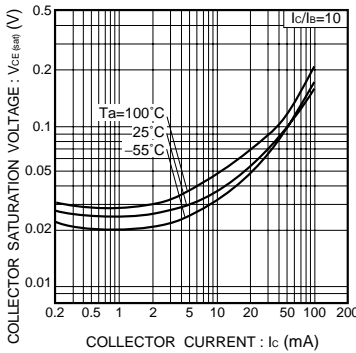

Fig.8 Collector-emitter saturation voltage vs. collector current (II)

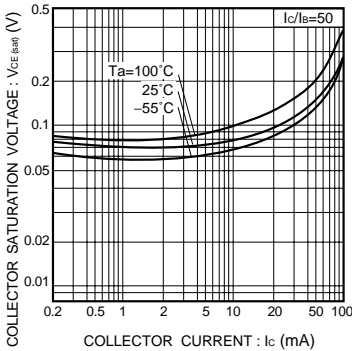

Fig.9 Collector-emitter saturation voltage vs. collector current (III)

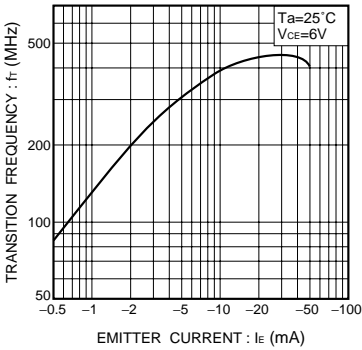

Fig.10 Gain bandwidth product vs. emitter current

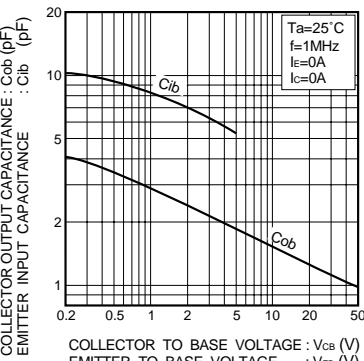

Fig.11 Collector output capacitance vs. collector-base voltage
Emitter input capacitance vs. emitter-base voltage

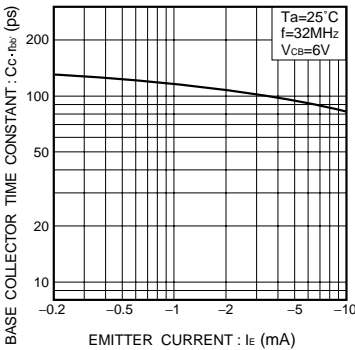

Fig.12 Base-collector time constant vs. emitter current