

## 54ACQ245 • 54ACTQ245

### Quiet Series Octal Bidirectional Transceiver with TRI-STATE® Inputs/Outputs

#### General Description

The 'ACQ/ACTQ245 contains eight non-inverting bidirectional buffers with TRI-STATE outputs and is intended for bus-oriented applications. Current sinking capability is 24 mA at both the A and B ports. The Transmit/Receive (T/R) input determines the direction of data flow through the bidirectional transceiver. Transmit (active-HIGH) enables data from A ports to B ports; Receive (active-LOW) enables data from B ports to A ports. The Output Enable input, when HIGH, disables both A and B ports by placing them in a HIGH Z condition.

The 'ACQ/ACTQ utilizes NSC Quiet Series technology to guarantee quiet output switching and improve dynamic threshold performance. FACT Quiet Series™ features GTO™ output control and undershoot corrector in addition to a split ground bus for superior performance.

#### Features

- $I_{CC}$  and  $I_{OZ}$  reduced by 50%
- Guaranteed simultaneous switching noise level and dynamic threshold performance
- Improved latch-up immunity
- TRI-STATE outputs drive bus lines or buffer memory address registers
- Outputs source/sink 24 mA
- Faster prop delays than the standard 'ACT245
- 4 kV minimum ESD immunity ('ACQ)
- Standard Military Drawing (SMD)
  - 'ACTQ245: 5962-92187
  - 'ACQ245: 5962-92177

#### Logic Symbols

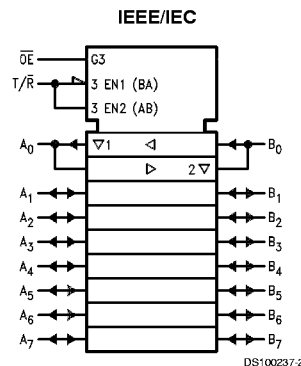
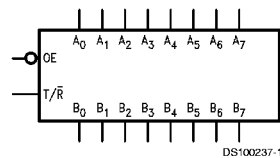

Pin Names	Description
OE	Output Enable Input
T/R	Transmit/Receive Input
A <sub>0</sub> -A <sub>7</sub>	Side A TRI-STATE Inputs or TRI-STATE Outputs
B <sub>0</sub> -B <sub>7</sub>	Side B TRI-STATE Inputs or TRI-STATE Outputs

GTO™ is a trademark of National Semiconductor Corporation.  
 TRI-STATE® is a registered trademark of National Semiconductor Corporation.  
 FACT® is a registered trademark of Fairchild Semiconductor Corporation.  
 FACT Quiet Series™ is a trademark of Fairchild Semiconductor Corporation.

**54ACQ245 • 54ACTQ245 Quiet Series Octal Bidirectional Transceiver with TRI-STATE Inputs/Outputs**

## Connection Diagrams

**Pin Assignment for  
DIP and Flatpak**

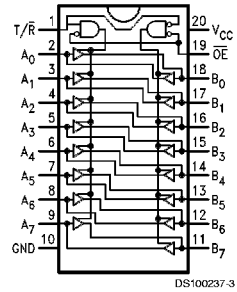

**Pin Assignment  
for LCC**

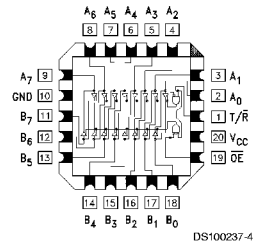

## Truth Table

Inputs		Outputs
OE	T/R	
L	L	Bus B Data to Bus A
L	H	Bus A Data to Bus B
H	X	HIGH-Z State

H = HIGH Voltage Level  
L = LOW Voltage Level  
X = Immaterial

## Absolute Maximum Ratings (Note 1)

If Military/Aerospace specified devices are required, please contact the National Semiconductor Sales Office/Distributors for availability and specifications.

Supply Voltage ( $V_{CC}$ )	-0.5V to +7.0V
DC Input Diode Current ( $I_{IK}$ )	
$V_I = -0.5V$	-20 mA
$V_I = V_{CC} + 0.5V$	+20 mA
DC Input Voltage ( $V_I$ )	-0.5V to $V_{CC} + 0.5V$
DC Output Diode Current ( $I_{OK}$ )	
$V_O = -0.5V$	-20 mA
$V_O = V_{CC} + 0.5V$	+20 mA
DC Output Voltage ( $V_O$ )	-0.5V to $V_{CC} + 0.5V$
DC Output Source	
or Sink Current ( $I_O$ )	$\pm 50$ mA
DC $V_{CC}$ or Ground Current	
per Output Pin ( $I_{CC}$ or $I_{GND}$ )	$\pm 50$ mA
Storage Temperature ( $T_{STG}$ )	-65°C to +150°C
DC Latch-Up Source or	
Sink Current	$\pm 300$ mA
Junction Temperature ( $T_J$ )	
CDIP	175°C

## Recommended Operating Conditions

Supply Voltage ( $V_{CC}$ )	
'ACQ	2.0V to 6.0V
'ACTQ	4.5V to 5.5V
Input Voltage ( $V_I$ )	0V to $V_{CC}$
Output Voltage ( $V_O$ )	0V to $V_{CC}$
Operating Temperature ( $T_A$ )	
54ACQ/ACTQ	-55°C to +125°C
Minimum Input Edge Rate $\Delta V/\Delta t$	
'ACQ Devices	
$V_{IN}$ from 30% to 70% of $V_{CC}$	
$V_{CC}$ @ 3.0V, 4.5V, 5.5V	125 mV/ns
Minimum Input Edge Rate $\Delta V/\Delta t$	
'ACTQ Devices	
$V_{IN}$ from 0.8V to 2.0V	
$V_{CC}$ @ 4.5V, 5.5V	125 mV/ns

**Note 1:** Absolute maximum ratings are those values beyond which damage to the device may occur. The databook specifications should be met, without exception, to ensure that the system design is reliable over its power supply, temperature, and output/input loading variables. National does not recommend operation of FACT® circuits outside databook specifications.

## DC Characteristics for 'ACQ Family Devices

Symbol	Parameter	$V_{CC}$ (V)	54ACQ		Units	Conditions
			$T_A =$ -55°C to +125°C			
			Guaranteed Limits			
$V_{IH}$	Minimum High Level Input Voltage	3.0	2.1	V	$V_{OUT} = 0.1V$ or $V_{CC} - 0.1V$	
		4.5	3.15			
		5.5	3.85			
$V_{IL}$	Maximum Low Level Input Voltage	3.0	0.9	V	$V_{OUT} = 0.1V$ or $V_{CC} - 0.1V$	
		4.5	1.35			
		5.5	1.65			
$V_{OH}$	Minimum High Level Output Voltage	3.0	2.9	V	$I_{OUT} = -50 \mu A$	
		4.5	4.4			
		5.5	5.4			
			3.0	2.4	V	(Note 2) $V_{IN} = V_{IL}$ or $V_{IH}$ -12 mA $I_{OH}$ -24 mA -24 mA
			4.5	3.7		
			5.5	4.7		
$V_{OL}$	Maximum Low Level Output Voltage	3.0	0.1	V	$I_{OUT} = 50 \mu A$	
		4.5	0.1			
		5.5	0.1			
			3.0	0.50	V	(Note 2) $V_{IN} = V_{IL}$ or $V_{IH}$ 12 mA $I_{OL}$ 24 mA 24 mA
			4.5	0.50		
			5.5	0.50		
$I_{IN}$	Maximum Input Leakage Current	5.5	$\pm 1.0$	$\mu A$	$V_I = V_{CC}, GND$ (Note 4)	

### DC Characteristics for 'ACQ Family Devices (Continued)

Symbol	Parameter	V <sub>CC</sub> (V)	54ACQ	Units	Conditions
			T <sub>A</sub> = -55°C to +125°C		
			Guaranteed Limits		
I <sub>OLD</sub>	(Note 3) Minimum Dynamic Output Current	5.5	50	mA	V <sub>OLD</sub> = 1.65V Max
I <sub>OHD</sub>		5.5	-50	mA	V <sub>OHD</sub> = 3.85V Min
I <sub>CC</sub>	Maximum Quiescent Supply Current	5.5	80.0	μA	V <sub>IN</sub> = V <sub>CC</sub> or GND (Note 4)
I <sub>OZT</sub>	Maximum I/O Leakage Current	5.5	±5.5	μA	V <sub>I(OE)</sub> = V <sub>IL</sub> , V <sub>IH</sub> V <sub>I</sub> = V <sub>CC</sub> , GND V <sub>O</sub> = V <sub>CC</sub> , GND
V <sub>OLP</sub>	Quiet Output Maximum Dynamic V <sub>OL</sub>	5.0	1.5	V	(Note 5)
V <sub>OLV</sub>	Quiet Output Minimum Dynamic V <sub>OL</sub>	5.0	-1.2	V	(Note 5)

**Note 2:** All outputs loaded; thresholds on input associated with output under test.

**Note 3:** Maximum test duration 2.0 ms, one output loaded at a time.

**Note 4:** I<sub>IN</sub> and I<sub>CC</sub> @ 3.0V are guaranteed to be less than or equal to the respective limit @ 5.5V V<sub>CC</sub>.

**Note 5:** Max number of outputs defined as (n). Data Inputs are driven 0V to 5V; one output @ GND.

### DC Characteristics for 'ACTQ Family Devices

Symbol	Parameter	V <sub>CC</sub> (V)	54ACTQ	Units	Conditions
			T <sub>A</sub> = -55°C to +125°C		
			Guaranteed Limits		
V <sub>IH</sub>	Minimum High Level Input Voltage	4.5	2.0	V	V <sub>OUT</sub> = 0.1V or V <sub>CC</sub> - 0.1V
		5.5	2.0		
V <sub>IL</sub>	Maximum Low Level Input Voltage	4.5	0.8	V	V <sub>OUT</sub> = 0.1V or V <sub>CC</sub> - 0.1V
		5.5	0.8		
V <sub>OH</sub>	Minimum High Level Output Voltage	4.5	4.4	V	I <sub>OUT</sub> = -50 μA
		5.5	5.4		
		4.5	3.70	V	(Note 6) V <sub>IN</sub> = V <sub>IL</sub> or V <sub>IH</sub> I <sub>OH</sub> -24 mA
		5.5	4.70		
V <sub>OL</sub>	Maximum Low Level Output Voltage	4.5	0.1	V	I <sub>OUT</sub> = 50 μA
		5.5	0.1		
		4.5	0.50	V	(Note 6) V <sub>IN</sub> = V <sub>IL</sub> or V <sub>IH</sub> I <sub>OL</sub> 24 mA
		5.5	0.50		
I <sub>IN</sub>	Maximum Input Leakage Current	5.5	±1.0	μA	V <sub>I</sub> = V <sub>CC</sub> , GND
I <sub>OZT</sub>	Maximum TRI-STATE Leakage Current	5.5	±5.0	μA	V <sub>I</sub> = V <sub>IL</sub> , V <sub>IH</sub> V <sub>O</sub> = V <sub>CC</sub> , GND

## DC Characteristics for 'ACTQ Family Devices (Continued)

Symbol	Parameter	V <sub>CC</sub> (V)	54ACTQ		Units	Conditions
			T <sub>A</sub> = -55°C to +125°C			
			Guaranteed Limits			
I <sub>CC</sub> T	Maximum I <sub>CC</sub> /Input	5.5	1.6		mA	V <sub>I</sub> = V <sub>CC</sub> - 2.1V
I <sub>OLD</sub>	(Note 7) Minimum Dynamic Output Current	5.5	50		mA	V <sub>OLD</sub> = 1.65V Max
I <sub>OHD</sub>		5.5	-50		mA	V <sub>OHD</sub> = 3.85V Min
I <sub>CC</sub>	Maximum Quiescent Supply Current	5.5	80.0		μA	V <sub>IN</sub> = V <sub>CC</sub> or GND
V <sub>OLP</sub>	Quiet Output Maximum Dynamic V <sub>OL</sub>	5.0	1.65		V	(Note 8)
V <sub>OLV</sub>	Quiet Output Minimum Dynamic V <sub>OL</sub>	5.0	-1.2		V	(Note 8)

**Note 6:** All outputs loaded; thresholds on input associated with output under test.

**Note 7:** Maximum test duration 2.0 ms, one output loaded at a time.

**Note 8:** Max number of outputs defined as (n). n-1 Data Inputs are driven 0V to 3V; one output @ GND.

## AC Electrical Characteristics for 'ACQ Devices

Symbol	Parameter	V <sub>CC</sub> (V) (Note 9)	54ACQ		Units	Fig. No.
			T <sub>A</sub> = -55°C to +125°C C <sub>L</sub> = 50 pF			
			Min	Max		
t <sub>PHL</sub> , t <sub>PLH</sub>	Propagation Delay Data to Output	3.0	1.5	11.5	ns	
		4.5	1.5	10.0		
t <sub>PZL</sub> , t <sub>PZH</sub>	Output Enable Time	3.0	1.5	13.0	ns	
		4.5	1.5	10.0		
t <sub>PHZ</sub> , t <sub>PLZ</sub>	Output Disable Time	3.0	1.5	13.0	ns	
		4.5	1.5	10.0		

**Note 9:** Voltage Range 5.0 is 5.0V ±0.5V

Voltage Range 3.3 is 3.3V ±0.3V

## AC Electrical Characteristics for 'ACTQ Devices

Symbol	Parameter	V <sub>CC</sub> (V) (Note 10)	54ACTQ		Units	Fig. No.
			T <sub>A</sub> = -55°C to +125°C C <sub>L</sub> = 50 pF			
			Min	Max		
t <sub>PHL</sub> , t <sub>PLH</sub>	Propagation Delay Data to Output	5.0	1.5	9.0	ns	
t <sub>PZL</sub> , t <sub>PZH</sub>	Output Enable Time	5.0	1.5	12.0	ns	
t <sub>PHZ</sub> , t <sub>PLZ</sub>	Output Disable Time	5.0	1.5	11.5	ns	

Note 10: Voltage Range 5.0 is 5.0V ±0.5V

## Capacitance

Symbol	Parameter	Typ	Units	Conditions
C <sub>IN</sub>	Input Capacitance	4.5	pF	V <sub>CC</sub> = OPEN
C <sub>I/O</sub>	Input/Output Capacitance	15	pF	V <sub>CC</sub> = 5.0V
C <sub>PD</sub>	Power Dissipation Capacitance	80.0	pF	V <sub>CC</sub> = 5.0V

**Physical Dimensions** inches (millimeters) unless otherwise noted

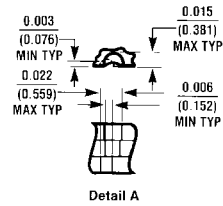
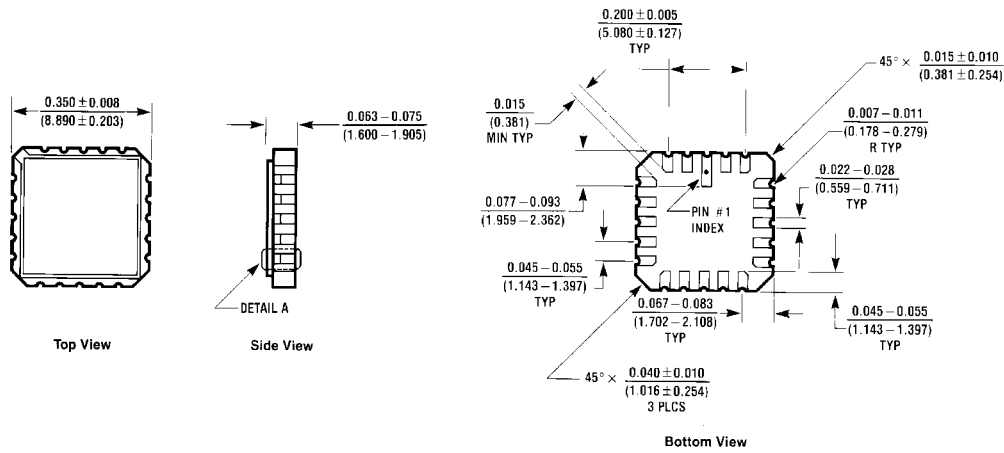

E20A (REV D)

**20-Terminal Ceramic Leadless Chip Carrier (L)  
NS Package Number E20A**

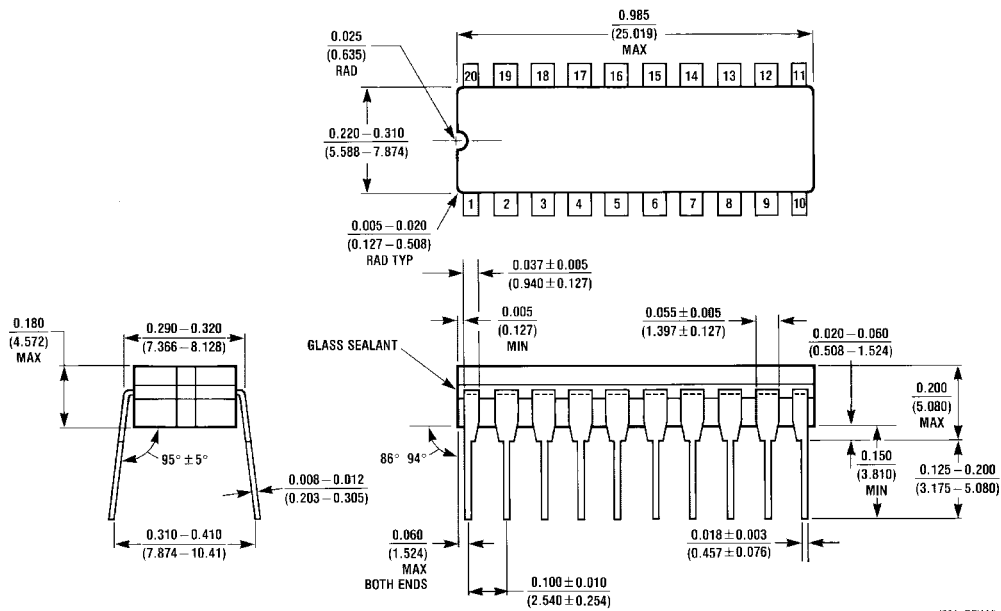

J20A (REV M)

**20-Lead Ceramic Dual-In-Line Package (D)  
NS Package Number J20A**