

Darlington Amplifier Transistors

- We declare that the material of product compliance with RoHS requirements.

ORDERING INFORMATION

Device	Marking	Shipping
LMBTA13LT1G S-LMBTA13LT1G	1M	3000/Tape & Reel
LMBTA14LT1G S-LMBTA14LT1G	1N	3000/Tape & Reel
LMBTA13LT3G S-LMBTA13LT3G	1M	10000/Tape & Reel
LMBTA14LT3G S-LMBTA14LT3G	1N	10000/Tape & Reel

LMBTA13LT1G
LMBTA14LT1G
S-LMBTA13LT1G
S-LMBTA14LT1G

MAXIMUM RATINGS

Rating	Symbol	Value	Unit
Collector–Emitter Voltage	V_{CES}	30	Vdc
Collector–Base Voltage	V_{CBO}	30	Vdc
Emitter–Base Voltage	V_{EBO}	10	Vdc
Collector Current — Continuous	I_C	300	mAdc

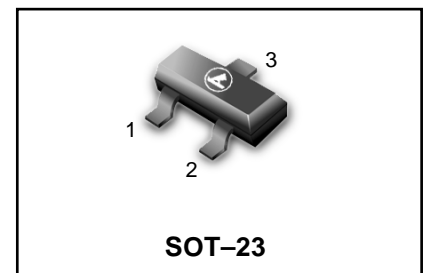

THERMAL CHARACTERISTICS

Characteristic	Symbol	Max	Unit
Total Device Dissipation FR–5 Board, (1) $T_A = 25^\circ\text{C}$	P_D	225	mW
Derate above 25°C		1.8	mW/ $^\circ\text{C}$
Thermal Resistance, Junction to Ambient	$R_{\theta JA}$	556	$^\circ\text{C}/\text{W}$
Total Device Dissipation Alumina Substrate, (2) $T_A = 25^\circ\text{C}$	P_D	300	mW
Derate above 25°C		2.4	mW/ $^\circ\text{C}$
Thermal Resistance, Junction to Ambient	$R_{\theta JA}$	417	$^\circ\text{C}/\text{W}$
Junction and Storage Temperature	T_J, T_{stg}	-55 to +150	$^\circ\text{C}$

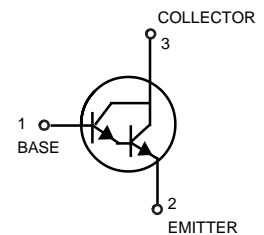

DEVICE MARKING

(S-)LMBTA13LT1G = 1M; (S-)LMBTA14LT1G = 1N;

ELECTRICAL CHARACTERISTICS ($T_A = 25^\circ\text{C}$ unless otherwise noted.)

Characteristic	Symbol	Min	Max	Unit
----------------	--------	-----	-----	------

OFF CHARACTERISTICS

Collector–Emitter Breakdown Voltage ($I_C = 100 \mu\text{Adc}, V_{BE} = 0$)	$V_{(BR)CEO}$	30	—	Vdc
Collector Cutoff Current ($V_{CB} = 30\text{Vdc}, I_E = 0$)	I_{CBO}	—	100	nAdc
Emitter Cutoff Current ($V_{EB} = 10\text{Vdc}, I_C = 0$)	I_{EBO}	—	100	nAdc

1. FR–5 = 1.0 x 0.75 x 0.062 in.

2. Alumina = 0.4 x 0.3 x 0.024 in. 99.5% alumina.

LMBTA13LT1G LMBTA14LT1G
S-LMBTA13LT1G S-LMBTA14LT1G

ELECTRICAL CHARACTERISTICS ($T_A = 25^\circ\text{C}$ unless otherwise noted) (Continued)

Characteristic	Symbol	Min	Max	Unit
ON CHARACTERISTICS (3)				
DC Current Gain ($I_C = 10 \text{ mAdc}, V_{CE} = 5.0 \text{ Vdc}$)	h_{FE}	5,000	—	—
	LMBTA13	5,000	—	—
	LMBTA14	10,000	—	—
($I_C = 100\text{mAdc}, V_{CE} = 5.0\text{Vdc}$)	LMBTA13	10,000	—	—
	LMBTA14	20,000	—	—
Collector–Emitter Saturation Voltage ($I_C = 100 \text{ mAdc}, I_B = 0.1 \text{ mAdc}$)	$V_{CE(sat)}$	—	1.5	Vdc
Base–Emitter On Voltage ($I_C = 100\text{mAdc}, V_{CE} = 5.0\text{Vdc}$)	V_{BE}	—	2.0	Vdc

SMALL–SIGNAL CHARACTERISTICS

Current – Gain–Bandwidth Product(4) ($V_{CE} = 5.0 \text{ Vdc}, I_C = 10\text{mAdc}, f = 100 \text{ MHz}$)	f_T	125	—	MHz
---	-------	-----	---	-----

3. Pulse Test: Pulse Width $\leq 300 \mu\text{s}$, Duty Cycle $\leq 2.0\%$.

4. $f_T = |h_{fe}| * f_{test}$.

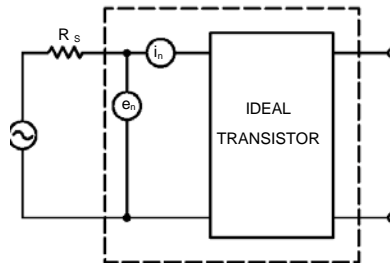

Figure 1. Transistor Noise Model

LMBTA13LT1G LMBTA14LT1G
S-LMBTA13LT1G S-LMBTA14LT1G

NOISE CHARACTERISTICS

($V_{CE} = 5.0 \text{ Vdc}$, $T_A = 25^\circ\text{C}$)

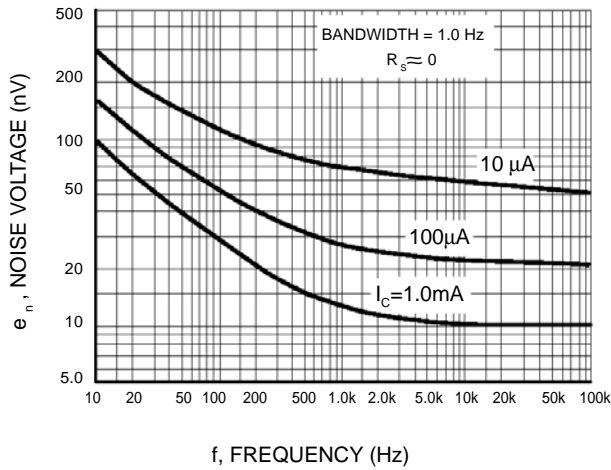

Figure 2. Noise Voltage

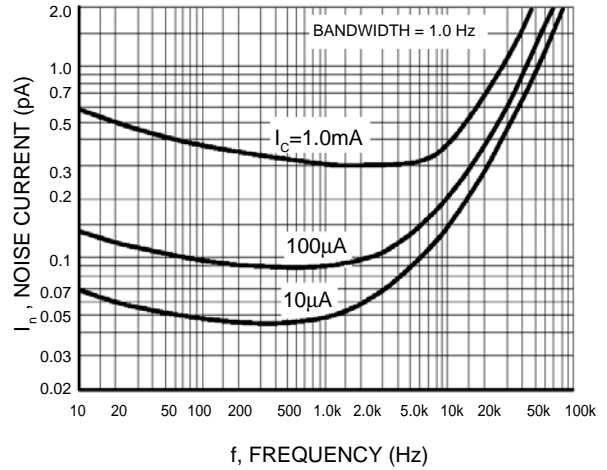

Figure 3. Noise Current

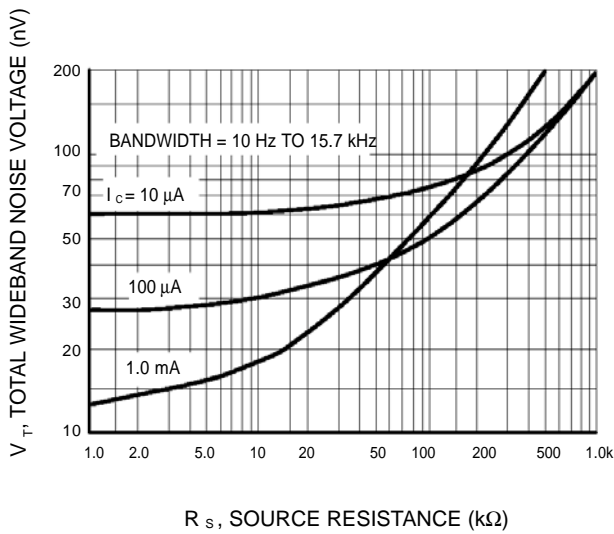

Figure 4. Total Wideband Noise Voltage

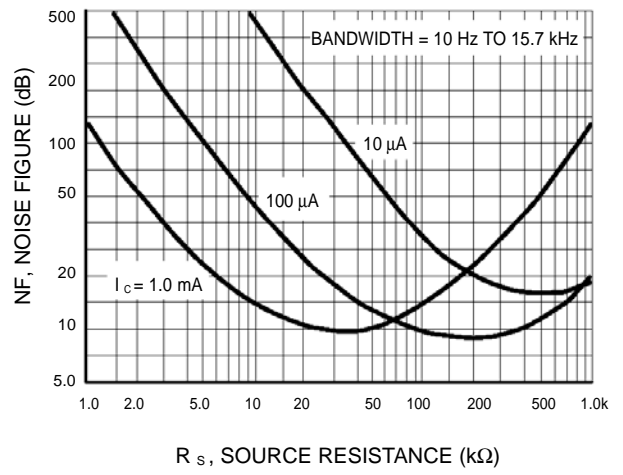
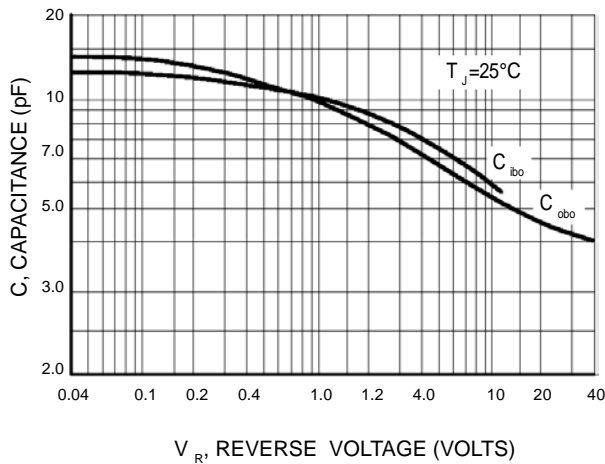

Figure 5. Wideband Noise Figure

LMBTA13LT1G LMBTA14LT1G
S-LMBTA13LT1G S-LMBTA14LT1G

SMALL-SIGNAL CHARACTERISTICS



V_{R1} , REVERSE VOLTAGE (VOLTS)
Figure 6. Capacitance

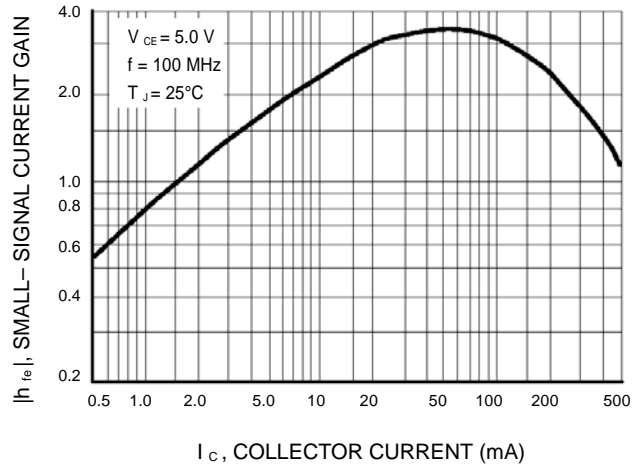

I_C , COLLECTOR CURRENT (mA)
Figure 7. High Frequency Current Gain

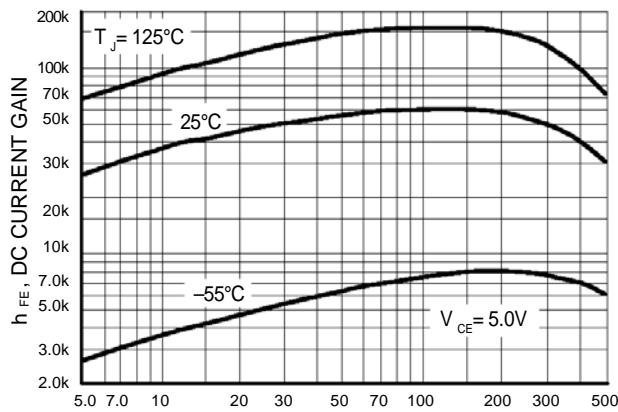

I_C , COLLECTOR CURRENT (mA)
Figure 8. DC Current Gain

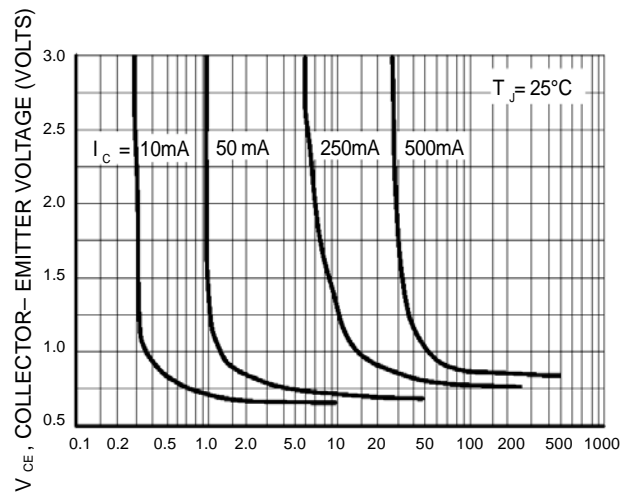

I_B , BASE CURRENT (μ A)
Figure 9. Collector Saturation Region

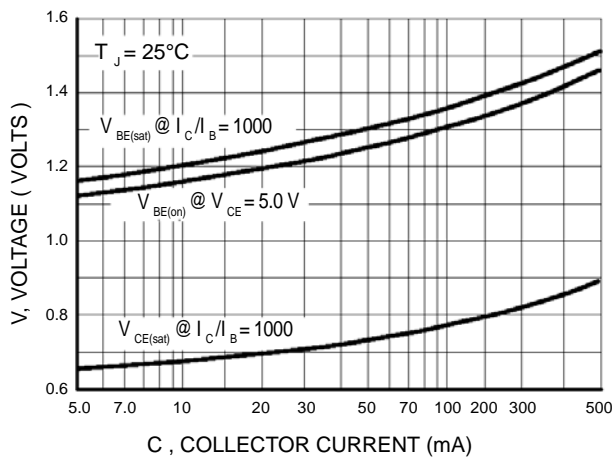

I_C , COLLECTOR CURRENT (mA)
Figure 17. "ON" Voltages

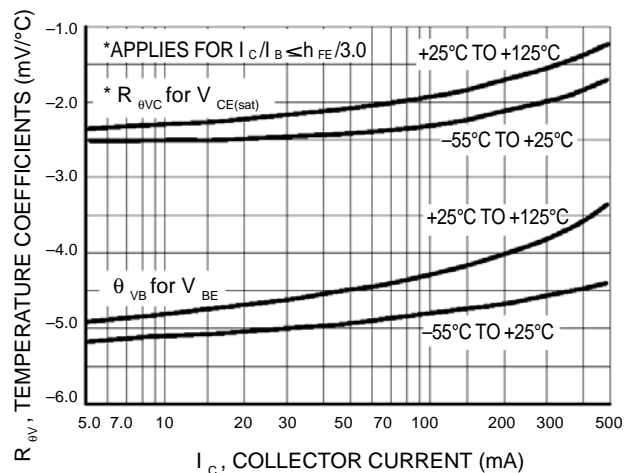

I_C , COLLECTOR CURRENT (mA)
Figure 18. Temperature Coefficients

LMBTA13LT1G LMBTA14LT1G
S-LMBTA13LT1G S-LMBTA14LT1G

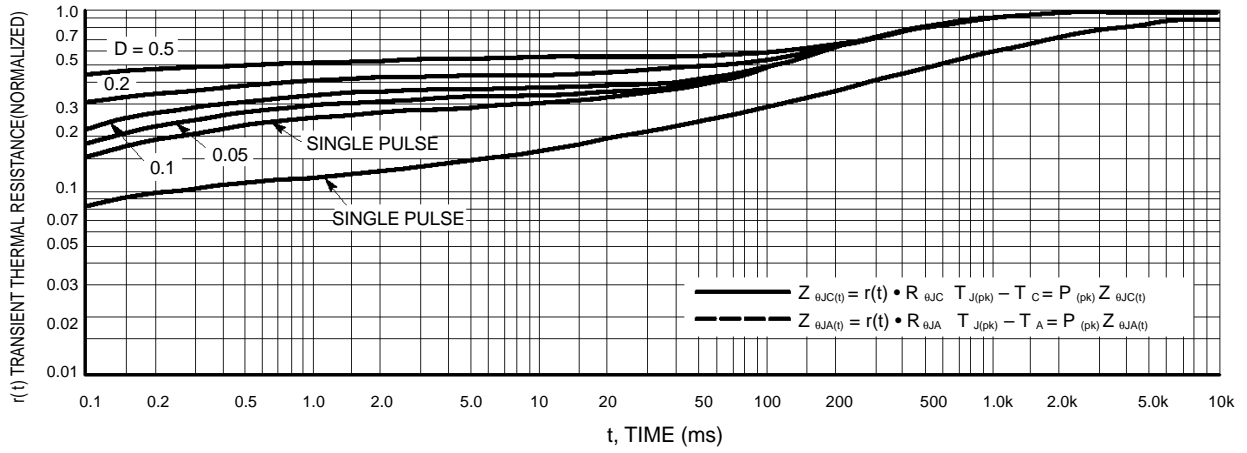

Figure 12. Thermal Response

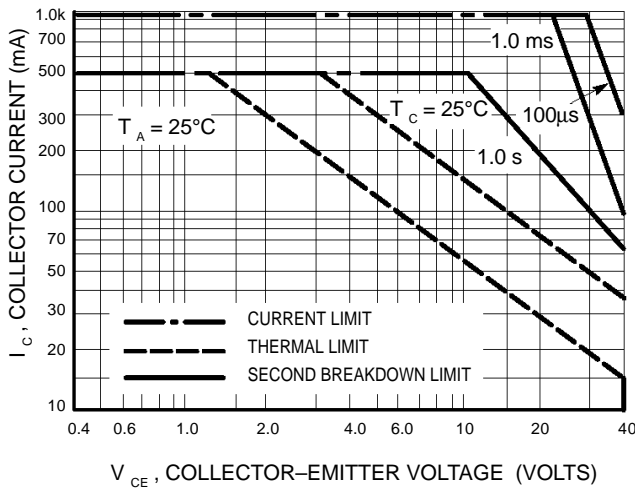
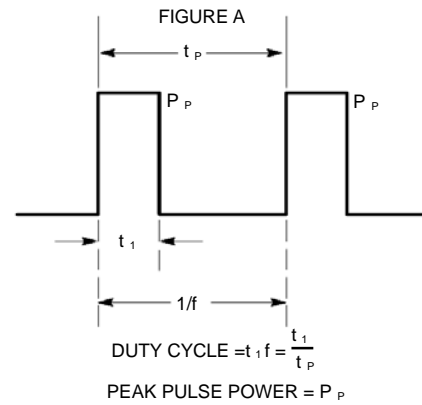

Figure 13. Active Region Safe Operating Area



Design Note: Use of Transient Thermal Resistance Data

LMBTA13LT1G LMBTA14LT1G
S-LMBTA13LT1G S-LMBTA14LT1G

SOT-23

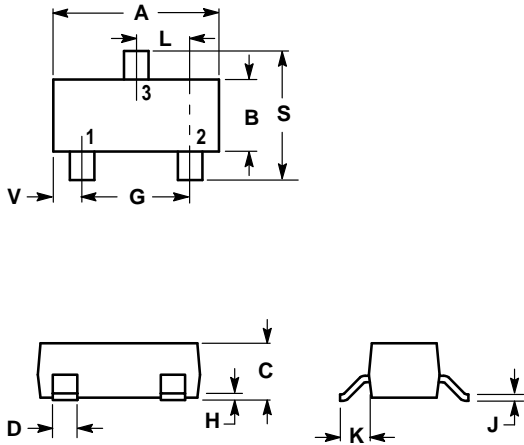

NOTES:

1. DIMENSIONING AND TOLERANCING PER ANSI Y14.5M, 1982.
2. CONTROLLING DIMENSION: INCH.

DIM	INCHES		MILLIMETERS	
	MIN	MAX	MIN	MAX
A	0.1102	0.1197	2.80	3.04
B	0.0472	0.0551	1.20	1.40
C	0.0350	0.0440	0.89	1.11
D	0.0150	0.0200	0.37	0.50
G	0.0701	0.0807	1.78	2.04
H	0.0005	0.0040	0.013	0.100
J	0.0034	0.0070	0.085	0.177
K	0.0140	0.0285	0.35	0.69
L	0.0350	0.0401	0.89	1.02
S	0.0830	0.1039	2.10	2.64
V	0.0177	0.0236	0.45	0.60

- PIN 1. BASE
 2. EMITTER
 3. COLLECTOR

