

National Semiconductor is now part of  
Texas Instruments.

Search <http://www.ti.com/> for the latest technical  
information and details on our current products and services.

# LM2930

## 3-Terminal Positive Regulator

### General Description

The LM2930 3-terminal positive regulator features an ability to source 150 mA of output current with an input-output differential of 0.6V or less. Efficient use of low input voltages obtained, for example, from an automotive battery during cold crank conditions, allows 5V circuitry to be properly powered with supply voltages as low as 5.6V. Familiar regulator features such as current limit and thermal overload protection are also provided.

Designed originally for automotive applications, the LM2930 and all regulated circuitry are protected from reverse battery installations or 2 battery jumps. During line transients, such as a load dump (40V) when the input voltage to the regulator can momentarily exceed the specified maximum operating voltage, the regulator will automatically shut down to protect both internal circuits and the load. The LM2930 cannot be harmed by temporary mirror-image insertion.

Fixed outputs of 5V and 8V are available in the plastic TO-220 and TO-263 power packages.

### Features

- Input-output differential less than 0.6V
- Output current in excess of 150 mA
- Reverse battery protection
- 40V load dump protection
- Internal short circuit current limit
- Internal thermal overload protection
- Mirror-image insertion protection
- P+ Product Enhancement tested

### Voltage Range

- |                |    |
|----------------|----|
| ■ LM2930T-5.0: | 5V |
| ■ LM2930T-8.0: | 8V |
| ■ LM2930S-5.0: | 5V |
| ■ LM2930S-8.0: | 8V |

### Connection Diagram

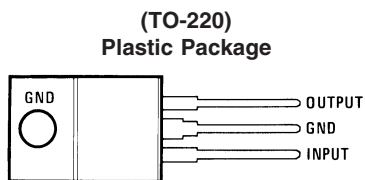

**Front View**  
Order Number LM2930T-5.0 or LM2930T-8.0  
See NS Package Number T03B

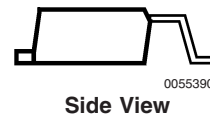

**Side View**  
Order Number LM2930S-5.0 or LM2930S-8.0  
See NS Package Number TS3B

### (TO-263) Plastic Surface-Mount Package

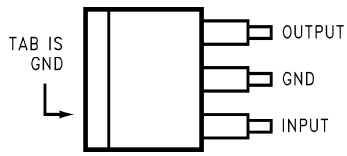

**Top View**

**Absolute Maximum Ratings** (Note 1)

If Military/Aerospace specified devices are required, please contact the National Semiconductor Sales Office/Distributors for availability and specifications.

Input Voltage	
Operating Range	26V
Overvoltage Protection	40V
Reverse Voltage (100 ms)	-12V

Reverse Voltage (DC)	-6V
Internal Power Dissipation (Note 2)	Internally Limited
Operating Temperature Range	-40°C to +85°C
Maximum Junction Temperature	125°C
Storage Temperature Range	-65°C to +150°C
Lead Temp. (Soldering, 10 seconds)	230°C

**Electrical Characteristics** (Note 3)

LM2930-5.0  $V_{IN}=14V$ ,  $I_O=150\text{ mA}$ ,  $T_J=25^\circ\text{C}$  (Note 6),  $C_2=10\text{ }\mu\text{F}$ , unless otherwise specified

Parameter	Conditions	Typ	Tested Limit (Note 4)	Design Limit (Note 5)	Unit
Output Voltage		5	5.3 4.7		$V_{MAX}$ $V_{MIN}$
	$6V \leq V_{IN} \leq 26V$ , $5\text{ mA} \leq I_O \leq 150\text{ mA}$ $-40^\circ\text{C} \leq T_J \leq 125^\circ\text{C}$			5.5 4.5	$V_{MAX}$ $V_{MIN}$
Line Regulation	$9V \leq V_{IN} \leq 16V$ , $I_O=5\text{ mA}$	7	25		$\text{mV}_{MAX}$
	$6V \leq V_{IN} \leq 26V$ , $I_O=5\text{ mA}$	30	80		$\text{mV}_{MAX}$
Load Regulation	$5\text{ mA} \leq I_O \leq 150\text{ mA}$	14	50		$\text{mV}_{MAX}$
Output Impedance	$100\text{ mA}_{DC}$ & $10\text{ mA}_{rms}$ , 100 Hz–10 kHz	200			$\text{m}\Omega$
Quiescent Current	$I_O=10\text{ mA}$	4	7		$\text{mA}_{MAX}$
	$I_O=150\text{ mA}$	18	40		$\text{mA}_{MAX}$
Output Noise Voltage	10 Hz–100 kHz	140			$\mu\text{V}_{rms}$
Long Term Stability		20			$\text{mV}/1000\text{ hr}$
Ripple Rejection	$f_O=120\text{ Hz}$	56			dB
Current Limit		400	700 150		$\text{mA}_{MAX}$ $\text{mA}_{MIN}$
Dropout Voltage	$I_O=150\text{ mA}$	0.32	0.6		$V_{MAX}$
Output Voltage Under Transient Conditions	$-12V \leq V_{IN} \leq 40V$ , $R_L=100\Omega$		5.5 -0.3		$V_{MAX}$ $V_{MIN}$

**Electrical Characteristics** (Note 3)

LM2930-8.0 ( $V_{IN}=14V$ ,  $I_O=150\text{ mA}$ ,  $T_J=25^\circ\text{C}$  (Note 6),  $C_2=10\text{ }\mu\text{F}$ , unless otherwise specified)

Parameter	Conditions	Typ	Tested Limit (Note 4)	Design Limit (Note 5)	Unit
Output Voltage		8	8.5 7.5		$V_{MAX}$ $V_{MIN}$
	$9.4V \leq V_{IN} \leq 26V$ , $5\text{ mA} \leq I_O \leq 150\text{ mA}$ , $-40^\circ\text{C} \leq T_J \leq 125^\circ\text{C}$			8.8 7.2	$V_{MAX}$ $V_{MIN}$
Line Regulation	$9.4V \leq V_{IN} \leq 16V$ , $I_O=5\text{ mA}$	12	50		$\text{mV}_{MAX}$
	$9.4V \leq V_{IN} \leq 26V$ , $I_O=5\text{ mA}$	50	100		$\text{mV}_{MAX}$
Load Regulation	$5\text{ mA} \leq I_O \leq 150\text{ mA}$	25	50		$\text{mV}_{MAX}$
Output Impedance	$100\text{ mA}_{DC}$ & $10\text{ mA}_{rms}$ , 100 Hz–10 kHz	300			$\text{m}\Omega$
Quiescent Current	$I_O=10\text{ mA}$	4	7		$\text{mA}_{MAX}$
	$I_O=150\text{ mA}$	18	40		$\text{mA}_{MAX}$
Output Noise Voltage	10 Hz–100 kHz	170			$\mu\text{V}_{rms}$
Long Term Stability		30			$\text{mV}/1000\text{ hr}$
Ripple Rejection	$f_O=120\text{ Hz}$	52			dB

# Electrical Characteristics (Note 3) (Continued)

LM2930-8.0 ( $V_{IN}=14V$ ,  $I_O=150\text{ mA}$ ,  $T_J=25^\circ\text{C}$  (Note 6),  $C_2=10\text{ }\mu\text{F}$ , unless otherwise specified)

Parameter	Conditions	Typ	Tested Limit (Note 4)	Design Limit (Note 5)	Unit
Current Limit		400	700 150		$\text{mA}_{MAX}$ $\text{mA}_{MIN}$
Dropout Voltage	$I_O=150\text{ mA}$	0.32	0.6		$V_{MAX}$
Output Voltage Under Transient Conditions	$-12V \leq V_{IN} \leq 40V$ , $R_L=100\Omega$		8.8 -0.3		$V_{MAX}$ $V_{MIN}$

**Note 1:** Absolute Maximum Ratings indicate limits beyond which damage to the device may occur. Operating ratings indicate conditions for which the device is functional, but do not guarantee specific performance limits. Electrical Characteristics state DC and AC electrical specifications under particular test conditions which guarantee specific performance limits. This assumes that the device is within the Operating Ratings. Specifications are not guaranteed for parameters where no limit is given, however, the typical value is a good indication of device performance.

**Note 2:** Thermal resistance without a heat sink for junction to case temperature is  $3^\circ\text{C/W}$  and for case to ambient temperature is  $50^\circ\text{C/W}$  for the TO-220,  $73^\circ\text{C/W}$  for the TO-263. If the TO-263 package is used, the thermal resistance can be reduced by increasing the P.C. board copper area thermally connected to the package. Using 0.5 square inches of copper area,  $\theta_{JA}$  is  $50^\circ\text{C/W}$ ; with 1 square inch of copper area,  $\theta_{JA}$  is  $37^\circ\text{C/W}$ ; and with 1.6 or more square inches of copper area,  $\theta_{JA}$  is  $32^\circ\text{C/W}$ .

**Note 3:** All characteristics are measured with a capacitor across the input of  $0.1\text{ }\mu\text{F}$  and a capacitor across the output of  $10\text{ }\mu\text{F}$ . All characteristics except noise voltage and ripple rejection ratio are measured using pulse techniques ( $t_{PW} \leq 10\text{ ms}$ , duty cycle  $\leq 5\%$ ). Output voltage changes due to changes in internal temperature must be taken into account separately.

**Note 4:** Guaranteed and 100% production tested.

**Note 5:** Guaranteed (but not 100% production tested) over the operating temperature and input current ranges. These limits are not used to calculate outgoing quality levels.

**Note 6:** To ensure constant junction temperature, low duty cycle pulse testing is used.

## Typical Application

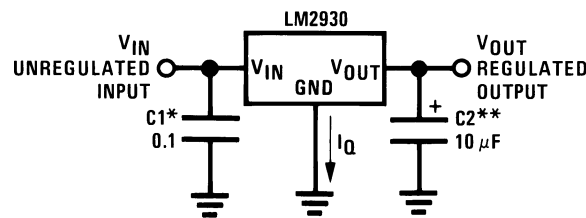

00553905

\*Required if regulator is located far from power supply filter.

\*\* $C_{OUT}$  must be at least  $10\text{ }\mu\text{F}$  to maintain stability. May be increased without bound to maintain regulation during transients. Locate as close as possible to the regulator. This capacitor must be rated over the same operating temperature range as the regulator. The equivalent series resistance (ESR) of this capacitor should be less than  $1\Omega$  over the expected operating temperature range.

## Typical Performance Characteristics

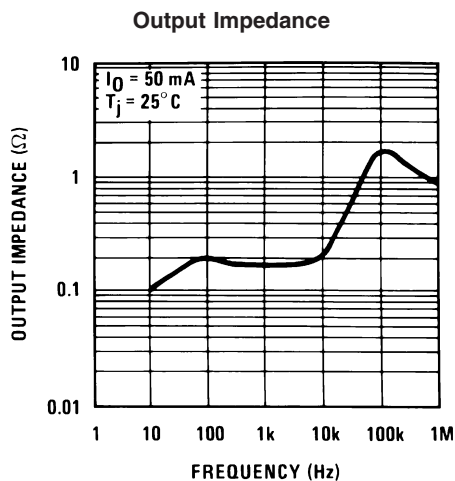

00553911

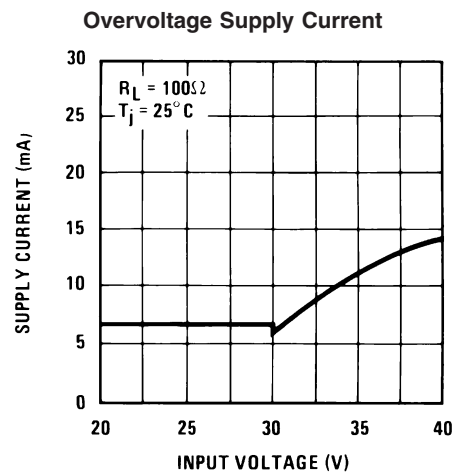

00553912

Typical Performance Characteristics (Continued)

Reverse Supply Current

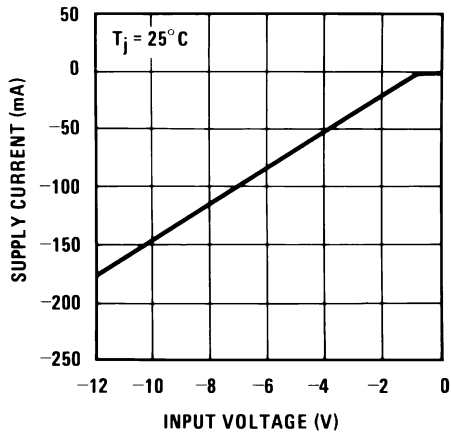

00553913

Output at Reverse Supply

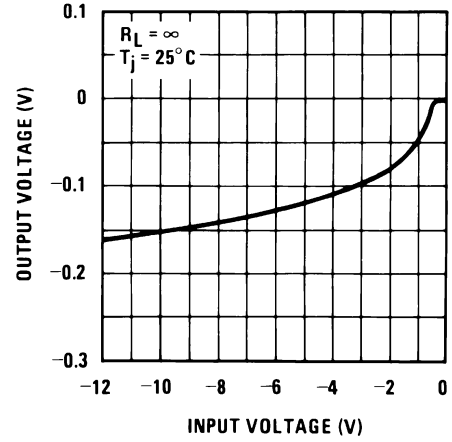

00553914

Output at Overvoltage

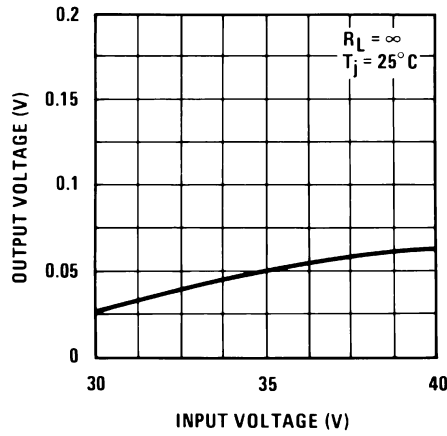

00553915

Output Voltage (Normalized to 1V at  $T_j=25^\circ\text{C}$ )

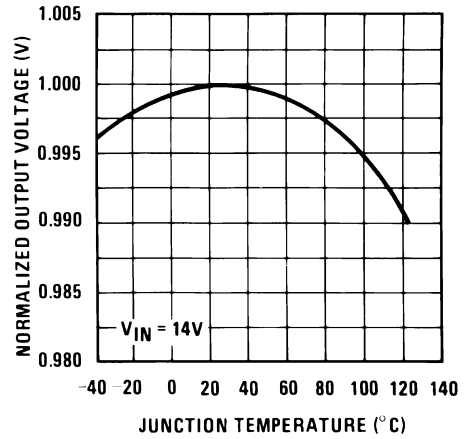

00553916

Dropout Voltage

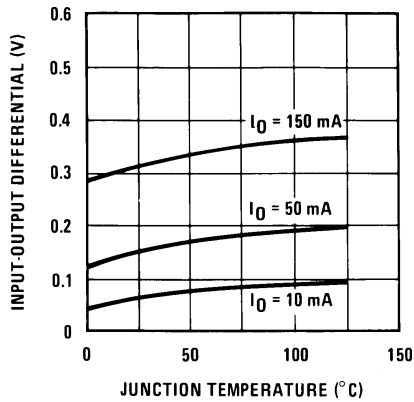

00553917

Dropout Voltage

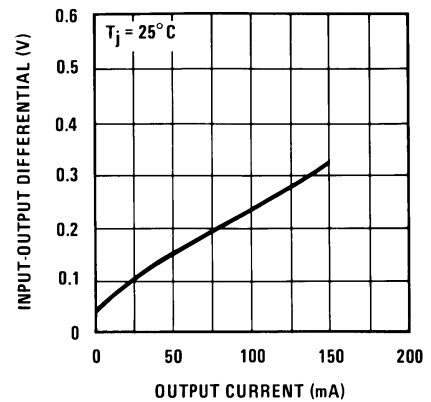

00553918

# Typical Performance Characteristics (Continued)

Low Voltage Behavior

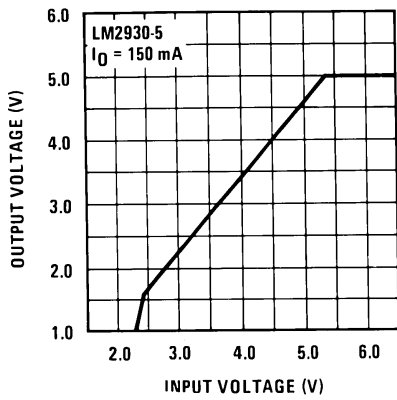

00553919

High Voltage Behavior

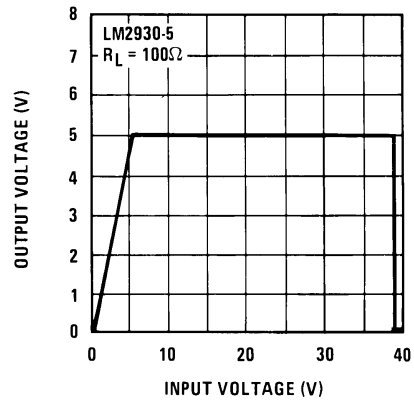

00553920

Line Transient Response

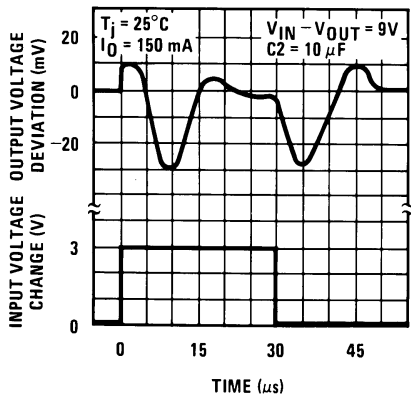

00553921

Load Transient Response

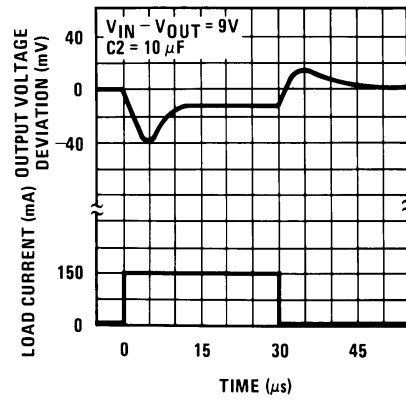

00553922

Peak Output Current

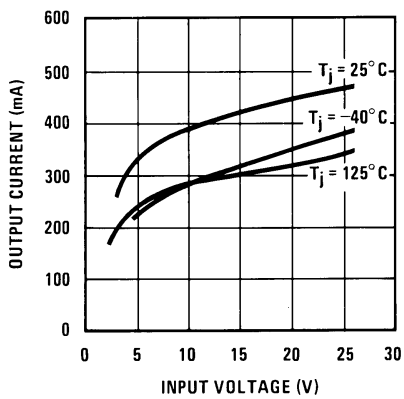

00553923

Quiescent Current

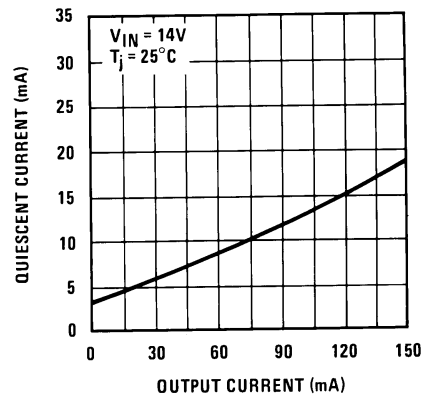

00553924

## Typical Performance Characteristics (Continued)

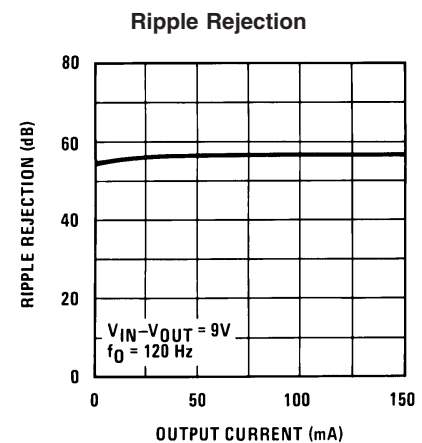
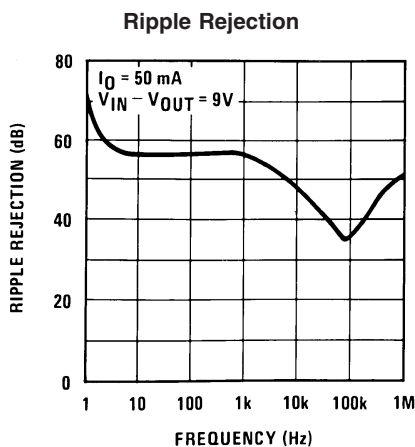
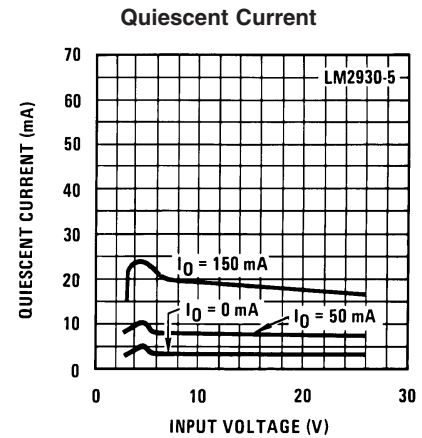
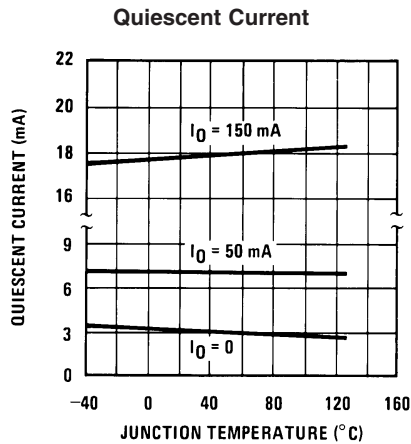

## Definition of Terms

**Dropout Voltage:** The input-output voltage differential at which the circuit ceases to regulate against further reduction in input voltage. Measured when the output voltage has dropped 100 mV from the nominal value obtained at 14V input, dropout voltage is dependent upon load current and junction temperature.

**Input Voltage:** The DC voltage applied to the input terminals with respect to ground.

**Input-Output Differential:** The voltage difference between the unregulated input voltage and the regulated output voltage for which the regulator will operate.

**Line Regulation:** The change in output voltage for a change in the input voltage. The measurement is made under conditions of low dissipation or by using pulse techniques such that the average chip temperature is not significantly affected.

**Load Regulation:** The change in output voltage for a change in load current at constant chip temperature.

**Long Term Stability:** Output voltage stability under accelerated life-test conditions after 1000 hours with maximum rated voltage and junction temperature.

**Output Noise Voltage:** The rms AC voltage at the output, with constant load and no input ripple, measured over a specified frequency range.

**Quiescent Current:** That part of the positive input current that does not contribute to the positive load current. The regulator ground lead current.

**Ripple Rejection:** The ratio of the peak-to-peak input ripple voltage to the peak-to-peak output ripple voltage.

**Temperature Stability of  $V_O$ :** The percentage change in output voltage for a thermal variation from room temperature to either temperature extreme.

Definition of Terms (Continued)

Maximum Power Dissipation (TO-220)

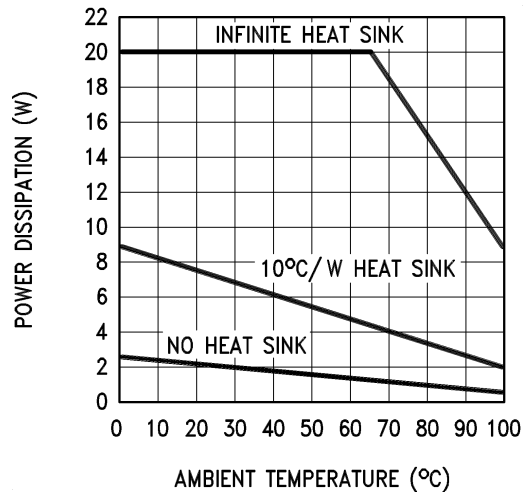

00553906

Maximum Power Dissipation (TO-263) (Note 2)

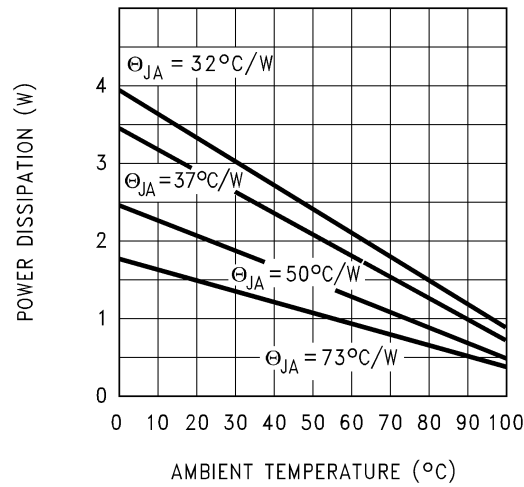

00553909



# Schematic Diagram

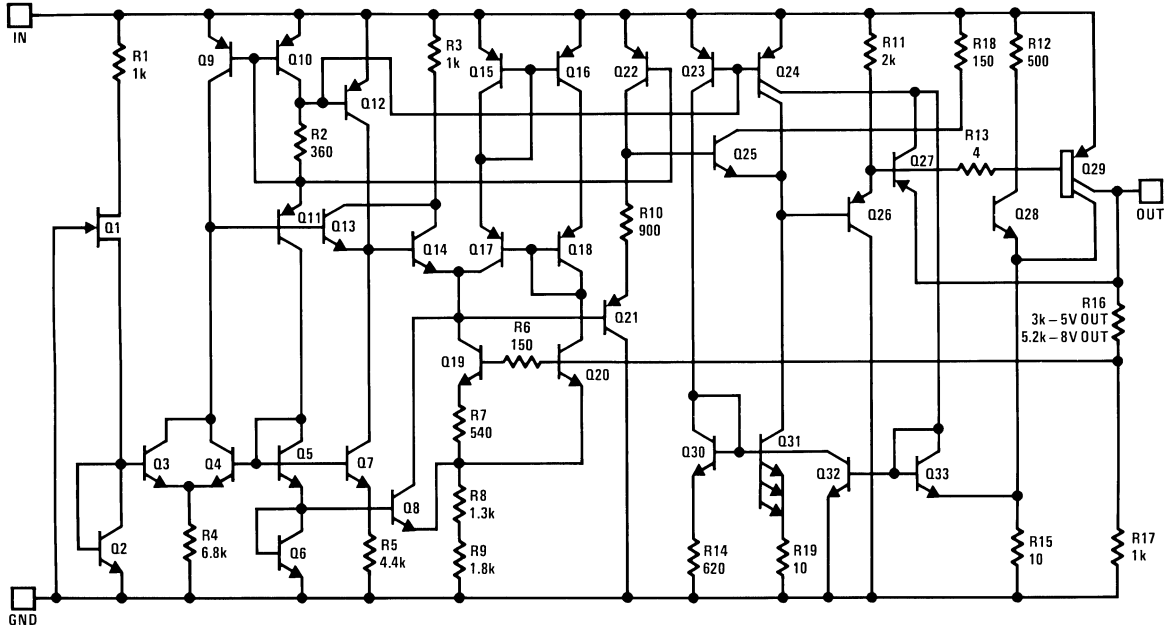

00553910

**Physical Dimensions** inches (millimeters)

unless otherwise noted

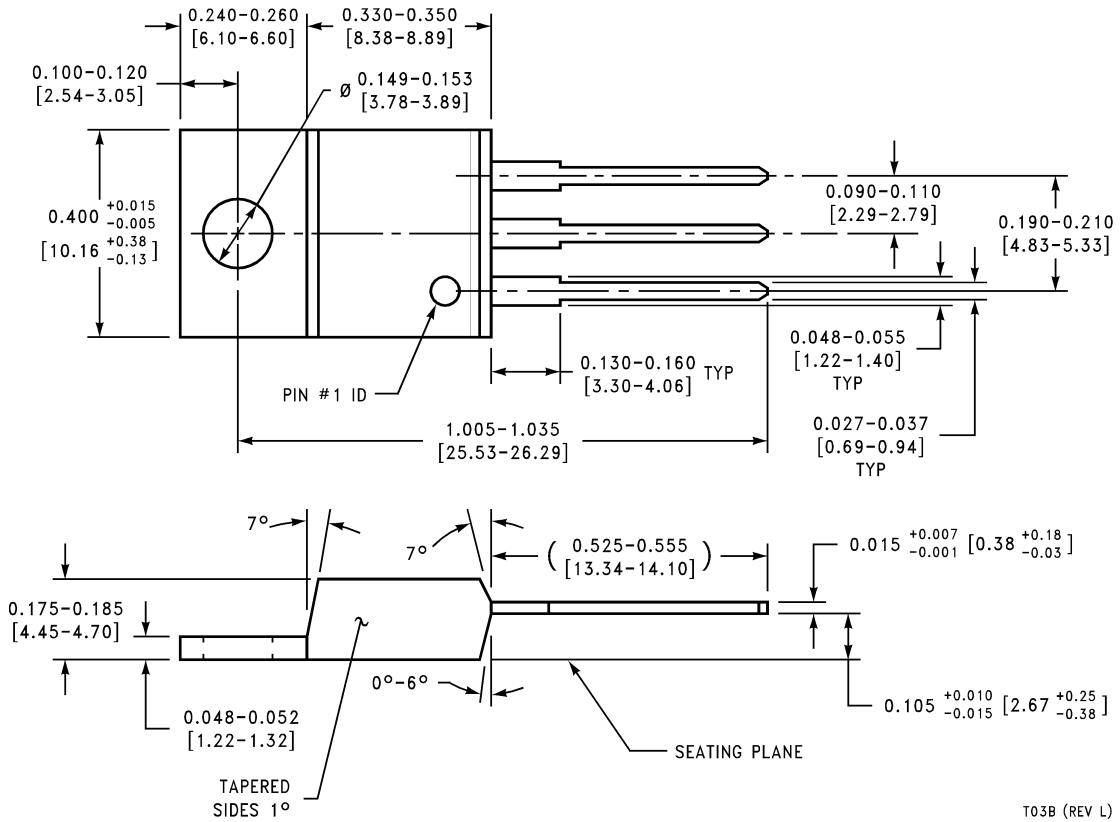

**TO-220 3-Lead Molded Package**  
**Order Number LM2930T-5.0 or LM2930T-8.0**  
**NS Package Number T03B**

T03B (REV L)

**Physical Dimensions** inches (millimeters) unless otherwise noted (Continued)

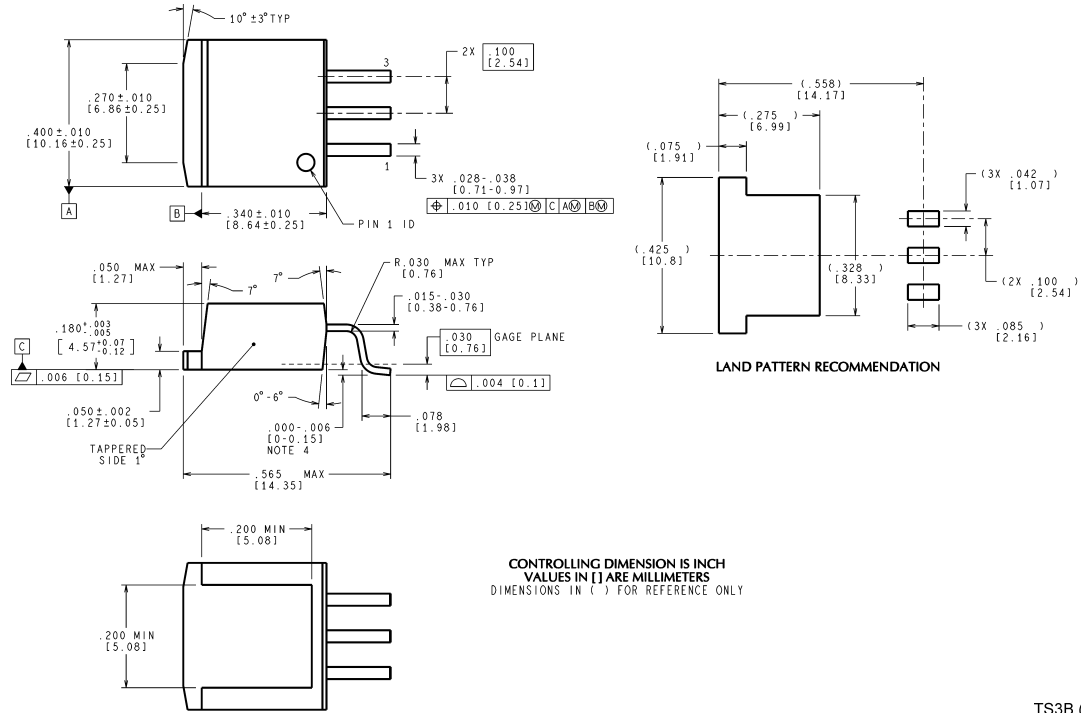

**TO-263 3-Lead Plastic Surface Mount Package**  
**Order Number LM2930S-5.0 or LM2930S-8.0**  
**NS Package Number TS3B**

TS3B (Rev F)

National does not assume any responsibility for use of any circuitry described, no circuit patent licenses are implied and National reserves the right at any time without notice to change said circuitry and specifications.

For the most current product information visit us at [www.national.com](http://www.national.com).

**LIFE SUPPORT POLICY**

NATIONAL'S PRODUCTS ARE NOT AUTHORIZED FOR USE AS CRITICAL COMPONENTS IN LIFE SUPPORT DEVICES OR SYSTEMS WITHOUT THE EXPRESS WRITTEN APPROVAL OF THE PRESIDENT AND GENERAL COUNSEL OF NATIONAL SEMICONDUCTOR CORPORATION. As used herein:

1. Life support devices or systems are devices or systems which, (a) are intended for surgical implant into the body, or (b) support or sustain life, and whose failure to perform when properly used in accordance with instructions for use provided in the labeling, can be reasonably expected to result in a significant injury to the user.
2. A critical component is any component of a life support device or system whose failure to perform can be reasonably expected to cause the failure of the life support device or system, or to affect its safety or effectiveness.

**BANNED SUBSTANCE COMPLIANCE**

National Semiconductor manufactures products and uses packing materials that meet the provisions of the Customer Products Stewardship Specification (CSP-9-111C2) and the Banned Substances and Materials of Interest Specification (CSP-9-111S2) and contain no "Banned Substances" as defined in CSP-9-111S2.

Leadfree products are RoHS compliant.

 **National Semiconductor**  
**Americas Customer Support Center**  
 Email: [new.feedback@nsc.com](mailto:new.feedback@nsc.com)  
 Tel: 1-800-272-9959

**National Semiconductor**  
**Europe Customer Support Center**  
 Fax: +49 (0) 180-530 85 86  
 Email: [europe.support@nsc.com](mailto:europe.support@nsc.com)  
 Deutsch Tel: +49 (0) 69 9508 6208  
 English Tel: +44 (0) 870 24 0 2171  
 Français Tel: +33 (0) 1 41 91 8790

**National Semiconductor**  
**Asia Pacific Customer Support Center**  
 Email: [ap.support@nsc.com](mailto:ap.support@nsc.com)

**National Semiconductor**  
**Japan Customer Support Center**  
 Fax: 81-3-5639-7507  
 Email: [jpn.feedback@nsc.com](mailto:jpn.feedback@nsc.com)  
 Tel: 81-3-5639-7560