

CONNECTORS MANUFACTURE



Pin Header 1.27mm SQ Pin=0.4mm 1 Row H=1.0/1.5/1.7/2.0/2.5mm Straight Type

Specifications

Current Rate:1 AMP
 Insulation Resistance:1000MΩ Min.
 Contact Resistance:20mΩ Max.
 Dielectric Voltage:500V AC for one minute
 Operation Temperature:-40°C to +105°C

Material

Insulator:Polyester,UL 94V-0
 ©Standard:Nylon 6T
 Terminal:Copper Alloy
 Plating:Gold Plated

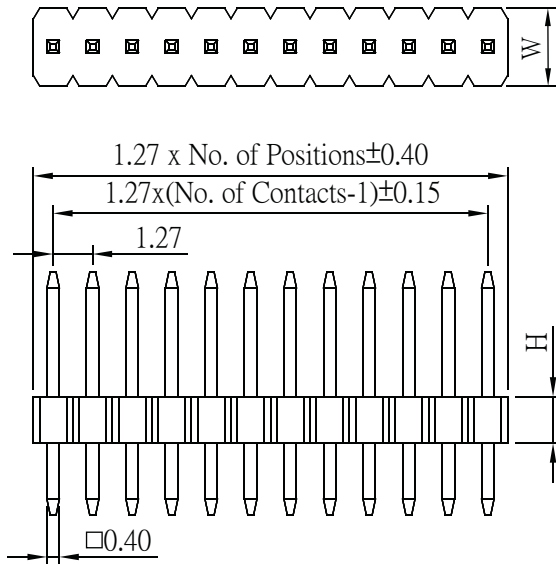

Dim	W
H=1.0mm	2.10
H=1.5mm	2.10
H=1.7mm	2.50
H=2.0mm	2.50
H=2.5mm	2.50

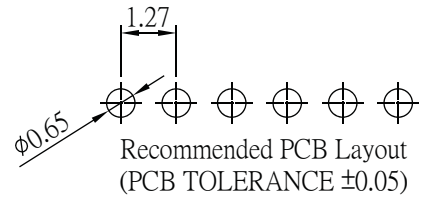
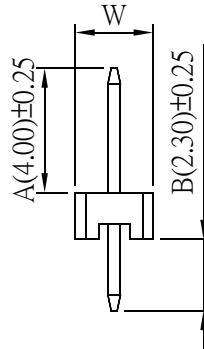

Part No.:PH3S10/15/17/20/25-1XX-U

Pin Header 1.27mm SQ Pin=0.4mm 2 Row H=0.85/1.0/1.5/1.6/1.7/2.0/2.5mm Straight Type

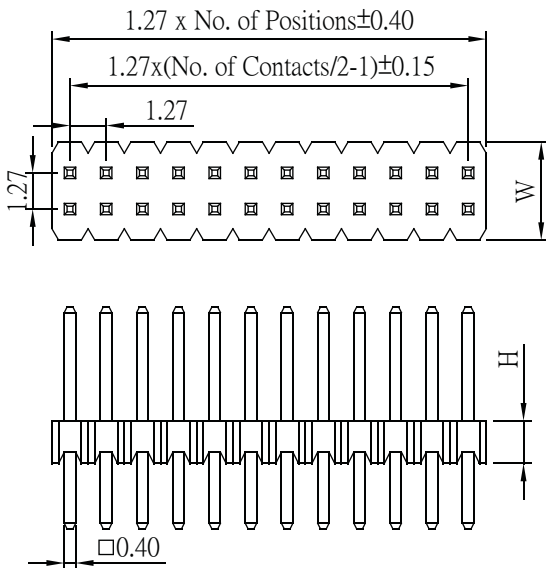

Dim	W
H=0.85mm	3.40
H=1.0mm	3.40
H=1.5mm	3.40
H=1.6mm	3.00
H=1.7mm	3.00
H=2.0mm	3.00
H=2.5mm	3.00

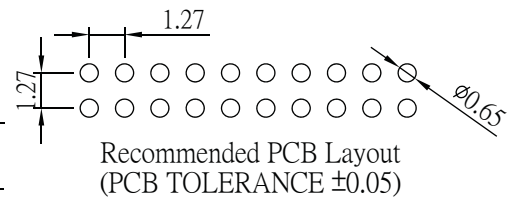
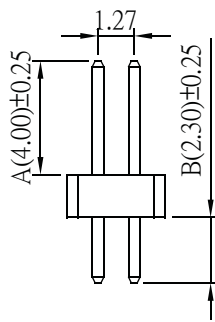

Part No.:PH3S08/10/15/16/17/20/25-2XX-U

ORDER INFORMATION

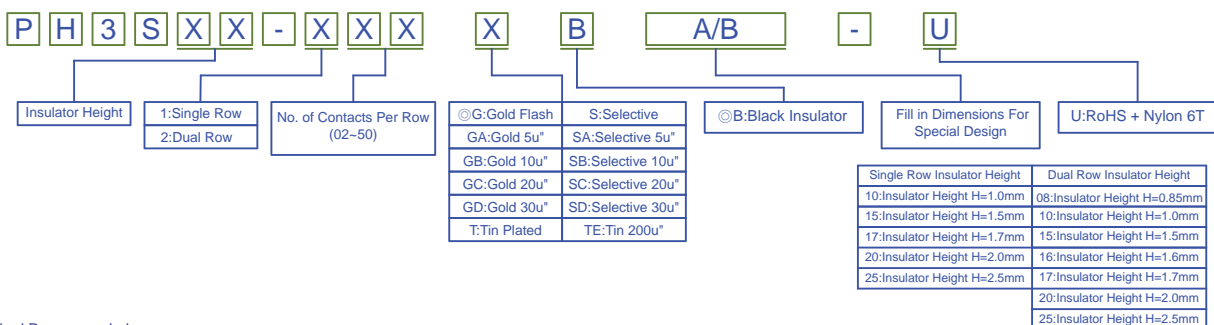

©Standard Recommended