

NST3946DXV6

Complementary General Purpose Transistor

The NST3946DXV6T1 device is a spin-off of our popular SOT-23/SOT-323 three-leaded device. It is designed for general purpose amplifier applications and is housed in the SOT-563 six-leaded surface mount package. By putting two discrete devices in one package, this device is ideal for low-power surface mount applications where board space is at a premium.

- h_{FE} , 100–300
- Low $V_{CE(sat)}$, ≤ 0.4 V
- Simplifies Circuit Design
- Reduces Board Space
- Reduces Component Count
- NSV Prefix for Automotive and Other Applications Requiring Unique Site and Control Change Requirements; AEC-Q101 Qualified and PPAP Capable
- These Devices are Pb-Free, Halogen Free/BFR Free and are RoHS Compliant

Table 1. MAXIMUM RATINGS

Rating	Symbol	Value	Unit
Collector–Emitter Voltage (NPN) (PNP)	V_{CEO}	40 –40	Vdc
Collector–Base Voltage (NPN) (PNP)	V_{CBO}	60 –40	Vdc
Emitter–Base Voltage (NPN) (PNP)	V_{EBO}	6.0 –5.0	Vdc
Collector Current – Continuous (NPN) (PNP)	I_C	200 –200	mAdc
Electrostatic Discharge	ESD	HBM>16000, MM>2000	V

Stresses exceeding those listed in the Maximum Ratings table may damage the device. If any of these limits are exceeded, device functionality should not be assumed, damage may occur and reliability may be affected.



ON Semiconductor®

<http://onsemi.com>



**SOT-563
CASE 463A**

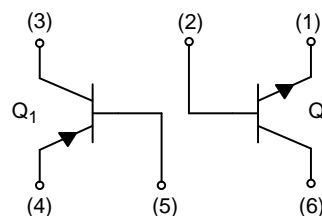

NST3946DXV6T1*

*Q1 PNP
Q2 NPN

MARKING DIAGRAM



46 = Specific Device Code
M = Date Code
▪ = Pb-Free Package

(Note: Microdot may be in either location)

ORDERING INFORMATION

Device	Package	Shipping†
NST3946DXV6T1G	SOT-563 (Pb-Free)	4,000 / Tape & Reel
NSVT3946DXV6T1G	SOT-563 (Pb-Free)	4,000 / Tape & Reel
NST3946DXV6T5G	SOT-563 (Pb-Free)	8,000 / Tape & Reel

†For information on tape and reel specifications, including part orientation and tape sizes, please refer to our Tape and Reel Packaging Specification Brochure, BRD8011/D.

NST3946DXV6

Table 2. THERMAL CHARACTERISTICS

Characteristic (One Junction Heated)		Symbol	Max	Unit
Total Device Dissipation Derate above 25°C	$T_A = 25^\circ\text{C}$	P_D	357 (Note 1) 2.9 (Note 1)	mW mW/°C
Thermal Resistance Junction-to-Ambient		$R_{\theta JA}$	350 (Note 1)	°C/W
Characteristic (Both Junctions Heated)		Symbol	Max	Unit
Total Device Dissipation Derate above 25°C	$T_A = 25^\circ\text{C}$	P_D	500 (Note 1) 4.0 (Note 1)	mW mW/°C
Thermal Resistance Junction-to-Ambient		$R_{\theta JA}$	250 (Note 1)	°C/W
Junction and Storage Temperature Range		T_J, T_{stg}	55 to +150	°C

1. FR-4 @ Minimum Pad

ELECTRICAL CHARACTERISTICS ($T_A = 25^\circ\text{C}$ unless otherwise noted)

Characteristic		Symbol	Min	Max	Unit
OFF CHARACTERISTICS					
Collector – Emitter Breakdown Voltage (Note 2) ($I_C = 1.0\text{ mAdc}, I_B = 0$) ($I_C = -1.0\text{ mAdc}, I_B = 0$)	(NPN) (PNP)	$V_{(BR)CEO}$	40 -40	- -	Vdc
Collector – Base Breakdown Voltage ($I_C = 10\text{ }\mu\text{A dc}, I_E = 0$) ($I_C = -10\text{ }\mu\text{A dc}, I_E = 0$)	(NPN) (PNP)	$V_{(BR)CBO}$	60 -40	- -	Vdc
Emitter – Base Breakdown Voltage ($I_E = 10\text{ }\mu\text{A dc}, I_C = 0$) ($I_E = -10\text{ }\mu\text{A dc}, I_C = 0$)	(NPN) (PNP)	$V_{(BR)EBO}$	6.0 -5.0	- -	Vdc
Base Cutoff Current ($V_{CE} = 30\text{ Vdc}, V_{EB} = 3.0\text{ Vdc}$) ($V_{CE} = -30\text{ Vdc}, V_{EB} = -3.0\text{ Vdc}$)	(NPN) (PNP)	I_{BL}	- -	50 -50	nA dc
Collector Cutoff Current ($V_{CE} = 30\text{ Vdc}, V_{EB} = 3.0\text{ Vdc}$) ($V_{CE} = -30\text{ Vdc}, V_{EB} = -3.0\text{ Vdc}$)	(NPN) (PNP)	I_{CEX}	- -	50 -50	nA dc
ON CHARACTERISTICS (Note 2)					
DC Current Gain ($I_C = 0.1\text{ mA dc}, V_{CE} = 1.0\text{ Vdc}$) ($I_C = 1.0\text{ mA dc}, V_{CE} = 1.0\text{ Vdc}$) ($I_C = 10\text{ mA dc}, V_{CE} = 1.0\text{ Vdc}$) ($I_C = 50\text{ mA dc}, V_{CE} = 1.0\text{ Vdc}$) ($I_C = 100\text{ mA dc}, V_{CE} = 1.0\text{ Vdc}$) ($I_C = -0.1\text{ mA dc}, V_{CE} = -1.0\text{ Vdc}$) ($I_C = -1.0\text{ mA dc}, V_{CE} = -1.0\text{ Vdc}$) ($I_C = -10\text{ mA dc}, V_{CE} = -1.0\text{ Vdc}$) ($I_C = -50\text{ mA dc}, V_{CE} = -1.0\text{ Vdc}$) ($I_C = -100\text{ mA dc}, V_{CE} = -1.0\text{ Vdc}$)	(NPN) (PNP)	h_{FE}	40 70 100 60 30 60 80 100 60 30	- - 300 - - - - 300 - -	-
Collector – Emitter Saturation Voltage ($I_C = 10\text{ mA dc}, I_B = 1.0\text{ mA dc}$) ($I_C = 50\text{ mA dc}, I_B = 5.0\text{ mA dc}$) ($I_C = -10\text{ mA dc}, I_B = -1.0\text{ mA dc}$) ($I_C = -50\text{ mA dc}, I_B = -5.0\text{ mA dc}$)	(NPN) (PNP)	$V_{CE(sat)}$	- - - -	0.2 0.3 -0.25 -0.4	Vdc
Base – Emitter Saturation Voltage ($I_C = 10\text{ mA dc}, I_B = 1.0\text{ mA dc}$) ($I_C = 50\text{ mA dc}, I_B = 5.0\text{ mA dc}$) ($I_C = -10\text{ mA dc}, I_B = -1.0\text{ mA dc}$) ($I_C = -50\text{ mA dc}, I_B = -5.0\text{ mA dc}$)	(NPN) (PNP)	$V_{BE(sat)}$	0.65 - -0.65 -	0.85 0.95 -0.85 -0.95	Vdc

NST3946DXV6

ELECTRICAL CHARACTERISTICS (T_A = 25°C unless otherwise noted) (continued)

Characteristic	Symbol	Min	Max	Unit
SMALL-SIGNAL CHARACTERISTICS				
Current-Gain – Bandwidth Product (I _C = 10 mAdc, V _{CE} = 20 Vdc, f = 100 MHz) (I _C = -10 mAdc, V _{CE} = -20 Vdc, f = 100 MHz)	f _T (NPN) (PNP)	300 250	– –	MHz
Output Capacitance (V _{CB} = 5.0 Vdc, I _E = 0, f = 1.0 MHz) (V _{CB} = -5.0 Vdc, I _E = 0, f = 1.0 MHz)	C _{obo} (NPN) (PNP)	– –	4.0 4.5	pF
Input Capacitance (V _{EB} = 0.5 Vdc, I _C = 0, f = 1.0 MHz) (V _{EB} = -0.5 Vdc, I _C = 0, f = 1.0 MHz)	C _{ibo} (NPN) (PNP)	– –	8.0 10.0	pF
Input Impedance (V _{CE} = 10 Vdc, I _C = 1.0 mAdc, f = 1.0 kHz) (V _{CE} = -10 Vdc, I _C = -1.0 mAdc, f = 1.0 kHz)	h _{ie} (NPN) (PNP)	1.0 2.0	10 12	k Ω
Voltage Feedback Ratio (V _{CE} = 10 Vdc, I _C = 1.0 mAdc, f = 1.0 kHz) (V _{CE} = -10 Vdc, I _C = -1.0 mAdc, f = 1.0 kHz)	h _{re} (NPN) (PNP)	0.5 0.1	8.0 10	X 10 ⁻⁴
Small-Signal Current Gain (V _{CE} = 10 Vdc, I _C = 1.0 mAdc, f = 1.0 kHz) (V _{CE} = -10 Vdc, I _C = -1.0 mAdc, f = 1.0 kHz)	h _{fe} (NPN) (PNP)	100 100	400 400	–
Output Admittance (V _{CE} = 10 Vdc, I _C = 1.0 mAdc, f = 1.0 kHz) (V _{CE} = -10 Vdc, I _C = -1.0 mAdc, f = 1.0 kHz)	h _{oe} (NPN) (PNP)	1.0 3.0	40 60	μmhos
Noise Figure (V _{CE} = 5.0 Vdc, I _C = 100 μAdc, R _S = 1.0 k Ω, f = 1.0 kHz) (V _{CE} = -5.0 Vdc, I _C = -100 μAdc, R _S = 1.0 k Ω, f = 1.0 kHz)	NF (NPN) (PNP)	– –	5.0 4.0	dB

SWITCHING CHARACTERISTICS

Delay Time (V _{CC} = 3.0 Vdc, V _{BE} = -0.5 Vdc) (V _{CC} = -3.0 Vdc, V _{BE} = 0.5 Vdc)	t _d (NPN) (PNP)	– –	35 35	ns
Rise Time (I _C = 10 mAdc, I _{B1} = 1.0 mAdc) (I _C = -10 mAdc, I _{B1} = -1.0 mAdc)	t _r (NPN) (PNP)	– –	35 35	
Storage Time (V _{CC} = 3.0 Vdc, I _C = 10 mAdc) (V _{CC} = -3.0 Vdc, I _C = -10 mAdc)	t _s (NPN) (PNP)	– –	200 225	ns
Fall Time (I _{B1} = I _{B2} = 1.0 mAdc) (I _{B1} = I _{B2} = -1.0 mAdc)	t _f (NPN) (PNP)	– –	50 75	

Product parametric performance is indicated in the Electrical Characteristics for the listed test conditions, unless otherwise noted. Product performance may not be indicated by the Electrical Characteristics if operated under different conditions.

2. Pulse Test: Pulse Width ≤ 300 μs; Duty Cycle ≤ 2.0%.

NST3946DXV6

(NPN)

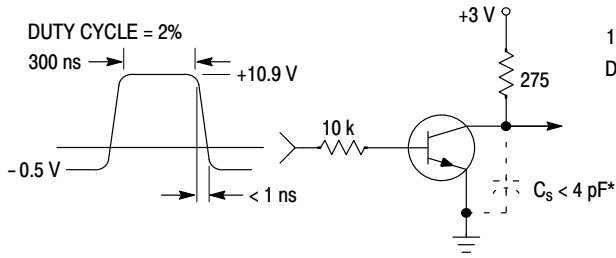

Figure 1. Delay and Rise Time Equivalent Test Circuit

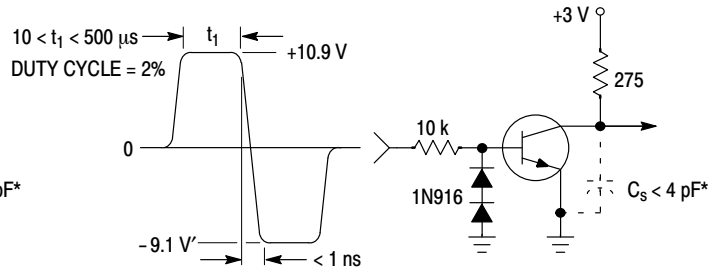

Figure 2. Storage and Fall Time Equivalent Test Circuit

* Total shunt capacitance of test jig and connectors

TYPICAL TRANSIENT CHARACTERISTICS

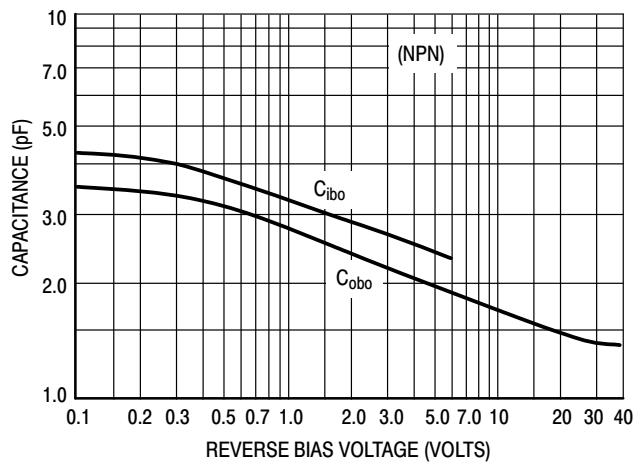

Figure 3. Capacitance

NST3946DXV6

(NPN)

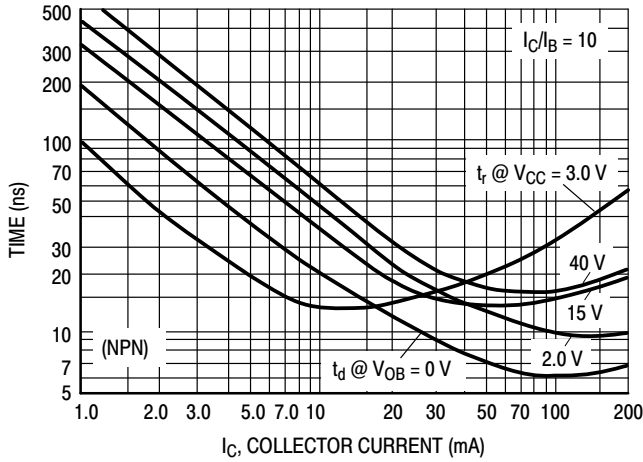

Figure 4. Turn-On Time

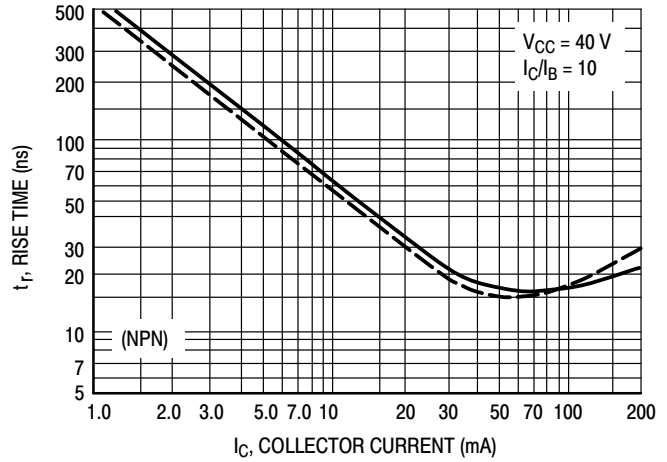

Figure 5. Rise Time

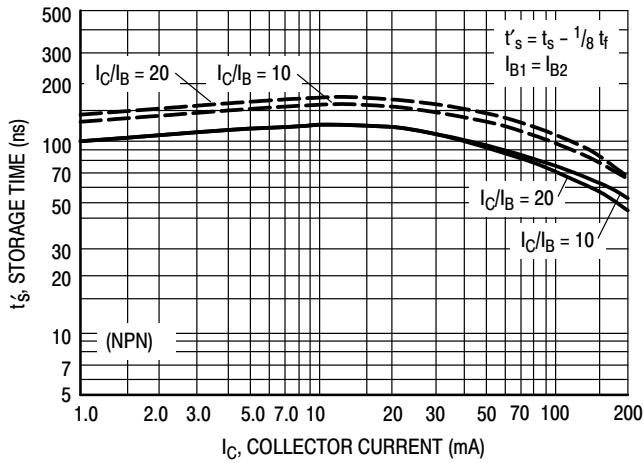

Figure 6. Storage Time

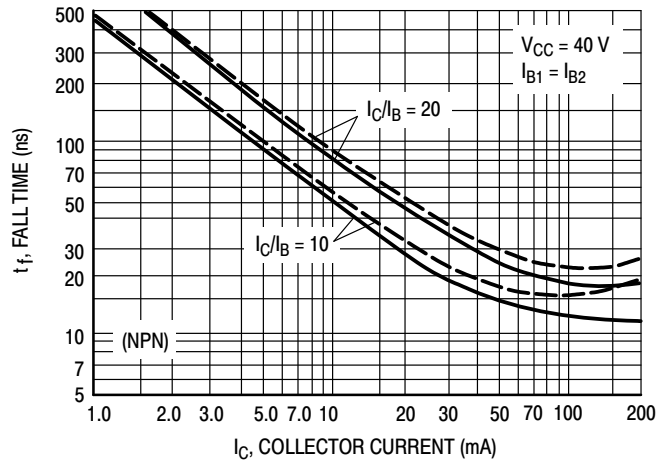

Figure 7. Fall Time

TYPICAL AUDIO SMALL-SIGNAL CHARACTERISTICS NOISE FIGURE VARIATIONS

($V_{CE} = 5.0 \text{ Vdc}$, $T_A = 25^\circ\text{C}$, Bandwidth = 1.0 Hz)

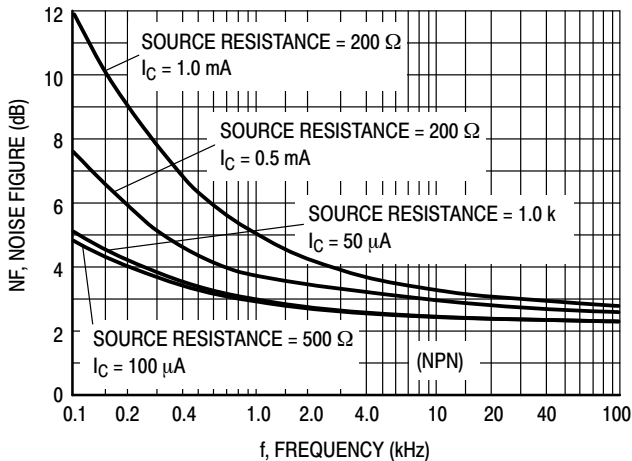

Figure 8. Noise Figure

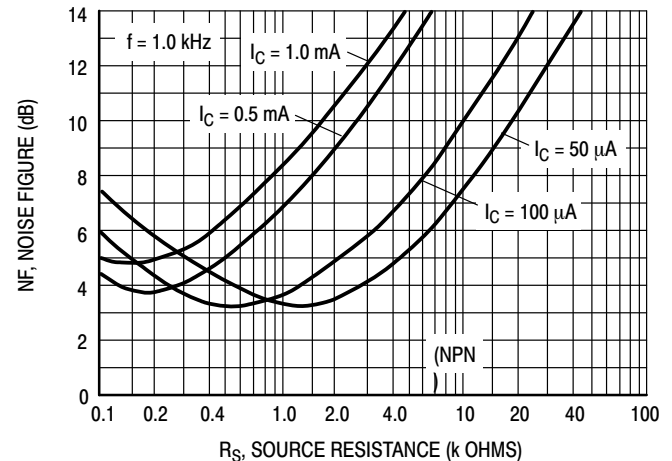

Figure 9. Noise Figure

NST3946DXV6

(NPN)

h PARAMETERS

($V_{CE} = 10 \text{ Vdc}$, $f = 1.0 \text{ kHz}$, $T_A = 25^\circ\text{C}$)

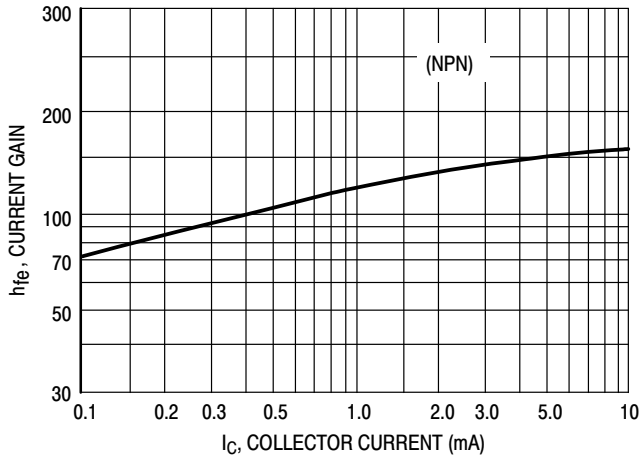

Figure 10. Current Gain

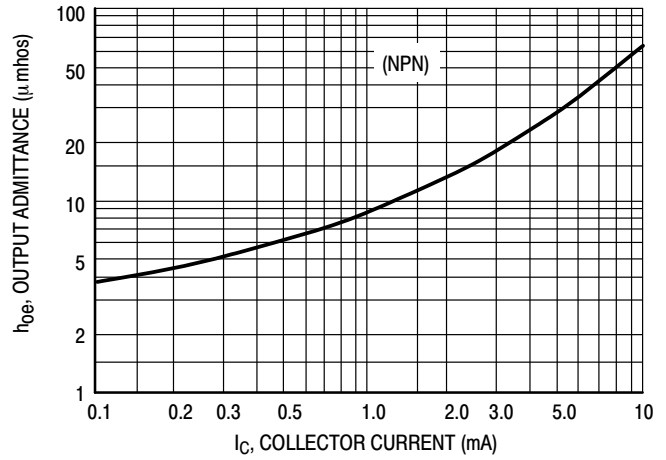

Figure 11. Output Admittance

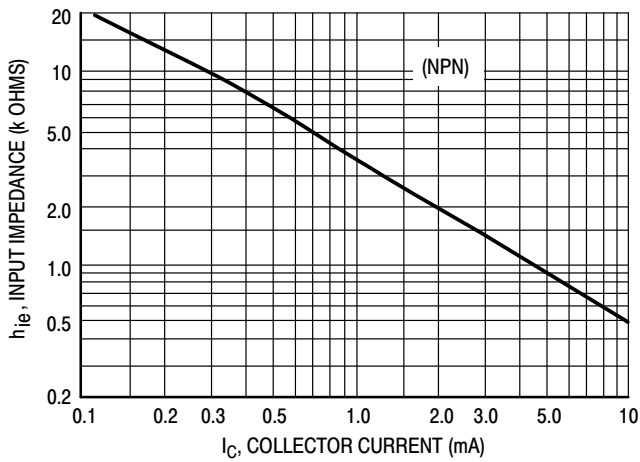

Figure 12. Input Impedance

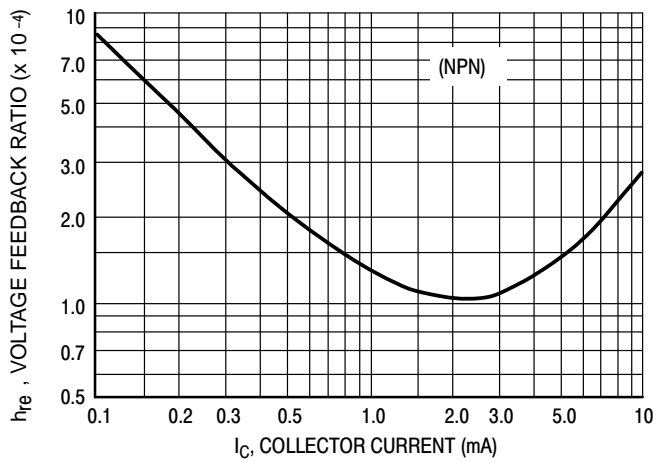

Figure 13. Voltage Feedback Ratio

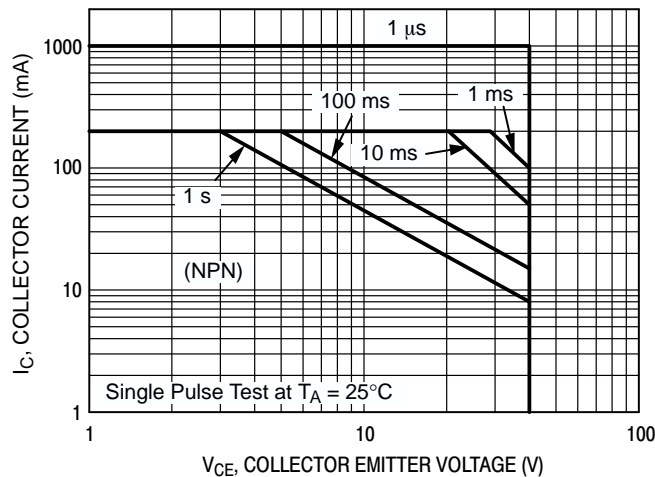

Figure 14. Safe Operating Area

NST3946DXV6

(NPN)

TYPICAL STATIC CHARACTERISTICS

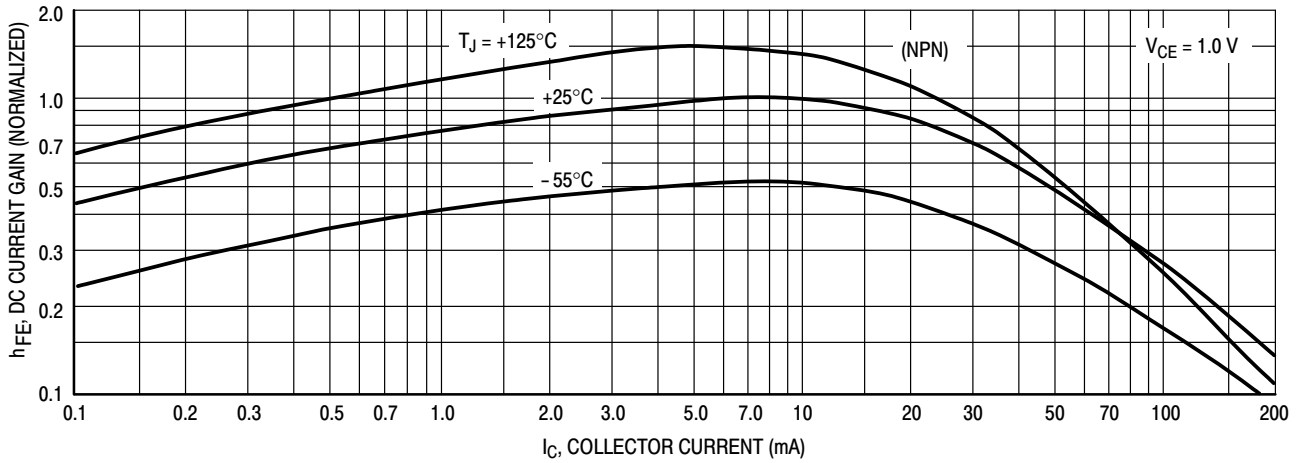

Figure 15. DC Current Gain

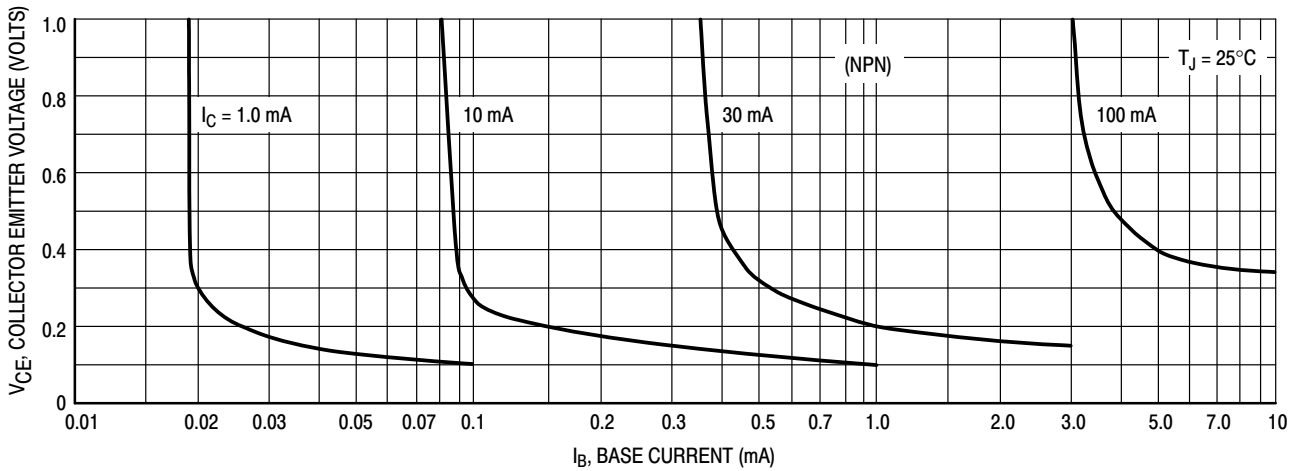

Figure 16. Collector Saturation Region

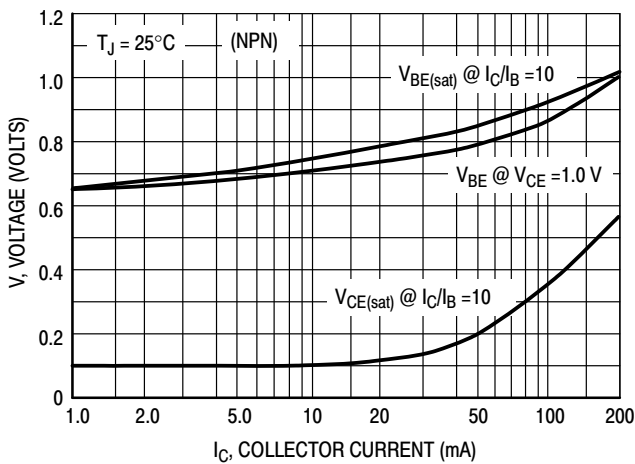

Figure 17. "ON" Voltages

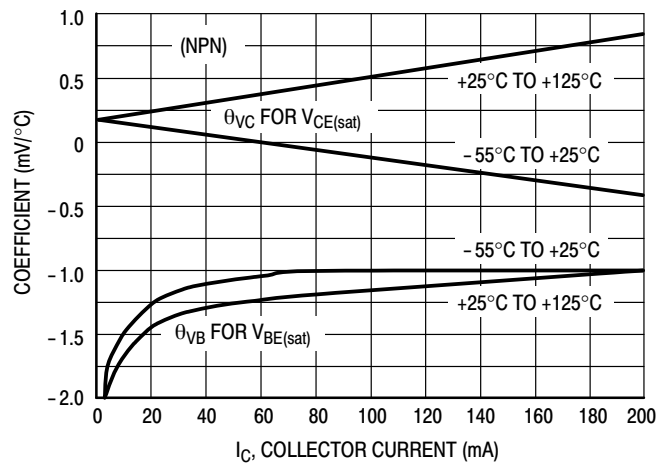

Figure 18. Temperature Coefficients

NST3946DXV6

(PNP)

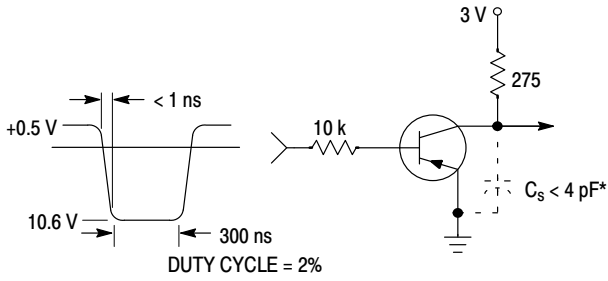

Figure 19. Delay and Rise Time Equivalent Test Circuit

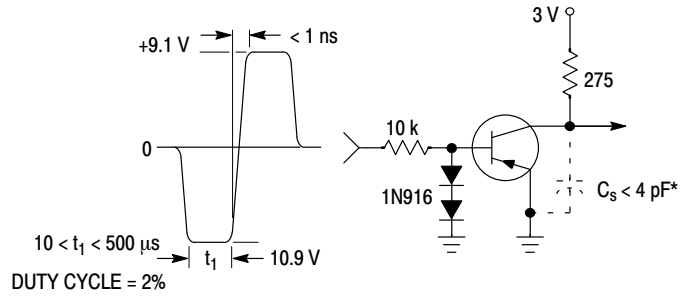

Figure 20. Storage and Fall Time Equivalent Test Circuit

* Total shunt capacitance of test jig and connectors

TYPICAL TRANSIENT CHARACTERISTICS

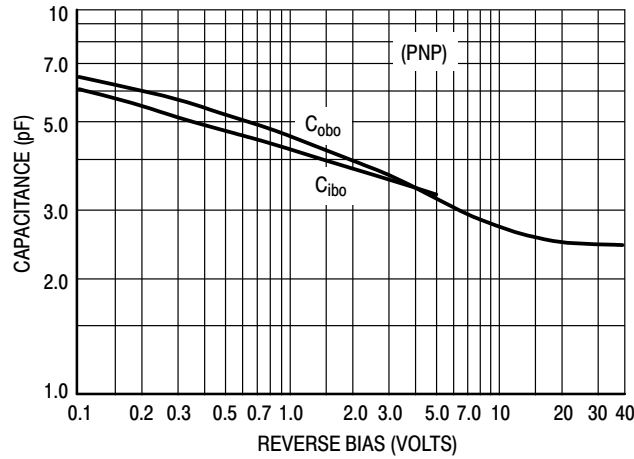

Figure 21. Capacitance

— $T_J = 25^\circ\text{C}$
 - - - $T_J = 125^\circ\text{C}$

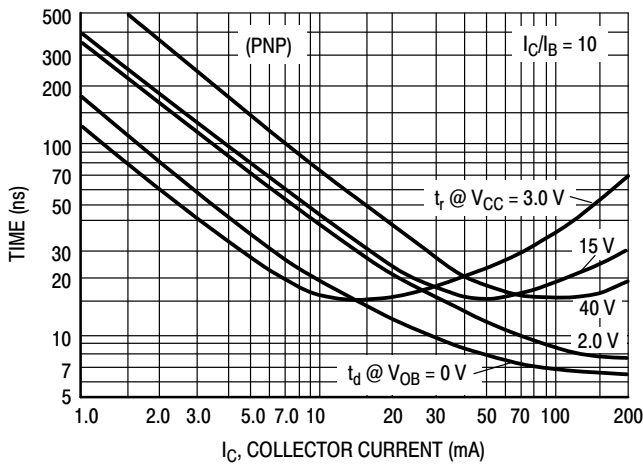

Figure 22. Turn-On Time

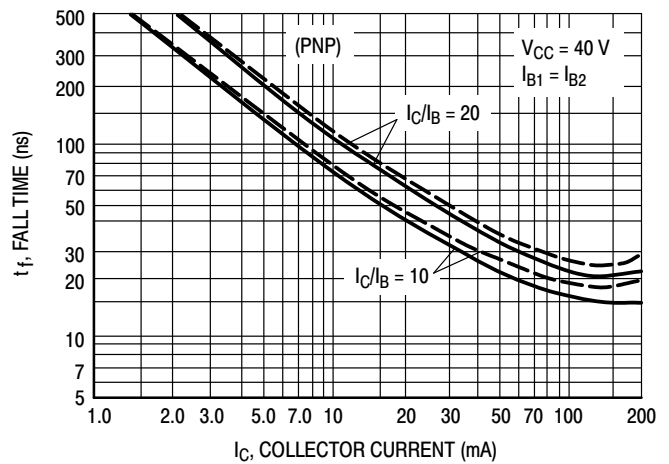

Figure 23. Fall Time

NST3946DXV6

(PNP)

TYPICAL AUDIO SMALL-SIGNAL CHARACTERISTICS NOISE FIGURE VARIATIONS

($V_{CE} = -5.0$ Vdc, $T_A = 25^\circ\text{C}$, Bandwidth = 1.0 Hz)

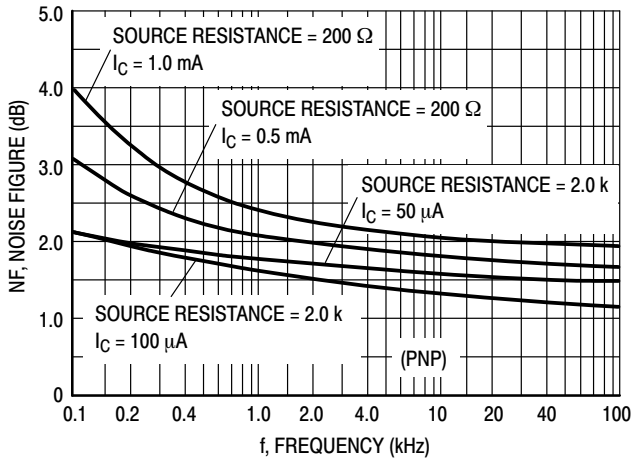

Figure 24.

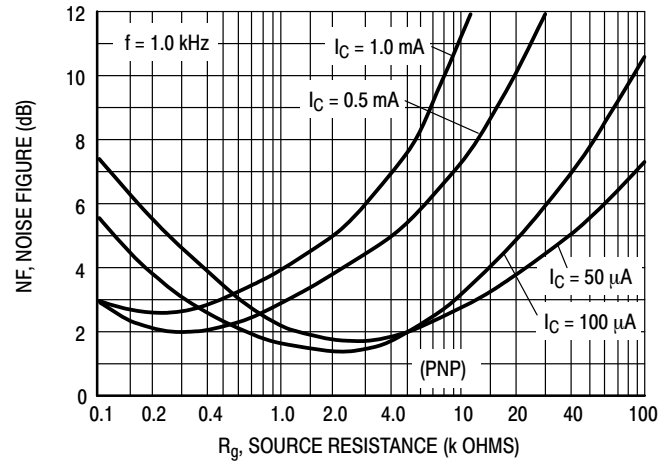

Figure 25.

h PARAMETERS

($V_{CE} = -10$ Vdc, $f = 1.0$ kHz, $T_A = 25^\circ\text{C}$)

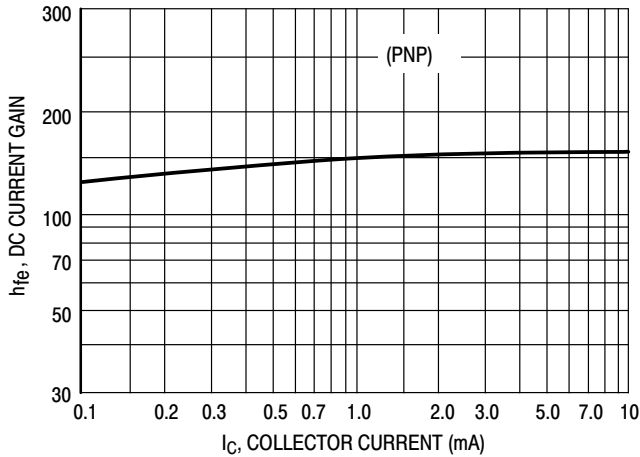

Figure 26. Current Gain

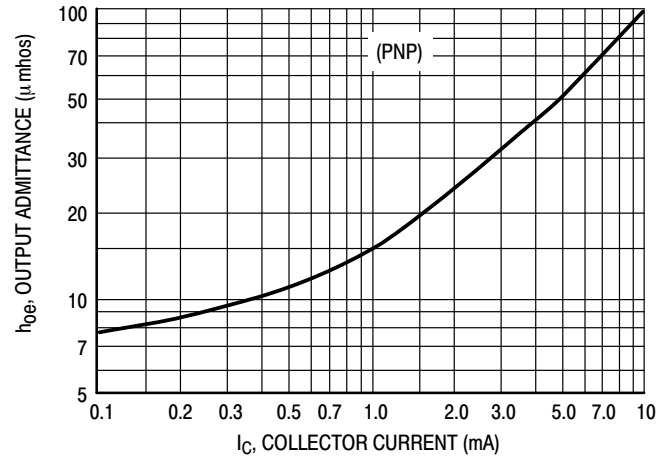

Figure 27. Output Admittance

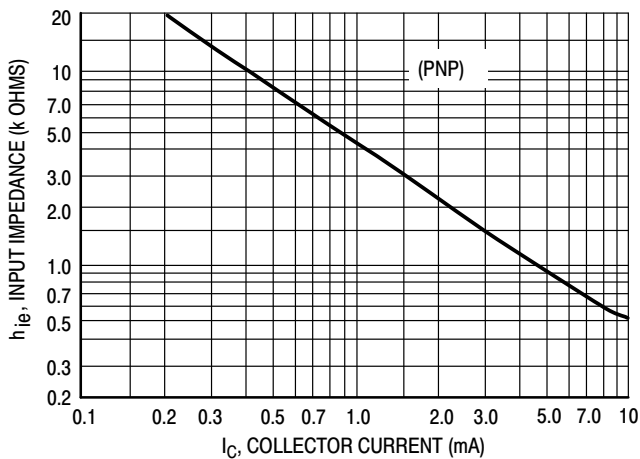

Figure 28. Input Impedance

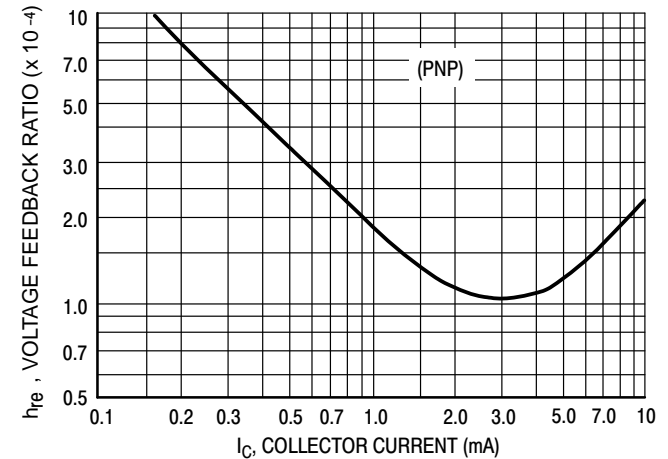

Figure 29. Voltage Feedback Ratio

NST3946DXV6

(PNP)

TYPICAL STATIC CHARACTERISTICS

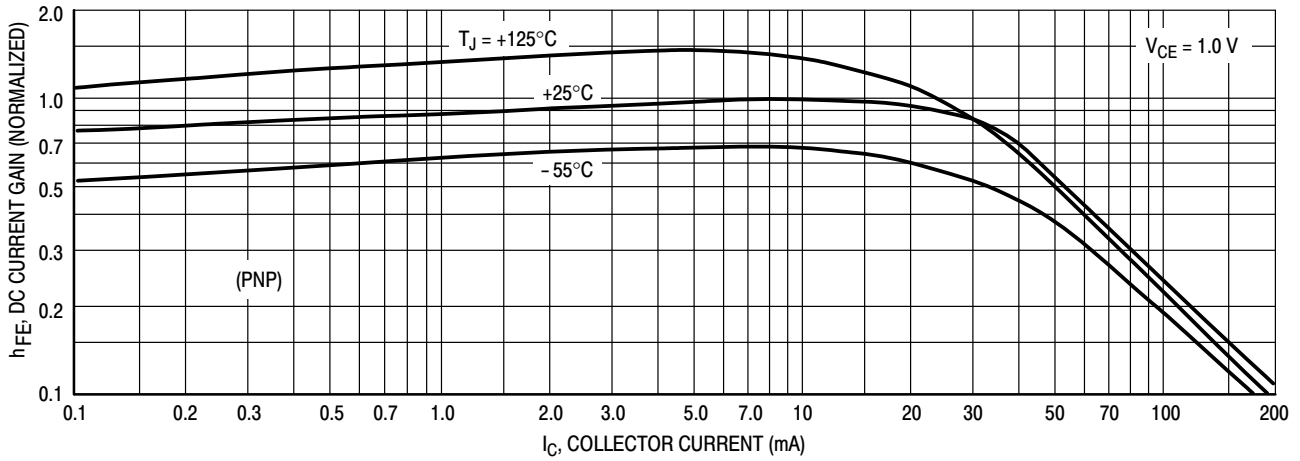

Figure 30. DC Current Gain

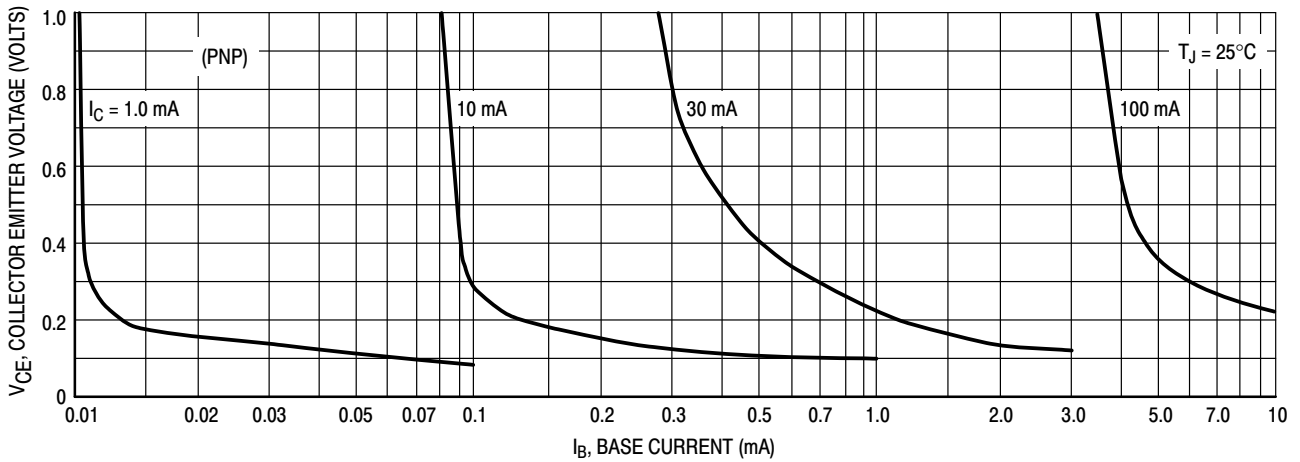

Figure 31. Collector Saturation Region

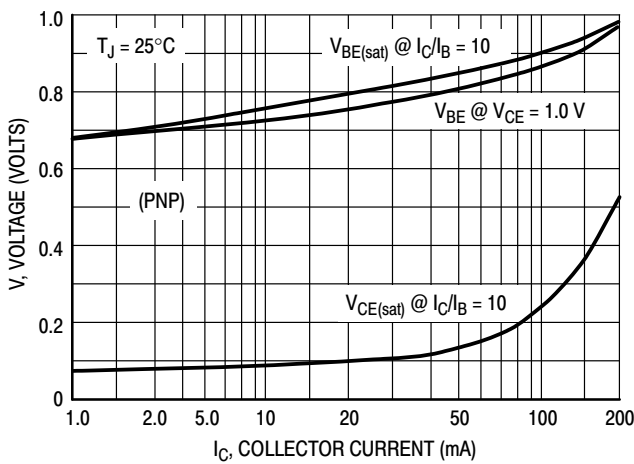

Figure 32. "ON" Voltages

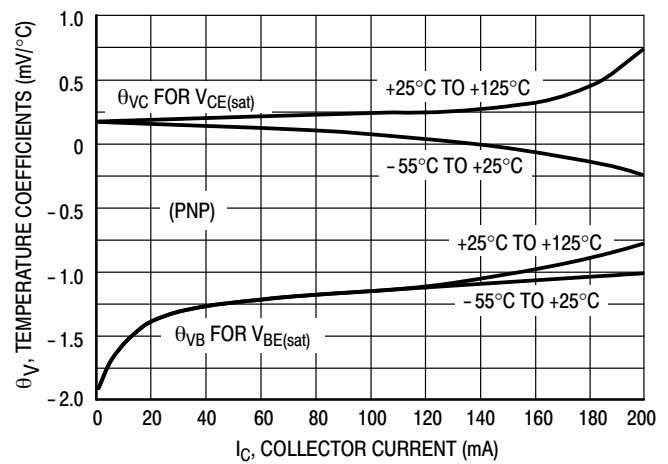

Figure 33. Temperature Coefficients

NST3946DXV6

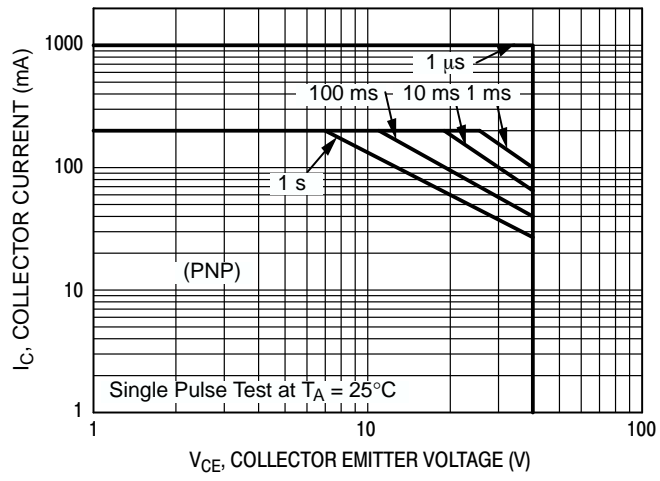
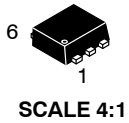

Figure 34. Safe Operating Area

MECHANICAL CASE OUTLINE

PACKAGE DIMENSIONS



SOT-563, 6 LEAD
CASE 463A
ISSUE H

DATE 26 JAN 2021

NOTES:

1. DIMENSIONING AND TOLERANCING PER ASME Y14.5M, 2009.
2. CONTROLLING DIMENSION: MILLIMETERS
3. MAXIMUM LEAD THICKNESS INCLUDES LEAD FINISH THICKNESS. MINIMUM LEAD THICKNESS IS THE MINIMUM THICKNESS OF BASE MATERIAL.

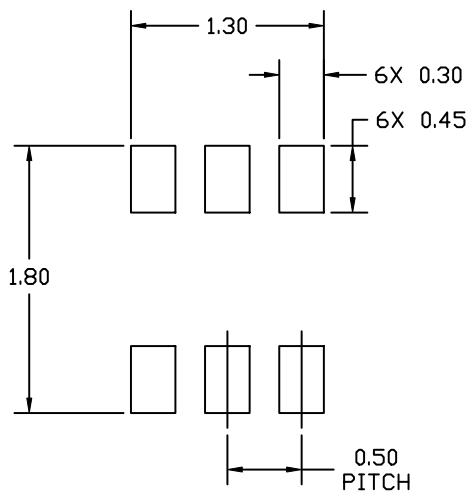
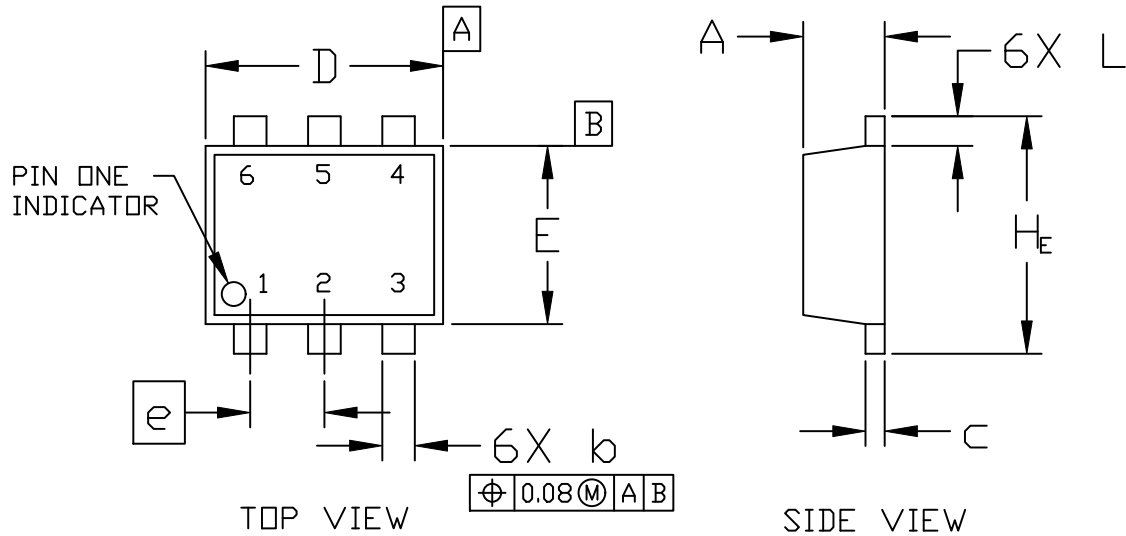

DIM	MILLIMETERS		
	MIN.	NOM.	MAX.
A	0.50	0.55	0.60
b	0.17	0.22	0.27
c	0.08	0.13	0.18
D	1.50	1.60	1.70
E	1.10	1.20	1.30
e	0.50 BSC		
L	0.10	0.20	0.30
H _E	1.50	1.60	1.70

RECOMMENDED MOUNTING FOOTPRINT*

* For additional information on our Pb-Free strategy and soldering details, please download the ON Semiconductor Soldering and Mounting Techniques Reference Manual, SOLDERRM/D.

DOCUMENT NUMBER:	98AON11126D	Electronic versions are uncontrolled except when accessed directly from the Document Repository. Printed versions are uncontrolled except when stamped "CONTROLLED COPY" in red.
DESCRIPTION:	SOT-563, 6 LEAD	PAGE 1 OF 2

onsemi and ONSEMI are trademarks of Semiconductor Components Industries, LLC dba onsemi or its subsidiaries in the United States and/or other countries. onsemi reserves the right to make changes without further notice to any products herein. onsemi makes no warranty, representation or guarantee regarding the suitability of its products for any particular purpose, nor does onsemi assume any liability arising out of the application or use of any product or circuit, and specifically disclaims any and all liability, including without limitation special, consequential or incidental damages. onsemi does not convey any license under its patent rights nor the rights of others.

MECHANICAL CASE OUTLINE

PACKAGE DIMENSIONS



SOT-563, 6 LEAD

CASE 463A
ISSUE H

DATE 26 JAN 2021

- | | | |
|---|--|---|
| <p>STYLE 1:
PIN 1. EMITTER 1
2. BASE 1
3. COLLECTOR 2
4. EMITTER 2
5. BASE 2
6. COLLECTOR 1</p> | <p>STYLE 2:
PIN 1. EMITTER 1
2. EMITTER 2
3. BASE 2
4. COLLECTOR 2
5. BASE 1
6. COLLECTOR 1</p> | <p>STYLE 3:
PIN 1. CATHODE 1
2. CATHODE 1
3. ANODE/ANODE 2
4. CATHODE 2
5. CATHODE 2
6. ANODE/ANODE 1</p> |
| <p>STYLE 4:
PIN 1. COLLECTOR
2. COLLECTOR
3. BASE
4. EMITTER
5. COLLECTOR
6. COLLECTOR</p> | <p>STYLE 5:
PIN 1. CATHODE
2. CATHODE
3. ANODE
4. ANODE
5. CATHODE
6. CATHODE</p> | <p>STYLE 6:
PIN 1. CATHODE
2. ANODE
3. CATHODE
4. CATHODE
5. CATHODE
6. CATHODE</p> |
| <p>STYLE 7:
PIN 1. CATHODE
2. ANODE
3. CATHODE
4. CATHODE
5. ANODE
6. CATHODE</p> | <p>STYLE 8:
PIN 1. DRAIN
2. DRAIN
3. GATE
4. SOURCE
5. DRAIN
6. DRAIN</p> | <p>STYLE 9:
PIN 1. SOURCE 1
2. GATE 1
3. DRAIN 2
4. SOURCE 2
5. GATE 2
6. DRAIN 1</p> |
| <p>STYLE 10:
PIN 1. CATHODE 1
2. N/C
3. CATHODE 2
4. ANODE 2
5. N/C
6. ANODE 1</p> | <p>STYLE 11:
PIN 1. EMITTER 2
2. BASE 2
3. COLLECTOR 1
4. EMITTER 1
5. BASE 1
6. COLLECTOR 2</p> | |

GENERIC MARKING DIAGRAM*

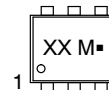

XX = Specific Device Code
M = Month Code
▪ = Pb-Free Package

*This information is generic. Please refer to device data sheet for actual part marking. Pb-Free indicator, "G" or microdot "▪", may or may not be present. Some products may not follow the Generic Marking.

DOCUMENT NUMBER:	98AON11126D	Electronic versions are uncontrolled except when accessed directly from the Document Repository. Printed versions are uncontrolled except when stamped "CONTROLLED COPY" in red.
DESCRIPTION:	SOT-563, 6 LEAD	PAGE 2 OF 2

onsemi and onsemi are trademarks of Semiconductor Components Industries, LLC dba onsemi or its subsidiaries in the United States and/or other countries. onsemi reserves the right to make changes without further notice to any products herein. onsemi makes no warranty, representation or guarantee regarding the suitability of its products for any particular purpose, nor does onsemi assume any liability arising out of the application or use of any product or circuit, and specifically disclaims any and all liability, including without limitation special, consequential or incidental damages. onsemi does not convey any license under its patent rights nor the rights of others.

onsemi, **Onsemi**, and other names, marks, and brands are registered and/or common law trademarks of Semiconductor Components Industries, LLC dba "**onsemi**" or its affiliates and/or subsidiaries in the United States and/or other countries. **onsemi** owns the rights to a number of patents, trademarks, copyrights, trade secrets, and other intellectual property. A listing of **onsemi**'s product/patent coverage may be accessed at www.onsemi.com/site/pdf/Patent-Marking.pdf. **onsemi** reserves the right to make changes at any time to any products or information herein, without notice. The information herein is provided "as-is" and **onsemi** makes no warranty, representation or guarantee regarding the accuracy of the information, product features, availability, functionality, or suitability of its products for any particular purpose, nor does **onsemi** assume any liability arising out of the application or use of any product or circuit, and specifically disclaims any and all liability, including without limitation special, consequential or incidental damages. Buyer is responsible for its products and applications using **onsemi** products, including compliance with all laws, regulations and safety requirements or standards, regardless of any support or applications information provided by **onsemi**. "Typical" parameters which may be provided in **onsemi** data sheets and/or specifications can and do vary in different applications and actual performance may vary over time. All operating parameters, including "Typicals" must be validated for each customer application by customer's technical experts. **onsemi** does not convey any license under any of its intellectual property rights nor the rights of others. **onsemi** products are not designed, intended, or authorized for use as a critical component in life support systems or any FDA Class 3 medical devices or medical devices with a same or similar classification in a foreign jurisdiction or any devices intended for implantation in the human body. Should Buyer purchase or use **onsemi** products for any such unintended or unauthorized application, Buyer shall indemnify and hold **onsemi** and its officers, employees, subsidiaries, affiliates, and distributors harmless against all claims, costs, damages, and expenses, and reasonable attorney fees arising out of, directly or indirectly, any claim of personal injury or death associated with such unintended or unauthorized use, even if such claim alleges that **onsemi** was negligent regarding the design or manufacture of the part. **onsemi** is an Equal Opportunity/Affirmative Action Employer. This literature is subject to all applicable copyright laws and is not for resale in any manner.

ADDITIONAL INFORMATION

TECHNICAL PUBLICATIONS:

Technical Library: www.onsemi.com/design/resources/technical-documentation
onsemi Website: www.onsemi.com

ONLINE SUPPORT: www.onsemi.com/support

For additional information, please contact your local Sales Representative at www.onsemi.com/support/sales