

# NUP1105LT1G, SZNUP1105LT1G

## ESD Protection Diode

### Single Line CAN/LIN Bus Protector

The NUP1105L has been designed to protect LIN and single line CAN transceivers from ESD and other harmful transient voltage events. This device provides bidirectional protection for the data line with a single SOT-23 package, giving the system designer a low cost option for improving system reliability and meeting stringent EMI requirements.

#### Features

- SOT-23 Package Allows One Separate Bidirectional Configuration
- 350 W Peak Power Dissipation per Line (8 x 20  $\mu$ sec Waveform)
- Low Reverse Leakage Current (< 100 nA)
- IEC Compatibility:
  - IEC 61000-4-2 (ESD): Level 4
  - IEC 61000-4-4 (EFT): 40 A – 5/50 ns
  - IEC 61000-4-5 (Lighting) 8.0 A (8/20  $\mu$ s)
- ISO 7637-1, Nonrepetitive EMI Surge Pulse TBD
- ISO 7637-3, Repetitive Electrical Fast Transient (EFT) TBD
- EMI Surge Pulses
- Flammability Rating UL 94 V-0
- SZ Prefix for Automotive and Other Applications Requiring Unique Site and Control Change Requirements; AEC-Q101 Qualified and PPAP Capable
- These Devices are Pb-Free and are RoHS Compliant

#### Applications

- Automotive Electronics
  - ◆ LIN Bus
  - ◆ Single Line CAN
- Industrial Control Networks
  - ◆ Smart Distribution Systems (SDS<sup>®</sup>)
  - ◆ DeviceNet<sup>™</sup>



ON Semiconductor<sup>®</sup>

[www.onsemi.com](http://www.onsemi.com)

### SOT-23 BIDIRECTIONAL VOLTAGE SUPPRESSOR 350 W PEAK POWER

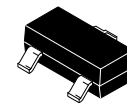

SOT-23  
CASE 318  
STYLE 27

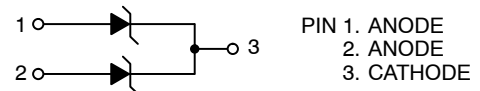

#### MARKING DIAGRAM

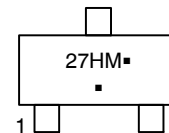

27H = Device Code  
M = Date Code  
▪ = Pb-Free Package

(Note: Microdot may be in either location)

#### ORDERING INFORMATION

Device	Package	Shipping <sup>†</sup>
NUP1105LT1G	SOT-23 (Pb-Free)	3,000 / Tape & Reel
SZNUP1105LT1G	SOT-23 (Pb-Free)	3,000 / Tape & Reel
NUP1105LT3G	SOT-23 (Pb-Free)	10,000 / Tape & Reel

<sup>†</sup>For information on tape and reel specifications, including part orientation and tape sizes, please refer to our Tape and Reel Packaging Specification Brochure, BRD8011/D.

# NUP1105LT1G, SZNUP1105LT1G

## MAXIMUM RATINGS (T<sub>J</sub> = 25°C, unless otherwise specified)

Symbol	Rating	Value	Unit
PPK	Peak Power Dissipation 8 x 20 μs Double Exponential Waveform (Note 1)	350	W
T <sub>J</sub>	Operating Junction Temperature Range	-55 to 150	°C
T <sub>J</sub>	Storage Temperature Range	-55 to 150	°C
T <sub>L</sub>	Lead Solder Temperature (10 s)	260	°C
ESD	Human Body model (HBM) Machine Model (MM) IEC 61000-4-2 Specification (Contact)	16 400 30	kV V kV

Stresses exceeding those listed in the Maximum Ratings table may damage the device. If any of these limits are exceeded, device functionality should not be assumed, damage may occur and reliability may be affected.

1. Non-repetitive current pulse per Figure 1.

## ELECTRICAL CHARACTERISTICS (T<sub>J</sub> = 25°C, unless otherwise specified)

Symbol	Parameter	Test Conditions	Min	Typ	Max	Unit
V <sub>RWM</sub>	Reverse Working Voltage	(Note 2)	24			V
V <sub>BR</sub>	Breakdown Voltage	I <sub>T</sub> = 1 mA (Note 3)	25.7		28.4	V
I <sub>R</sub>	Reverse Leakage Current	V <sub>RWM</sub> = 24 V		15	100	nA
V <sub>C</sub>	Clamping Voltage	I <sub>PP</sub> = 5 A (8 x 20 μs Waveform) (Note 4)			40	V
V <sub>C</sub>	Clamping Voltage	I <sub>PP</sub> = 8 A (8 x 20 μs Waveform) (Note 4)			44	V
I <sub>PP</sub>	Maximum Peak Pulse Current	8 x 20 μs Waveform (Note 4)			8.0	A
C <sub>J</sub>	Capacitance	V <sub>R</sub> = 0 V, f = 1 MHz (Anode to GND) V <sub>R</sub> = 0 V, f = 1 MHz (Anode to Anode)			60 30	pF

Product parametric performance is indicated in the Electrical Characteristics for the listed test conditions, unless otherwise noted. Product performance may not be indicated by the Electrical Characteristics if operated under different conditions.

2. Surge protection devices are normally selected according to the working peak reverse voltage (V<sub>RWM</sub>), which should be equal or greater than the DC or continuous peak operating voltage level.
3. V<sub>BR</sub> is measured at pulse test current I<sub>T</sub>.
4. Pulse waveform per Figure 1.
5. Include SZ-prefix devices where applicable.

# NUP1105LT1G, SZNUP1105LT1G

## TYPICAL PERFORMANCE CURVES

( $T_J = 25^\circ\text{C}$  unless otherwise noted)

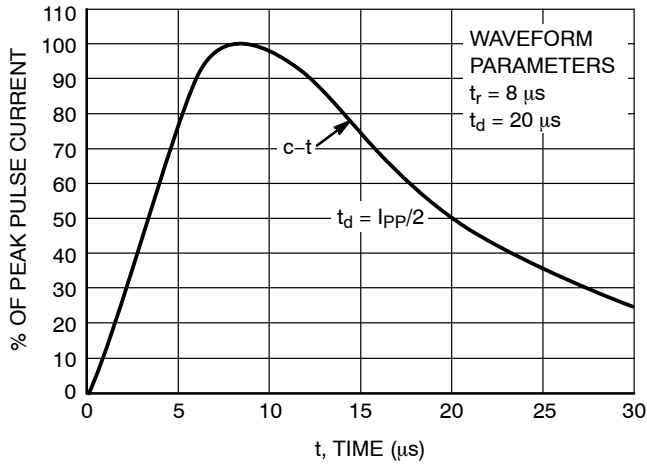

Figure 1. Pulse Waveform,  $8 \times 20 \mu\text{s}$

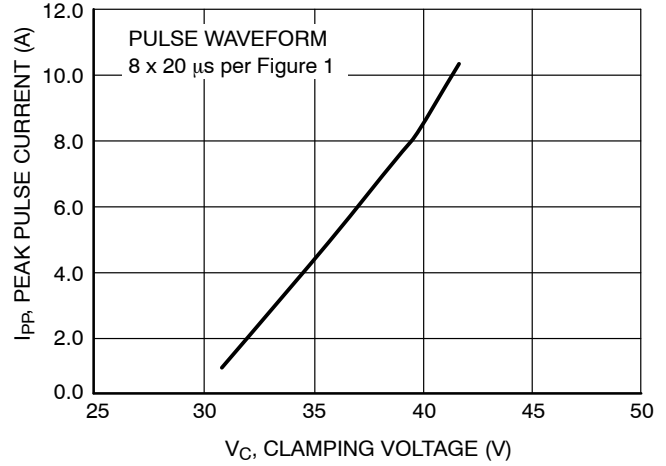

Figure 2. Clamping Voltage vs Peak Pulse Current

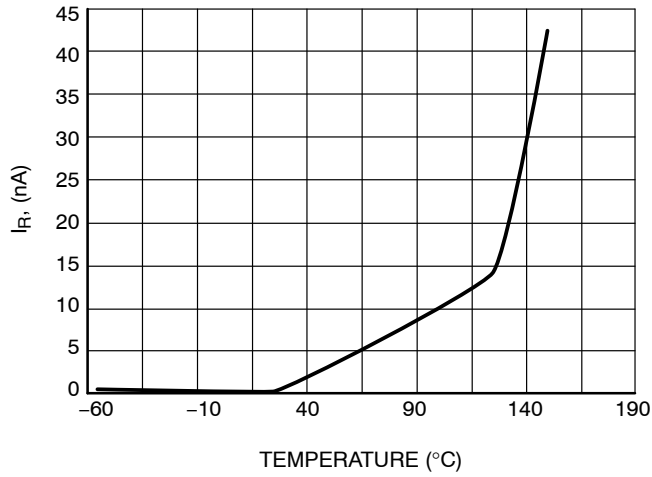

Figure 3. Typical Leakage vs. Temperature

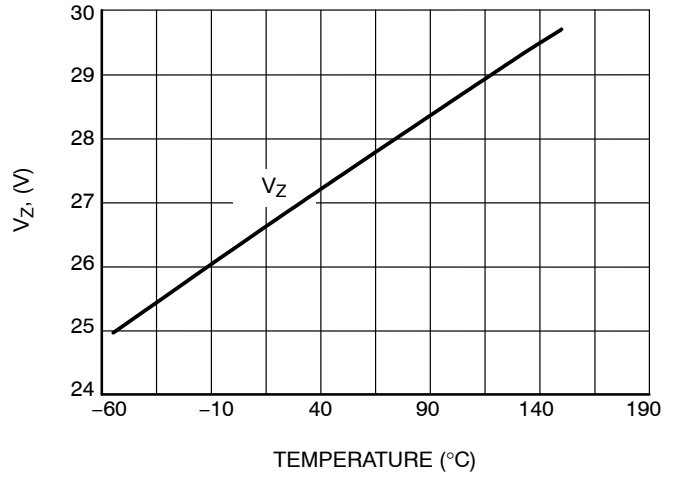

Figure 4. Typical  $V_Z$  @ 1.0 mA vs. Temperature

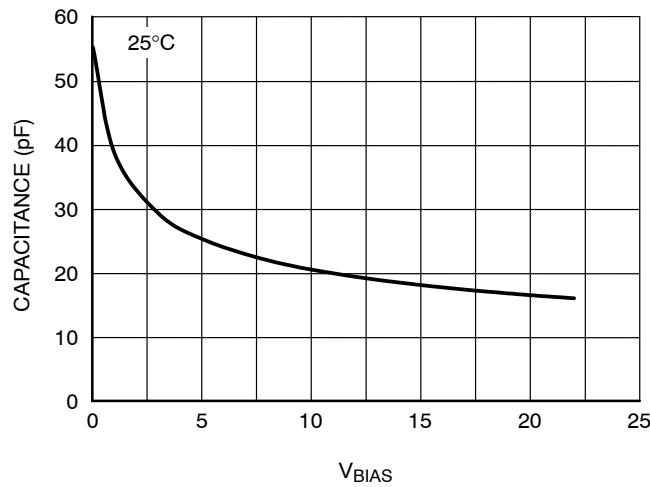

Figure 5. Capacitance vs.  $V_{BIAS}$

APPLICATIONS SECTION

The NUP1105L provides a surge protection solution for the LIN data communication bus. The NUP1105L is a dual bidirectional surge protection device in a compact SOT-23 package. This device is based on Zener technology that optimizes the active area of a PN junction to provide robust protection against transient EMI surge voltage and ESD. The NUP1105L has been tested to EMI and ESD levels that exceed the specifications of popular high speed LIN networks.

The NUP1105L device can be used to provide transient voltage suppression for a single data line CAN system. Figure 7 provides an example of a single data line CAN protection circuit.

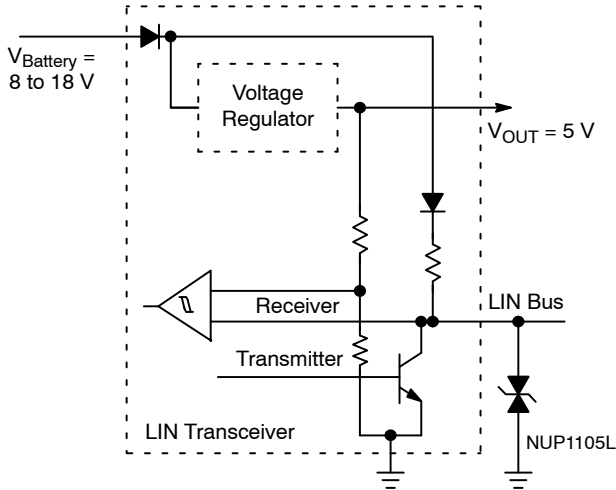

Figure 6. LIN Transceiver

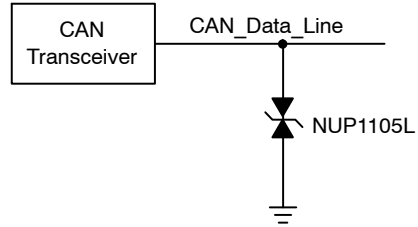

Figure 7. High-Speed and Fault Tolerant CAN Surge Protection Circuit

**onsemi**, **Onsemi**, and other names, marks, and brands are registered and/or common law trademarks of Semiconductor Components Industries, LLC dba "**onsemi**" or its affiliates and/or subsidiaries in the United States and/or other countries. **onsemi** owns the rights to a number of patents, trademarks, copyrights, trade secrets, and other intellectual property. A listing of **onsemi**'s product/patent coverage may be accessed at [www.onsemi.com/site/pdf/Patent-Marking.pdf](http://www.onsemi.com/site/pdf/Patent-Marking.pdf). **onsemi** reserves the right to make changes at any time to any products or information herein, without notice. The information herein is provided "as-is" and **onsemi** makes no warranty, representation or guarantee regarding the accuracy of the information, product features, availability, functionality, or suitability of its products for any particular purpose, nor does **onsemi** assume any liability arising out of the application or use of any product or circuit, and specifically disclaims any and all liability, including without limitation special, consequential or incidental damages. Buyer is responsible for its products and applications using **onsemi** products, including compliance with all laws, regulations and safety requirements or standards, regardless of any support or applications information provided by **onsemi**. "Typical" parameters which may be provided in **onsemi** data sheets and/or specifications can and do vary in different applications and actual performance may vary over time. All operating parameters, including "Typicals" must be validated for each customer application by customer's technical experts. **onsemi** does not convey any license under any of its intellectual property rights nor the rights of others. **onsemi** products are not designed, intended, or authorized for use as a critical component in life support systems or any FDA Class 3 medical devices or medical devices with a same or similar classification in a foreign jurisdiction or any devices intended for implantation in the human body. Should Buyer purchase or use **onsemi** products for any such unintended or unauthorized application, Buyer shall indemnify and hold **onsemi** and its officers, employees, subsidiaries, affiliates, and distributors harmless against all claims, costs, damages, and expenses, and reasonable attorney fees arising out of, directly or indirectly, any claim of personal injury or death associated with such unintended or unauthorized use, even if such claim alleges that **onsemi** was negligent regarding the design or manufacture of the part. **onsemi** is an Equal Opportunity/Affirmative Action Employer. This literature is subject to all applicable copyright laws and is not for resale in any manner.

## ADDITIONAL INFORMATION

### TECHNICAL PUBLICATIONS:

Technical Library: [www.onsemi.com/design/resources/technical-documentation](http://www.onsemi.com/design/resources/technical-documentation)  
onsemi Website: [www.onsemi.com](http://www.onsemi.com)

### ONLINE SUPPORT: [www.onsemi.com/support](http://www.onsemi.com/support)

For additional information, please contact your local Sales Representative at [www.onsemi.com/support/sales](http://www.onsemi.com/support/sales)