

# MC74VHC08

## Quad 2-Input AND Gate

The MC74VHC08 is an advanced high speed CMOS 2-input AND gate fabricated with silicon gate CMOS technology. It achieves high speed operation similar to equivalent Bipolar Schottky TTL while maintaining CMOS low power dissipation.

The internal circuit is composed of three stages, including a buffer output which provides high noise immunity and stable output. The inputs tolerate voltages up to 7.0 V, allowing the interface of 5.0 V systems to 3.0 V systems.

### Features

- High Speed:  $t_{PD} = 4.3$  ns (Typ) at  $V_{CC} = 5.0$  V
- Low Power Dissipation:  $I_{CC} = 2.0$   $\mu$ A (Max) at  $T_A = 25^\circ$ C
- High Noise Immunity:  $V_{NIH} = V_{NIL} = 28\%$   $V_{CC}$
- Power Down Protection Provided on Inputs
- Balanced Propagation Delays
- Designed for 2.0 V to 5.5 V Operating Range
- Low Noise:  $V_{OLP} = 0.8$  V (Max)
- Pin and Function Compatible with Other Standard Logic Families
- Latchup Performance Exceeds 300 mA
- ESD Performance:
  - Human Body Model > 2000 V;
  - Machine Model > 200 V
- Chip Complexity: 24 FETs or 6 Equivalent Gates
- NLV Prefix for Automotive and Other Applications Requiring Unique Site and Control Change Requirements; AEC-Q100 Qualified and PPAP Capable
- These Devices are Pb-Free and are RoHS Compliant

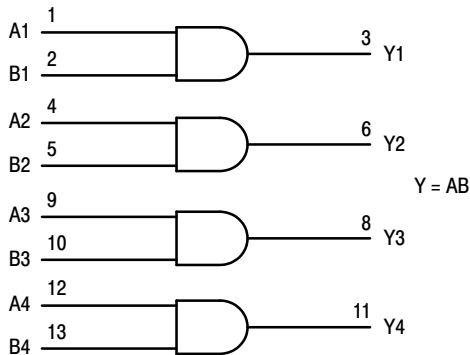

Figure 1. Logic Diagram

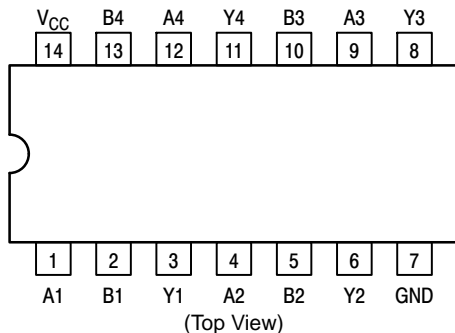

Figure 2. Pinout: 14-Lead Packages



ON Semiconductor®

[www.onsemi.com](http://www.onsemi.com)

### MARKING DIAGRAMS

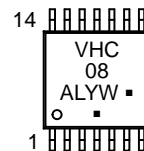
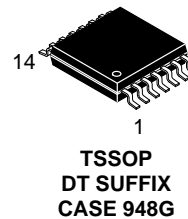
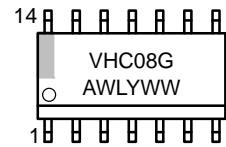

- A = Assembly Location
- WL, L = Wafer Lot
- Y = Year
- WW, W = Work Week
- G or ■ = Pb-Free Package

(Note: Microdot may be in either location)

### FUNCTION TABLE

| Inputs |   | Output |
|--------|---|--------|
| A      | B | Y      |
| L      | L | L      |
| L      | H | L      |
| H      | L | L      |
| H      | H | H      |

### ORDERING INFORMATION

See detailed ordering and shipping information in the package dimensions section on page 3 of this data sheet.

# MC74VHC08

## MAXIMUM RATINGS

| Symbol           | Parameter  | Value                        | Unit |
|------------------|--|------------------------------|------|
| V <sub>CC</sub>  | DC Supply Voltage  | -0.5 to +7.0                 | V    |
| V <sub>in</sub>  | DC Input Voltage   | -0.5 to +7.0                 | V    |
| V <sub>out</sub> | DC Output Voltage  | -0.5 to V <sub>CC</sub> +0.5 | V    |
| I <sub>IK</sub>  | Input Diode Current  | -20                          | mA   |
| I <sub>OK</sub>  | Output Diode Current   | ±20                          | mA   |
| I <sub>out</sub> | DC Output Current, per Pin   | ±25                          | mA   |
| I <sub>CC</sub>  | DC Supply Current, V <sub>CC</sub> and GND Pins                    | ±50                          | mA   |
| P <sub>D</sub>   | Power Dissipation in Still Air,<br>SOIC Package†<br>TSSOP Package† | 500<br>450                   | mW   |
| T <sub>stg</sub> | Storage Temperature  | -65 to +150                  | °C   |

This device contains protection circuitry to guard against damage due to high static voltages or electric fields. However, precautions must be taken to avoid applications of any voltage higher than maximum rated voltages to this high-impedance circuit. For proper operation, V<sub>in</sub> and V<sub>out</sub> should be constrained to the range GND ≤ (V<sub>in</sub> or V<sub>out</sub>) ≤ V<sub>CC</sub>. Unused inputs must always be tied to an appropriate logic voltage level (e.g., either GND or V<sub>CC</sub>). Unused outputs must be left open.

Stresses exceeding those listed in the Maximum Ratings table may damage the device. If any of these limits are exceeded, device functionality should not be assumed, damage may occur and reliability may be affected.

†Derating – SOIC Package: - 7 mW/°C from 65° to 125°C  
TSSOP Package: - 6.1 mW/°C from 65° to 125°C

## RECOMMENDED OPERATING CONDITIONS

| Symbol                          | Parameter  | Min    | Max             | Unit |
|---------------------------------|--|--------|-----------------|------|
| V <sub>CC</sub>                 | DC Supply Voltage  | 2.0    | 5.5             | V    |
| V <sub>in</sub>                 | DC Input Voltage   | 0      | 5.5             | V    |
| V <sub>out</sub>                | DC Output Voltage  | 0      | V <sub>CC</sub> | V    |
| T <sub>A</sub>                  | Operating Temperature  | -55    | +125            | °C   |
| t <sub>r</sub> , t <sub>f</sub> | Input Rise and Fall Time<br>V <sub>CC</sub> = 3.3 V ±0.3 V<br>V <sub>CC</sub> = 5.0 V ±0.5 V | 0<br>0 | 100<br>20       | ns/V |

Functional operation above the stresses listed in the Recommended Operating Ranges is not implied. Extended exposure to stresses beyond the Recommended Operating Ranges limits may affect device reliability.

## DC ELECTRICAL CHARACTERISTICS

| Symbol          | Parameter                         | Test Conditions  | V <sub>CC</sub><br>V | T <sub>A</sub> = 25°C         |                   |                               | T <sub>A</sub> = -55°C to 125°C |                               | Unit |
|-----------------|-----------------------------------|--|----------------------|-------------------------------|-------------------|-------------------------------|---------------------------------|-------------------------------|------|
|                 |                                   |  |                      | Min                           | Typ               | Max                           | Min                             | Max                           |      |
| V <sub>IH</sub> | Minimum High-Level Input Voltage  |  | 2.0<br>3.0 to 5.5    | 1.50<br>V <sub>CC</sub> x 0.7 |                   |                               | 1.50<br>V <sub>CC</sub> x 0.7   |                               | V    |
| V <sub>IL</sub> | Maximum Low-Level Input Voltage   |  | 2.0<br>3.0 to 5.5    |                               |                   | 0.50<br>V <sub>CC</sub> x 0.3 |                                 | 0.50<br>V <sub>CC</sub> x 0.3 | V    |
| V <sub>OH</sub> | Minimum High-Level Output Voltage | V <sub>in</sub> = V <sub>IH</sub> or V <sub>IL</sub><br>I <sub>OH</sub> = -50 μA                               | 2.0<br>3.0<br>4.5    | 1.9<br>2.9<br>4.4             | 2.0<br>3.0<br>4.5 |                               | 1.9<br>2.9<br>4.4               |                               | V    |
|                 |                                   | V <sub>in</sub> = V <sub>IH</sub> or V <sub>IL</sub><br>I <sub>OH</sub> = -4.0 mA<br>I <sub>OH</sub> = -8.0 mA | 3.0<br>4.5           | 2.58<br>3.94                  |                   |                               | 2.48<br>3.80                    |                               | V    |
| V <sub>OL</sub> | Maximum Low-Level Output Voltage  | V <sub>in</sub> = V <sub>IH</sub> or V <sub>IL</sub><br>I <sub>OL</sub> = 50 μA                                | 2.0<br>3.0<br>4.5    |                               | 0.0<br>0.0<br>0.0 | 0.1<br>0.1<br>0.1             |                                 | 0.1<br>0.1<br>0.1             | V    |
|                 |                                   | V <sub>in</sub> = V <sub>IH</sub> or V <sub>IL</sub><br>I <sub>OL</sub> = 4.0 mA<br>I <sub>OL</sub> = 8.0 mA   | 3.0<br>4.5           |                               |                   | 0.36<br>0.36                  |                                 | 0.44<br>0.44                  | V    |
| I <sub>in</sub> | Maximum Input Leakage Current     | V <sub>in</sub> = 5.5 V or GND   | 0 to 5.5             |                               |                   | ±0.1                          |                                 | ±1.0                          | μA   |
| I <sub>CC</sub> | Maximum Quiescent Supply Current  | V <sub>in</sub> = V <sub>CC</sub> or GND   | 5.5                  |                               |                   | 2.0                           |                                 | 20.0                          | μA   |

Product parametric performance is indicated in the Electrical Characteristics for the listed test conditions, unless otherwise noted. Product performance may not be indicated by the Electrical Characteristics if operated under different conditions.

# MC74VHC08

## AC ELECTRICAL CHARACTERISTICS (Input $t_r = t_f = 3.0$ ns)

| Symbol                   | Parameter                              | Test Conditions  | $T_A = 25^\circ\text{C}$ |            |             | $T_A = -55^\circ\text{C to } 125^\circ\text{C}$ |              | Unit |
|--------------------------|--|--|--------------------------|------------|-------------|---|--------------|------|
|                          |  |  | Min                      | Typ        | Max         | Min   | Max          |      |
| $t_{PLH}$ ,<br>$t_{PHL}$ | Maximum Propagation Delay, A or B to Y | $V_{CC} = 3.3 \pm 0.3$ V<br>$C_L = 15$ pF<br>$C_L = 50$ pF |                          | 6.2<br>8.7 | 8.8<br>12.3 | 1.0<br>1.0                                      | 10.5<br>14.0 | ns   |
|                          |  | $V_{CC} = 5.0 \pm 0.5$ V<br>$C_L = 15$ pF<br>$C_L = 50$ pF |                          | 4.3<br>5.8 | 5.9<br>7.9  | 1.0<br>1.0                                      | 7.0<br>9.0   |      |
| $C_{in}$                 | Maximum Input Capacitance              |  |                          | 4<br>10    |             |   | 10           | pF   |

| $C_{PD}$ | Power Dissipation Capacitance (Note 1) | Typical @ $25^\circ\text{C}$ , $V_{CC} = 5.0$ V |  | pF |
|----------|--|---|--|----|
|          |  | 18  |  |    |
|          |  |   |  |    |

1.  $C_{PD}$  is defined as the value of the internal equivalent capacitance which is calculated from the operating current consumption without load. Average operating current can be obtained by the equation:  $I_{CC(OPR)} = C_{PD} \cdot V_{CC} \cdot f_{in} + I_{CC}/4$  (per gate).  $C_{PD}$  is used to determine the no-load dynamic power consumption;  $P_D = C_{PD} \cdot V_{CC}^2 \cdot f_{in} + I_{CC} \cdot V_{CC}$ .

## NOISE CHARACTERISTICS (Input $t_r = t_f = 3.0$ ns, $C_L = 50$ pF, $V_{CC} = 5.0$ V)

| Symbol    | Characteristic                           | $T_A = 25^\circ\text{C}$ |      | Unit |
|-----------|--|--------------------------|------|------|
|           |  | Typ                      | Max  |      |
| $V_{OLP}$ | Quiet Output Maximum Dynamic $V_{OL}$    | 0.3                      | 0.8  | V    |
| $V_{OLV}$ | Quiet Output Minimum Dynamic $V_{OL}$    | -0.3                     | -0.8 | V    |
| $V_{IHD}$ | Minimum High Level Dynamic Input Voltage |                          | 3.5  | V    |
| $V_{ILD}$ | Maximum Low Level Dynamic Input Voltage  |                          | 1.5  | V    |

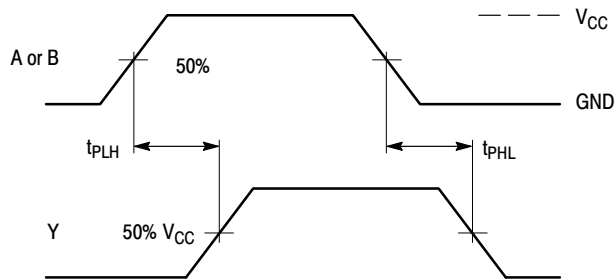
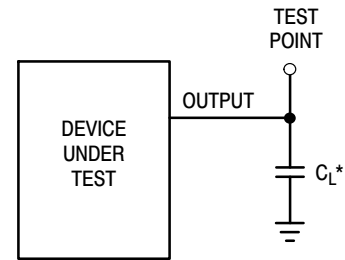

Figure 3. Switching Waveforms



\*Includes all probe and jig capacitance

Figure 4. Test Circuit

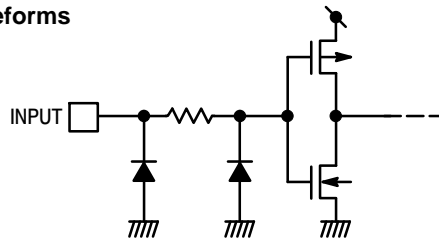

Figure 5. Input Equivalent Circuit

## ORDERING INFORMATION

| Device          | Package            | Shipping <sup>†</sup>    |
|-----------------|--------------------|--------------------------|
| MC74VHC08DR2G   | SOIC-14 (Pb-Free)  | 2500 Units / Tape & Reel |
| MC74VHC08DTR2G  | TSSOP-14 (Pb-Free) | 2500 Units / Tape & Reel |
| NLV74VHC08DTRG* |                    |                          |

<sup>†</sup>For information on tape and reel specifications, including part orientation and tape sizes, please refer to our Tape and Reel Packaging Specifications Brochure, BRD8011/D.

\*NLV Prefix for Automotive and Other Applications Requiring Unique Site and Control Change Requirements; AEC-Q100 Qualified and PPAP Capable

# MECHANICAL CASE OUTLINE PACKAGE DIMENSIONS



SCALE 1:1

SOIC-14 NB  
CASE 751A-03  
ISSUE L

DATE 03 FEB 2016



NOTES:

1. DIMENSIONING AND TOLERANCING PER ASME Y14.5M, 1994.
2. CONTROLLING DIMENSION: MILLIMETERS.
3. DIMENSION b DOES NOT INCLUDE DAMBAR PROTRUSION. ALLOWABLE PROTRUSION SHALL BE 0.13 TOTAL IN EXCESS OF AT MAXIMUM MATERIAL CONDITION.
4. DIMENSIONS D AND E DO NOT INCLUDE MOLD PROTRUSIONS.
5. MAXIMUM MOLD PROTRUSION 0.15 PER SIDE.

| DIM | MILLIMETERS |      | INCHES    |       |
|-----|-------------|------|-----------|-------|
|     | MIN         | MAX  | MIN       | MAX   |
| A   | 1.35        | 1.75 | 0.054     | 0.068 |
| A1  | 0.10        | 0.25 | 0.004     | 0.010 |
| A3  | 0.19        | 0.25 | 0.008     | 0.010 |
| b   | 0.35        | 0.49 | 0.014     | 0.019 |
| D   | 8.55        | 8.75 | 0.337     | 0.344 |
| E   | 3.80        | 4.00 | 0.150     | 0.157 |
| e   | 1.27 BSC    |      | 0.050 BSC |       |
| H   | 5.80        | 6.20 | 0.228     | 0.244 |
| h   | 0.25        | 0.50 | 0.010     | 0.019 |
| L   | 0.40        | 1.25 | 0.016     | 0.049 |
| M   | 0°          | 7°   | 0°        | 7°    |

SOLDERING FOOTPRINT\*

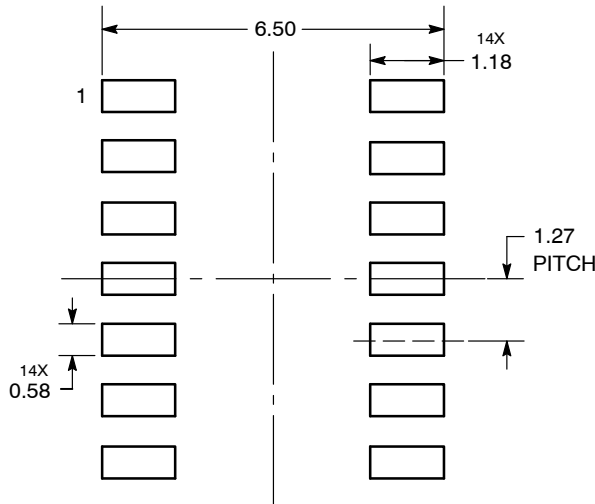

DIMENSIONS: MILLIMETERS

\*For additional information on our Pb-Free strategy and soldering details, please download the ON Semiconductor Soldering and Mounting Techniques Reference Manual, SOLDERRM/D.

GENERIC MARKING DIAGRAM\*



- XXXXXX = Specific Device Code
- A = Assembly Location
- WL = Wafer Lot
- Y = Year
- WW = Work Week
- G = Pb-Free Package

\*This information is generic. Please refer to device data sheet for actual part marking. Pb-Free indicator, "G" or microdot "▪", may or may not be present. Some products may not follow the Generic Marking.

STYLES ON PAGE 2

|                  |             |  |
|------------------|-------------|--|
| DOCUMENT NUMBER: | 98ASB42565B | Electronic versions are uncontrolled except when accessed directly from the Document Repository. Printed versions are uncontrolled except when stamped "CONTROLLED COPY" in red. |
| DESCRIPTION:     | SOIC-14 NB  | PAGE 1 OF 2  |

onsemi and ONSEMI are trademarks of Semiconductor Components Industries, LLC dba onsemi or its subsidiaries in the United States and/or other countries. onsemi reserves the right to make changes without further notice to any products herein. onsemi makes no warranty, representation or guarantee regarding the suitability of its products for any particular purpose, nor does onsemi assume any liability arising out of the application or use of any product or circuit, and specifically disclaims any and all liability, including without limitation special, consequential or incidental damages. onsemi does not convey any license under its patent rights nor the rights of others.

**SOIC-14**  
**CASE 751A-03**  
**ISSUE L**

DATE 03 FEB 2016

STYLE 1:  
 PIN 1. COMMON CATHODE  
 2. ANODE/CATHODE  
 3. ANODE/CATHODE  
 4. NO CONNECTION  
 5. ANODE/CATHODE  
 6. NO CONNECTION  
 7. ANODE/CATHODE  
 8. ANODE/CATHODE  
 9. ANODE/CATHODE  
 10. NO CONNECTION  
 11. ANODE/CATHODE  
 12. ANODE/CATHODE  
 13. NO CONNECTION  
 14. COMMON ANODE

STYLE 2:  
 CANCELLED

STYLE 3:  
 PIN 1. NO CONNECTION  
 2. ANODE  
 3. ANODE  
 4. NO CONNECTION  
 5. ANODE  
 6. NO CONNECTION  
 7. ANODE  
 8. ANODE  
 9. ANODE  
 10. NO CONNECTION  
 11. ANODE  
 12. ANODE  
 13. NO CONNECTION  
 14. COMMON CATHODE

STYLE 4:  
 PIN 1. NO CONNECTION  
 2. CATHODE  
 3. CATHODE  
 4. NO CONNECTION  
 5. CATHODE  
 6. NO CONNECTION  
 7. CATHODE  
 8. CATHODE  
 9. CATHODE  
 10. NO CONNECTION  
 11. CATHODE  
 12. CATHODE  
 13. NO CONNECTION  
 14. COMMON ANODE

STYLE 5:  
 PIN 1. COMMON CATHODE  
 2. ANODE/CATHODE  
 3. ANODE/CATHODE  
 4. ANODE/CATHODE  
 5. ANODE/CATHODE  
 6. NO CONNECTION  
 7. COMMON ANODE  
 8. COMMON CATHODE  
 9. ANODE/CATHODE  
 10. ANODE/CATHODE  
 11. ANODE/CATHODE  
 12. ANODE/CATHODE  
 13. NO CONNECTION  
 14. COMMON ANODE

STYLE 6:  
 PIN 1. CATHODE  
 2. CATHODE  
 3. CATHODE  
 4. CATHODE  
 5. CATHODE  
 6. CATHODE  
 7. CATHODE  
 8. ANODE  
 9. ANODE  
 10. ANODE  
 11. ANODE  
 12. ANODE  
 13. ANODE  
 14. ANODE

STYLE 7:  
 PIN 1. ANODE/CATHODE  
 2. COMMON ANODE  
 3. COMMON CATHODE  
 4. ANODE/CATHODE  
 5. ANODE/CATHODE  
 6. ANODE/CATHODE  
 7. ANODE/CATHODE  
 8. ANODE/CATHODE  
 9. ANODE/CATHODE  
 10. ANODE/CATHODE  
 11. COMMON CATHODE  
 12. COMMON ANODE  
 13. ANODE/CATHODE  
 14. ANODE/CATHODE

STYLE 8:  
 PIN 1. COMMON CATHODE  
 2. ANODE/CATHODE  
 3. ANODE/CATHODE  
 4. NO CONNECTION  
 5. ANODE/CATHODE  
 6. ANODE/CATHODE  
 7. COMMON ANODE  
 8. COMMON ANODE  
 9. ANODE/CATHODE  
 10. ANODE/CATHODE  
 11. NO CONNECTION  
 12. ANODE/CATHODE  
 13. ANODE/CATHODE  
 14. COMMON CATHODE

|                         |                    |   |
|-------------------------|--------------------|---|
| <b>DOCUMENT NUMBER:</b> | <b>98ASB42565B</b> | Electronic versions are uncontrolled except when accessed directly from the Document Repository.<br>Printed versions are uncontrolled except when stamped "CONTROLLED COPY" in red. |
| <b>DESCRIPTION:</b>     | <b>SOIC-14 NB</b>  | <b>PAGE 2 OF 2</b>  |

**onsemi** and **ONSEMI** are trademarks of Semiconductor Components Industries, LLC dba **onsemi** or its subsidiaries in the United States and/or other countries. **onsemi** reserves the right to make changes without further notice to any products herein. **onsemi** makes no warranty, representation or guarantee regarding the suitability of its products for any particular purpose, nor does **onsemi** assume any liability arising out of the application or use of any product or circuit, and specifically disclaims any and all liability, including without limitation special, consequential or incidental damages. **onsemi** does not convey any license under its patent rights nor the rights of others.

**onsemi**, **Onsemi**, and other names, marks, and brands are registered and/or common law trademarks of Semiconductor Components Industries, LLC dba "**onsemi**" or its affiliates and/or subsidiaries in the United States and/or other countries. **onsemi** owns the rights to a number of patents, trademarks, copyrights, trade secrets, and other intellectual property. A listing of **onsemi**'s product/patent coverage may be accessed at [www.onsemi.com/site/pdf/Patent-Marking.pdf](http://www.onsemi.com/site/pdf/Patent-Marking.pdf). **onsemi** reserves the right to make changes at any time to any products or information herein, without notice. The information herein is provided "as-is" and **onsemi** makes no warranty, representation or guarantee regarding the accuracy of the information, product features, availability, functionality, or suitability of its products for any particular purpose, nor does **onsemi** assume any liability arising out of the application or use of any product or circuit, and specifically disclaims any and all liability, including without limitation special, consequential or incidental damages. Buyer is responsible for its products and applications using **onsemi** products, including compliance with all laws, regulations and safety requirements or standards, regardless of any support or applications information provided by **onsemi**. "Typical" parameters which may be provided in **onsemi** data sheets and/or specifications can and do vary in different applications and actual performance may vary over time. All operating parameters, including "Typicals" must be validated for each customer application by customer's technical experts. **onsemi** does not convey any license under any of its intellectual property rights nor the rights of others. **onsemi** products are not designed, intended, or authorized for use as a critical component in life support systems or any FDA Class 3 medical devices or medical devices with a same or similar classification in a foreign jurisdiction or any devices intended for implantation in the human body. Should Buyer purchase or use **onsemi** products for any such unintended or unauthorized application, Buyer shall indemnify and hold **onsemi** and its officers, employees, subsidiaries, affiliates, and distributors harmless against all claims, costs, damages, and expenses, and reasonable attorney fees arising out of, directly or indirectly, any claim of personal injury or death associated with such unintended or unauthorized use, even if such claim alleges that **onsemi** was negligent regarding the design or manufacture of the part. **onsemi** is an Equal Opportunity/Affirmative Action Employer. This literature is subject to all applicable copyright laws and is not for resale in any manner.

## ADDITIONAL INFORMATION

### TECHNICAL PUBLICATIONS:

Technical Library: [www.onsemi.com/design/resources/technical-documentation](http://www.onsemi.com/design/resources/technical-documentation)  
onsemi Website: [www.onsemi.com](http://www.onsemi.com)

### ONLINE SUPPORT: [www.onsemi.com/support](http://www.onsemi.com/support)

For additional information, please contact your local Sales Representative at [www.onsemi.com/support/sales](http://www.onsemi.com/support/sales)