

## Phase Control Thyristors (Stud Version), 110 A



TO-94 (TO-209AC)

### FEATURES

- High current and high surge ratings
- Hermetic ceramic housing
- Designed and qualified for industrial level
- Material categorization: for definitions of compliance please see [www.vishay.com/doc?99912](http://www.vishay.com/doc?99912)

**RoHS**  
COMPLIANT

### TYPICAL APPLICATIONS

- DC motor controls
- Controlled DC power supplies
- AC controllers

### PRIMARY CHARACTERISTICS

$I_{T(AV)}$	110 A
$V_{DRM}/V_{RRM}$	400 V, 800 V, 1200 V
$V_{TM}$	1.57 V
$I_{GT}$	80 mA
$T_J$	-40 °C to +140 °C
Package	TO-94 (TO-209AC)
Circuit configuration	Single SCR

### MAJOR RATINGS AND CHARACTERISTICS

PARAMETER	TEST CONDITIONS	VALUES	UNITS
$I_{T(AV)}$		110	A
	$T_C$	90	°C
$I_{T(RMS)}$		172	A
$I_{TSM}$	50 Hz	2080	
	60 Hz	2180	
$I^2t$	50 Hz	21.7	kA <sup>2</sup> s
	60 Hz	19.8	
$V_{DRM}/V_{RRM}$		400 to 1200	V
$t_q$	Typical	110	μs
$T_J$		-40 to +140	°C

### ELECTRICAL SPECIFICATIONS

#### VOLTAGE RATINGS

TYPE NUMBER	VOLTAGE CODE	$V_{DRM}/V_{RRM}$ , MAXIMUM REPETITIVE PEAK AND OFF-STATE VOLTAGE V	$V_{RSM}$ , MAXIMUM NON-REPETITIVE PEAK VOLTAGE V	$I_{DRM}/I_{RRM}$ MAXIMUM AT $T_J = T_J$ MAXIMUM mA
VS-110RKI VS-111RKI	40	400	500	20
	80	800	900	
	120	1200	1300	



**ABSOLUTE MAXIMUM RATINGS**

PARAMETER	SYMBOL	TEST CONDITIONS	VALUES	UNITS
Maximum average on-state current at case temperature	$I_{T(AV)}$	180° conduction, half sine wave	110	A
			90	°C
Maximum RMS on-state current	$I_{T(RMS)}$	DC at 83 °C case temperature	172	
Maximum peak, one-cycle non-repetitive surge current	$I_{TSM}$	t = 10 ms	2080	A
		t = 8.3 ms	2180	
		t = 10 ms	1750	
		t = 8.3 ms	1830	
Maximum $I^2t$ for fusing	$I^2t$	t = 10 ms	21.7	kA <sup>2</sup> s
		t = 8.3 ms	19.8	
		t = 10 ms	15.3	
		t = 8.3 ms	14.0	
Maximum $I^2\sqrt{t}$ for fusing	$I^2\sqrt{t}$	t = 0.1 ms to 10 ms, no voltage reapplied	217	kA <sup>2</sup> √s
Low level value of threshold voltage	$V_{T(TO)1}$	(16.7 % $\times \pi \times I_{T(AV)} < I < \pi \times I_{T(AV)}$ ), $T_J = T_J$ maximum	0.82	V
High level value of threshold voltage	$V_{T(TO)2}$	( $I > \pi \times I_{T(AV)}$ ), $T_J = T_J$ maximum	1.02	
Low level value of on-state slope resistance	$r_{t1}$	(16.7 % $\times \pi \times I_{T(AV)} < I < \pi \times I_{T(AV)}$ ), $T_J = T_J$ maximum	2.16	mΩ
High level value of on-state slope resistance	$r_{t2}$	( $I > \pi \times I_{T(AV)}$ ), $T_J = T_J$ maximum	1.70	
Maximum on-state voltage	$V_{TM}$	$I_{pk} = 350$ A, $T_J = T_J$ maximum, $t_p = 10$ ms sine pulse	1.57	V
Maximum holding current	$I_H$	$T_J = 25$ °C, anode supply 6 V resistive load	200	mA
Typical latching current	$I_L$		400	

**SWITCHING**

PARAMETER	SYMBOL	TEST CONDITIONS	VALUES	UNITS
Maximum non-repetitive rate of rise of turned-on current	$dI/dt$	Gate drive 20 V, 20 Ω, $t_r \leq 1$ μs $T_J = T_J$ maximum, anode voltage $\leq 80$ % $V_{DRM}$	300	A/μs
Typical delay time	$t_d$	Gate current 1 A, $dI_g/dt = 1$ A/μs $V_d = 0.67$ % $V_{DRM}$ , $T_J = 25$ °C	1	μs
Typical turn-off time	$t_q$	$I_{TM} = 50$ A, $T_J = T_J$ maximum, $dI/dt = -5$ A/μs $V_R = 50$ V, $dV/dt = 20$ V/μs, gate 0 V 25 Ω	110	

**BLOCKING**

PARAMETER	SYMBOL	TEST CONDITIONS	VALUES	UNITS
Maximum critical rate of rise of off-state voltage	$dV/dt$	$T_J = T_J$ maximum linear to 80 % rated $V_{DRM}$	500	V/μs
Maximum peak reverse and off-state leakage current	$I_{RRM}, I_{DRM}$	$T_J = T_J$ maximum rated $V_{DRM}/V_{RRM}$ applied	20	mA





TRIGGERING						
PARAMETER	SYMBOL	TEST CONDITIONS		VALUES		UNITS
				TYP.	MAX.	
Maximum peak gate power	P <sub>GM</sub>	T <sub>J</sub> = T <sub>J</sub> maximum, t <sub>p</sub> ≤ 5 ms		12		W
Maximum average gate power	P <sub>G(AV)</sub>	T <sub>J</sub> = T <sub>J</sub> maximum, f = 50 Hz, d% = 50		3.0		
Maximum peak positive gate current	I <sub>GM</sub>	T <sub>J</sub> = T <sub>J</sub> maximum, t <sub>p</sub> ≤ 5 ms		3.0		A
Maximum peak positive gate voltage	+ V <sub>GM</sub>			20		V
Maximum peak negative gate voltage	- V <sub>GM</sub>			10		
DC gate current required to trigger	I <sub>GT</sub>	T <sub>J</sub> = - 40 °C	Maximum required gate trigger/current/voltage are the lowest value which will trigger all units 12 V anode to cathode applied	180	-	mA
		T <sub>J</sub> = 25 °C		80	120	
		T <sub>J</sub> = 140 °C		40	-	
DC gate voltage required to trigger	V <sub>GT</sub>	T <sub>J</sub> = - 40 °C		2.5	-	V
		T <sub>J</sub> = 25 °C		1.6	2	
		T <sub>J</sub> = 140 °C		1	-	
DC gate current not to trigger	I <sub>GD</sub>	T <sub>J</sub> = T <sub>J</sub> maximum	Maximum gate current/ voltage not to trigger is the maximum value which will not trigger any unit with rated V <sub>DRM</sub> anode to cathode applied	6.0		mA
DC gate voltage not to trigger	V <sub>GD</sub>			0.25		V

THERMAL AND MECHANICAL SPECIFICATIONS					
PARAMETER	SYMBOL	TEST CONDITIONS	VALUES	UNITS	
Maximum operating junction temperature range	$T_J$		-40 to +140		°C
Maximum storage temperature range	$T_{Stg}$		-40 to +150		
Maximum thermal resistance, junction to case	$R_{thJC}$	DC operation	0.27		K/W
Maximum thermal resistance, case to heatsink	$R_{thCS}$	Mounting surface, smooth, flat and greased	0.1		
Mounting torque, $\pm 10$ %		Non-lubricated threads	15.5 (137)		N · m (lbf · in)
		Lubricated threads	14 (120)		
Approximate weight			130		g
Case style		See dimensions - link at the end of datasheet	TO-94 (TO-209AC)		

$\Delta R_{thJC}$ CONDUCTION				
CONDUCTION ANGLE	SINUSOIDAL CONDUCTION	RECTANGULAR CONDUCTION	TEST CONDITIONS	UNITS
180°	0.043	0.031	$T_J = T_J$ maximum	K/W
120°	0.052	0.053		
90°	0.066	0.071		
60°	0.096	0.101		
30°	0.167	0.169		

**Note**

- The table above shows the increment of thermal resistance  $R_{thJC}$  when devices operate at different conduction angles than DC



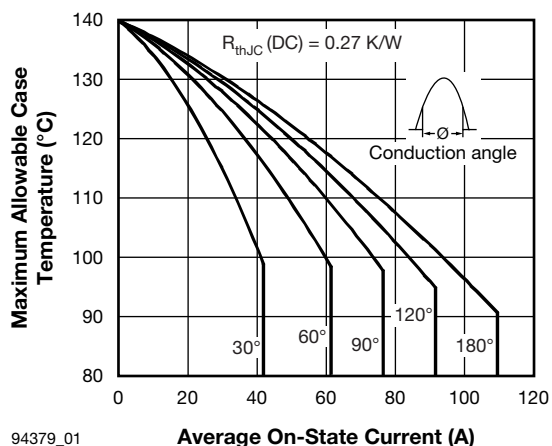

Fig. 1 - Current Ratings Characteristics

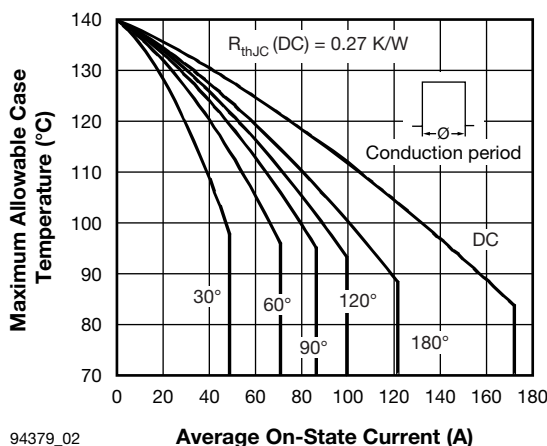

Fig. 2 - Current Ratings Characteristics

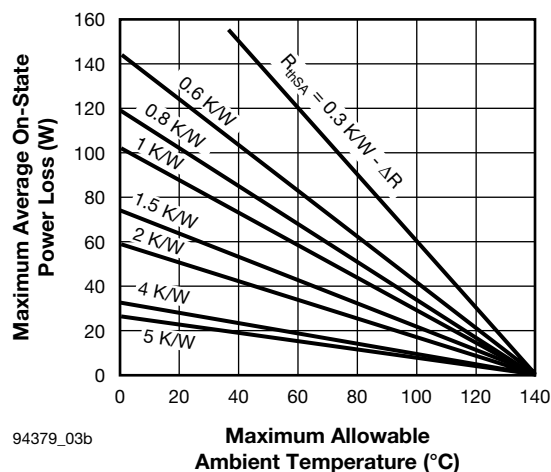
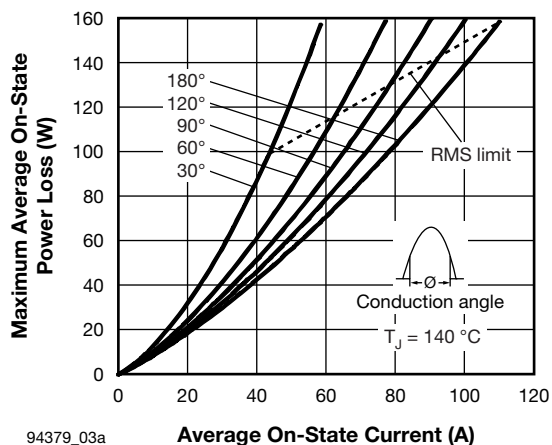

Fig. 3 - On-State Power Loss Characteristics

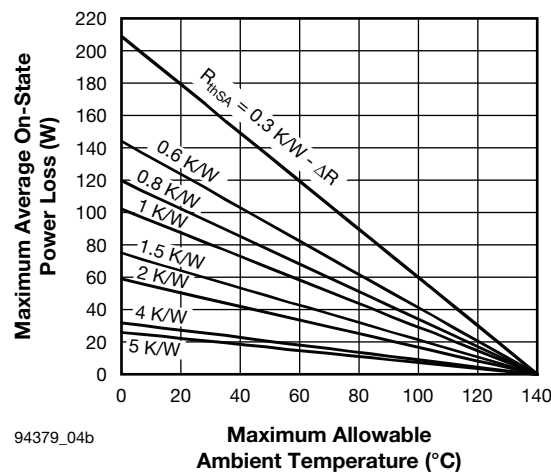
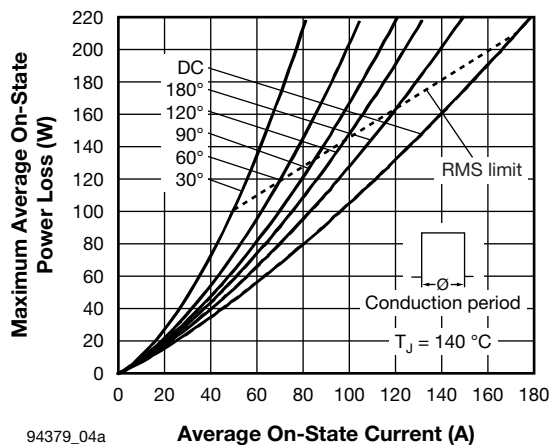

Fig. 4 - On-State Power Loss Characteristics



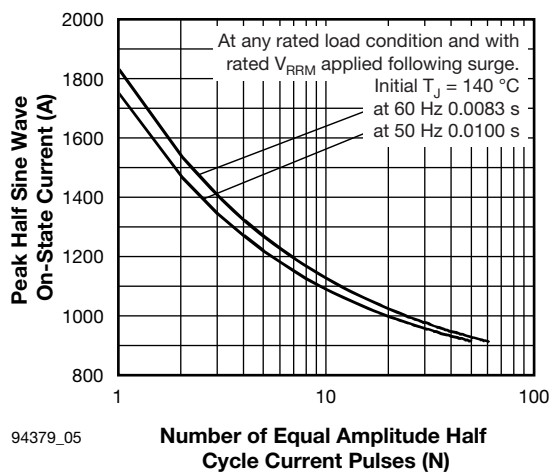

Fig. 5 - Maximum Non-Repetitive Surge Current

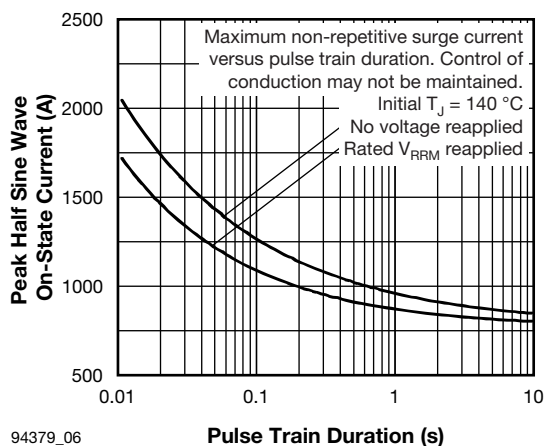

Fig. 6 - Maximum Non-Repetitive Surge Current

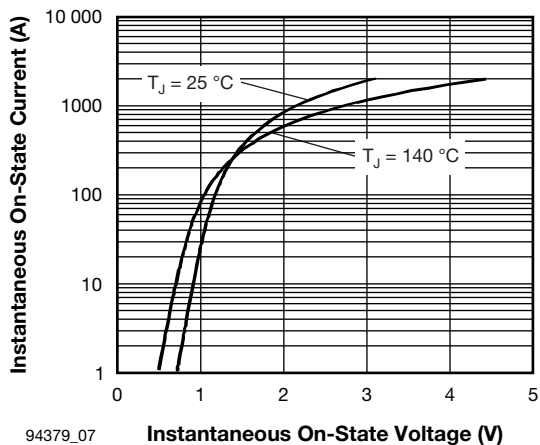

Fig. 7 - On-State Voltage Drop Characteristics

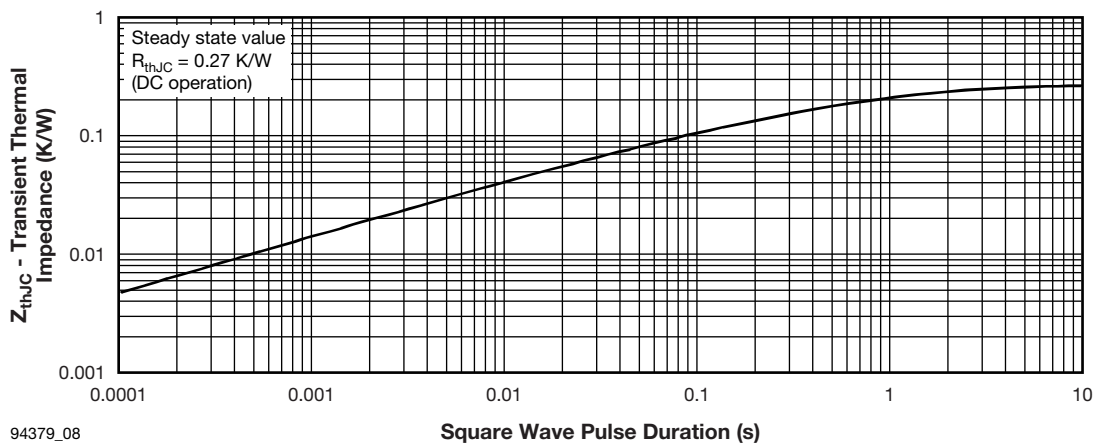

Fig. 8 - Thermal Impedance  $Z_{thJC}$  Characteristic



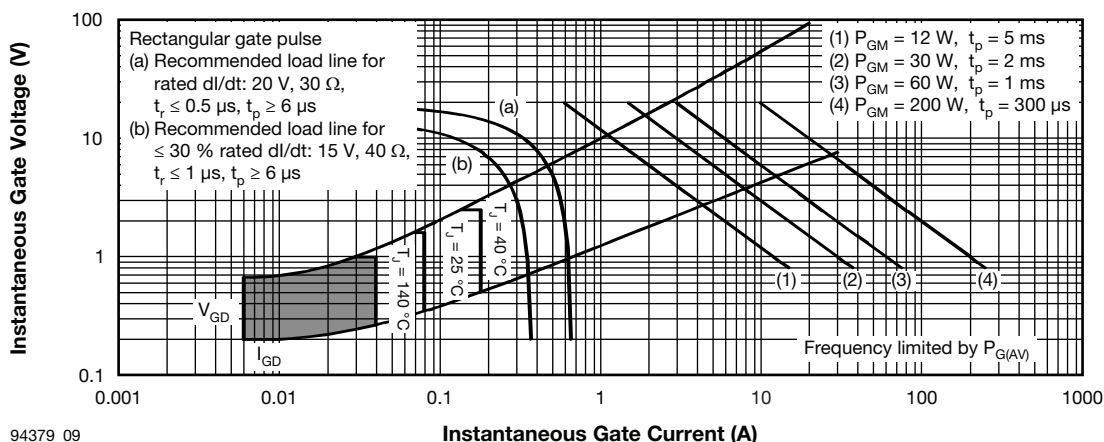

Fig. 9 - Gate Characteristics

## ORDERING INFORMATION TABLE

Device code	VS-	11	0	RKI	120	M	PbF
	1	2	3	4	5	6	7
1	Vishay Semiconductors product						
2	$I_{T(AV)}$ rated average output current (rounded/10)						
3	<ul style="list-style-type: none"> <li>0 = eyelet terminals (gate and auxiliary cathode leads)</li> <li>1 = fast-on terminals (gate and auxiliary cathode leads)</li> </ul>						
4	Thyristor						
5	Voltage code x 10 = $V_{RRM}$ (see Voltage Ratings table)						
6	<ul style="list-style-type: none"> <li>None = stud base 1/2"-20UNF-2A threads</li> <li>M = stud base metric threads M12 x 1.75 E 6</li> </ul>						
7	<ul style="list-style-type: none"> <li>None = standard production</li> <li>PbF = lead (Pb)-free</li> </ul>						

### LINKS TO RELATED DOCUMENTS

Dimensions

[www.vishay.com/doc?95003](http://www.vishay.com/doc?95003)



## TO-209AC (TO-94) for 110RKI and 111RKI Series

### DIMENSIONS in millimeters (inches)

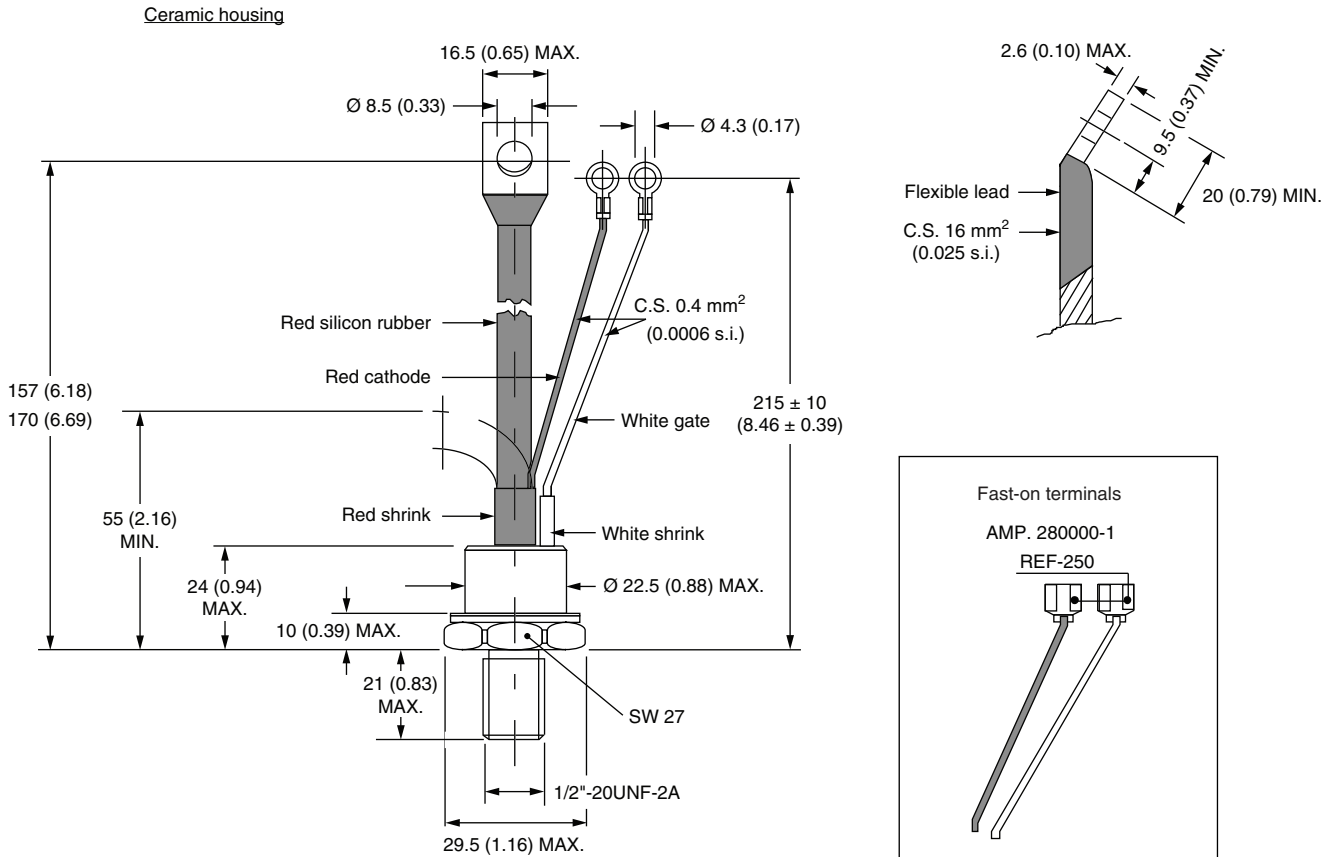

### Note

- For metric device: M12 x 1.75 contact factory





## Disclaimer

ALL PRODUCT, PRODUCT SPECIFICATIONS AND DATA ARE SUBJECT TO CHANGE WITHOUT NOTICE TO IMPROVE RELIABILITY, FUNCTION OR DESIGN OR OTHERWISE.

Vishay Intertechnology, Inc., its affiliates, agents, and employees, and all persons acting on its or their behalf (collectively, "Vishay"), disclaim any and all liability for any errors, inaccuracies or incompleteness contained in any datasheet or in any other disclosure relating to any product.

Vishay makes no warranty, representation or guarantee regarding the suitability of the products for any particular purpose or the continuing production of any product. To the maximum extent permitted by applicable law, Vishay disclaims (i) any and all liability arising out of the application or use of any product, (ii) any and all liability, including without limitation special, consequential or incidental damages, and (iii) any and all implied warranties, including warranties of fitness for particular purpose, non-infringement and merchantability.

Statements regarding the suitability of products for certain types of applications are based on Vishay's knowledge of typical requirements that are often placed on Vishay products in generic applications. Such statements are not binding statements about the suitability of products for a particular application. It is the customer's responsibility to validate that a particular product with the properties described in the product specification is suitable for use in a particular application. Parameters provided in datasheets and / or specifications may vary in different applications and performance may vary over time. All operating parameters, including typical parameters, must be validated for each customer application by the customer's technical experts. Product specifications do not expand or otherwise modify Vishay's terms and conditions of purchase, including but not limited to the warranty expressed therein.

Hyperlinks included in this datasheet may direct users to third-party websites. These links are provided as a convenience and for informational purposes only. Inclusion of these hyperlinks does not constitute an endorsement or an approval by Vishay of any of the products, services or opinions of the corporation, organization or individual associated with the third-party website. Vishay disclaims any and all liability and bears no responsibility for the accuracy, legality or content of the third-party website or for that of subsequent links.

Except as expressly indicated in writing, Vishay products are not designed for use in medical, life-saving, or life-sustaining applications or for any other application in which the failure of the Vishay product could result in personal injury or death. Customers using or selling Vishay products not expressly indicated for use in such applications do so at their own risk. Please contact authorized Vishay personnel to obtain written terms and conditions regarding products designed for such applications.

No license, express or implied, by estoppel or otherwise, to any intellectual property rights is granted by this document or by any conduct of Vishay. Product names and markings noted herein may be trademarks of their respective owners.