

MOSFET – N-Channel, POWERTRENCH®

100 V, 7.5 A, 22 mΩ

FDS3672

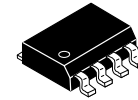

SOIC8
CASE 751EB

Features

- $r_{DS(ON)} = 19\text{ m}\Omega$ (Typ.), $V_{GS} = 10\text{ V}$, $I_D = 7.5\text{ A}$
- $Q_g(\text{tot}) = 28\text{ nC}$ (Typ.), $V_{GS} = 10\text{ V}$
- Low Miller Charge
- Low Q_{RR} Body Diode
- Optimized Efficiency at High Frequencies
- UIS Capability (Single Pulse and Repetitive Pulse)
- Pb-Free and Halide Free

Applications

- DC-DC Converters and Off-Line UPS
- Distributed Power Architecture and VRMs
- Primary Switch for 24 V and 48 V Systems
- High Voltage Synchronous Rectifier

MOSFET MAXIMUM RATINGS ($T_A = 25^\circ\text{C}$ unless otherwise noted.)

| Symbol | Parameter | Ratings | Unit |
|-------------------|---|-------------|----------------------|
| V_{DSS} | Drain to Source Voltage | 100 | V |
| V_{GS} | Gate to Source Voltage | ± 20 | V |
| I_D | Drain Current Continuous ($T_A = 25^\circ\text{C}$, $V_{GS} = 10\text{ V}$, $R_{\theta JA} = 50^\circ\text{C/W}$) | 7.5 | A |
| | Continuous ($T_A = 100^\circ\text{C}$, $V_{GS} = 10\text{ V}$, $R_{\theta JA} = 50^\circ\text{C/W}$) | 4.8 | |
| | Pulsed | Figure 4 | |
| E_{AS} | Single Pulse Avalanche Energy (Note 1) | 416 | mJ |
| P_D | Power Dissipation | 2.5 | W |
| | Derate above 25°C | 20 | mW/ $^\circ\text{C}$ |
| T_J , T_{STG} | Operating and Storage Junction Temperature Range | -55 to +150 | $^\circ\text{C}$ |

Stresses exceeding those listed in the Maximum Ratings table may damage the device. If any of these limits are exceeded, device functionality should not be assumed, damage may occur and reliability may be affected.

- Starting $T_J = 25^\circ\text{C}$, $L = 13\text{ mH}$, $I_{AS} = 8\text{ A}$.

THERMAL CHARACTERISTICS

| Symbol | Parameter | Value | Unit |
|-----------------|--|-------|--------------------|
| $R_{\theta JA}$ | Thermal Resistance, Junction to Ambient at 10 s (Note 3) | 50 | $^\circ\text{C/W}$ |
| $R_{\theta JA}$ | Thermal Resistance, Junction to Ambient at 1000 s (Note 3) | 85 | $^\circ\text{C/W}$ |
| $R_{\theta JC}$ | Thermal Resistance, Junction to Case (Note 2) | 25 | $^\circ\text{C/W}$ |

- $R_{\theta JA}$ is the sum of the junction-to-case and case-to-ambient thermal resistance where the case thermal reference is defined as the solder mounting surface of the drain pins. $R_{\theta JC}$ is guaranteed by design while $R_{\theta CA}$ is determined by the user's board design.
- $R_{\theta JA}$ is measured with 1.0 in² copper on FR-4 board.

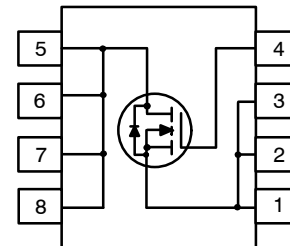

MARKING DIAGRAM

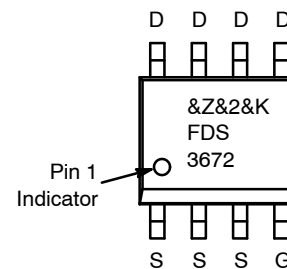

- &Z = Assembly Plant Code
- &2 = Date Code (Year & Week)
- &K = Lot Traceability Code
- FDS3672 = Specific Device Code

ORDERING INFORMATION

| Device | Package | Shipping |
|---------|--------------------|------------------------|
| FDS3672 | SOIC8 (Pb-Free) | 2,500 / Tape & Reel |

†For information on tape and reel specifications, including part orientation and tape sizes, please refer to our Tape and Reel Packaging Specification Brochure, BRD8011/D.

FDS3672

ELECTRICAL CHARACTERISTICS (T_A = 25°C unless otherwise noted.)

| Symbol | Parameter | Test Conditions | Min | Typ | Max | Unit |
|--------|-----------|-----------------|-----|-----|-----|------|
|--------|-----------|-----------------|-----|-----|-----|------|

OFF CHARACTERISTICS

| | | | | | | |
|-------------------|-----------------------------------|---|-----|---|------|----|
| B _{VDSS} | Drain to Source Breakdown Voltage | I _D = 250 μA, V _{GS} = 0 V | 100 | - | - | V |
| I _{DSS} | Zero Gate Voltage Drain Current | V _{DS} = 80 V, V _{GS} = 0 V | - | - | 1 | μA |
| | | V _{DS} = 80 V, V _{GS} = 0 V, T _C = 150°C | - | - | 250 | |
| I _{GSS} | Gate to Source Leakage Current | V _{GS} = ±20 V | - | - | ±100 | nA |

ON CHARACTERISTICS

| | | | | | | |
|---------------------|----------------------------------|--|---|-------|-------|---|
| V _{GS(TH)} | Gate to Source Threshold Voltage | V _{GS} = V _{DS} , I _D = 250 μA | 2 | - | 4 | V |
| r _{DS(ON)} | Drain to Source On Resistance | I _D = 7.5 A, V _{GS} = 10 V | - | 0.019 | 0.023 | Ω |
| | | I _D = 6.8 A, V _{GS} = 6 V, | - | 0.023 | 0.028 | |
| | | I _D = 7.5 A, V _{GS} = 10 V, T _C = 150°C | - | 0.035 | 0.043 | |

DYNAMIC CHARACTERISTICS

| | | | | | | |
|---------------------|----------------------------------|--|---|------|----|----|
| C _{ISS} | Input Capacitance | V _{DS} = 25 V, V _{GS} = 0 V, f = 1 MHz | - | 2015 | - | pF |
| C _{OSS} | Output Capacitance | | - | 285 | - | pF |
| C _{RSS} | Reverse Transfer Capacitance | | - | 70 | - | pF |
| Q _{g(TOT)} | Total Gate Charge at 10 V | V _{GS} = 0 V to 10 V, V _{DD} = 50 V, I _D = 7.5 A, I _g = 1.0 A | - | 28 | 37 | nC |
| Q _{g(TH)} | Threshold Gate Charge | V _{GS} = 0 V to 2 V, V _{DD} = 50 V, I _D = 7.5 A, I _g = 1.0 A | - | 4 | 6 | nC |
| Q _{gs} | Gate to Source Gate Charge | V _{DD} = 50 V, I _D = 7.5 A, I _g = 1.0 A | - | 10 | - | nC |
| Q _{gs2} | Gate Charge Threshold to Plateau | | - | 6.8 | - | nC |
| Q _{gd} | Gate to Drain "Miller" Charge | | - | 6 | - | nC |

SWITCHING CHARACTERISTICS (V_{GS} = 10 V)

| | | | | | | |
|---------------------|---------------------|---|---|----|----|----|
| t _{ON} | Turn-On Time | V _{DD} = 50 V, I _D = 4 A, V _{GS} = 10 V, R _{GS} = 10 Ω | - | - | 51 | ns |
| t _{d(ON)} | Turn-On Delay Time | | - | 14 | - | ns |
| t _r | Rise Time | | - | 20 | - | ns |
| t _{d(OFF)} | Turn-Off Delay Time | | - | 37 | - | ns |
| t _f | Fall Time | | - | 27 | - | ns |
| t _{OFF} | Turn-Off Time | | - | - | 96 | ns |

DRAIN-SOURCE DIODE CHARACTERISTICS

| | | | | | | |
|-----------------|-------------------------------|--|---|---|------|----|
| V _{SD} | Drain to Source Diode Voltage | I _{SD} = 7.5 A | - | - | 1.25 | V |
| | | I _{SD} = 4 A | - | - | 1.0 | V |
| t _{rr} | Reverse Recovery Time | I _{SD} = 7.5 A, dI _{SD} /dt = 100 A/μs | - | - | 55 | ns |
| Q _{RR} | Reverse Recovered Charge | I _{SD} = 7.5 A, dI _{SD} /dt = 100 A/μs | - | - | 90 | nC |

Product parametric performance is indicated in the Electrical Characteristics for the listed test conditions, unless otherwise noted. Product performance may not be indicated by the Electrical Characteristics if operated under different conditions.

TYPICAL CHARACTERISTICS

($T_A = 25^\circ\text{C}$ unless otherwise noted)

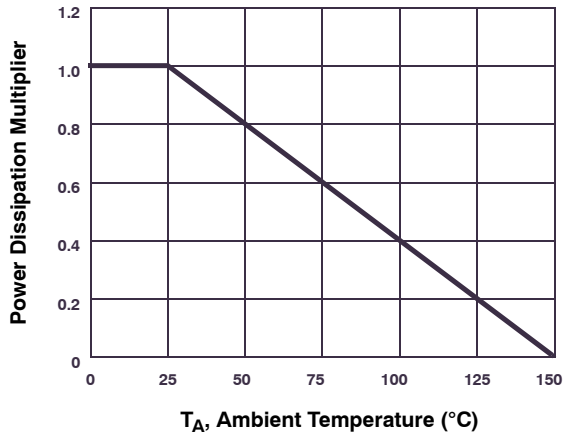

Figure 1. Normalized Power Dissipation vs. Ambient Temperature

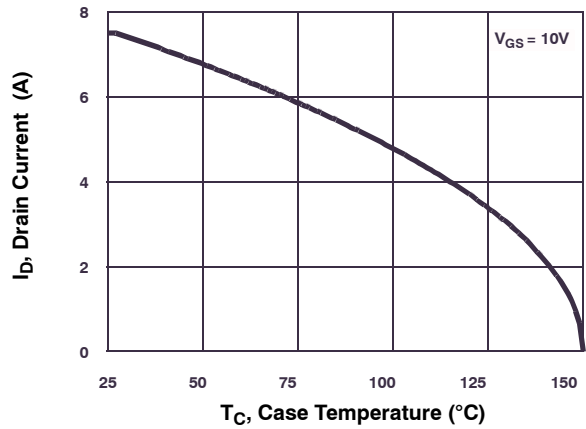

Figure 2. Maximum Continuous Drain Current vs. Case Temperature

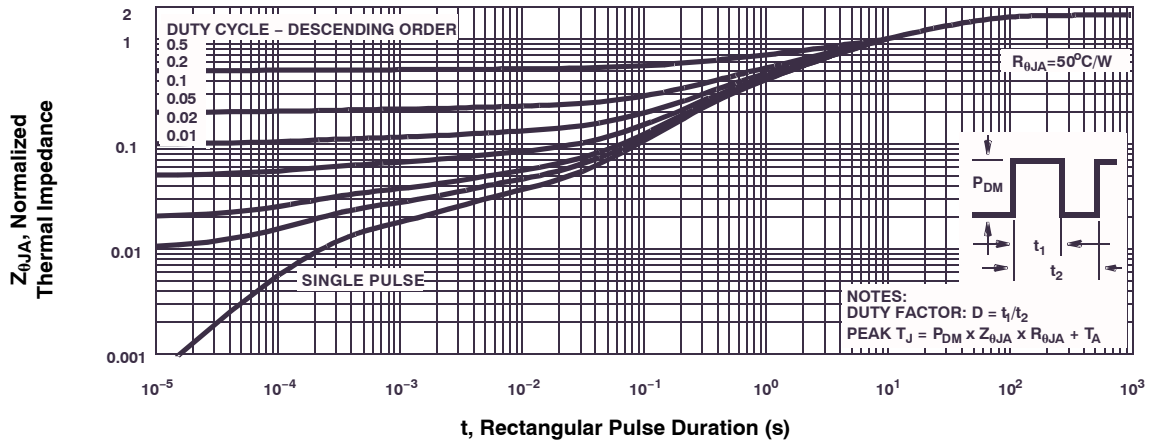

Figure 3. Normalized Maximum Transient Thermal Impedance

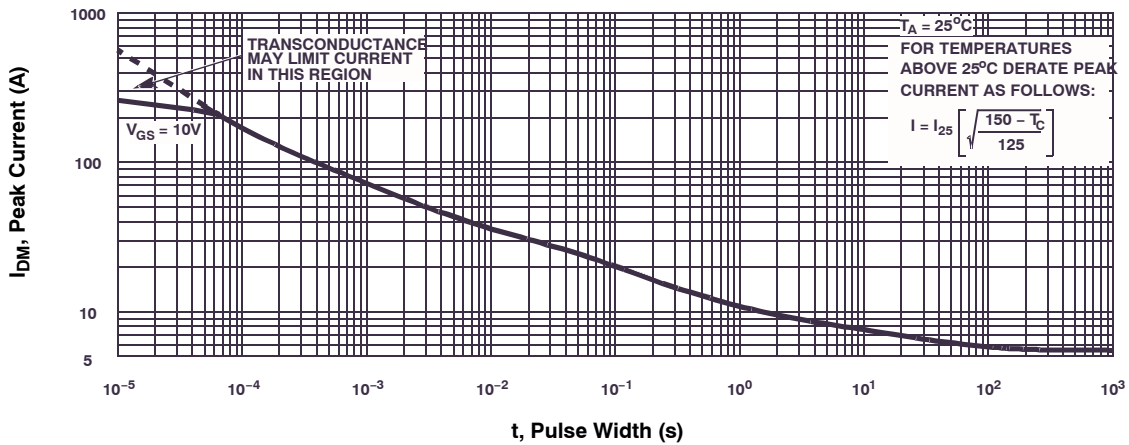

Figure 4. Peak Current Capability

TYPICAL CHARACTERISTICS (Continued)

($T_A = 25^\circ\text{C}$ unless otherwise noted)

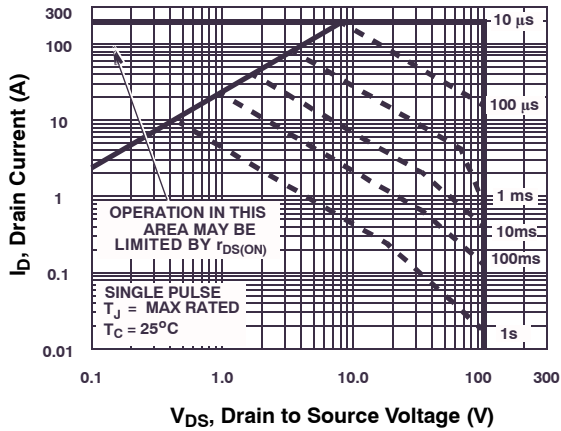

Figure 5. Forward Bias Safe Operating Area

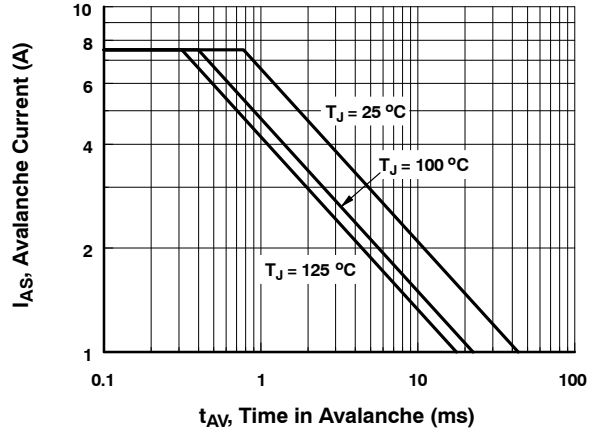

Figure 6. Unclamped Inductive Switching Capability

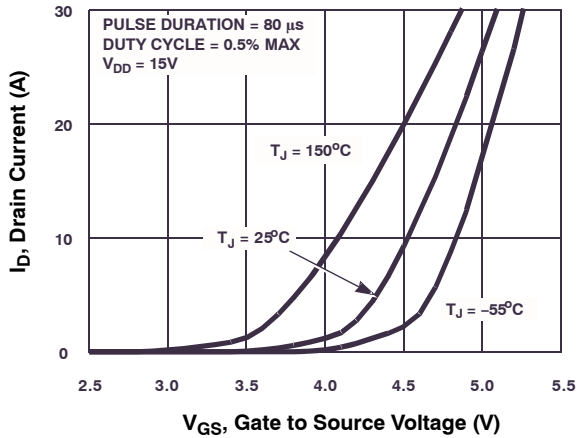

Figure 7. Transfer Characteristics

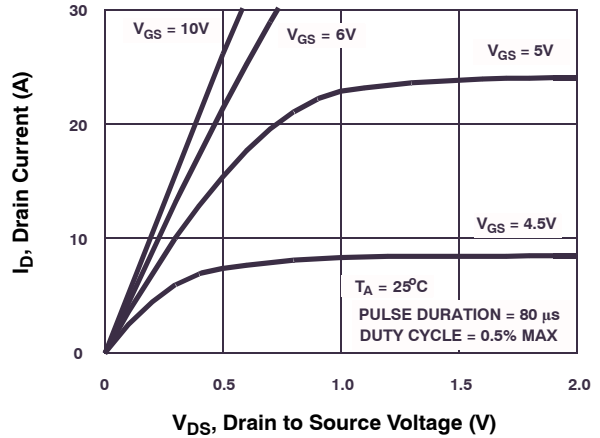

Figure 8. Saturation Characteristics

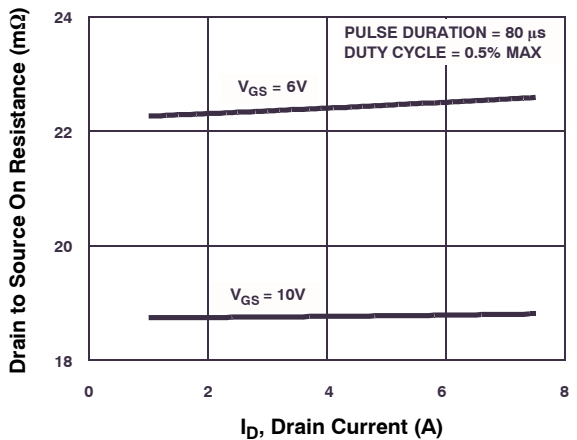

Figure 9. Drain to Source On Resistance vs. Drain Current

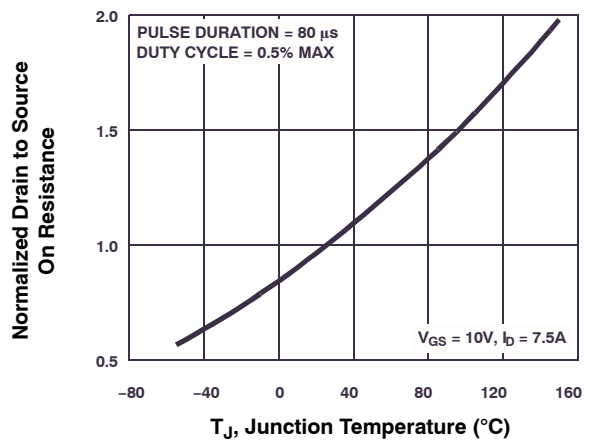

Figure 10. Normalized Drain to Source On Resistance vs. Junction Temperature

TYPICAL CHARACTERISTICS (Continued)

($T_A = 25^\circ\text{C}$ unless otherwise noted)

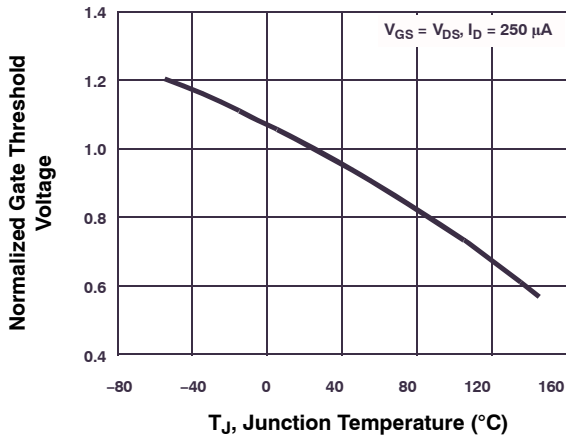

Figure 11. Normalized Gate Threshold Voltage vs. Junction Temperature

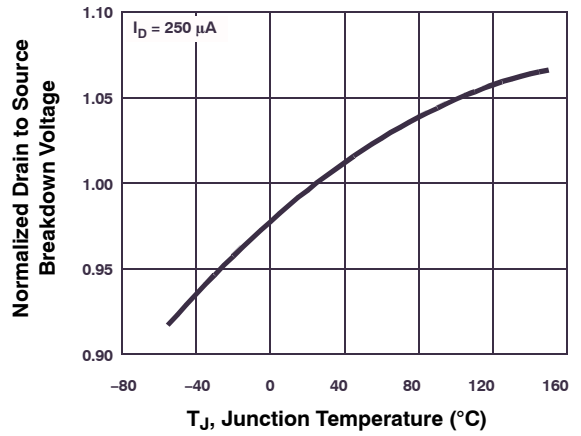

Figure 12. Normalized Drain to Source Breakdown Voltage vs. Junction Temperature

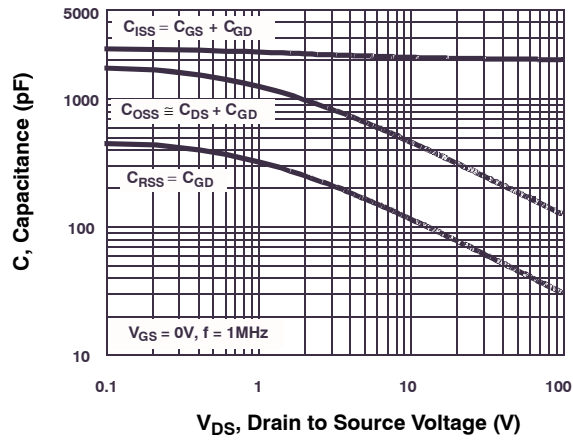

Figure 13. Capacitance vs. Drain to Source Voltage

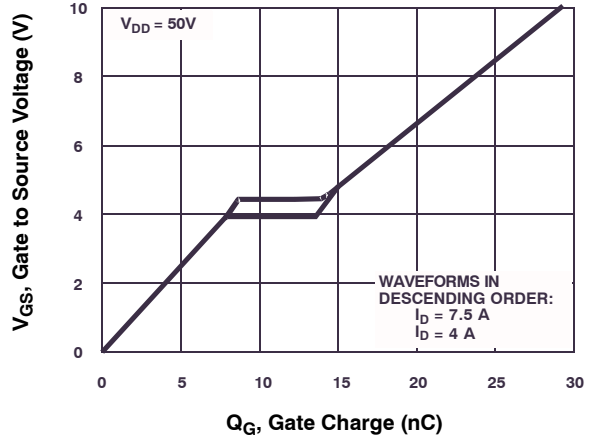

Figure 14. Gate Charge Waveforms for Constant Gate Currents

TEST CIRCUITS AND WAVEFORMS

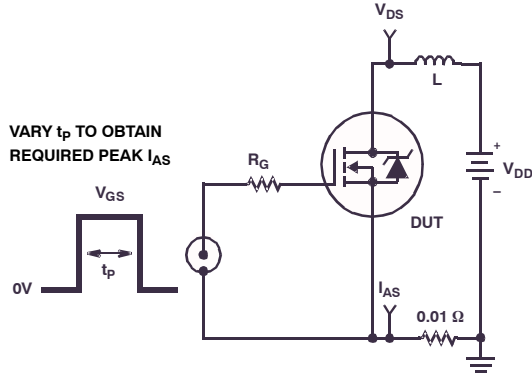

Figure 15. Unclamped Energy Test Circuit

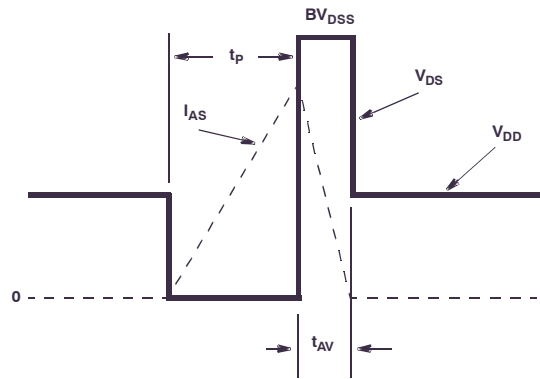

Figure 16. Unclamped Energy Waveforms

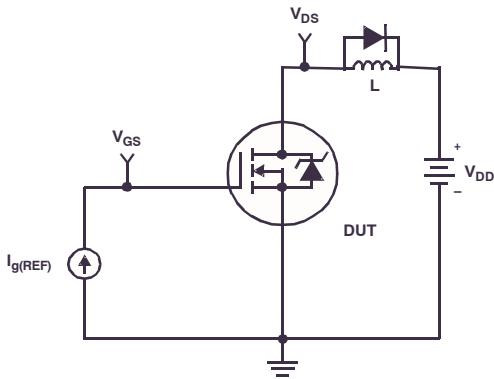

Figure 17. Gate Charge Test Circuit

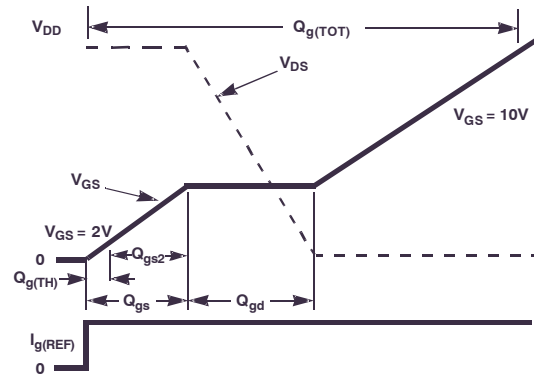

Figure 18. Gate Charge Waveforms

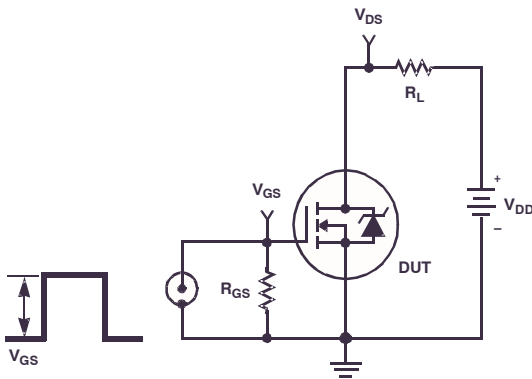

Figure 19. Switching Time Test Circuit

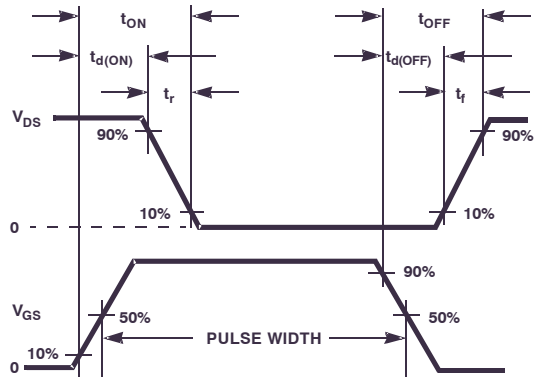

Figure 20. Switching Time Waveforms

POWERTRENCH is a registered trademark of Semiconductor Components Industries, LLC dba "onsemi" or its affiliates and/or subsidiaries in the United States and/or other countries.

MECHANICAL CASE OUTLINE
PACKAGE DIMENSIONS

SOIC8
CASE 751EB
ISSUE A

DATE 24 AUG 2017

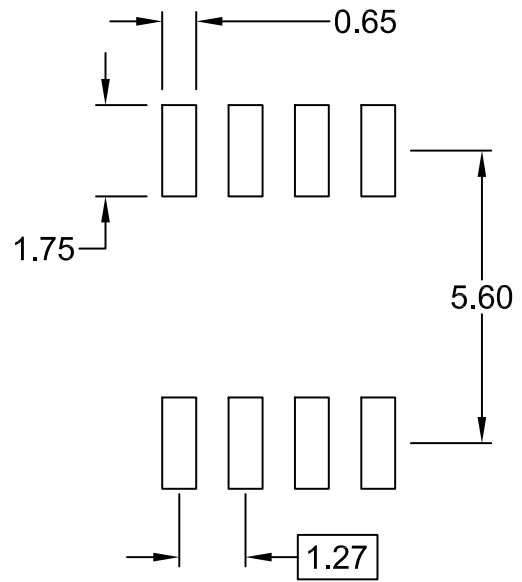
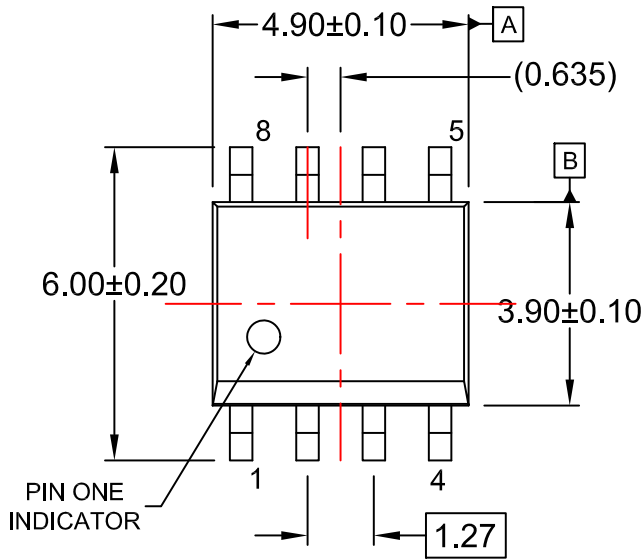

⊕ 0.25 (M) C B A

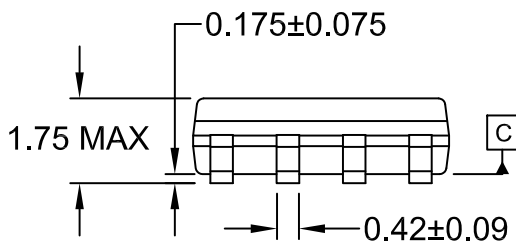

⌒ 0.10

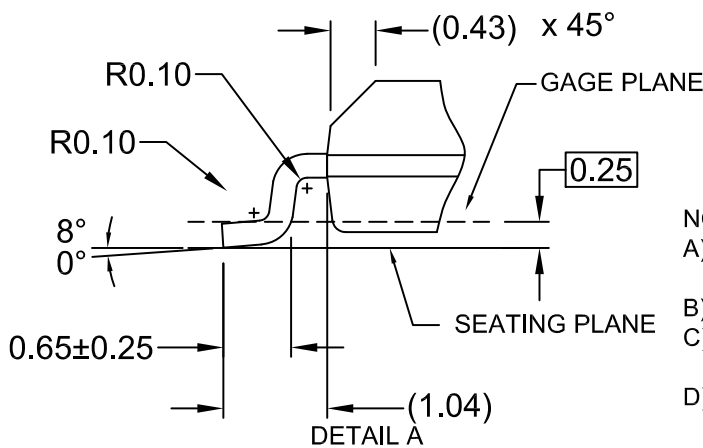
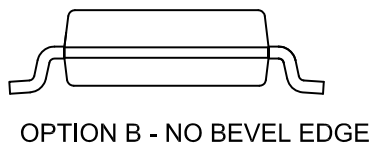
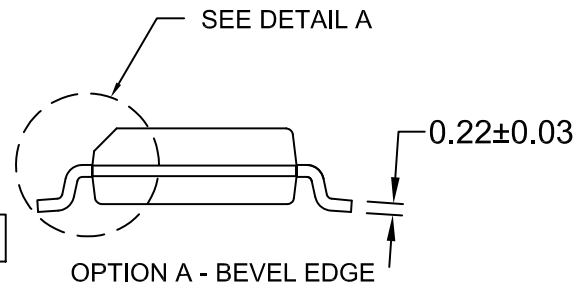

DETAIL A
 SCALE: 2:1

NOTES:

- A) THIS PACKAGE CONFORMS TO JEDEC MS-012, VARIATION AA.
- B) ALL DIMENSIONS ARE IN MILLIMETERS.
- C) DIMENSIONS DO NOT INCLUDE MOLD FLASH OR BURRS.
- D) LANDPATTERN STANDARD: SOIC127P600X175-8M

| | | |
|-------------------------|--------------------|--|
| DOCUMENT NUMBER: | 98AON13735G | Electronic versions are uncontrolled except when accessed directly from the Document Repository. Printed versions are uncontrolled except when stamped "CONTROLLED COPY" in red. |
| DESCRIPTION: | SOIC8 | PAGE 1 OF 1 |

ON Semiconductor and **ON** are trademarks of Semiconductor Components Industries, LLC dba ON Semiconductor or its subsidiaries in the United States and/or other countries. ON Semiconductor reserves the right to make changes without further notice to any products herein. ON Semiconductor makes no warranty, representation or guarantee regarding the suitability of its products for any particular purpose, nor does ON Semiconductor assume any liability arising out of the application or use of any product or circuit, and specifically disclaims any and all liability, including without limitation special, consequential or incidental damages. ON Semiconductor does not convey any license under its patent rights nor the rights of others.

onsemi, **Onsemi**, and other names, marks, and brands are registered and/or common law trademarks of Semiconductor Components Industries, LLC dba "**onsemi**" or its affiliates and/or subsidiaries in the United States and/or other countries. **onsemi** owns the rights to a number of patents, trademarks, copyrights, trade secrets, and other intellectual property. A listing of **onsemi**'s product/patent coverage may be accessed at www.onsemi.com/site/pdf/Patent-Marking.pdf. **onsemi** reserves the right to make changes at any time to any products or information herein, without notice. The information herein is provided "as-is" and **onsemi** makes no warranty, representation or guarantee regarding the accuracy of the information, product features, availability, functionality, or suitability of its products for any particular purpose, nor does **onsemi** assume any liability arising out of the application or use of any product or circuit, and specifically disclaims any and all liability, including without limitation special, consequential or incidental damages. Buyer is responsible for its products and applications using **onsemi** products, including compliance with all laws, regulations and safety requirements or standards, regardless of any support or applications information provided by **onsemi**. "Typical" parameters which may be provided in **onsemi** data sheets and/or specifications can and do vary in different applications and actual performance may vary over time. All operating parameters, including "Typicals" must be validated for each customer application by customer's technical experts. **onsemi** does not convey any license under any of its intellectual property rights nor the rights of others. **onsemi** products are not designed, intended, or authorized for use as a critical component in life support systems or any FDA Class 3 medical devices or medical devices with a same or similar classification in a foreign jurisdiction or any devices intended for implantation in the human body. Should Buyer purchase or use **onsemi** products for any such unintended or unauthorized application, Buyer shall indemnify and hold **onsemi** and its officers, employees, subsidiaries, affiliates, and distributors harmless against all claims, costs, damages, and expenses, and reasonable attorney fees arising out of, directly or indirectly, any claim of personal injury or death associated with such unintended or unauthorized use, even if such claim alleges that **onsemi** was negligent regarding the design or manufacture of the part. **onsemi** is an Equal Opportunity/Affirmative Action Employer. This literature is subject to all applicable copyright laws and is not for resale in any manner.

ADDITIONAL INFORMATION

TECHNICAL PUBLICATIONS:

Technical Library: www.onsemi.com/design/resources/technical-documentation
onsemi Website: www.onsemi.com

ONLINE SUPPORT: www.onsemi.com/support

For additional information, please contact your local Sales Representative at www.onsemi.com/support/sales

