

# MOSFET – Power, N-Channel, SMPS

**500 V, 44 A, 120 mΩ**

## FDH44N50

### Description

UniFET™ MOSFET is onsemi's high voltage MOSFET family based on planar stripe and DMOS technology. This MOSFET is tailored to reduce on-state resistance, and to provide better switching performance and higher avalanche energy strength. This device family is suitable for switching power converter applications such as power factor correction (PFC), flat panel display (FPD) TV power, ATX and electronic lamp ballasts.

### Features

- Low Gate Charge  $Q_g$  Results in Simple Drive Requirement (Typ. 90 nC)
- Improved Gate, Avalanche and High Reapplied dv/dt Ruggedness
- Reduced  $R_{DS(on)}$  (110 mΩ (Typ.) @  $V_{GS} = 10\text{ V}$ ,  $I_D = 22\text{ A}$ )
- Reduced Miller Capacitance and Low Input Capacitance (Typ.  $C_{RSS} = 40\text{ pF}$ )
- Improved Switching Speed with Low EMI
- 175°C Rated Junction Temperature
- This Device is Pb-Free and is RoHS Compliant

### Applications

- Lighting
- Uninterruptible Power Supply
- AC-DC Power Supply

$V_{DS}$	$R_{DS(on)}$ MAX	$I_D$ MAX
500 V	120 mΩ @ 10 V	44 A

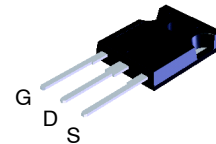
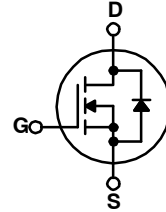

TO-247-3LD  
CASE 340CK

### MARKING DIAGRAM

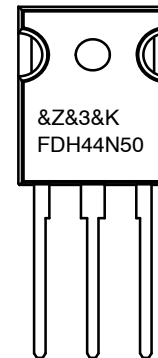

- &Z = Assembly Plant Code
- &3 = 3-Digit Date Code (YWW)
- &K = 2-Digit Lot Traceability Code
- FDH44N50 = Specific Device Code

### ORDERING INFORMATION

See detailed ordering and shipping information on page 2 of this data sheet.

# FDH44N50

## ABSOLUTE MAXIMUM RATINGS (T<sub>C</sub> = 25°C unless otherwise noted)

Symbol	Parameter	FDH44N50	Unit
V <sub>DSS</sub>	Drain to Source Voltage	500	V
V <sub>GS</sub>	Gate-Source Voltage	±30	V
I <sub>D</sub>	Drain Current – – Continuous (T <sub>C</sub> = 25°C, V <sub>GS</sub> = 10 V) – Continuous (T <sub>C</sub> = 100°C, V <sub>GS</sub> = 10 V) – Pulsed (Note 1)	44 32 176	A
P <sub>D</sub>	Power Dissipation	750	W
	Derate Above 25°C	5	W/°C
T <sub>J</sub> , T <sub>STG</sub>	Operating and Storage Temperature	–55 to + 175	°C
	Soldering Temperature for 10 Seconds	300 (1.6 mm from Case)	°C
	Mounting Torque, 8–32 or M3 Screw	10 ibf*in (1.1 N*m)	

Stresses exceeding those listed in the Maximum Ratings table may damage the device. If any of these limits are exceeded, device functionality should not be assumed, damage may occur and reliability may be affected.

1. Repetitive Rating: Pulse width limited by maximum junction temperature.

## PACKAGE MARKING AND ORDERING INFORMATION

Part Number	Top Mark	Package	Package Method	Reel Size	Tape Width	Quantity
FDH44N50	FDH44N50	TO-247-3	Tube	N/A	N/A	30 Units

## THERMAL CHARACTERISTICS

Symbol	Parameter	FDH44N50	Unit
R <sub>θJC</sub>	Thermal Resistance, Junction to Case, Max.	0.2	°C/W
R <sub>θJA</sub>	Thermal Resistance, Junction to Ambient, Max.	40	

# FDH44N50

## ELECTRICAL CHARACTERISTICS (T<sub>C</sub> = 25°C unless otherwise noted)

Symbol	Parameter	Test Condition	Min.	Typ.	Max.	Unit	
<b>STATICS</b>							
BV <sub>DSS</sub>	Drain to Source Breakdown Voltage	I <sub>D</sub> = 250 μA, V <sub>GS</sub> = 0 V	500	–	–	V	
ΔBV <sub>DSS</sub> / ΔT <sub>J</sub>	Breakdown Voltage Temperature Coefficient	I <sub>D</sub> = 1 mA, Referenced to 25°C	–	0.61	–	V/°C	
r <sub>DS(ON)</sub>	Drain to Source On-Resistance	V <sub>GS</sub> = 10 V, I <sub>D</sub> = 22 A	–	0.11	0.12	Ω	
V <sub>GS(th)</sub>	Gate Threshold Voltage	V <sub>DS</sub> = V <sub>GS</sub> , I <sub>D</sub> = 250 μA	2	3.15	4	V	
I <sub>DSS</sub>	Zero Gate Voltage Drain Current	V <sub>DS</sub> = 500 V V <sub>GS</sub> = 0 V	T <sub>C</sub> = 25°C	–	–	25	μA
			T <sub>C</sub> = 150°C	–	–	250	μA
I <sub>GSS</sub>	Gate to Source Leakage Current	V <sub>GS</sub> = ±20 V	–	–	±100	nA	

## DYNAMICS

g <sub>fS</sub>	Forward Transconductance	V <sub>DS</sub> = 50 V, I <sub>D</sub> = 22 A	11	–	–	S
Q <sub>g(TOT)</sub>	Total Gate Charge at 10 V	V <sub>GS</sub> = 10 V, V <sub>DS</sub> = 400 V, I <sub>D</sub> = 44 A	–	90	108	nC
Q <sub>gs</sub>	Gate to Source Gate Charge		–	24	29	nC
Q <sub>gd</sub>	Gate to Drain "Miller" Charge		–	31	37	nC
t <sub>d(on)</sub>	Turn-On Delay Time	V <sub>DD</sub> = 250 V, I <sub>D</sub> = 44 A, R <sub>D</sub> = 5.68 Ω, R <sub>G</sub> = 2.15 Ω	–	16	–	ns
t <sub>r</sub>	Turn-On Rise Time		–	84	–	ns
t <sub>d(off)</sub>	Turn-Off Delay Time		–	45	–	ns
t <sub>f</sub>	Turn-Off Fall Time		–	79	–	ns
C <sub>iss</sub>	Input Capacitance	V <sub>DS</sub> = 25 V, V <sub>GS</sub> = 0 V, f = 1 MHz	–	5335	–	pF
C <sub>oss</sub>	Output Capacitance		–	645	–	pF
C <sub>rss</sub>	Reverse Transfer Capacitance		–	40	–	pF

## AVALANCHE CHARACTERISTICS

E <sub>AS</sub>	Single Pulse Avalanche Energy (Note 2)		1500	–	–	mJ
I <sub>AR</sub>	Avalanche Current		–	–	44	A

## DRAIN-SOURCE DIODE CHARACTERISTICS

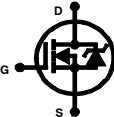
I <sub>S</sub>	Continuous Source Current (Body Diode)	MOSFET symbol Showing the integral reverse p-n junction diode.		–	–	44	A
I <sub>SM</sub>	Pulsed Source Current (Body Diode) (Note 1)			–	–	176	A
V <sub>SD</sub>	Source to Drain Diode Voltage	I <sub>SD</sub> = 44 A	–	0.900	1.2	V	
t <sub>rr</sub>	Reverse Recovery Time	I <sub>SD</sub> = 44 A, dI <sub>SD</sub> /dt = 100 A/μs	–	920	1100	ns	
Q <sub>rr</sub>	Reverse Recovery Charge	I <sub>SD</sub> = 44 A, dI <sub>SD</sub> /dt = 100 A/μs	–	14	18	μC	

Product parametric performance is indicated in the Electrical Characteristics for the listed test conditions, unless otherwise noted. Product performance may not be indicated by the Electrical Characteristics if operated under different conditions.

2. Starting T<sub>J</sub> = 25°C, L = 1.61 mH, I<sub>AS</sub> = 44 A

# FDH44N50

## TYPICAL CHARACTERISTICS

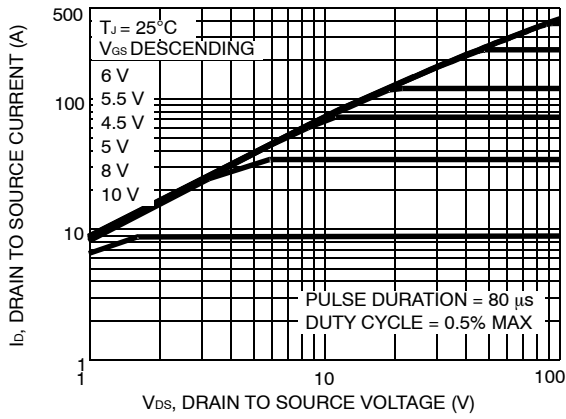

Figure 1. Output Characteristics

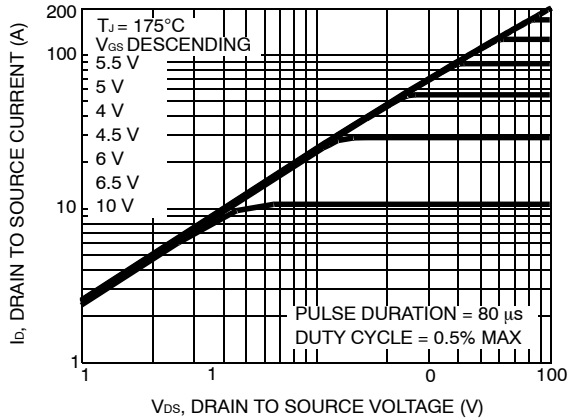

Figure 2. Output Characteristics

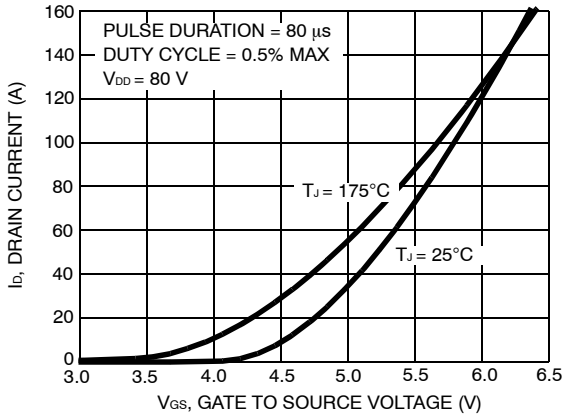

Figure 3. Transfer Characteristics

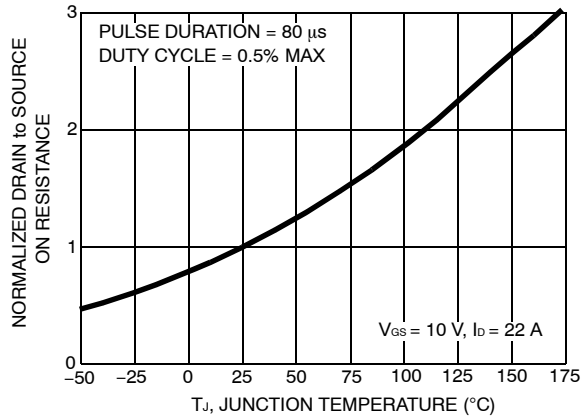

Figure 4. Normalized Drain to Source On Resistance vs. Junction Temperature

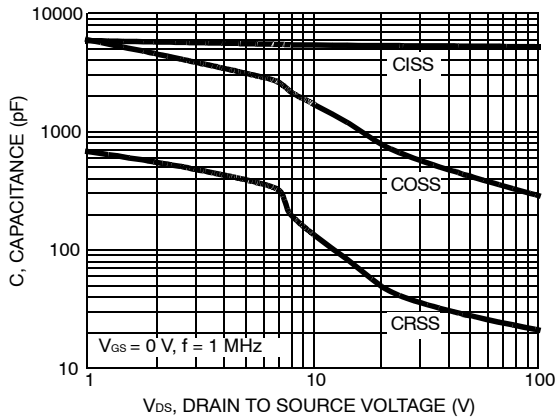

Figure 5. Capacitance vs. Drain to Source Voltage

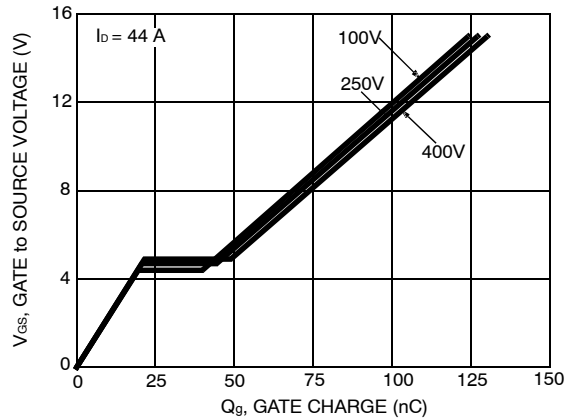
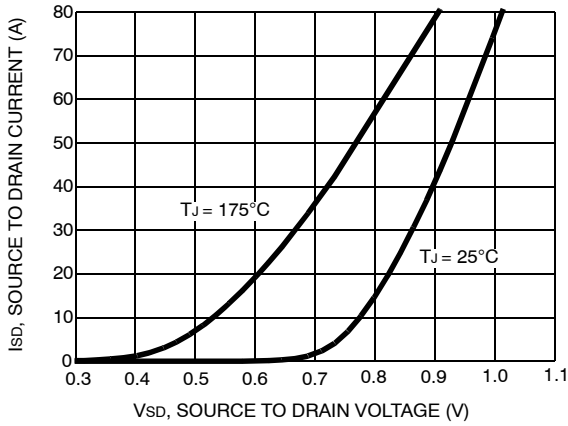

Figure 6. Gate Charge Waveforms for Constant Gate Current

# FDH44N50

## TYPICAL CHARACTERISTICS



**Figure 7. Body Diode Forward Voltage vs. Body Diode Current**

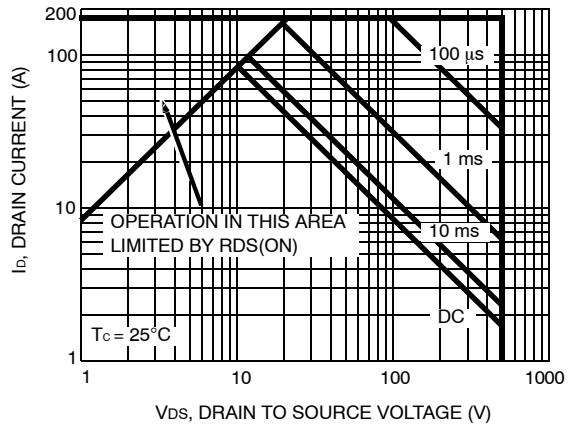

**Figure 8. Maximum Safe Operating Area**

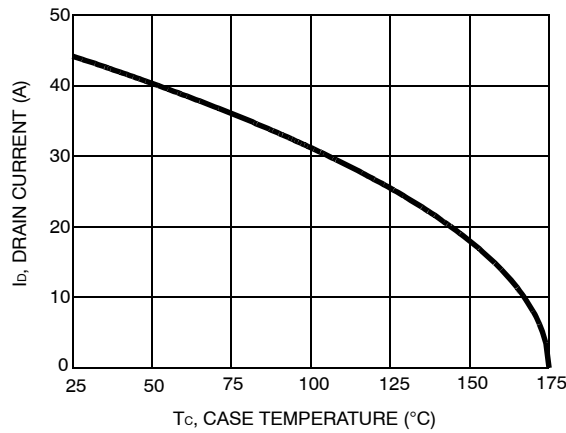

**Figure 9. Maximum Drain Current vs. Case Temperature**

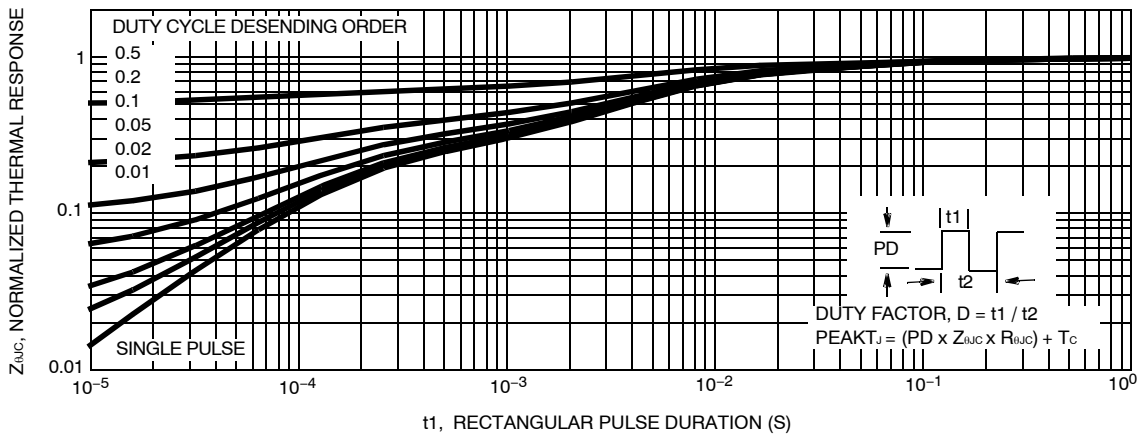

**Figure 10. Normalized Transient Thermal Impedance, Junction to Case**

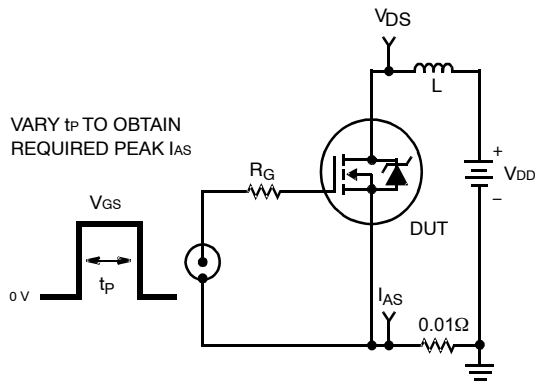

Figure 11. Unclamped Energy Test Circuit

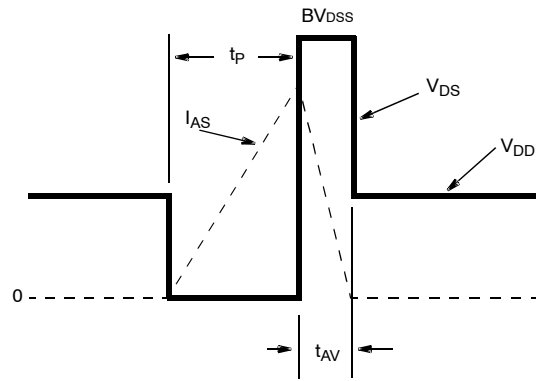

Figure 12. Unclamped Energy Waveforms

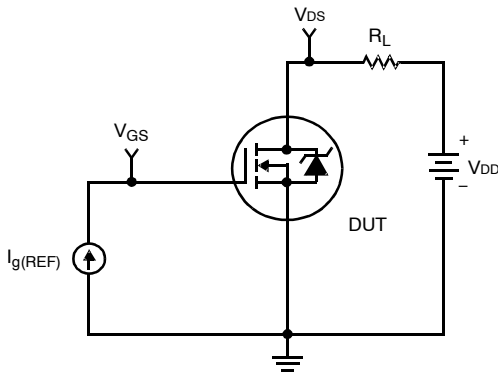

Figure 13. Gate Charge Test Circuit

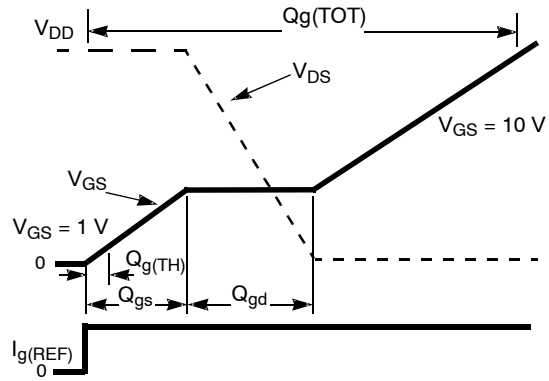

Figure 14. Gate Charge Waveforms

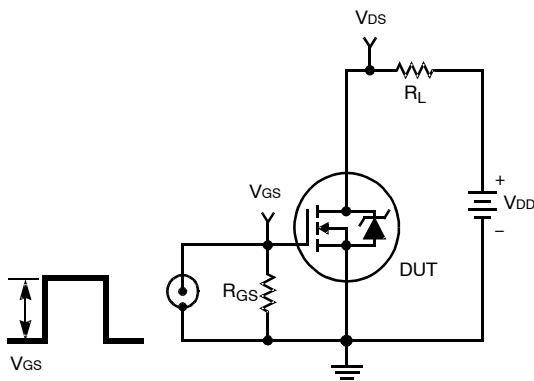

Figure 15. Switching Time Test Circuit

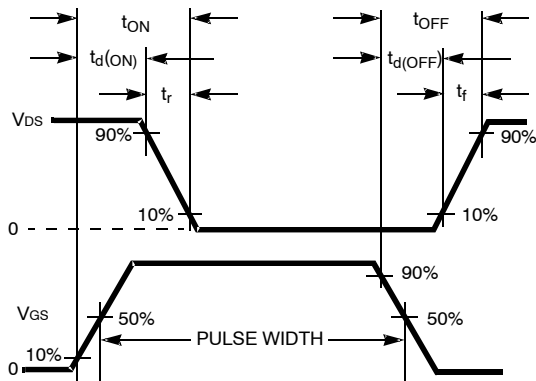

Figure 16. Switching Time Waveform

UniFET is a trademark of Semiconductor Components Industries, LLC dba "onsemi" or its affiliates and/or subsidiaries in the United States and/or other countries.

**TO-247-3LD SHORT LEAD**  
**CASE 340CK**  
**ISSUE A**

DATE 31 JAN 2019



NOTES: UNLESS OTHERWISE SPECIFIED.

- A. DIMENSIONS ARE EXCLUSIVE OF BURRS, MOLD FLASH, AND TIE BAR EXTRUSIONS.
- B. ALL DIMENSIONS ARE IN MILLIMETERS.
- C. DRAWING CONFORMS TO ASME Y14.5 - 2009.
- D. DIMENSION A1 TO BE MEASURED IN THE REGION DEFINED BY L1.
- E. LEAD FINISH IS UNCONTROLLED IN THE REGION DEFINED BY L1.

**GENERIC MARKING DIAGRAM\***

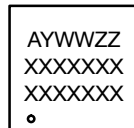

- XXXX = Specific Device Code
- A = Assembly Location
- Y = Year
- WW = Work Week
- ZZ = Assembly Lot Code

\*This information is generic. Please refer to device data sheet for actual part marking. Pb-Free indicator, "G" or microdot "•", may or may not be present. Some products may not follow the Generic Marking.

DIM	MILLIMETERS		
	MIN	NOM	MAX
A	4.58	4.70	4.82
A1	2.20	2.40	2.60
A2	1.40	1.50	1.60
b	1.17	1.26	1.35
b2	1.53	1.65	1.77
b4	2.42	2.54	2.66
c	0.51	0.61	0.71
D	20.32	20.57	20.82
D1	13.08	~	~
D2	0.51	0.93	1.35
E	15.37	15.62	15.87
E1	12.81	~	~
E2	4.96	5.08	5.20
e	~	5.56	~
L	15.75	16.00	16.25
L1	3.69	3.81	3.93
ØP	3.51	3.58	3.65
ØP1	6.60	6.80	7.00
Q	5.34	5.46	5.58
S	5.34	5.46	5.58

<b>DOCUMENT NUMBER:</b>	<b>98AON13851G</b>	Electronic versions are uncontrolled except when accessed directly from the Document Repository. Printed versions are uncontrolled except when stamped "CONTROLLED COPY" in red.
<b>DESCRIPTION:</b>	<b>TO-247-3LD SHORT LEAD</b>	<b>PAGE 1 OF 1</b>

ON Semiconductor and are trademarks of Semiconductor Components Industries, LLC dba ON Semiconductor or its subsidiaries in the United States and/or other countries. ON Semiconductor reserves the right to make changes without further notice to any products herein. ON Semiconductor makes no warranty, representation or guarantee regarding the suitability of its products for any particular purpose, nor does ON Semiconductor assume any liability arising out of the application or use of any product or circuit, and specifically disclaims any and all liability, including without limitation special, consequential or incidental damages. ON Semiconductor does not convey any license under its patent rights nor the rights of others.

**onsemi**, **Onsemi**, and other names, marks, and brands are registered and/or common law trademarks of Semiconductor Components Industries, LLC dba "**onsemi**" or its affiliates and/or subsidiaries in the United States and/or other countries. **onsemi** owns the rights to a number of patents, trademarks, copyrights, trade secrets, and other intellectual property. A listing of **onsemi**'s product/patent coverage may be accessed at [www.onsemi.com/site/pdf/Patent-Marking.pdf](http://www.onsemi.com/site/pdf/Patent-Marking.pdf). **onsemi** reserves the right to make changes at any time to any products or information herein, without notice. The information herein is provided "as-is" and **onsemi** makes no warranty, representation or guarantee regarding the accuracy of the information, product features, availability, functionality, or suitability of its products for any particular purpose, nor does **onsemi** assume any liability arising out of the application or use of any product or circuit, and specifically disclaims any and all liability, including without limitation special, consequential or incidental damages. Buyer is responsible for its products and applications using **onsemi** products, including compliance with all laws, regulations and safety requirements or standards, regardless of any support or applications information provided by **onsemi**. "Typical" parameters which may be provided in **onsemi** data sheets and/or specifications can and do vary in different applications and actual performance may vary over time. All operating parameters, including "Typicals" must be validated for each customer application by customer's technical experts. **onsemi** does not convey any license under any of its intellectual property rights nor the rights of others. **onsemi** products are not designed, intended, or authorized for use as a critical component in life support systems or any FDA Class 3 medical devices or medical devices with a same or similar classification in a foreign jurisdiction or any devices intended for implantation in the human body. Should Buyer purchase or use **onsemi** products for any such unintended or unauthorized application, Buyer shall indemnify and hold **onsemi** and its officers, employees, subsidiaries, affiliates, and distributors harmless against all claims, costs, damages, and expenses, and reasonable attorney fees arising out of, directly or indirectly, any claim of personal injury or death associated with such unintended or unauthorized use, even if such claim alleges that **onsemi** was negligent regarding the design or manufacture of the part. **onsemi** is an Equal Opportunity/Affirmative Action Employer. This literature is subject to all applicable copyright laws and is not for resale in any manner.

## ADDITIONAL INFORMATION

### TECHNICAL PUBLICATIONS:

Technical Library: [www.onsemi.com/design/resources/technical-documentation](http://www.onsemi.com/design/resources/technical-documentation)  
onsemi Website: [www.onsemi.com](http://www.onsemi.com)

### ONLINE SUPPORT: [www.onsemi.com/support](http://www.onsemi.com/support)

For additional information, please contact your local Sales Representative at [www.onsemi.com/support/sales](http://www.onsemi.com/support/sales)