

BUV22

Switch-mode Series NPN Silicon Power Transistor

This device is designed for high speed, high current, high power applications.

Features

- High DC Current Gain:
 $h_{FE} \text{ min} = 20$ at $I_C = 10 \text{ A}$
- Low $V_{CE(sat)}$, $V_{CE(sat)}$
 $\text{max} = 1.0 \text{ V}$ at $I_C = 10 \text{ A}$
- Very Fast Switching Times:
 $TF \text{ max} = 0.35 \mu\text{s}$ at $I_C = 20 \text{ A}$
- Pb-Free Package is Available*

MAXIMUM RATINGS

Rating	Symbol	Value	Unit
Collector-Emitter Voltage	$V_{CEO(SUS)}$	250	Vdc
Collector-Base Voltage	V_{CBO}	300	Vdc
Emitter-Base Voltage	V_{EBO}	7	Vdc
Collector-Emitter Voltage ($V_{BE} = -1.5 \text{ V}$)	V_{CEX}	300	Vdc
Collector-Emitter Voltage ($R_{BE} = 100 \Omega$)	V_{CER}	290	Vdc
Collector-Current - Continuous	I_C	40	Adc
- Peak ($PW \leq 10 \text{ ms}$)	I_{CM}	50	Apk
Base-Current Continuous	I_B	8	Adc
Total Device Dissipation @ $T_C = 25^\circ\text{C}$	P_D	250	W
Operating and Storage Junction Temperature Range	T_J, T_{stg}	-65 to 200	$^\circ\text{C}$

THERMAL CHARACTERISTICS

Characteristics	Symbol	Max	Unit
Thermal Resistance, Junction-to-Case	θ_{JC}	0.7	$^\circ\text{C/W}$

Maximum ratings are those values beyond which device damage can occur. Maximum ratings applied to the device are individual stress limit values (not normal operating conditions) and are not valid simultaneously. If these limits are exceeded, device functional operation is not implied, damage may occur and reliability may be affected.

*For additional information on our Pb-Free strategy and soldering details, please download the ON Semiconductor Soldering and Mounting Techniques Reference Manual, SOLDERRM/D.



ON Semiconductor®

<http://onsemi.com>

**40 AMPERES
NPN SILICON POWER
METAL TRANSISTOR
250 VOLTS – 250 WATTS**

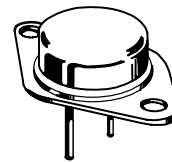

TO-204AE (TO-3)
CASE 197A

MARKING DIAGRAM



BUV22 = Device Code
G = Pb-Free Package
A = Assembly Location
Y = Year
WW = Work Week
MEX = Country of Origin

ORDERING INFORMATION

Device	Package	Shipping
BUV22	TO-204	100 Units / Tray
BUV22G	TO-204 (Pb-Free)	100 Units / Tray

BUV22

ELECTRICAL CHARACTERISTICS (T_C = 25°C unless otherwise noted)

Characteristic	Symbol	Min	Max	Unit
OFF CHARACTERISTICS (Note 1)				
Collector–Emitter Sustaining Voltage (I _C = 200 mA, I _B = 0, L = 25 mH)	V _{CEO(sus)}	250		Vdc
Collector Cutoff Current at Reverse Bias (V _{CE} = 300 V, V _{BE} = -1.5 V) (V _{CE} = 300 V, V _{BE} = -1.5 V, T _C = 125°C)	I _{CEx}		3.0 12.0	mAdc
Collector–Emitter Cutoff Current (V _{CE} = 200 V)	I _{CEO}		3.0	mAdc
Emitter–Base Reverse Voltage (I _E = 50 mA)	V _{EBO}	7		V
Emitter–Cutoff Current (V _{EB} = 5 V)	I _{EBO}		1.0	mAdc

SECOND BREAKDOWN

Second Breakdown Collector Current with base forward biased (V _{CE} = 20 V, t = 1 s) (V _{CE} = 140 V, t = 1 s)	I _{S/b}	12 0.15		Adc
--	------------------	------------	--	-----

ON CHARACTERISTICS

 (Note 1)

DC Current Gain (I _C = 10 A, V _{CE} = 4 V) (I _C = 20 A, V _{CE} = 4 V)	h _{FE}	20 10	60	
Collector–Emitter Saturation Voltage (I _C = 10 A, I _B = 1 A) (I _C = 20 A, I _B = 2.5 A)	V _{CE(sat)}		1.0 1.5	Vdc
Base–Emitter Saturation Voltage (I _C = 40 A, I _B = 4 A)	V _{BE(sat)}		1.5	Vdc

DYNAMIC CHARACTERISTICS

Current Gain — Bandwidth Product (V _{CE} = 15 V, I _C = 2 A, f = 4 MHz)	f _T	8.0		MHz
---	----------------	-----	--	-----

SWITCHING CHARACTERISTICS

 (Resistive Load)

Turn-on Time	(I _C = 20 A, I _{B1} = I _{B2} = 2.5 A, V _{CC} = 100 V, R _C = 5 Ω)	t _{on}	0.8	μs
Storage Time		t _s	2.0	
Fall Time		t _f	0.35	

1. Pulse Test: Pulse Width ≤ 300 μs, Duty Cycle ≤ 2%.

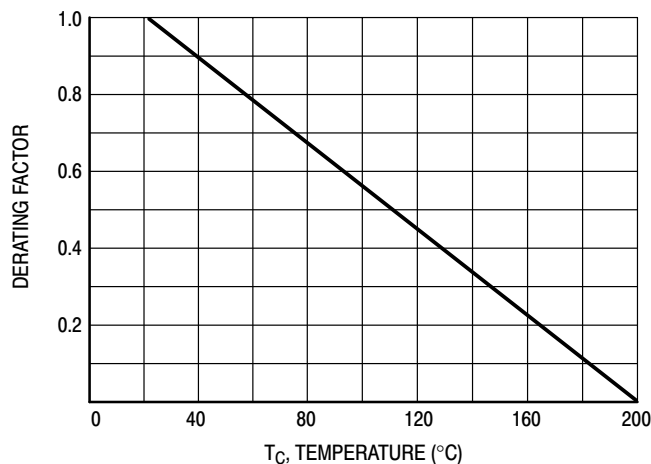

Figure 1. Power Derating

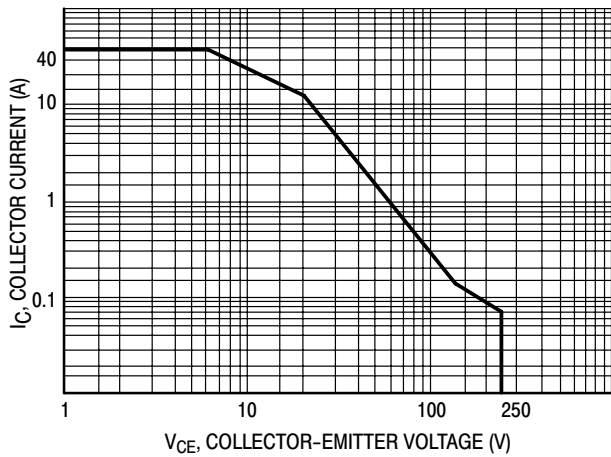

Figure 2. Active Region Safe Operating Area

There are two limitations on the power handling ability of a transistor: average junction temperature and second breakdown. Safe operating area curves indicate $I_C - V_{CE}$ limits of the transistor that must be observed for reliable operation i.e., the transistor must not be subjected to greater dissipation than the curves indicate.

The data of Figure 2 is based on $T_C = 25^\circ\text{C}$; $T_{J(pk)}$ is variable depending on power level. Second breakdown limitations do not derate the same as thermal limitations.

At high case temperatures, thermal limitations will reduce the power that can handled to values less than the limitations imposed by second breakdown.

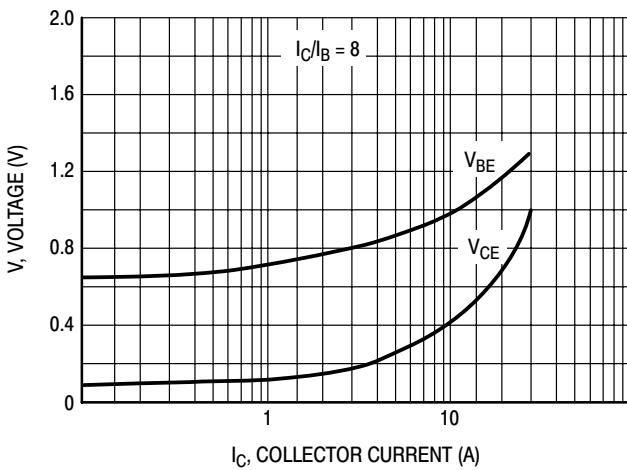

Figure 3. "On" Voltages

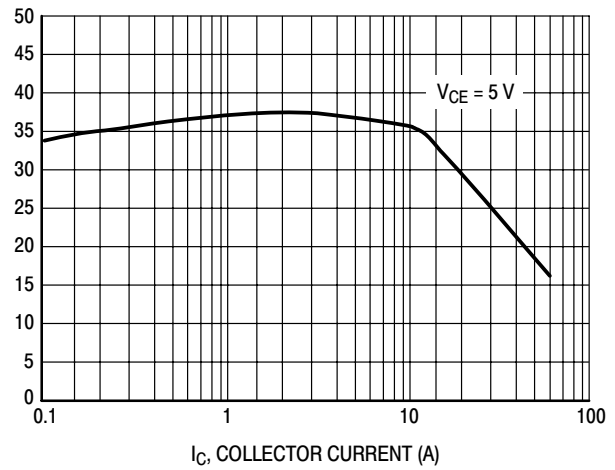

Figure 4. DC Current Gain

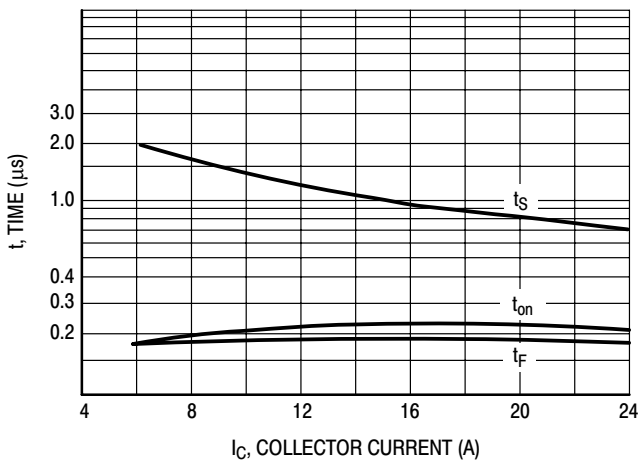

Figure 5. Resistive Switching Performance

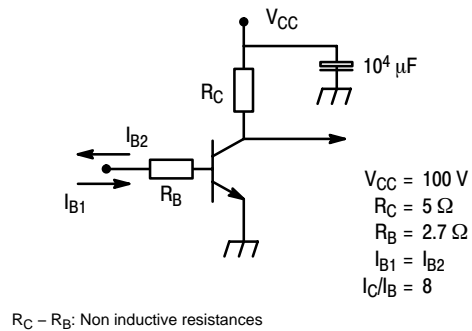
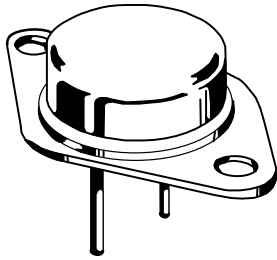

Figure 6. Switching Times Test Circuit

MECHANICAL CASE OUTLINE

PACKAGE DIMENSIONS

ON Semiconductor®



TO-204 (TO-3)
CASE 197A-05
ISSUE K

DATE 21 FEB 2000

SCALE 1:1

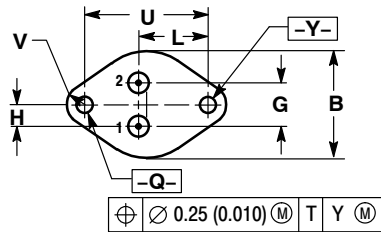
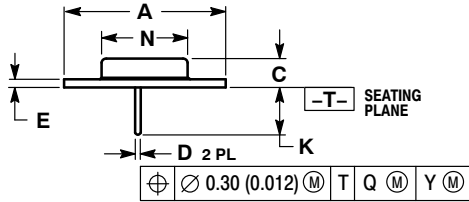

STYLE 1:
PIN 1. BASE
2. EMITTER
CASE: COLLECTOR

STYLE 2:
PIN 1. EMITTER
2. BASE
CASE: COLLECTOR

STYLE 3:
PIN 1. GATE
2. SOURCE
CASE: DRAIN

STYLE 4:
PIN 1. ANODE = 1
2. ANODE = 2
CASE: CATHODES

- NOTES:
1. DIMENSIONING AND TOLERANCING PER ANSI Y14.5M, 1982.
2. CONTROLLING DIMENSION: INCH.

DIM	INCHES		MILLIMETERS	
	MIN	MAX	MIN	MAX
A	1.530 REF		38.86 REF	
B	0.990	1.050	25.15	26.67
C	0.250	0.335	6.35	8.51
D	0.057	0.063	1.45	1.60
E	0.060	0.070	1.53	1.77
G	0.430 BSC		10.92 BSC	
H	0.215 BSC		5.46 BSC	
K	0.440	0.480	11.18	12.19
L	0.665 BSC		16.89 BSC	
N	0.760	0.830	19.31	21.08
Q	0.151	0.165	3.84	4.19
U	1.187 BSC		30.15 BSC	
V	0.131	0.188	3.33	4.77

GENERIC MARKING DIAGRAM*

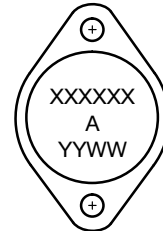

XXXXXX = Specific Device Code
A = Assembly Location
YY = Year
WW = Work Week

*This information is generic. Please refer to device data sheet for actual part marking.

DOCUMENT NUMBER:	98ASB42128B	Electronic versions are uncontrolled except when accessed directly from the Document Repository. Printed versions are uncontrolled except when stamped "CONTROLLED COPY" in red.
STATUS:	ON SEMICONDUCTOR STANDARD	
NEW STANDARD:		
DESCRIPTION:	TO-204 (TO-3)	PAGE 1 OF 2



ISSUE	REVISION	DATE
K	LEGALLY CHANGED TO ON	21 FEB 2000

ON Semiconductor and **ON** are registered trademarks of Semiconductor Components Industries, LLC (SCILLC). SCILLC reserves the right to make changes without further notice to any products herein. SCILLC makes no warranty, representation or guarantee regarding the suitability of its products for any particular purpose, nor does SCILLC assume any liability arising out of the application or use of any product or circuit, and specifically disclaims any and all liability, including without limitation special, consequential or incidental damages. "Typical" parameters which may be provided in SCILLC data sheets and/or specifications can and do vary in different applications and actual performance may vary over time. All operating parameters, including "Typicals" must be validated for each customer application by customer's technical experts. SCILLC does not convey any license under its patent rights nor the rights of others. SCILLC products are not designed, intended, or authorized for use as components in systems intended for surgical implant into the body, or other applications intended to support or sustain life, or for any other application in which the failure of the SCILLC product could create a situation where personal injury or death may occur. Should Buyer purchase or use SCILLC products for any such unintended or unauthorized application, Buyer shall indemnify and hold SCILLC and its officers, employees, subsidiaries, affiliates, and distributors harmless against all claims, costs, damages, and expenses, and reasonable attorney fees arising out of, directly or indirectly, any claim of personal injury or death associated with such unintended or unauthorized use, even if such claim alleges that SCILLC was negligent regarding the design or manufacture of the part. SCILLC is an Equal Opportunity/Affirmative Action Employer.

onsemi, **Onsemi**, and other names, marks, and brands are registered and/or common law trademarks of Semiconductor Components Industries, LLC dba "**onsemi**" or its affiliates and/or subsidiaries in the United States and/or other countries. **onsemi** owns the rights to a number of patents, trademarks, copyrights, trade secrets, and other intellectual property. A listing of **onsemi**'s product/patent coverage may be accessed at www.onsemi.com/site/pdf/Patent-Marking.pdf. **onsemi** reserves the right to make changes at any time to any products or information herein, without notice. The information herein is provided "as-is" and **onsemi** makes no warranty, representation or guarantee regarding the accuracy of the information, product features, availability, functionality, or suitability of its products for any particular purpose, nor does **onsemi** assume any liability arising out of the application or use of any product or circuit, and specifically disclaims any and all liability, including without limitation special, consequential or incidental damages. Buyer is responsible for its products and applications using **onsemi** products, including compliance with all laws, regulations and safety requirements or standards, regardless of any support or applications information provided by **onsemi**. "Typical" parameters which may be provided in **onsemi** data sheets and/or specifications can and do vary in different applications and actual performance may vary over time. All operating parameters, including "Typicals" must be validated for each customer application by customer's technical experts. **onsemi** does not convey any license under any of its intellectual property rights nor the rights of others. **onsemi** products are not designed, intended, or authorized for use as a critical component in life support systems or any FDA Class 3 medical devices or medical devices with a same or similar classification in a foreign jurisdiction or any devices intended for implantation in the human body. Should Buyer purchase or use **onsemi** products for any such unintended or unauthorized application, Buyer shall indemnify and hold **onsemi** and its officers, employees, subsidiaries, affiliates, and distributors harmless against all claims, costs, damages, and expenses, and reasonable attorney fees arising out of, directly or indirectly, any claim of personal injury or death associated with such unintended or unauthorized use, even if such claim alleges that **onsemi** was negligent regarding the design or manufacture of the part. **onsemi** is an Equal Opportunity/Affirmative Action Employer. This literature is subject to all applicable copyright laws and is not for resale in any manner.

ADDITIONAL INFORMATION

TECHNICAL PUBLICATIONS:

Technical Library: www.onsemi.com/design/resources/technical-documentation
onsemi Website: www.onsemi.com

ONLINE SUPPORT: www.onsemi.com/support

For additional information, please contact your local Sales Representative at www.onsemi.com/support/sales