

# MPSA13, MPSA14

MPSA14 is a Preferred Device

## Darlington Transistors

### NPN Silicon

#### Features

- Pb-Free Packages are Available\*

#### MAXIMUM RATINGS

| Rating   | Symbol         | Value       | Unit                       |
|--|----------------|-------------|----------------------------|
| Collector–Emitter Voltage  | $V_{CES}$      | 30          | Vdc                        |
| Collector–Base Voltage   | $V_{CBO}$      | 30          | Vdc                        |
| Emitter–Base Voltage   | $V_{EBO}$      | 10          | Vdc                        |
| Collector Current – Continuous   | $I_C$          | 500         | mAdc                       |
| Total Device Dissipation @ $T_A = 25^\circ\text{C}$<br>Derate above $25^\circ\text{C}$ | $P_D$          | 625<br>5.0  | mW<br>mW/ $^\circ\text{C}$ |
| Total Device Dissipation @ $T_C = 25^\circ\text{C}$<br>Derate above $25^\circ\text{C}$ | $P_D$          | 1.5<br>12   | W<br>mW/ $^\circ\text{C}$  |
| Operating and Storage Junction<br>Temperature Range                                    | $T_J, T_{stg}$ | -55 to +150 | $^\circ\text{C}$           |

#### THERMAL CHARACTERISTICS

| Characteristic                          | Symbol          | Max  | Unit                       |
|---|-----------------|------|----------------------------|
| Thermal Resistance, Junction-to-Ambient | $R_{\theta JA}$ | 200  | $^\circ\text{C}/\text{mW}$ |
| Thermal Resistance, Junction-to-Case    | $R_{\theta JC}$ | 83.3 | $^\circ\text{C}/\text{mW}$ |

Stresses exceeding Maximum Ratings may damage the device. Maximum Ratings are stress ratings only. Functional operation above the Recommended Operating Conditions is not implied. Extended exposure to stresses above the Recommended Operating Conditions may affect device reliability.

\*For additional information on our Pb-Free strategy and soldering details, please download the ON Semiconductor Soldering and Mounting Techniques Reference Manual, SOLDERRM/D.



ON Semiconductor®

<http://onsemi.com>

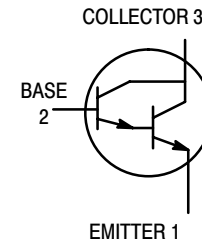

TO-92  
CASE 29  
STYLE 1

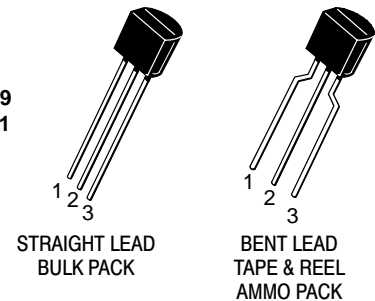

#### MARKING DIAGRAM

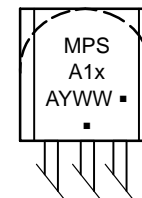

- x = 3 or 4
- A = Assembly Location
- Y = Year
- WW = Work Week
- = Pb-Free Package

(Note: Microdot may be in either location)

#### ORDERING INFORMATION

See detailed ordering and shipping information in the package dimensions section on page 2 of this data sheet.

Preferred devices are recommended choices for future use and best overall value.

# MPSA13, MPSA14

## ELECTRICAL CHARACTERISTICS (T<sub>A</sub> = 25°C unless otherwise noted)

| Characteristic   | Symbol               | Min                                 | Max              | Unit |
|--|----------------------|-------------------------------------|------------------|------|
| <b>OFF CHARACTERISTICS</b>   |                      |                                     |                  |      |
| Collector–Emitter Breakdown Voltage<br>(I <sub>C</sub> = 100 μAdc, I <sub>B</sub> = 0)   | V <sub>(BR)CES</sub> | 30                                  | –                | Vdc  |
| Collector Cutoff Current<br>(V <sub>CB</sub> = 30 Vdc, I <sub>E</sub> = 0)   | I <sub>CBO</sub>     | –                                   | 100              | nAdc |
| Emitter Cutoff Current<br>(V <sub>EB</sub> = 10 Vdc, I <sub>C</sub> = 0)   | I <sub>EBO</sub>     | –                                   | 100              | nAdc |
| <b>ON CHARACTERISTICS (Note 1)</b>   |                      |                                     |                  |      |
| DC Current Gain<br>(I <sub>C</sub> = 10 mAdc, V <sub>CE</sub> = 5.0 Vdc)<br><br>(I <sub>C</sub> = 100 mAdc, V <sub>CE</sub> = 5.0 Vdc) | h <sub>FE</sub>      | 5,000<br>10,000<br>10,000<br>20,000 | –<br>–<br>–<br>– | –    |
| Collector–Emitter Saturation Voltage<br>(I <sub>C</sub> = 100 mAdc, I <sub>B</sub> = 0.1 mAdc)   | V <sub>CE(sat)</sub> | –                                   | 1.5              | Vdc  |
| Base–Emitter On Voltage<br>(I <sub>C</sub> = 100 mAdc, V <sub>CE</sub> = 5.0 Vdc)  | V <sub>BE(on)</sub>  | –                                   | 2.0              | Vdc  |
| <b>SMALL–SIGNAL CHARACTERISTICS</b>  |                      |                                     |                  |      |
| Current–Gain – Bandwidth Product (Note 2)<br>(I <sub>C</sub> = 10 mAdc, V <sub>CE</sub> = 5.0 Vdc, f = 100 MHz)                        | f <sub>T</sub>       | 125                                 | –                | MHz  |

1. Pulse Test: Pulse Width ≤ 300 μs; Duty Cycle ≤ 2.0%.
2. f<sub>T</sub> = |h<sub>fe</sub>| • f<sub>test</sub>.

## ORDERING INFORMATION

| Device      | Package            | Shipping <sup>†</sup> |
|-------------|--------------------|-----------------------|
| MPSA13      | TO–92              | 5000 Units / Bulk     |
| MPSA13G     | TO–92<br>(Pb–Free) | 5000 Units / Bulk     |
| MPSA13RLRA  | TO–92              | 2000 / Tape & Reel    |
| MPSA13RLRAG | TO–92<br>(Pb–Free) | 2000 / Tape & Reel    |
| MPSA13RLRMG | TO–92<br>(Pb–Free) | 2000 / Ammo Pack      |
| MPSA13RLRPG | TO–92<br>(Pb–Free) | 2000 / Ammo Pack      |
| MPSA13ZL1G  | TO–92<br>(Pb–Free) | 2000 / Ammo Pack      |
| MPSA14G     | TO–92<br>(Pb–Free) | 5000 Units / Bulk     |
| MPSA14RLRAG | TO–92<br>(Pb–Free) | 2000 / Tape & Reel    |
| MPSA14RLRPG | TO–92<br>(Pb–Free) | 2000 / Ammo Pack      |

<sup>†</sup>For information on tape and reel specifications, including part orientation and tape sizes, please refer to our Tape and Reel Packaging Specifications Brochure, BRD8011/D.

# MPSA13, MPSA14

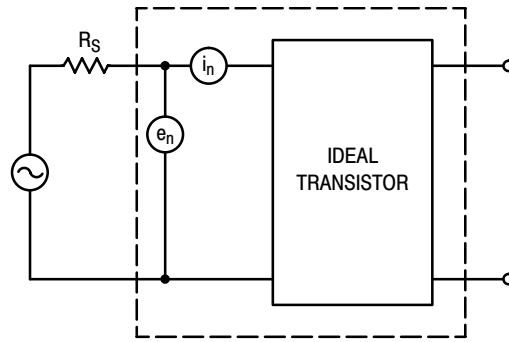

Figure 1. Transistor Noise Model

## NOISE CHARACTERISTICS

( $V_{CE} = 5.0$  Vdc,  $T_A = 25^\circ\text{C}$ )

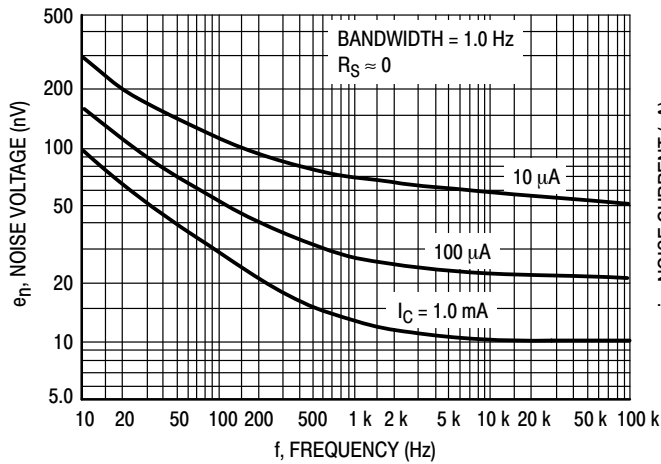

Figure 2. Noise Voltage

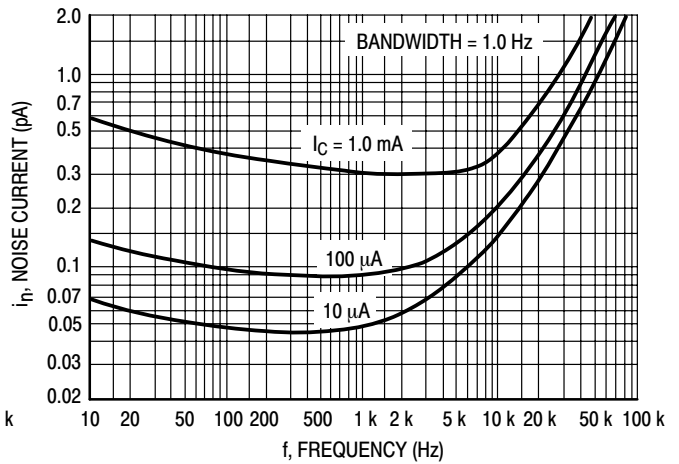

Figure 3. Noise Current

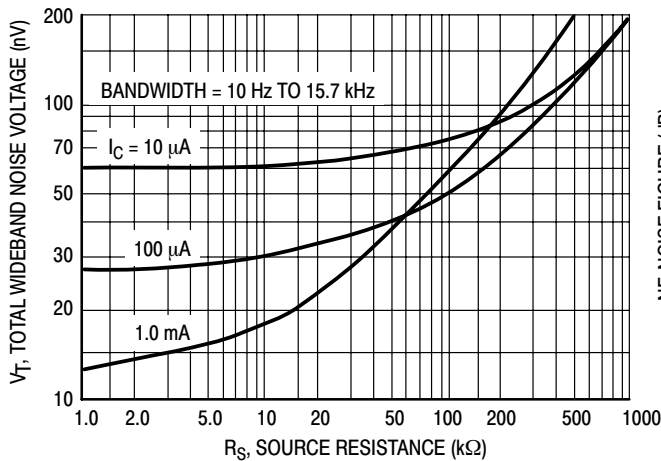

Figure 4. Total Wideband Noise Voltage

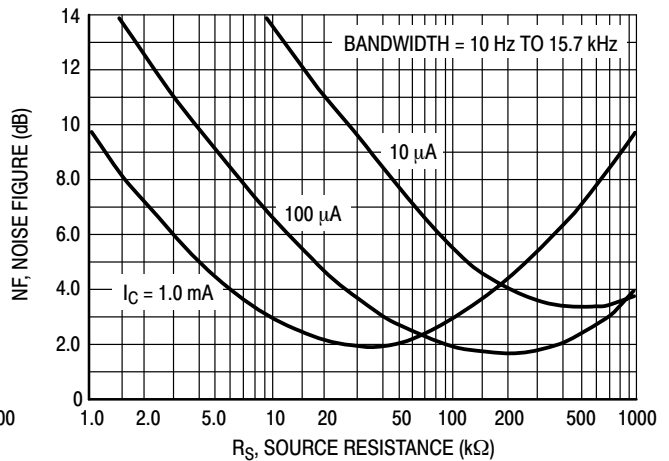

Figure 5. Wideband Noise Figure

# MPSA13, MPSA14

## SMALL-SIGNAL CHARACTERISTICS

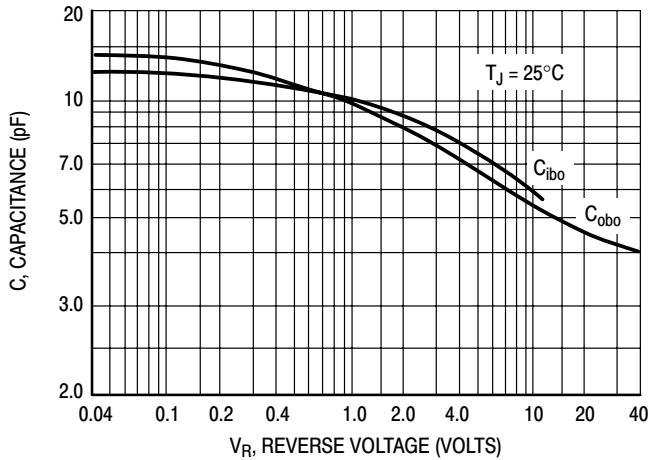

Figure 6. Capacitance

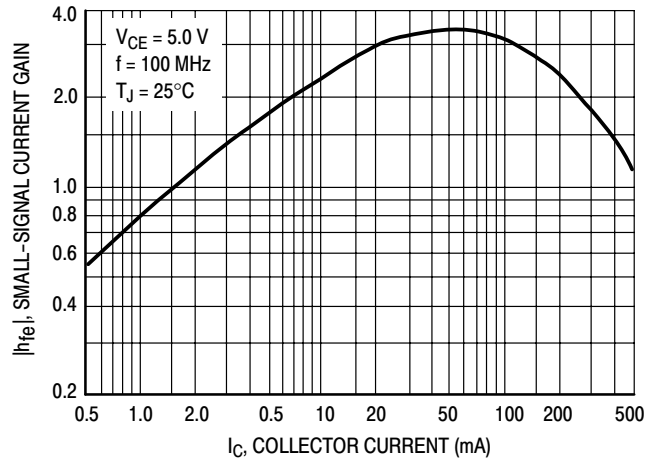

Figure 7. High Frequency Current Gain

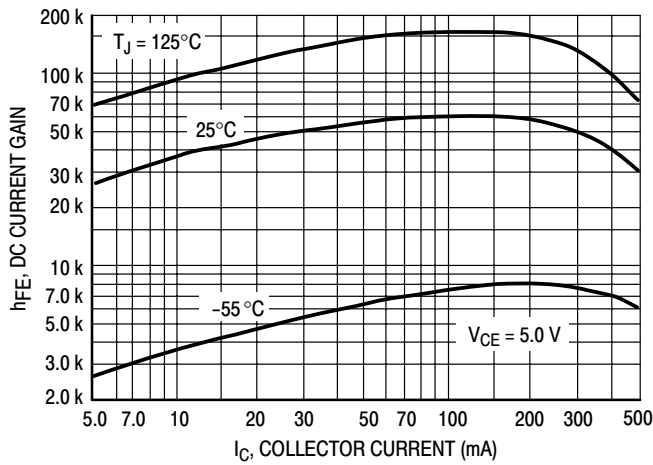

Figure 8. DC Current Gain

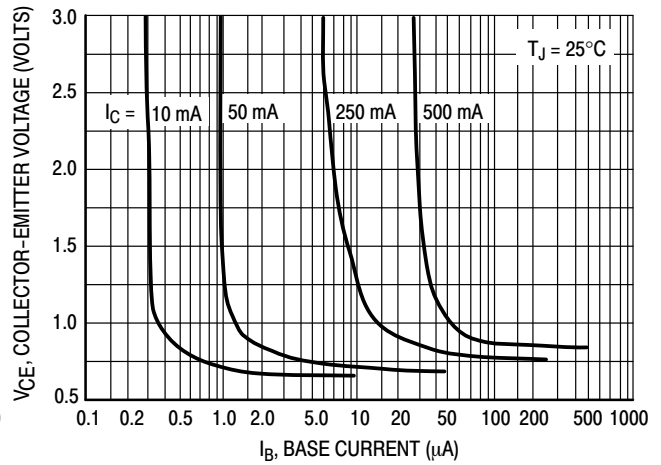

Figure 9. Collector Saturation Region

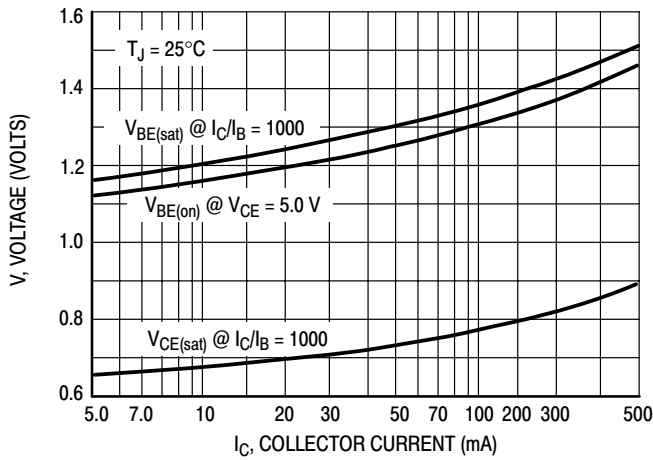

Figure 10. "On" Voltages

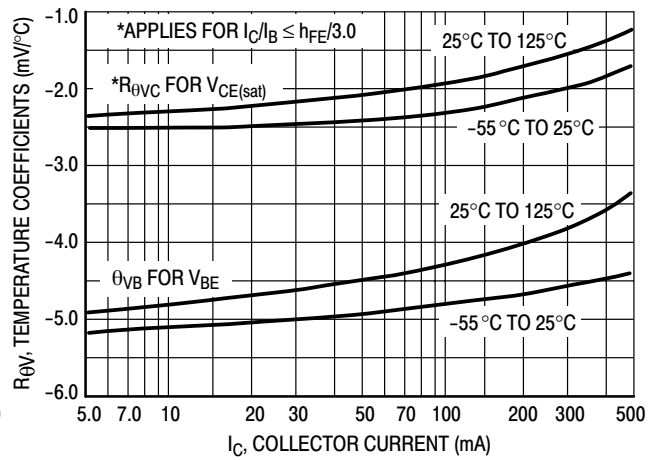

Figure 11. Temperature Coefficients

# MPSA13, MPSA14

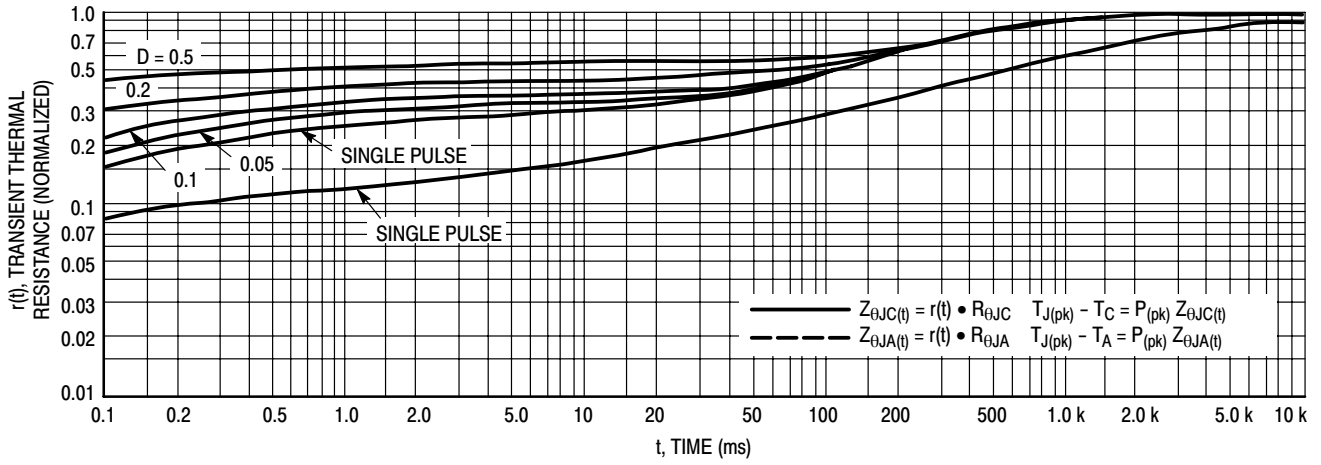

Figure 12. Thermal Response

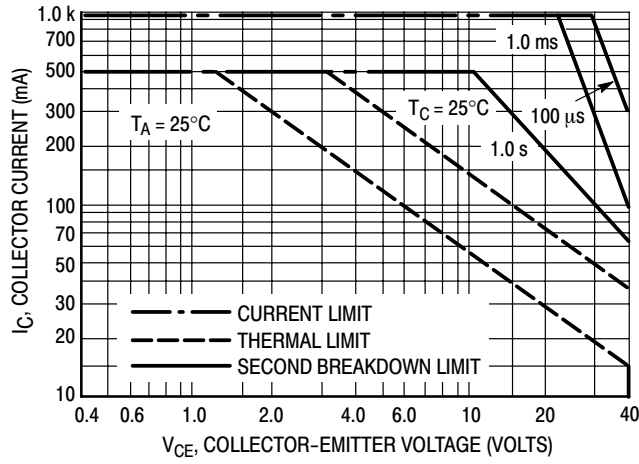
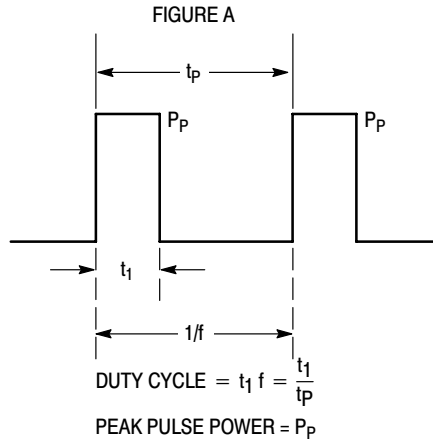

Figure 13. Active Region Safe Operating Area



Design Note: Use of Transient Thermal Resistance Data

# MECHANICAL CASE OUTLINE PACKAGE DIMENSIONS

ON Semiconductor®



SCALE 1:1

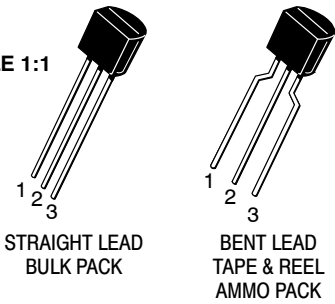

TO-92 (TO-226)  
CASE 29-11  
ISSUE AM

DATE 09 MAR 2007

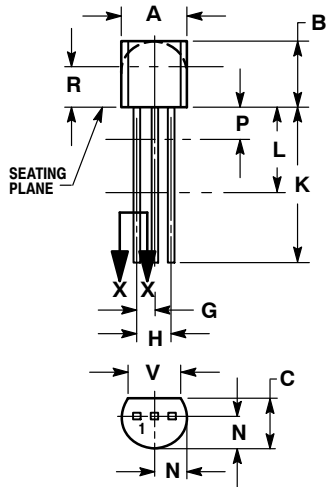

STRAIGHT LEAD  
BULK PACK

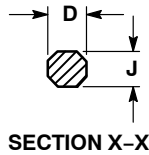

NOTES:

1. DIMENSIONING AND TOLERANCING PER ANSI Y14.5M, 1982.
2. CONTROLLING DIMENSION: INCH.
3. CONTOUR OF PACKAGE BEYOND DIMENSION R IS UNCONTROLLED.
4. LEAD DIMENSION IS UNCONTROLLED IN P AND BEYOND DIMENSION K MINIMUM.

| DIM | INCHES |       | MILLIMETERS |       |
|-----|--------|-------|-------------|-------|
|     | MIN    | MAX   | MIN         | MAX   |
| A   | 0.175  | 0.205 | 4.45        | 5.20  |
| B   | 0.170  | 0.210 | 4.32        | 5.33  |
| C   | 0.125  | 0.165 | 3.18        | 4.19  |
| D   | 0.016  | 0.021 | 0.407       | 0.533 |
| G   | 0.045  | 0.055 | 1.15        | 1.39  |
| H   | 0.095  | 0.105 | 2.42        | 2.66  |
| J   | 0.015  | 0.020 | 0.39        | 0.50  |
| K   | 0.500  | ---   | 12.70       | ---   |
| L   | 0.250  | ---   | 6.35        | ---   |
| N   | 0.080  | 0.105 | 2.04        | 2.66  |
| P   | ---    | 0.100 | ---         | 2.54  |
| R   | 0.115  | ---   | 2.93        | ---   |
| V   | 0.135  | ---   | 3.43        | ---   |

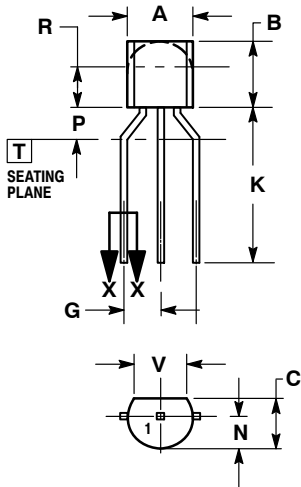

BENT LEAD  
TAPE & REEL  
AMMO PACK

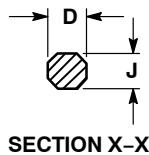

NOTES:

1. DIMENSIONING AND TOLERANCING PER ASME Y14.5M, 1994.
2. CONTROLLING DIMENSION: MILLIMETERS.
3. CONTOUR OF PACKAGE BEYOND DIMENSION R IS UNCONTROLLED.
4. LEAD DIMENSION IS UNCONTROLLED IN P AND BEYOND DIMENSION K MINIMUM.

| DIM | MILLIMETERS |      |
|-----|-------------|------|
|     | MIN         | MAX  |
| A   | 4.45        | 5.20 |
| B   | 4.32        | 5.33 |
| C   | 3.18        | 4.19 |
| D   | 0.40        | 0.54 |
| G   | 2.40        | 2.80 |
| J   | 0.39        | 0.50 |
| K   | 12.70       | ---  |
| N   | 2.04        | 2.66 |
| P   | 1.50        | 4.00 |
| R   | 2.93        | ---  |
| V   | 3.43        | ---  |

STYLES ON PAGE 2

|                  |                           |  |
|------------------|---------------------------|--|
| DOCUMENT NUMBER: | 98ASB42022B               | Electronic versions are uncontrolled except when accessed directly from the Document Repository. Printed versions are uncontrolled except when stamped "CONTROLLED COPY" in red. |
| STATUS:          | ON SEMICONDUCTOR STANDARD |  |
| NEW STANDARD:    |                           |  |
| DESCRIPTION:     | TO-92 (TO-226)            | PAGE 1 OF 3  |

**TO-92 (TO-226)**  
**CASE 29-11**  
**ISSUE AM**

DATE 09 MAR 2007

STYLE 1:  
 PIN 1. EMITTER  
 2. BASE  
 3. COLLECTOR

STYLE 2:  
 PIN 1. BASE  
 2. EMITTER  
 3. COLLECTOR

STYLE 3:  
 PIN 1. ANODE  
 2. ANODE  
 3. CATHODE

STYLE 4:  
 PIN 1. CATHODE  
 2. CATHODE  
 3. ANODE

STYLE 5:  
 PIN 1. DRAIN  
 2. SOURCE  
 3. GATE

STYLE 6:  
 PIN 1. GATE  
 2. SOURCE & SUBSTRATE  
 3. DRAIN

STYLE 7:  
 PIN 1. SOURCE  
 2. DRAIN  
 3. GATE

STYLE 8:  
 PIN 1. DRAIN  
 2. GATE  
 3. SOURCE & SUBSTRATE

STYLE 9:  
 PIN 1. BASE 1  
 2. EMITTER  
 3. BASE 2

STYLE 10:  
 PIN 1. CATHODE  
 2. GATE  
 3. ANODE

STYLE 11:  
 PIN 1. ANODE  
 2. CATHODE & ANODE  
 3. CATHODE

STYLE 12:  
 PIN 1. MAIN TERMINAL 1  
 2. GATE  
 3. MAIN TERMINAL 2

STYLE 13:  
 PIN 1. ANODE 1  
 2. GATE  
 3. CATHODE 2

STYLE 14:  
 PIN 1. EMITTER  
 2. COLLECTOR  
 3. BASE

STYLE 15:  
 PIN 1. ANODE 1  
 2. CATHODE  
 3. ANODE 2

STYLE 16:  
 PIN 1. ANODE  
 2. GATE  
 3. CATHODE

STYLE 17:  
 PIN 1. COLLECTOR  
 2. BASE  
 3. EMITTER

STYLE 18:  
 PIN 1. ANODE  
 2. CATHODE  
 3. NOT CONNECTED

STYLE 19:  
 PIN 1. GATE  
 2. ANODE  
 3. CATHODE

STYLE 20:  
 PIN 1. NOT CONNECTED  
 2. CATHODE  
 3. ANODE

STYLE 21:  
 PIN 1. COLLECTOR  
 2. EMITTER  
 3. BASE

STYLE 22:  
 PIN 1. SOURCE  
 2. GATE  
 3. DRAIN

STYLE 23:  
 PIN 1. GATE  
 2. SOURCE  
 3. DRAIN

STYLE 24:  
 PIN 1. EMITTER  
 2. COLLECTOR/ANODE  
 3. CATHODE

STYLE 25:  
 PIN 1. MT 1  
 2. GATE  
 3. MT 2

STYLE 26:  
 PIN 1. V<sub>CC</sub>  
 2. GROUND 2  
 3. OUTPUT

STYLE 27:  
 PIN 1. MT  
 2. SUBSTRATE  
 3. MT

STYLE 28:  
 PIN 1. CATHODE  
 2. ANODE  
 3. GATE

STYLE 29:  
 PIN 1. NOT CONNECTED  
 2. ANODE  
 3. CATHODE

STYLE 30:  
 PIN 1. DRAIN  
 2. GATE  
 3. SOURCE

STYLE 31:  
 PIN 1. GATE  
 2. DRAIN  
 3. SOURCE

STYLE 32:  
 PIN 1. BASE  
 2. COLLECTOR  
 3. EMITTER

STYLE 33:  
 PIN 1. RETURN  
 2. INPUT  
 3. OUTPUT

STYLE 34:  
 PIN 1. INPUT  
 2. GROUND  
 3. LOGIC

STYLE 35:  
 PIN 1. GATE  
 2. COLLECTOR  
 3. EMITTER

|                         |                                  |  |
|-------------------------|----------------------------------|--|
| <b>DOCUMENT NUMBER:</b> | <b>98ASB42022B</b>               | Electronic versions are uncontrolled except when accessed directly from the Document Repository. Printed versions are uncontrolled except when stamped "CONTROLLED COPY" in red. |
| <b>STATUS:</b>          | <b>ON SEMICONDUCTOR STANDARD</b> |  |
| <b>NEW STANDARD:</b>    |                                  |  |
| <b>DESCRIPTION:</b>     | <b>TO-92 (TO-226)</b>            | <b>PAGE 2 OF 3</b>   |



| ISSUE | REVISION  | DATE        |
|-------|---|-------------|
| AM    | ADDED BENT-LEAD TAPE & REEL VERSION. REQ. BY J. SUPINA. | 09 MAR 2007 |
|       |   |             |
|       |   |             |
|       |   |             |
|       |   |             |
|       |   |             |
|       |   |             |
|       |   |             |
|       |   |             |
|       |   |             |
|       |   |             |
|       |   |             |
|       |   |             |
|       |   |             |
|       |   |             |
|       |   |             |
|       |   |             |
|       |   |             |
|       |   |             |
|       |   |             |
|       |   |             |
|       |   |             |
|       |   |             |

ON Semiconductor and are registered trademarks of Semiconductor Components Industries, LLC (SCILLC). SCILLC reserves the right to make changes without further notice to any products herein. SCILLC makes no warranty, representation or guarantee regarding the suitability of its products for any particular purpose, nor does SCILLC assume any liability arising out of the application or use of any product or circuit, and specifically disclaims any and all liability, including without limitation special, consequential or incidental damages. "Typical" parameters which may be provided in SCILLC data sheets and/or specifications can and do vary in different applications and actual performance may vary over time. All operating parameters, including "Typicals" must be validated for each customer application by customer's technical experts. SCILLC does not convey any license under its patent rights nor the rights of others. SCILLC products are not designed, intended, or authorized for use as components in systems intended for surgical implant into the body, or other applications intended to support or sustain life, or for any other application in which the failure of the SCILLC product could create a situation where personal injury or death may occur. Should Buyer purchase or use SCILLC products for any such unintended or unauthorized application, Buyer shall indemnify and hold SCILLC and its officers, employees, subsidiaries, affiliates, and distributors harmless against all claims, costs, damages, and expenses, and reasonable attorney fees arising out of, directly or indirectly, any claim of personal injury or death associated with such unintended or unauthorized use, even if such claim alleges that SCILLC was negligent regarding the design or manufacture of the part. SCILLC is an Equal Opportunity/Affirmative Action Employer. This literature is subject to all applicable copyright laws and is not for resale in any manner.



**onsemi**, **Onsemi**, and other names, marks, and brands are registered and/or common law trademarks of Semiconductor Components Industries, LLC dba "**onsemi**" or its affiliates and/or subsidiaries in the United States and/or other countries. **onsemi** owns the rights to a number of patents, trademarks, copyrights, trade secrets, and other intellectual property. A listing of **onsemi**'s product/patent coverage may be accessed at [www.onsemi.com/site/pdf/Patent-Marking.pdf](http://www.onsemi.com/site/pdf/Patent-Marking.pdf). **onsemi** reserves the right to make changes at any time to any products or information herein, without notice. The information herein is provided "as-is" and **onsemi** makes no warranty, representation or guarantee regarding the accuracy of the information, product features, availability, functionality, or suitability of its products for any particular purpose, nor does **onsemi** assume any liability arising out of the application or use of any product or circuit, and specifically disclaims any and all liability, including without limitation special, consequential or incidental damages. Buyer is responsible for its products and applications using **onsemi** products, including compliance with all laws, regulations and safety requirements or standards, regardless of any support or applications information provided by **onsemi**. "Typical" parameters which may be provided in **onsemi** data sheets and/or specifications can and do vary in different applications and actual performance may vary over time. All operating parameters, including "Typicals" must be validated for each customer application by customer's technical experts. **onsemi** does not convey any license under any of its intellectual property rights nor the rights of others. **onsemi** products are not designed, intended, or authorized for use as a critical component in life support systems or any FDA Class 3 medical devices or medical devices with a same or similar classification in a foreign jurisdiction or any devices intended for implantation in the human body. Should Buyer purchase or use **onsemi** products for any such unintended or unauthorized application, Buyer shall indemnify and hold **onsemi** and its officers, employees, subsidiaries, affiliates, and distributors harmless against all claims, costs, damages, and expenses, and reasonable attorney fees arising out of, directly or indirectly, any claim of personal injury or death associated with such unintended or unauthorized use, even if such claim alleges that **onsemi** was negligent regarding the design or manufacture of the part. **onsemi** is an Equal Opportunity/Affirmative Action Employer. This literature is subject to all applicable copyright laws and is not for resale in any manner.

## ADDITIONAL INFORMATION

### TECHNICAL PUBLICATIONS:

Technical Library: [www.onsemi.com/design/resources/technical-documentation](http://www.onsemi.com/design/resources/technical-documentation)  
onsemi Website: [www.onsemi.com](http://www.onsemi.com)

### ONLINE SUPPORT: [www.onsemi.com/support](http://www.onsemi.com/support)

For additional information, please contact your local Sales Representative at [www.onsemi.com/support/sales](http://www.onsemi.com/support/sales)