

Programmable Shunt Regulator

KA431A, KA431L

Description

The KA431A and KA431L are three-terminal adjustable regulators with a guaranteed thermal stability over the operating temperature range. The output voltage can be set to any value between V_{REF} (approximately 2.5 V) and 36 V with two external resistors. These devices have a typical dynamic output impedance of 0.2 Ω . Active output circuitry provides a sharp turn-on characteristic, making these devices excellent replacements for Zener diodes in many applications.

Features

- Programmable Output Voltage to 36 V
- Low Dynamic Output Impedance: 0.2 Ω (Typical)
- Sink Current Capability: 1.0 to 100 mA
- Equivalent Full-Range Temperature Coefficient of 50 ppm/ $^{\circ}$ C (Typical)
- Temperature Compensated for Operation Over Full Rated Operating Temperature Range
- Low Output Noise Voltage
- Fast Turn-on Response

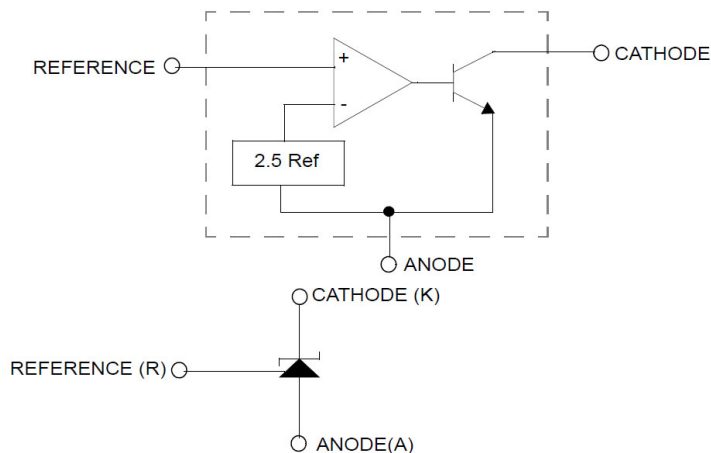
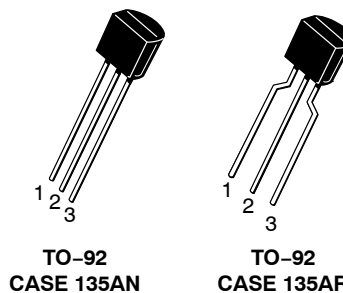

Figure 1. Block Diagram



ON Semiconductor®

www.onsemi.com



MARKING DIAGRAM

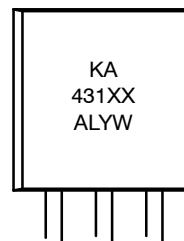

- KA431XX = Specific Device Code
- A = Assembly Location
- L = Wafer Lot
- YW = Assembly Start Week

PIN CONNECTIONS

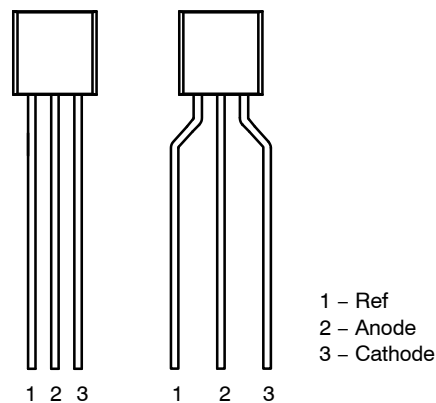

ORDERING INFORMATION

See detailed ordering and shipping information in the package dimensions section on page 6 of this data sheet.

KA431A, KA431L

ABSOLUTE MAXIMUM RATINGS

| Symbol | Parameter | Value | Unit |
|-----------------|---|--------------|------|
| V_{KA} | Cathode Voltage | 37 | V |
| I_{KA} | Cathode Current Range (Continuous) | -100 to +150 | mA |
| I_{REF} | Reference Input Current Range | -0.05 to +10 | mA |
| P_D | Power Dissipation | 770 | mW |
| $R_{\theta JA}$ | Thermal Resistance, Junction to Ambient | 160 | °C/W |
| T_{OPR} | Operating Temperature Range | -25 to +85 | °C |
| T_J | Junction Temperature | 150 | °C |
| T_{STG} | Storage Temperature Range | -65 to +150 | °C |

Stresses exceeding those listed in the Maximum Ratings table may damage the device. If any of these limits are exceeded, device functionality should not be assumed, damage may occur and reliability may be affected.

RECOMMENDED OPERATING CONDITIONS

| Symbol | Parameter | Min | Max | Unit |
|----------|-----------------|-----------|-----|------|
| V_{KA} | Cathode Voltage | V_{REF} | 36 | V |
| I_{KA} | Cathode Current | 1 | 100 | mA |

Functional operation above the stresses listed in the Recommended Operating Ranges is not implied. Extended exposure to stresses beyond the Recommended Operating Ranges limits may affect device reliability.

ELECTRICAL CHARACTERISTICS (Values are at $T_A = 25^\circ\text{C}$ unless otherwise noted)

| Symbol | Parameter | Conditions | KA431A | | | KA431L | | | Unit |
|--|---|--|--------|-------|-------|--------|-------|-------|---------------|
| | | | Min | Typ | Max | Min | Typ | Max | |
| V_{REF} | Reference Input Voltage | $V_{KA} = V_{REF}, I_{KA} = 10\text{ mA}$ | 2.470 | 2.495 | 2.520 | 2.482 | 2.495 | 2.508 | V |
| $\Delta V_{REF}/\Delta T$ | Deviation of Reference Input Voltage Over-Temperature | $V_{KA} = V_{REF}, I_{KA} = 10\text{ mA}$ $T_{MIN} \leq T_A \leq T_{MAX}$ (Note 1) | - | 4.5 | 17.0 | - | 4.5 | 17.0 | mV |
| $\frac{\Delta V_{REF}}{\Delta V_{KA}}$ | Ratio of Change in Reference Input Voltage to the Change in Cathode Voltage | $I_{KA} = 10\text{ mA}$ $\Delta V_{KA} = 10\text{ V} - V_{REF}$ | - | -1.0 | -2.7 | - | -1.0 | -2.7 | mV/V |
| | | $\Delta V_{KA} = 36\text{ V} - 10\text{ V}$ | - | -0.5 | -2.0 | - | -0.5 | -2.0 | |
| I_{REF} | Reference Input Current | $I_{KA} = 10\text{ mA}, R1 = 10\text{ k}\Omega, R2 = \infty$ | - | 1.5 | 4.0 | - | 1.5 | 4.0 | μA |
| $\Delta I_{REF}/\Delta T$ | Deviation of Reference Input Current Over Full Temperature Range | $I_{KA} = 10\text{ mA}, R1 = 10\text{ k}\Omega, R2 = \infty,$ $T_A = \text{Full Range}$ | - | 0.4 | 1.2 | - | 0.4 | 1.2 | μA |
| $I_{KA(MIN)}$ | Minimum Cathode Current for Regulation | $V_{KA} = V_{REF}$ | - | 0.45 | 1.00 | - | 0.45 | 1.00 | mA |
| $I_{KA(OFF)}$ | Off - Stage Cathode Current | $V_{KA} = 36\text{ V}, V_{REF} = 0$ | - | 0.05 | 1.00 | - | 0.05 | 1.00 | μA |
| Z_{KA} | Dynamic Impedance | $V_{KA} = V_{REF}, I_{KA} = 1\text{ to }100\text{ mA},$ $f \geq 1.0\text{ kHz}$ | - | 0.15 | 0.50 | - | 0.15 | 0.50 | Ω |

Product parametric performance is indicated in the Electrical Characteristics for the listed test conditions, unless otherwise noted. Product performance may not be indicated by the Electrical Characteristics if operated under different conditions.

1. $T_{MIN} = -25^\circ\text{C}, T_{MAX} = +85^\circ\text{C}.$

KA431A, KA431L

TEST CIRCUIT

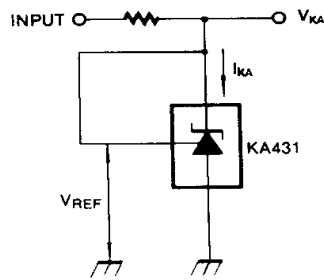

Figure 2. Test Circuit for $V_{KA} = V_{REF}$

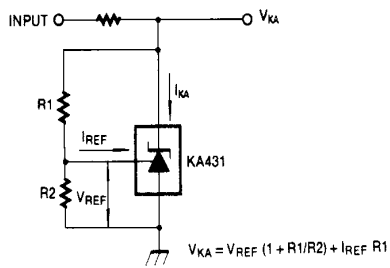

Figure 3. Test Circuit for $V_{KA} \geq V_{REF}$

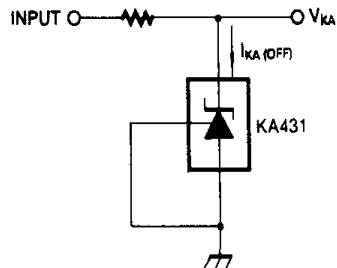

Figure 4. Test Circuit for $I_{KA(OFF)}$

KA431A, KA431L

TYPICAL PERFORMANCE CHARACTERISTICS



Figure 5. Cathode Current vs. Cathode Voltage



Figure 6. Cathode Current vs. Cathode Voltage



Figure 7. Change in Reference Input Voltage vs. Cathode Voltage



Figure 8. Dynamic Impedance Frequency

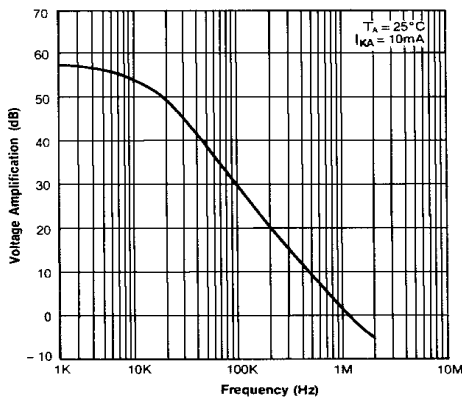

Figure 9. Small Signal Voltage Amplification vs. Frequency



Figure 10. Pulse Response

KA431A, KA431L

TYPICAL PERFORMANCE CHARACTERISTICS (Continued)

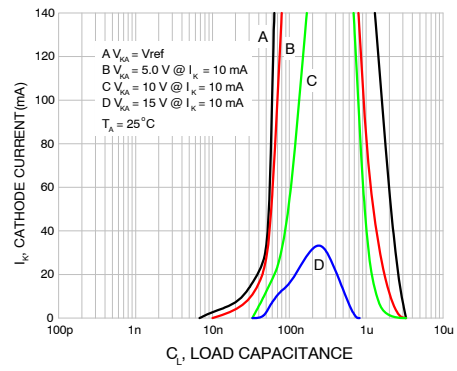

Figure 11. Stability Boundary Conditions

KA431A, KA431L

TYPICAL APPLICATION

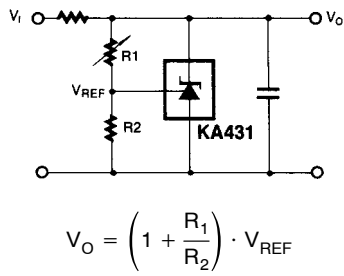

Figure 12. Shunt Regulator

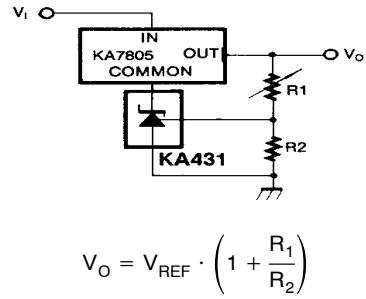

Figure 13. Output Control for Three-Terminal Fixed Regulator

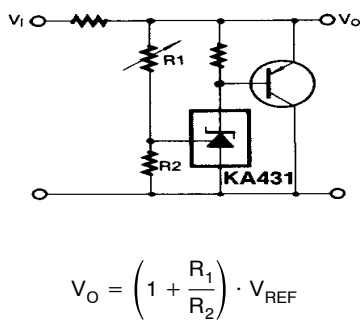

Figure 14. High-Current Shunt Regulator

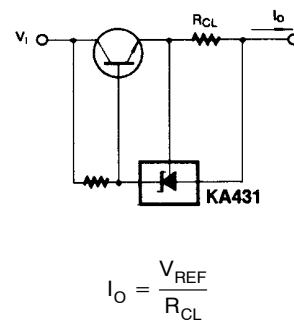

Figure 15. Current Limit or Current Source

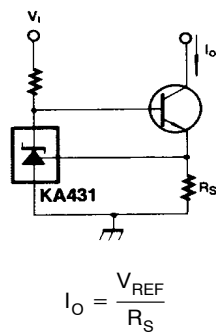

Figure 16. Constant-Current Sink

ORDERING INFORMATION

| Part Number | Operating Temperature Range | Output Voltage Tolerance | Tom Mark | Package | Packing Method |
|-------------|-----------------------------|--------------------------|----------|---------|----------------|
| KA431AZBU | -25 ~ +85°C | 1% | KA431AZ | TO-92 | Bulk |
| KA431AZTA | | | KA431AZ | TO-92 | Ammo |
| KA431LZTA | | 0.5% | KA431LZ | TO-92 | Ammo |

MECHANICAL CASE OUTLINE
PACKAGE DIMENSIONS

TO-92 3 4.825x4.76
CASE 135AN
ISSUE O

DATE 31 JUL 2016



NOTES: UNLESS OTHERWISE SPECIFIED

- A) DRAWING WITH REFERENCE TO JEDEC TO-92 RECOMMENDATIONS.
- B) ALL DIMENSIONS ARE IN MILLIMETERS.
- C) DRAWING CONFORMS TO ASME Y14.5M-2009.

| | | |
|-------------------------|---------------------------|--|
| DOCUMENT NUMBER: | 98AON13880G | Electronic versions are uncontrolled except when accessed directly from the Document Repository. Printed versions are uncontrolled except when stamped "CONTROLLED COPY" in red. |
| DESCRIPTION: | TO-92 3 4.825X4.76 | PAGE 1 OF 1 |

ON Semiconductor and **ON** are trademarks of Semiconductor Components Industries, LLC dba ON Semiconductor or its subsidiaries in the United States and/or other countries. ON Semiconductor reserves the right to make changes without further notice to any products herein. ON Semiconductor makes no warranty, representation or guarantee regarding the suitability of its products for any particular purpose, nor does ON Semiconductor assume any liability arising out of the application or use of any product or circuit, and specifically disclaims any and all liability, including without limitation special, consequential or incidental damages. ON Semiconductor does not convey any license under its patent rights nor the rights of others.

TO-92 3 4.83x4.76 LEADFORMED
CASE 135AR
ISSUE O

DATE 30 SEP 2016



NOTES: UNLESS OTHERWISE SPECIFIED

- A) DRAWING WITH REFERENCE TO JEDEC TO-92 RECOMMENDATIONS.
- B) ALL DIMENSIONS ARE IN MILLIMETERS.
- C) DRAWING CONFORMS TO ASME Y14.5M-1994

| | | |
|-------------------------|-------------------------------------|--|
| DOCUMENT NUMBER: | 98AON13879G | Electronic versions are uncontrolled except when accessed directly from the Document Repository. Printed versions are uncontrolled except when stamped "CONTROLLED COPY" in red. |
| DESCRIPTION: | TO-92 3 4.83X4.76 LEADFORMED | PAGE 1 OF 1 |

ON Semiconductor and  are trademarks of Semiconductor Components Industries, LLC dba ON Semiconductor or its subsidiaries in the United States and/or other countries. ON Semiconductor reserves the right to make changes without further notice to any products herein. ON Semiconductor makes no warranty, representation or guarantee regarding the suitability of its products for any particular purpose, nor does ON Semiconductor assume any liability arising out of the application or use of any product or circuit, and specifically disclaims any and all liability, including without limitation special, consequential or incidental damages. ON Semiconductor does not convey any license under its patent rights nor the rights of others.

onsemi, **Onsemi**, and other names, marks, and brands are registered and/or common law trademarks of Semiconductor Components Industries, LLC dba "**onsemi**" or its affiliates and/or subsidiaries in the United States and/or other countries. **onsemi** owns the rights to a number of patents, trademarks, copyrights, trade secrets, and other intellectual property. A listing of **onsemi**'s product/patent coverage may be accessed at www.onsemi.com/site/pdf/Patent-Marking.pdf. **onsemi** reserves the right to make changes at any time to any products or information herein, without notice. The information herein is provided "as-is" and **onsemi** makes no warranty, representation or guarantee regarding the accuracy of the information, product features, availability, functionality, or suitability of its products for any particular purpose, nor does **onsemi** assume any liability arising out of the application or use of any product or circuit, and specifically disclaims any and all liability, including without limitation special, consequential or incidental damages. Buyer is responsible for its products and applications using **onsemi** products, including compliance with all laws, regulations and safety requirements or standards, regardless of any support or applications information provided by **onsemi**. "Typical" parameters which may be provided in **onsemi** data sheets and/or specifications can and do vary in different applications and actual performance may vary over time. All operating parameters, including "Typicals" must be validated for each customer application by customer's technical experts. **onsemi** does not convey any license under any of its intellectual property rights nor the rights of others. **onsemi** products are not designed, intended, or authorized for use as a critical component in life support systems or any FDA Class 3 medical devices or medical devices with a same or similar classification in a foreign jurisdiction or any devices intended for implantation in the human body. Should Buyer purchase or use **onsemi** products for any such unintended or unauthorized application, Buyer shall indemnify and hold **onsemi** and its officers, employees, subsidiaries, affiliates, and distributors harmless against all claims, costs, damages, and expenses, and reasonable attorney fees arising out of, directly or indirectly, any claim of personal injury or death associated with such unintended or unauthorized use, even if such claim alleges that **onsemi** was negligent regarding the design or manufacture of the part. **onsemi** is an Equal Opportunity/Affirmative Action Employer. This literature is subject to all applicable copyright laws and is not for resale in any manner.

ADDITIONAL INFORMATION

TECHNICAL PUBLICATIONS:

Technical Library: www.onsemi.com/design/resources/technical-documentation
onsemi Website: www.onsemi.com

ONLINE SUPPORT: www.onsemi.com/support

For additional information, please contact your local Sales Representative at www.onsemi.com/support/sales

