

Optocoupler, Phototransistor Output, Dual Channel

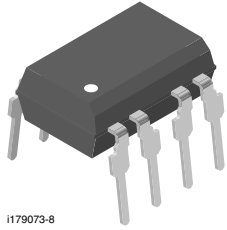

I179073-8

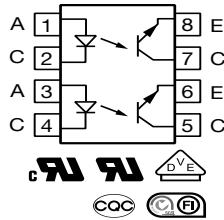

FEATURES

- Dual version of SFH610 series
- Isolation rated voltage 4420 V_{RMS}
- V_{CEsat} 0.25 (≤ 0.4) V at I_F = 10 mA, I_C = 2.5 mA
- V_{CEO} = 70 V
- Material categorization: for definitions of compliance please see www.vishay.com/doc?99912

RoHS
COMPLIANT

DESCRIPTION

The ILD610 series is a dual channel optocoupler series for high density applications. Each channel consists of an optically coupled pair with a gallium arsenide infrared LED and silicon NPN phototransistor. Signal information, including a DC level, can be transmitted by the device while maintaining a high degree of electrical isolation between input and output. The ILD610 series is the dual version of SFH610 series and uses a repetitive pin-out configuration instead of the more common alternating pin-out used in most dual couplers.

AGENCY APPROVALS

- [UL 1577](#)
- [cUL](#)
- [DIN EN 60747-5-5 \(VDE 0884\)](#), available with option 1
- [CQC](#)
- [FIMKO](#)

ORDERING INFORMATION		
<div style="display: flex; justify-content: space-around; align-items: center;"> <div style="border: 1px solid black; padding: 2px 5px;">I</div> <div style="border: 1px solid black; padding: 2px 5px;">L</div> <div style="border: 1px solid black; padding: 2px 5px;">D</div> <div style="border: 1px solid black; padding: 2px 5px;">6</div> <div style="border: 1px solid black; padding: 2px 5px;">1</div> <div style="border: 1px solid black; padding: 2px 5px;">0</div> <div style="border: 1px solid black; padding: 2px 5px;">-</div> <div style="border: 1px solid black; padding: 2px 5px;">#</div> </div> <p style="text-align: center; margin-top: 5px;">PART NUMBER CTR BIN</p>		
AGENCY CERTIFIED / PACKAGE		
UL, cUL, CQC, FIMKO	40 to 80	100 to 200
DIP-8	ILD610-1	ILD610-3

Note

- Additional options may be possible, please contact sales office

ABSOLUTE MAXIMUM RATINGS (T _{amb} = 25 °C, unless otherwise specified)				
PARAMETER	TEST CONDITION	SYMBOL	VALUE	UNIT
INPUT				
Reverse voltage		V _R	6.0	V
Surge forward current	t ≤ 1.0 ms	I _{FSM}	1.5	A
Power dissipation		P _{diss}	100	mW
Derate linearly from 25 °C			1.3	mW/°C
Forward continuous current		I _F	60	mA
OUTPUT				
Collector emitter voltage		V _{CEO}	70	V
Collector current		I _C	50	mA
	t ≤ 1.0 ms	I _C	100	mA
Power dissipation		P _{diss}	150	mW
Derate linearly from 25 °C			2.0	mW/°C
COUPLER				
Storage temperature		T _{stg}	-55 to +150	°C
Operating temperature		T _{amb}	-55 to +100	°C
Junction temperature		T _j	100	°C
Lead soldering time at 260 °C			10	s

Note

- Stresses in excess of the absolute maximum ratings can cause permanent damage to the device. Functional operation of the device is not implied at these or any other conditions in excess of those given in the operational sections of this document. Exposure to absolute maximum ratings for extended periods of the time can adversely affect reliability.



ELECTRICAL CHARACTERISTICS (T _{amb} = 25 °C, unless otherwise specified)							
PARAMETER	TEST CONDITION	PART	SYMBOL	MIN.	TYP.	MAX.	UNIT
INPUT							
Forward voltage	I _F = 60 mA		V _F	-	1.25	1.65	V
Reverse current	V _R = 6.0 V		I _R	-	0.01	10	μA
Capacitance	V _R = 0 V, f = 1.0 MHz		C _O	-	25	-	pF
OUTPUT							
Collector emitter breakdown voltage	I _C = 10 mA, I _E = 10 μA		BV _{CEO}	70	90	-	V
			BV _{CE0}	6.0	7.0	-	V
Collector emitter dark current	V _{CE} = 10 V		I _{CEO}	-	2.0	50	nA
Collector emitter capacitance	V _{CE} = 5.0 V, f = 1.0 MHz		C _{CE}	-	7.0	-	pF
Collector emitter leakage current	V _{CE} = 10 V	ILD610-1	I _{CEO}	-	2.0	50	nA
		ILD610-3	I _{CEO}	-	5.0	100	nA
COUPLER							
Collector emitter saturation voltage	I _F = 10 mA, I _C = 2.5 mA		V _{CEsat}	-	0.25	0.40	V
Coupling capacitance			C _C	-	0.35	-	pF

Note

- Minimum and maximum values are testing requirements. Typical values are characteristics of the device and are the result of engineering evaluation. Typical values are for information only and are not part of the testing requirements.

CURRENT TRANSFER RATIO (T _{amb} = 25 °C, unless otherwise specified)							
PARAMETER	TEST CONDITION	PART	SYMBOL	MIN.	TYP.	MAX.	UNIT
I _C /I _F ⁽¹⁾	I _F = 10 mA, V _{CE} = 5.0 V	ILD610-1	CTR	40	-	80	%
		ILD610-3	CTR	100	-	200	%
	I _F = 1.0 mA, V _{CE} = 5.0 V [^]	ILD610-1	CTR	13	-	-	%
		ILD610-3	CTR	34	-	-	%

Note

- ⁽¹⁾ CTR will match within a ratio of 1.7:1

SWITCHING CHARACTERISTICS (T _{amb} = 25 °C, unless otherwise specified)							
PARAMETER	TEST CONDITION	PART	SYMBOL	MIN.	TYP.	MAX.	UNIT
NON-SATURATED							
Rise time	V _{CC} = 5.0 V, R _L = 75 Ω, I _F = 10 mA	ILD610-1	t _r	-	2.0	-	μs
		ILD610-3			2.9		
Fall time	V _{CC} = 5.0 V, R _L = 75 Ω, I _F = 10 mA	ILD610-1	t _f	-	2.0	-	μs
		ILD610-3			3.1		
Turn-on time	V _{CC} = 5.0 V, R _L = 75 Ω, I _F = 10 mA	ILD610-1	t _{on}	-	3.0	-	μs
		ILD610-3			3.6		
Turn-off time	V _{CC} = 5.0 V, R _L = 75 Ω, I _F = 10 mA	ILD610-1	t _{off}	-	2.9	-	μs
		ILD610-3			3.7		
SATURATED							
Rise time	V _{CC} = 5.0 V, R _L = 1.0 kΩ, I _F = 20 mA	ILD610-1	t _r	-	2.0	-	μs
	V _{CC} = 5.0 V, R _L = 1.0 kΩ, I _F = 10 mA	ILD610-3			2.8		
Fall time	V _{CC} = 5.0 V, R _L = 1.0 kΩ, I _F = 20 mA	ILD610-1	t _f	-	11	-	μs
	V _{CC} = 5.0 V, R _L = 1.0 kΩ, I _F = 10 mA	ILD610-3			14		
Turn-on time	V _{CC} = 5.0 V, R _L = 1.0 kΩ, I _F = 20 mA	ILD610-1	t _{on}	-	3.0	-	μs
	V _{CC} = 5.0 V, R _L = 1.0 kΩ, I _F = 10 mA	ILD610-3			4.3		
Turn-off time	V _{CC} = 5.0 V, R _L = 1.0 kΩ, I _F = 20 mA	ILD610-1	t _{off}	-	18	-	μs
	V _{CC} = 5.0 V, R _L = 1.0 kΩ, I _F = 10 mA	ILD610-3			25		

SAFETY AND INSULATION RATINGS				
PARAMETER	TEST CONDITION	SYMBOL	VALUE	UNIT
Climatic classification	According to IEC 68 part 1		55 / 100 / 21	
Comparative tracking index		CTI	175	
Maximum rated withstanding isolation voltage	t = 1 min	V_{ISO}	4420	V_{RMS}
Maximum transient isolation voltage		V_{IOTM}	10 000	V_{peak}
Maximum repetitive peak isolation voltage		V_{IORM}	890	V_{peak}
Isolation resistance	$V_{IO} = 500\text{ V}, T_{amb} = 25\text{ }^{\circ}\text{C}$	R_{IO}	$\geq 10^{12}$	Ω
	$V_{IO} = 500\text{ V}, T_{amb} = 100\text{ }^{\circ}\text{C}$	R_{IO}	$\geq 10^{11}$	Ω
Output safety power		P_{SO}	400	mW
Input safety current		I_{SI}	275	mA
Safety temperature		T_S	175	$^{\circ}\text{C}$
Creepage distance			≥ 7	mm
Clearance distance			≥ 7	mm
Insulation thickness		DTI	≥ 0.4	mm

Note

- As per IEC 60747-5-5, § 7.4.3.8.2, this optocoupler is suitable for “safe electrical insulation” only within the safety ratings. Compliance with the safety ratings shall be ensured by means of protective circuits.

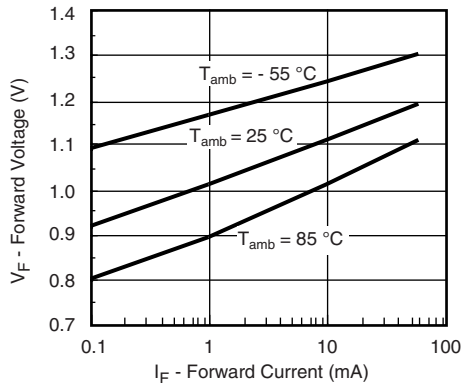
TYPICAL CHARACTERISTICS ($T_{amb} = 25\text{ }^{\circ}\text{C}$, unless otherwise specified)

iilct6_01

Fig. 1 - Forward Voltage vs. Forward Current

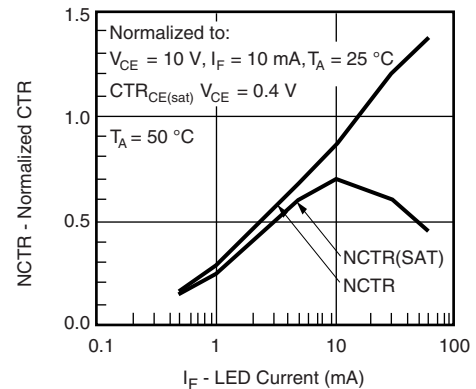

iilct6_03

Fig. 3 - Normalized Non-Saturated and Saturated CTR vs. LED Current

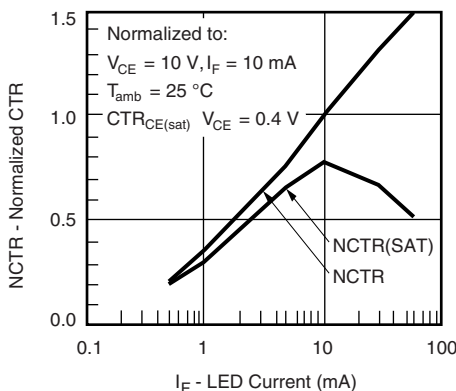

iilct6_02

Fig. 2 - Normalized Non-Saturated and Saturated CTR vs. LED Current

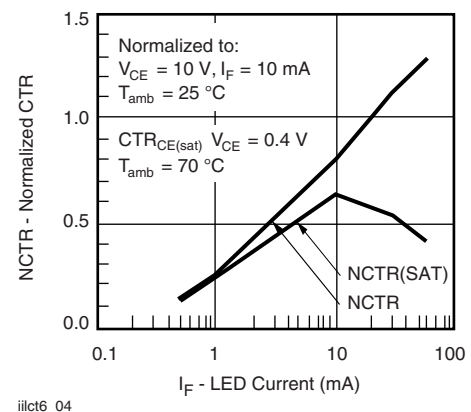

iilct6_04

Fig. 4 - Normalized Non-Saturated and Saturated CTR vs. LED Current

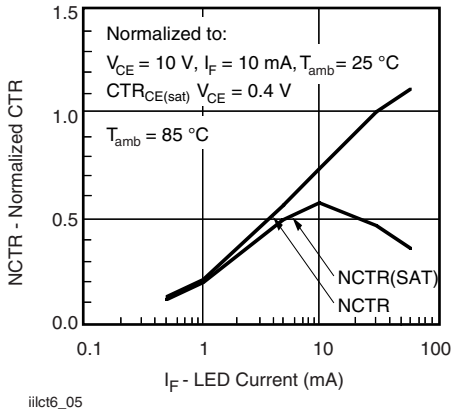

Fig. 5 - Normalized Non-Saturated and Saturated CTR vs. LED Current

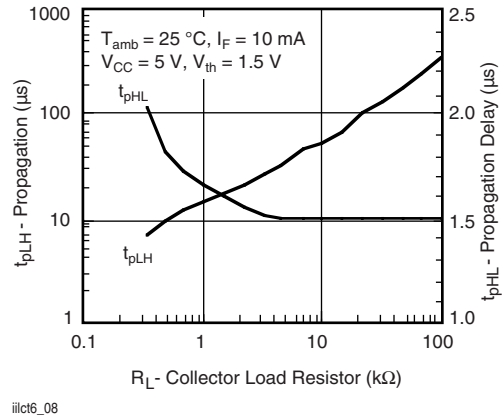

Fig. 8 - Propagation Delay vs. Collector Load Resistor

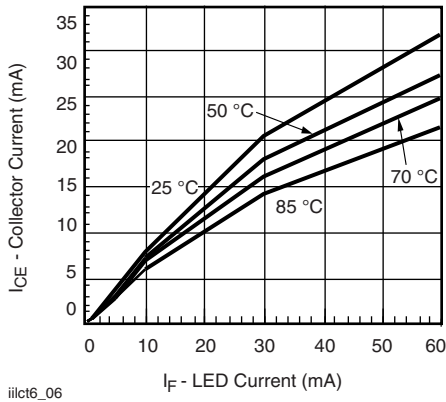

Fig. 6 - Collector Emitter Current vs. Temperature and LED Current

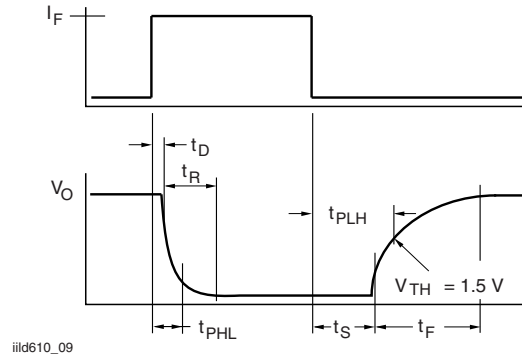

Fig. 9 - Switching Timing

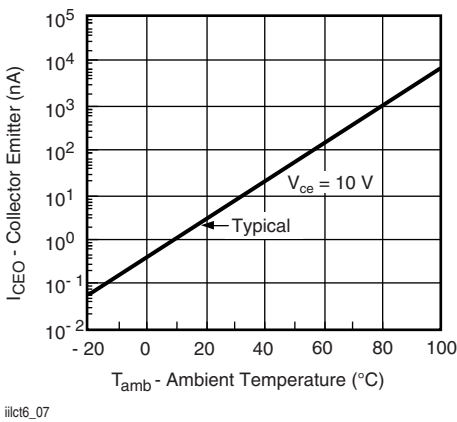

Fig. 7 - Collector Emitter Leakage Current vs. Temperature

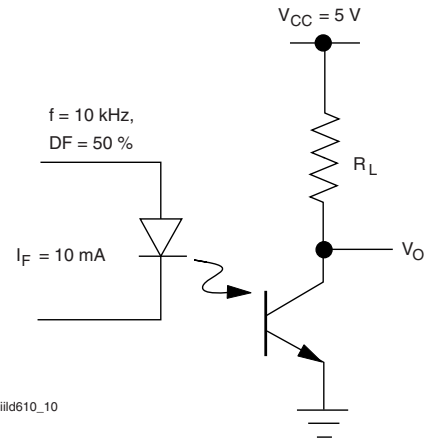
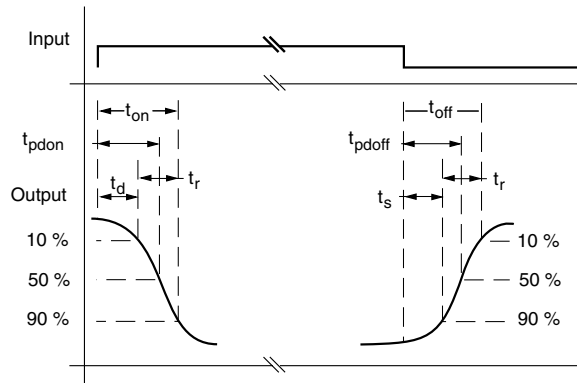

Fig. 10 - Non-Saturated Switching Schematic



ild610_11

Fig. 11 - Saturated Switching Time Test Waveform

PACKAGE DIMENSIONS in millimeters

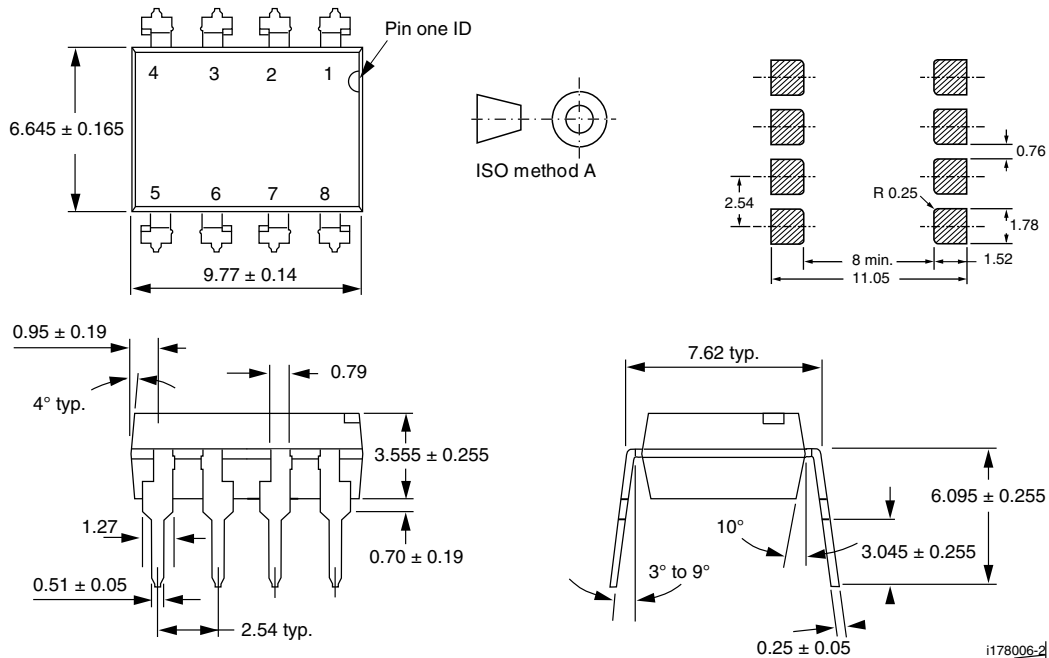

PACKAGE MARKING

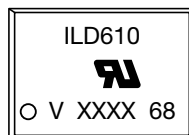

Notes

- XXXX = LMC (lot marking code)
- Option 1 is reflected in the package marking
- Tape and reel suffix (T) is not part of the package marking



Disclaimer

ALL PRODUCT, PRODUCT SPECIFICATIONS AND DATA ARE SUBJECT TO CHANGE WITHOUT NOTICE TO IMPROVE RELIABILITY, FUNCTION OR DESIGN OR OTHERWISE.

Vishay Intertechnology, Inc., its affiliates, agents, and employees, and all persons acting on its or their behalf (collectively, "Vishay"), disclaim any and all liability for any errors, inaccuracies or incompleteness contained in any datasheet or in any other disclosure relating to any product.

Vishay makes no warranty, representation or guarantee regarding the suitability of the products for any particular purpose or the continuing production of any product. To the maximum extent permitted by applicable law, Vishay disclaims (i) any and all liability arising out of the application or use of any product, (ii) any and all liability, including without limitation special, consequential or incidental damages, and (iii) any and all implied warranties, including warranties of fitness for particular purpose, non-infringement and merchantability.

Statements regarding the suitability of products for certain types of applications are based on Vishay's knowledge of typical requirements that are often placed on Vishay products in generic applications. Such statements are not binding statements about the suitability of products for a particular application. It is the customer's responsibility to validate that a particular product with the properties described in the product specification is suitable for use in a particular application. Parameters provided in datasheets and / or specifications may vary in different applications and performance may vary over time. All operating parameters, including typical parameters, must be validated for each customer application by the customer's technical experts. Product specifications do not expand or otherwise modify Vishay's terms and conditions of purchase, including but not limited to the warranty expressed therein.

Hyperlinks included in this datasheet may direct users to third-party websites. These links are provided as a convenience and for informational purposes only. Inclusion of these hyperlinks does not constitute an endorsement or an approval by Vishay of any of the products, services or opinions of the corporation, organization or individual associated with the third-party website. Vishay disclaims any and all liability and bears no responsibility for the accuracy, legality or content of the third-party website or for that of subsequent links.

Except as expressly indicated in writing, Vishay products are not designed for use in medical, life-saving, or life-sustaining applications or for any other application in which the failure of the Vishay product could result in personal injury or death. Customers using or selling Vishay products not expressly indicated for use in such applications do so at their own risk. Please contact authorized Vishay personnel to obtain written terms and conditions regarding products designed for such applications.

No license, express or implied, by estoppel or otherwise, to any intellectual property rights is granted by this document or by any conduct of Vishay. Product names and markings noted herein may be trademarks of their respective owners.