

6-Pin DIP Zero-Cross Triac Driver Optocoupler (600 Volt Peak)

MOC3061M, MOC3062M, MOC3063M, MOC3162M, MOC3163M

Description

The MOC306XM and MOC316XM devices consist of a GaAs infrared emitting diode optically coupled to a monolithic silicon detector performing the function of a zero voltage crossing bilateral triac driver.

They are designed for use with a triac in the interface of logic systems to equipment powered from 115/240 VAC lines, such as solid-state relays, industrial controls, motors, solenoids and consumer appliances, etc.

Features

- Simplifies Logic Control of 115/240 VAC Power
- Zero Voltage Crossing to Minimize Conducted and Radiated Line Noise
- 600 V Peak Blocking Voltage
- Superior Static dv/dt
 - ◆ 600 V/μs (MOC306xM)
 - ◆ 1000 V/μs (MOC316xM)
- Safety and Regulatory Approvals
 - ◆ UL1577, 4,170 VAC_{RMS} for 1 Minute
 - ◆ DIN EN/IEC60747-5-5
- These are Pb-Free Devices

Applications

- Solenoid/Valve Controls
- Static Power Switches
- Temperature Controls
- AC Motor Starters
- Lighting Controls
- AC Motor Drives
- E.M. Contactors
- Solid State Relays

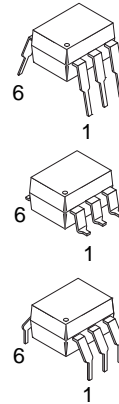

PDIP6 8.51x6.35, 2.54P
CASE 646BX

PDIP6 8.51x6.35, 2.54P
CASE 646BY

PDIP6 8.51x6.35, 2.54P
CASE 646BZ

MARKING DIAGRAM

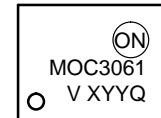

- MOC3061 = Device Number
- V = DIN EN/IEC60747-5-5 Option (only appears on component ordered with this option)
- X = One-Digit Year Code, e.g., '5'
- YY = Two-Digit Work Week, Ranging from '01' to '53'
- Q = Assembly Package Code

SCHEMATIC

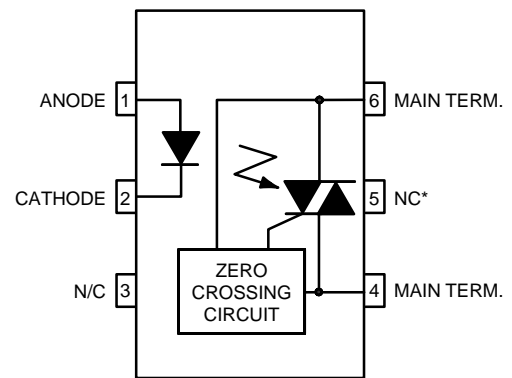

*DO NOT CONNECT (TRIAC SUBSTRATE)

ORDERING INFORMATION

See detailed ordering and shipping information on page 8 of this data sheet.

MOC3061M, MOC3062M, MOC3063M, MOC3162M, MOC3163M

SAFETY AND INSULATION RATINGS (As per DIN EN/IEC 60747-5-5, this optocoupler is suitable for “safe electrical insulation” only within the safety limit data. Compliance with the safety ratings shall be ensured by means of protective circuits.)

| Parameter | | Characteristics |
|-------------------------------------------------------------------------------------|-----------------------|-----------------|
| Installation Classifications per DIN VDE 0110/1.89 Table 1, For Rated Mains Voltage | <150 V _{RMS} | I-IV |
| | <300 V _{RMS} | I-IV |
| Climatic Classification | | 40/85/21 |
| Pollution Degree (DIN VDE 0110/1.89) | | 2 |
| Comparative Tracking Index | | 175 |

| Symbol | Parameter | Value | Unit |
|-------------------|----------------------------------------------------------------------------------------------------------------------------------------------------------------|------------------|-------------------|
| V _{PR} | Input-to-Output Test Voltage, Method A, V _{IORM} × 1.6 = V _{PR} , Type and Sample Test with t _m = 10 s, Partial Discharge < 5 pC | 1360 | V _{peak} |
| | Input-to-Output Test Voltage, Method B, V _{IORM} × 1.875 = V _{PR} , 100% Production Test with t _m = 1 s, Partial Discharge < 5 pC | 1594 | V _{peak} |
| V _{IORM} | Maximum Working Insulation Voltage | 850 | V _{peak} |
| V _{IOTM} | Highest Allowable Over-Voltage | 6000 | V _{peak} |
| | External Creepage | ≥7 | mm |
| | External Clearance | ≥7 | mm |
| | External Clearance (for Option TV, 0.4" Lead Spacing) | ≥10 | mm |
| DTI | Distance Through Insulation (Insulation Thickness) | ≥0.5 | mm |
| R _{IO} | Insulation Resistance at T _S , V _{IO} = 500 V | >10 ⁹ | Ω |

ABSOLUTE MAXIMUM RATINGS (T_A = 25°C unless otherwise noted)

| Symbol | Parameter | Device | Value | Unit |
|--------|-----------|--------|-------|------|
|--------|-----------|--------|-------|------|

TOTAL DEVICE

| | | | | |
|------------------|------------------------------------------------|-----|--------------------|-------|
| T _{STG} | Storage Temperature | All | -40 to +125 | °C |
| T _{OPR} | Operating Temperature | All | -40 to +85 | °C |
| T _J | Junction Temperature Range | All | -40 to +100 | °C |
| T _{SOL} | Lead Solder Temperature | All | 260 for 10 seconds | °C |
| P _D | Total Device Power Dissipation at 25°C Ambient | All | 250 | mW |
| | Derate Above 25°C | | 2.94 | mW/°C |

EMITTER

| | | | | |
|----------------|-----------------------------------------|-----|------|-------|
| I _F | Continuous Forward Current | All | 60 | mA |
| V _R | Reverse Voltage | All | 6 | V |
| P _D | Total Power Dissipation at 25°C Ambient | All | 120 | mW |
| | Derate Above 25°C | | 1.41 | mW/°C |

DETECTOR

| | | | | |
|------------------|------------------------------------------------------------------|-----|------|--------------------|
| V _{DRM} | Off-State Output Terminal Voltage | All | 600 | V |
| I _{TSM} | Peak Non-Repetitive Surge Current (Single Cycle 60 Hz Sine Wave) | All | 1 | A _{peak} |
| I _{TM} | Peak Repetitive On-State Current | All | 100 | mA _{peak} |
| P _D | Total Power Dissipation at 25°C Ambient | All | 150 | mW |
| | Derate Above 25°C | | 1.76 | mW/°C |

Stresses exceeding those listed in the Maximum Ratings table may damage the device. If any of these limits are exceeded, device functionality should not be assumed, damage may occur and reliability may be affected.

MOC3061M, MOC3062M, MOC3063M, MOC3162M, MOC3163M

ELECTRICAL CHARACTERISTICS (T_A = 25°C, unless otherwise noted)

| Symbol | Parameter | Test Conditions | Device | Min | Typ | Max | Unit |
|--------|-----------|-----------------|--------|-----|-----|-----|------|
|--------|-----------|-----------------|--------|-----|-----|-----|------|

INDIVIDUAL COMPONENT CHARACTERISTICS

| EMITTER | | | | | | | |
|-------------------|--------------------------------------------|-------------------------------------------------------|----------|------|-------|-----|------|
| V _F | Input Forward Voltage | I _F = 30 mA | All | – | 1.3 | 1.5 | V |
| I _R | Reverse Leakage Current | V _R = 6 V | All | – | 0.005 | 100 | μA |
| DETECTOR | | | | | | | |
| I _{DRM1} | Peak Blocking Current, Either Direction | V _{DRM} = 600 V, I _F = 0 (Note 1) | MOC306XM | – | 10 | 500 | nA |
| | | | MOC316XM | – | 10 | 100 | |
| dv/dt | Critical Rate of Rise of Off-State Voltage | I _F = 0 (Note 2) | MOC306XM | 600 | 1500 | – | V/μs |
| | | | MOC316XM | 1000 | – | – | |

TRANSFER CHARACTERISTICS

| | | | | | | | |
|-----------------|----------------------------------------------|-----------------------------------------------------------------------|----------------------|---|-----|-----|----|
| I _{FT} | LED Trigger Current (Rated I _{FT}) | Main Terminal Voltage = 3 V (Note 3) | MOC3061M | – | – | 15 | mA |
| | | | MOC3062M MOC3162M | – | – | 10 | |
| | | | MOC3063M MOC3163M | – | – | 5 | |
| V _{TM} | Peak On-State Voltage, Either Direction | I _{TM} = 100 mA peak, I _F = rated I _{FT} | All | – | 1.8 | 3.0 | V |
| I _H | Holding Current, Either Direction | | All | – | 500 | – | μA |

ZERO CROSSING CHARACTERISTICS

| | | | | | | | |
|-------------------|-----------------------------------------------------------------------|------------------------------------------------------------------------------|----------------------------------|---|----|----|----|
| V _{INH} | Inhibit Voltage (MT1–MT2 Voltage Above Which Device will not Trigger) | I _F = rated I _{FT} | MOC3061M MOC3062M MOC3063M | – | 12 | 20 | V |
| | | | MOC3162M MOC3163M | – | 12 | 15 | |
| I _{DRM2} | Leakage in Inhibited State | I _F = rated I _{FT} , V _{DRM} = 600 V, off-state | All | – | – | 2 | mA |

ISOLATION CHARACTERISTICS

| | | | | | | | |
|------------------|----------------------------|----------------------------------------|--|------|------------------|---|--------------------|
| V _{ISO} | Isolation Voltage (Note 4) | f = 60 Hz, t = 1 Minute | | 4170 | – | – | V _{ACRMS} |
| R _{ISO} | Isolation Resistance | V _{I-O} = 500 V _{DC} | | – | 10 ¹¹ | – | Ω |
| C _{ISO} | Isolation Capacitance | V = 0 V, f = 1 MHz | | – | 0.2 | – | pF |

Product parametric performance is indicated in the Electrical Characteristics for the listed test conditions, unless otherwise noted. Product performance may not be indicated by the Electrical Characteristics if operated under different conditions.

1. Test voltage must be applied within dv/dt rating.
2. This is static dv/dt. Commutating dv/dt is a function of the load-driving thyristor(s) only.
3. All devices are guaranteed to trigger at an I_F value less than or equal to max I_{FT}. Therefore, recommended operating I_F lies between max I_{FT} (15 mA for MOC3061M, 10 mA for MOC3062M and MOC3162M, 5 mA for MOC3063M and MOC3163M) and absolute maximum I_F (60 mA).
4. Isolation voltage, V_{ISO}, is an internal device dielectric breakdown rating. For this test, pins 1 and 2 are common, and pins 4, 5 and 6 are common.

TYPICAL PERFORMANCE CURVES

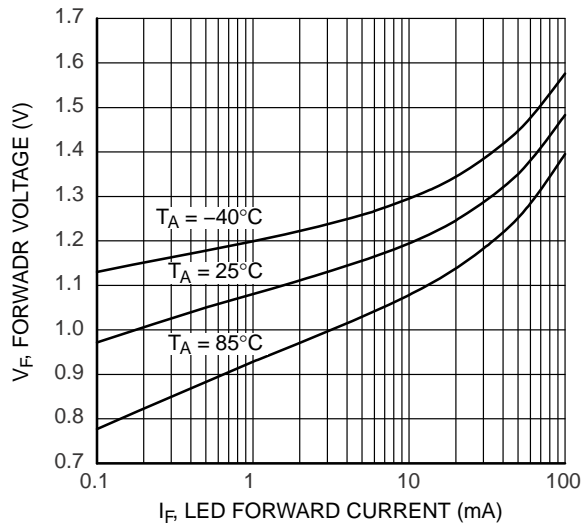

Figure 1. LED Forward Voltage vs. Forward Current

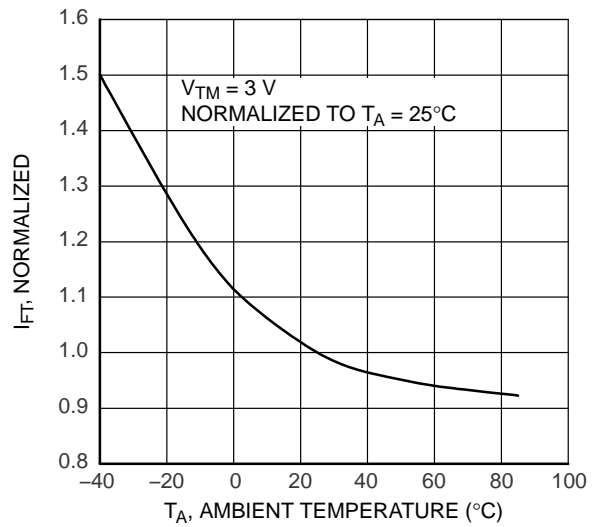

Figure 2. Trigger Current Vs. Temperature

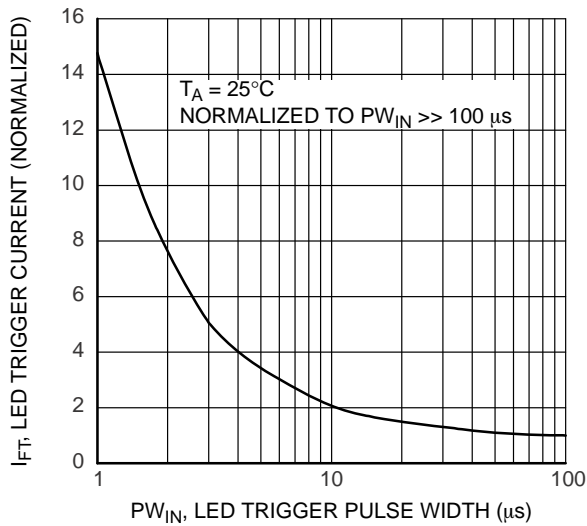

Figure 3. LED Current Required to Trigger vs. LED Pulse Width

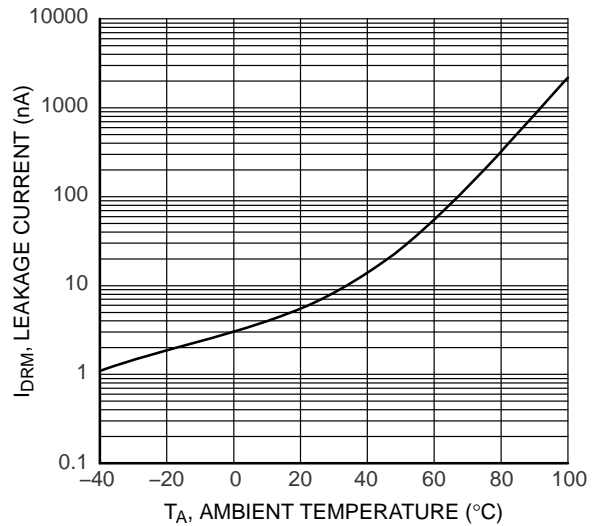

Figure 4. Leakage Current, I_{DRM} vs. Temperature

TYPICAL PERFORMANCE CURVES (Continued)

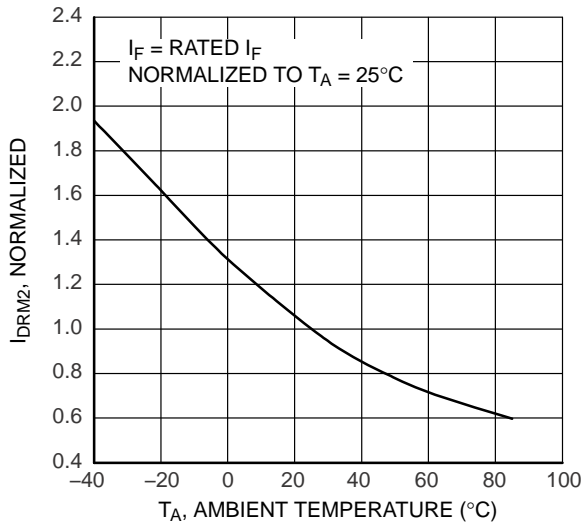

Figure 5. I_{DRM2}, Leakage in Inhibit State vs. Temperature

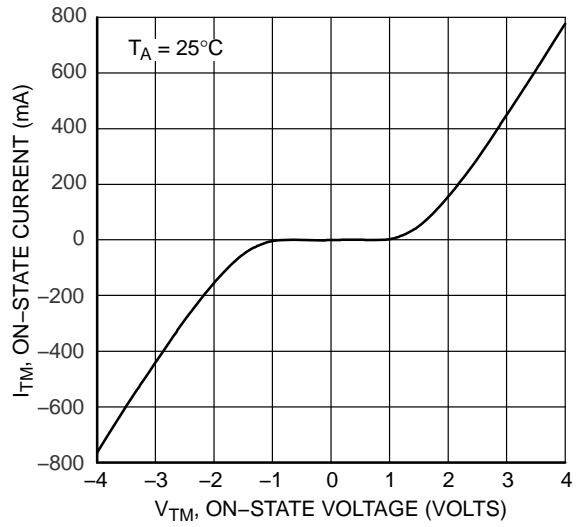

Figure 6. On-State Characteristics

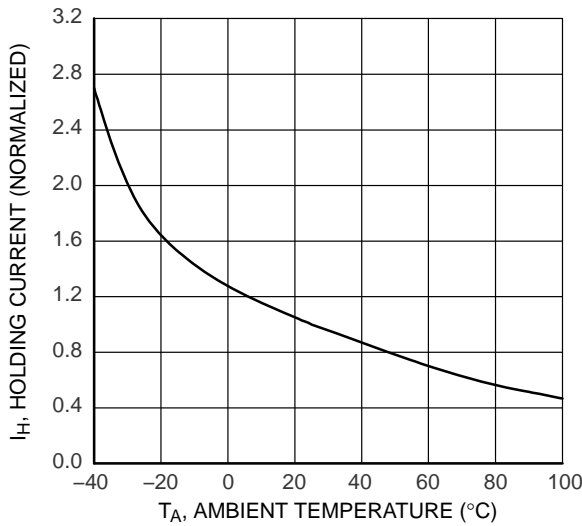

Figure 7. I_H, Holding Current vs. Temperature

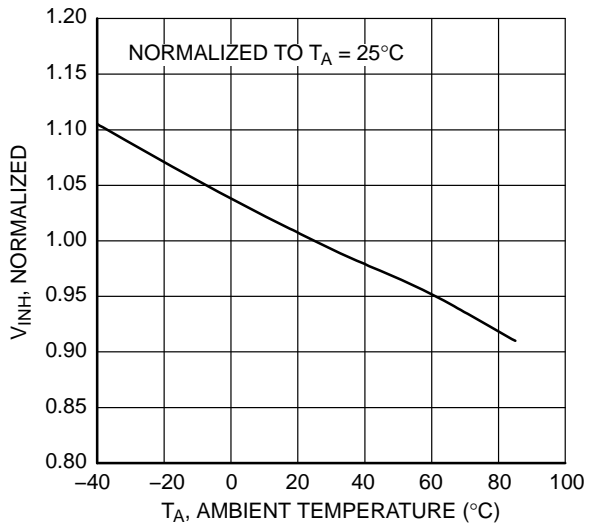

Figure 8. Inhibit Voltage vs. Temperature

MOC3061M, MOC3062M, MOC3063M, MOC3162M, MOC3163M

APPLICATION INFORMATION

Basic Applications

Typical circuit for use when hot line switching is required. In this circuit the “hot” side of the line is switched and the load connected to the cold or neutral side. The load may be connected to either the neutral or hot line.

R_{in} is calculated so that I_F is equal to the rated I_{FT} of the part, 15 mA for the MOC3061M, 10 mA for the MOC3062M, or 5 mA for the MOC3063M.

The $39\ \Omega$ resistor and $0.01\ \mu\text{F}$ capacitor are for snubbing of the triac and is often, but not always, necessary depending upon the particular triac and load used.

Suggested method of firing two, back-to-back SCR's with a **onsemi** triac driver. Diodes can be 1N4001; resistors, R1 and R2, are optional $330\ \Omega$.

NOTE: This optoisolator should not be used to drive a load directly. It is intended to be a trigger device only.

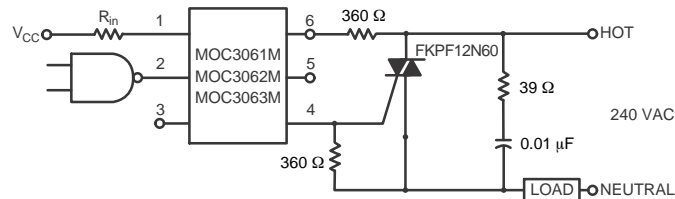

Figure 9. Hot-Line Switching Application Circuit

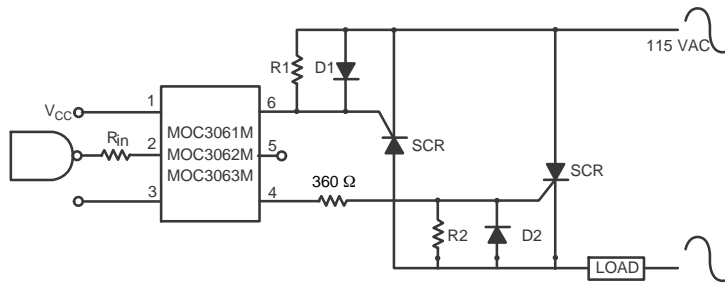
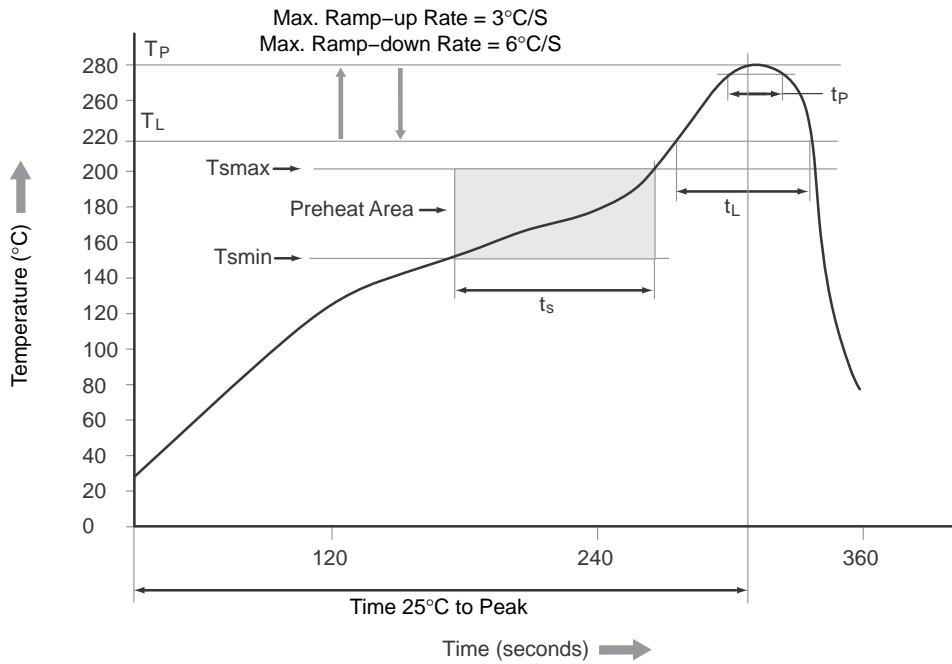

Figure 10. Inverse-Parallel SCR Driver Circuit

MOC3061M, MOC3062M, MOC3063M, MOC3162M, MOC3163M



| | |
|-----------------------------------------------------------------------|---------------------------|
| Temperature Minimum (T _{smin}) | 150°C |
| Temperature Maximum (T _{smax}) | 200°C |
| Time (t _s) from (T _{smin} to T _{smax}) | 60 seconds to 120 seconds |
| Ramp-up Rate (T _L to T _P) | 3°C/second maximum |
| Liquidous Temperature (T _L) | 217°C |
| Time (t _L) Maintained Above (T _L) | 60 seconds to 150 seconds |
| Peak Body Package Temperature | 260°C +0°C / -5°C |
| Time (t _p) within 5°C of 260°C | 30 seconds |
| Ramp-down Rate (T _P to T _L) | 6°C/second maximum |
| Time 25°C to Peak Temperature | 8 minutes maximum |

Figure 11. Reflow Profile

MOC3061M, MOC3062M, MOC3063M, MOC3162M, MOC3163M

ORDERING INFORMATION (Note 5)

| Part Number | Package | Shipping [†] |
|--------------|-----------------------------------------------------------------------|-----------------------|
| MOC3061M | DIP 6-Pin (Pb-Free) | 50 Units / Tube |
| MOC3061SM | SMT 6-Pin (Lead Bend) (Pb-Free) | 50 Units / Tube |
| MOC3061SR2M | SMT 6-Pin (Lead Bend) (Pb-Free) | 1000 / Tape & Reel |
| MOC3061VM | DIP 6-Pin, DIN EN/IEC60747-5-5 Option (Pb-Free) | 50 Units / Tube |
| MOC3061SVM | SMT 6-Pin (Lead Bend), DIN EN/IEC60747-5-5 Option (Pb-Free) | 50 Units / Tube |
| MOC3061SR2VM | SMT 6-Pin (Lead Bend), DIN EN/IEC60747-5-5 Option (Pb-Free) | 1000 / Tape & Reel |
| MOC3061TVM | DIP 6-Pin, 0.4" Lead Spacing, DIN EN/IEC60747-5-5 Option (Pb-Free) | 50 Units / Tube |

[†]For information on tape and reel specifications, including part orientation and tape sizes, please refer to our Tape and Reel Packaging Specifications Brochure, BRD8011/D.

5. The product orderable part number system listed in this table also applies to the MOC3062M, MOC3063M, MOC3162M, and MOC3163M product families.

MECHANICAL CASE OUTLINE

PACKAGE DIMENSIONS

ON Semiconductor®



PDIP6 8.51x6.35, 2.54P
CASE 646BX
ISSUE O

DATE 31 JUL 2016

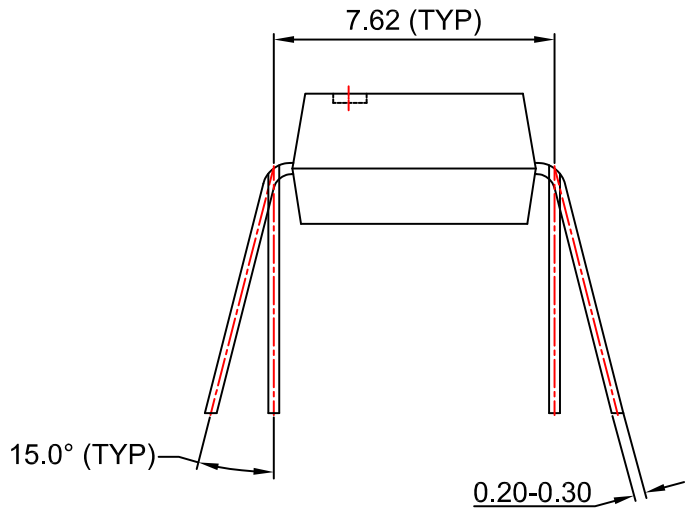

NOTES:

- A) NO STANDARD APPLIES TO THIS PACKAGE.
- B) ALL DIMENSIONS ARE IN MILLIMETERS.
- C) DIMENSIONS ARE EXCLUSIVE OF BURRS, MOLD FLASH, AND TIE BAR EXTRUSION

| | | |
|-------------------------|-------------------------------|----------------------------------------------------------------------------------------------------------------------------------------------------------------------------------|
| DOCUMENT NUMBER: | 98AON13449G | Electronic versions are uncontrolled except when accessed directly from the Document Repository. Printed versions are uncontrolled except when stamped "CONTROLLED COPY" in red. |
| DESCRIPTION: | PDIP6 8.51X6.35, 2.54P | PAGE 1 OF 1 |

ON Semiconductor and are trademarks of Semiconductor Components Industries, LLC dba ON Semiconductor or its subsidiaries in the United States and/or other countries. ON Semiconductor reserves the right to make changes without further notice to any products herein. ON Semiconductor makes no warranty, representation or guarantee regarding the suitability of its products for any particular purpose, nor does ON Semiconductor assume any liability arising out of the application or use of any product or circuit, and specifically disclaims any and all liability, including without limitation special, consequential or incidental damages. ON Semiconductor does not convey any license under its patent rights nor the rights of others.

MECHANICAL CASE OUTLINE

PACKAGE DIMENSIONS

ON Semiconductor®



PDIP6 8.51x6.35, 2.54P

CASE 646BY

ISSUE A

DATE 15 JUL 2019



NOTES:

1. DIMENSIONING AND TOLERANCING PER ASME Y14.5M, 2009.
2. CONTROLLING DIMENSION: MILLIMETERS
3. DIMENSIONS A, A1, AND L ARE MEASURED WITH THE PACKAGE SEATED.
4. DIMENSIONS D, D1, AND E1 DO NOT INCLUDE MOLD FLASH OR PROTRUSIONS. MOLD FLASH OR PROTRUSIONS ARE NOT TO EXCEED 2.54mm.
5. PACKAGE CONTOUR IS OPTIONAL (ROUNDED OR SQUARE CORNERS).
6. CENTER LINE OF CORNER LEADS ARE LOCATED BY LOCATING THE CENTER OF FEATURE b2 AND b3.

| DIM | MILLIMETERS | | |
|-----|-------------|------|------|
| | MIN. | NOM. | MAX. |
| A | --- | --- | 4.80 |
| A1 | 0.38 | --- | --- |
| A2 | 3.28 | 3.40 | 3.53 |
| A3 | 2.49 REF | | |
| A4 | 1.89 REF | | |
| b | 0.41 | 0.46 | 0.51 |
| b1 | 0.76 | 0.92 | 1.14 |
| b2 | 0.25 | 0.28 | 0.36 |
| b3 | 1.02 | 1.40 | 1.78 |
| b4 | 1.778 REF | | |
| c | 0.20 | 0.25 | 0.30 |
| D | 8.13 | 8.51 | 8.89 |
| D1 | 0.86 REF | | |
| E | 6.10 | 6.35 | 6.60 |
| E1 | 8.43 | 9.17 | 9.90 |
| E2 | 8.13 REF | | |
| e | 2.54 BSC | | |
| L | 0.16 | 0.52 | 0.88 |

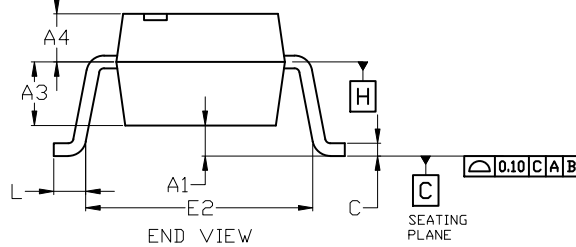

For additional information on our Pb-Free strategy and soldering details, please download the ON Semiconductor Soldering and Mounting Techniques Reference Manual, SOLDERM/D.

| | | |
|-------------------------|-------------------------------|----------------------------------------------------------------------------------------------------------------------------------------------------------------------------------|
| DOCUMENT NUMBER: | 98AON13450G | Electronic versions are uncontrolled except when accessed directly from the Document Repository. Printed versions are uncontrolled except when stamped "CONTROLLED COPY" in red. |
| DESCRIPTION: | PDIP6 8.51x6.35, 2.54P | PAGE 1 OF 1 |

ON Semiconductor and ON are trademarks of Semiconductor Components Industries, LLC dba ON Semiconductor or its subsidiaries in the United States and/or other countries. ON Semiconductor reserves the right to make changes without further notice to any products herein. ON Semiconductor makes no warranty, representation or guarantee regarding the suitability of its products for any particular purpose, nor does ON Semiconductor assume any liability arising out of the application or use of any product or circuit, and specifically disclaims any and all liability, including without limitation special, consequential or incidental damages. ON Semiconductor does not convey any license under its patent rights nor the rights of others.

MECHANICAL CASE OUTLINE
PACKAGE DIMENSIONS

PDIP6 8.51x6.35, 2.54P
CASE 646BZ
ISSUE O

DATE 31 JUL 2016



NOTES:

- A) NO STANDARD APPLIES TO THIS PACKAGE.
- B) ALL DIMENSIONS ARE IN MILLIMETERS.
- C) DIMENSIONS ARE EXCLUSIVE OF BURRS, MOLD FLASH, AND TIE BAR EXTRUSION

| | | |
|-------------------------|-------------------------------|----------------------------------------------------------------------------------------------------------------------------------------------------------------------------------|
| DOCUMENT NUMBER: | 98AON13451G | Electronic versions are uncontrolled except when accessed directly from the Document Repository. Printed versions are uncontrolled except when stamped "CONTROLLED COPY" in red. |
| DESCRIPTION: | PDIP6 8.51X6.35, 2.54P | PAGE 1 OF 1 |

ON Semiconductor and **ON** are trademarks of Semiconductor Components Industries, LLC dba ON Semiconductor or its subsidiaries in the United States and/or other countries. ON Semiconductor reserves the right to make changes without further notice to any products herein. ON Semiconductor makes no warranty, representation or guarantee regarding the suitability of its products for any particular purpose, nor does ON Semiconductor assume any liability arising out of the application or use of any product or circuit, and specifically disclaims any and all liability, including without limitation special, consequential or incidental damages. ON Semiconductor does not convey any license under its patent rights nor the rights of others.

onsemi, **Onsemi**, and other names, marks, and brands are registered and/or common law trademarks of Semiconductor Components Industries, LLC dba "**onsemi**" or its affiliates and/or subsidiaries in the United States and/or other countries. **onsemi** owns the rights to a number of patents, trademarks, copyrights, trade secrets, and other intellectual property. A listing of **onsemi**'s product/patent coverage may be accessed at www.onsemi.com/site/pdf/Patent-Marking.pdf. **onsemi** reserves the right to make changes at any time to any products or information herein, without notice. The information herein is provided "as-is" and **onsemi** makes no warranty, representation or guarantee regarding the accuracy of the information, product features, availability, functionality, or suitability of its products for any particular purpose, nor does **onsemi** assume any liability arising out of the application or use of any product or circuit, and specifically disclaims any and all liability, including without limitation special, consequential or incidental damages. Buyer is responsible for its products and applications using **onsemi** products, including compliance with all laws, regulations and safety requirements or standards, regardless of any support or applications information provided by **onsemi**. "Typical" parameters which may be provided in **onsemi** data sheets and/or specifications can and do vary in different applications and actual performance may vary over time. All operating parameters, including "Typicals" must be validated for each customer application by customer's technical experts. **onsemi** does not convey any license under any of its intellectual property rights nor the rights of others. **onsemi** products are not designed, intended, or authorized for use as a critical component in life support systems or any FDA Class 3 medical devices or medical devices with a same or similar classification in a foreign jurisdiction or any devices intended for implantation in the human body. Should Buyer purchase or use **onsemi** products for any such unintended or unauthorized application, Buyer shall indemnify and hold **onsemi** and its officers, employees, subsidiaries, affiliates, and distributors harmless against all claims, costs, damages, and expenses, and reasonable attorney fees arising out of, directly or indirectly, any claim of personal injury or death associated with such unintended or unauthorized use, even if such claim alleges that **onsemi** was negligent regarding the design or manufacture of the part. **onsemi** is an Equal Opportunity/Affirmative Action Employer. This literature is subject to all applicable copyright laws and is not for resale in any manner.

ADDITIONAL INFORMATION

TECHNICAL PUBLICATIONS:

Technical Library: www.onsemi.com/design/resources/technical-documentation
onsemi Website: www.onsemi.com

ONLINE SUPPORT: www.onsemi.com/support

For additional information, please contact your local Sales Representative at www.onsemi.com/support/sales