

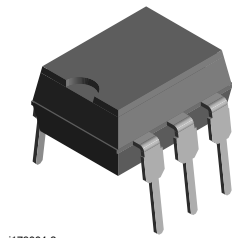

Optocoupler, Phototransistor Output, With Base Connection

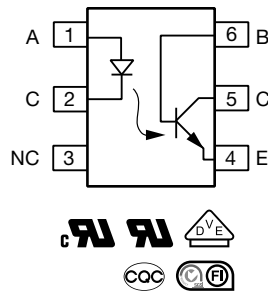

H179004-3



FEATURES

- Isolation test voltage (1.0 s), 5300 V_{RMS}
- V_{CEsat} = 0.25 (≤ 0.4) V, I_F = 10 mA, I_C = 2.5 mA
- Built to conform to VDE requirements
- High quality premium device
- Long term stability
- Storage temperature, -55 °C to +150 °C
- Material categorization: for definitions of compliance please see www.vishay.com/doc?99912



RoHS
COMPLIANT

LINKS TO ADDITIONAL RESOURCES



DESCRIPTION

The SFH600 is an optocoupler with a GaAs LED emitter which is optically coupled with a silicon planar phototransistor detector. The component is packaged in a plastic plug-in case, 20 AB DIN 41866.

The coupler transmits signals between two electrically isolated circuits. The potential difference between the circuits to be coupled should not exceed the maximum permissible insulating voltage.

AGENCY APPROVALS

- [UL 1577](#)
- [cUL](#)
- [DIN EN 60747-5-5 \(VDE 0884\)](#), available with option 1
- [CQC](#)
- [BSI](#)
- [FIMKO](#)

ORDERING INFORMATION			
<div style="display: flex; justify-content: space-around; align-items: center;"> <div style="border: 1px solid black; padding: 2px 5px;">S</div> <div style="border: 1px solid black; padding: 2px 5px;">F</div> <div style="border: 1px solid black; padding: 2px 5px;">H</div> <div style="border: 1px solid black; padding: 2px 5px;">6</div> <div style="border: 1px solid black; padding: 2px 5px;">0</div> <div style="border: 1px solid black; padding: 2px 5px;">0</div> <div style="margin: 0 5px;">-</div> <div style="border: 1px solid black; padding: 2px 5px;">#</div> <div style="margin: 0 5px;">X</div> <div style="border: 1px solid black; padding: 2px 5px;">0</div> <div style="margin: 0 5px;">#</div> <div style="margin: 0 5px;">#</div> <div style="border: 1px solid black; padding: 2px 5px;">T</div> </div> <p style="text-align: center;">PART NUMBER CTR BIN PACKAGE OPTION TAPE AND REEL</p>			
AGENCY CERTIFIED / PACKAGE	CTR (%)		
UL, cUL, BSI, CQC	63 to 125	100 to 200	160 to 320
DIP-6	SFH600-1	SFH600-2	SFH600-3
DIP-6, 400 mil, option 6	-	SFH600-2X006	SFH600-3X006
SMD-6, option 7	SFH600-1X007T ⁽¹⁾	SFH600-2X007	SFH600-3X007
SMD-6, option 9	SFH600-1X009T	-	-
UL, cUL, BSI, CQC, VDE (Option 1)	63 to 125	100 to 200	160 to 320
DIP-6	-	SFH600-2X001	SFH600-3X001
DIP-6, 400 mil, option 6	-	SFH600-2X016	-

Notes

- Additional options may be possible, please contact sales office
- ⁽¹⁾ Also available in tubes; do not put T on the end



ABSOLUTE MAXIMUM RATINGS (T _{amb} = 25 °C, unless otherwise specified)				
PARAMETER	TEST CONDITION	SYMBOL	VALUE	UNIT
INPUT				
Reverse voltage		V _R	6.0	V
DC forward current		I _F	60	mA
Surge forward current	t _p ≤ 10 μs	I _{FSM}	2.5	A
Total power dissipation		P _{diss}	100	mW
OUTPUT				
Collector emitter voltage		V _{CEO}	70	V
Emitter base voltage		V _{EB}	7.0	V
Collector current		I _C	50	mA
	t = 1.0 ms	I _C	100	mA
Power dissipation		P _{diss}	150	mW
COUPLER				
Storage temperature range		T _{stg}	-55 to +150	°C
Ambient temperature range		T _{amb}	-55 to +100	°C
Junction temperature	Max. 10 s, dip soldering	T _j	100	°C
Soldering temperature ⁽¹⁾	Max. 10 s, dip soldering: distance to seating plane ≥ 1.5 mm	T _{sld}	260	°C

Notes

- Stresses in excess of the absolute maximum ratings can cause permanent damage to the device. Functional operation of the device is not implied at these or any other conditions in excess of those given in the operational sections of this document. Exposure to absolute maximum ratings for extended periods of the time can adversely affect reliability
- ⁽¹⁾ Refer to reflow profile for soldering conditions for surface mounted devices (SMD). Refer to wave profile for soldering conditions for through hole devices (DIP)

ELECTRICAL CHARACTERISTICS (T _{amb} = 25 °C, unless otherwise specified)							
PARAMETER	TEST CONDITION	PART	SYMBOL	MIN.	TYP.	MAX.	UNIT
INPUT							
Forward voltage	I _F = 60 mA		V _F	-	1.25	1.65	V
Breakdown voltage	I _R = 10 μA		V _{BR}	6	-	-	V
Reverse current	V _R = 6 V		I _R	-	0.01	10	μA
Capacitance	V _F = 0 V, f = 1 MHz		C _O	-	25	-	pF
Thermal resistance			R _{thja}	-	750	-	K/W
OUTPUT							
Collector emitter capacitance	f = 1 MHz, V _{CE} = 5 V		C _{CE}	-	5.2	-	pF
Collector base capacitance	f = 1 MHz, V _{CB} = 5 V		C _{CB}	-	6.5	-	pF
Emitter base capacitance	f = 1 MHz, V _{EB} = 5 V		C _{EB}	-	9.5	-	pF
Thermal resistance			R _{thja}	-	500	-	K/W
Collector emitter leakage current	V _{CE} = 10 V	SFH600-1	I _{CEO}	-	2	35	nA
		SFH600-2	I _{CEO}	-	2	35	nA
		SFH600-3	I _{CEO}	-	5	70	nA
COUPLER							
Saturation voltage collector emitter voltage	I _F = 10 mA, I _C = 2.5 mA		V _{CEsat}	-	0.25	0.4	V
Capacitance (input to output)			C _{IO}	-	-	0.6	pF

Note

- Minimum and maximum values are testing requirements. Typical values are characteristics of the device and are the result of engineering evaluation. Typical values are for information only and are not part of the testing requirements



CURRENT TRANSFER RATIO							
PARAMETER	TEST CONDITION	PART	SYMBOL	MIN.	TYP.	MAX.	UNIT
I_C/I_F at $V_{CE} = 5.0\text{ V}$	$I_F = 10\text{ mA}$	SFH600-1	CTR	63	-	125	%
		SFH600-2	CTR	100	-	200	%
		SFH600-3	CTR	160	-	320	%
	$I_F = 1\text{ mA}$	SFH600-1	CTR	22	45	-	%
		SFH600-2	CTR	34	70	-	%
		SFH600-3	CTR	56	90	-	%

SWITCHING CHARACTERISTICS							
PARAMETER	TEST CONDITION	PART	SYMBOL	MIN.	TYP.	MAX.	UNIT
NON-SATURATED							
Current	$V_{CC} = 5\text{ V}, R_L = 75\ \Omega$		I_F	-	10	-	mA
Rise time	$V_{CC} = 5\text{ V}, R_L = 75\ \Omega$		t_r	-	2	-	μs
Fall time	$V_{CC} = 5\text{ V}, R_L = 75\ \Omega$		t_f	-	2.5	-	μs
Turn-on time	$V_{CC} = 5\text{ V}, R_L = 75\ \Omega$		t_{on}	-	3.2	-	μs
Turn-off time	$V_{CC} = 5\text{ V}, R_L = 75\ \Omega$		t_{off}	-	3	-	μs
Cut-off frequency	$V_{CC} = 5\text{ V}, R_L = 75\ \Omega$		F_{CO}	-	250	-	kHz
SATURATED							
Current		SFH600-1	I_F	-	10	-	mA
		SFH600-2	I_F	-	10	-	mA
		SFH600-3	I_F	-	5	-	mA
Rise time		SFH600-1	t_r	-	3	-	μs
		SFH600-2	t_r	-	3	-	μs
		SFH600-3	t_r	-	4	-	μs
Fall time		SFH600-1	t_f	-	12	-	μs
		SFH600-2	t_f	-	12	-	μs
		SFH600-3	t_f	-	14	-	μs
Turn-on time		SFH600-1	t_{on}	-	4.5	-	μs
		SFH600-2	t_{on}	-	4.5	-	μs
		SFH600-3	t_{on}	-	5.8	-	μs
Turn-off time		SFH600-1	t_{off}	-	21	-	μs
		SFH600-2	t_{off}	-	21	-	μs
		SFH600-3	t_{off}	-	24	-	μs

SAFETY AND INSULATION RATINGS				
PARAMETER	TEST CONDITION	SYMBOL	VALUE	UNIT
Climatic classification	According to IEC 68 part 1		55 / 100 / 21	
Comparative tracking index		CTI	175	
Maximum rated withstanding isolation voltage	$t = 1\text{ min}$	V_{ISO}	4420	V_{RMS}
Maximum transient isolation voltage		V_{IOTM}	10 000	V
Maximum repetitive peak isolation voltage		V_{IORM}	890	V
Isolation resistance	$V_{IO} = 500\text{ V}, T_{amb} = 25\text{ }^\circ\text{C}$	R_{IO}	$\geq 10^{12}$	Ω
	$V_{IO} = 500\text{ V}, T_{amb} = 100\text{ }^\circ\text{C}$	R_{IO}	$\geq 10^{11}$	Ω
Output safety power		P_{SO}	400	mW
Input safety current		I_{SI}	275	mA
Input safety temperature		T_{SI}	175	$^\circ\text{C}$
Creepage distance			≥ 7	mm
Clearance distance			≥ 7	mm
Insulation thickness		DTI	≥ 0.4	mm

Note

- As per IEC 60747-5-5, § 7.4.3.8.2, this optocoupler is suitable for "safe electrical insulation" only within the safety ratings. Compliance with the safety ratings shall be ensured by means of protective circuits



TYPICAL CHARACTERISTICS ($T_{amb} = 25\text{ }^{\circ}\text{C}$, unless otherwise specified)

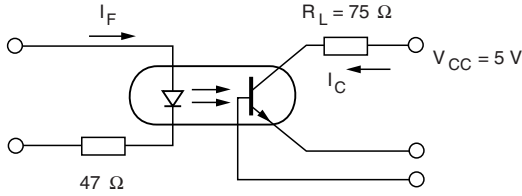

isfh600_01

Fig. 1 - Linear Operation (without saturation)

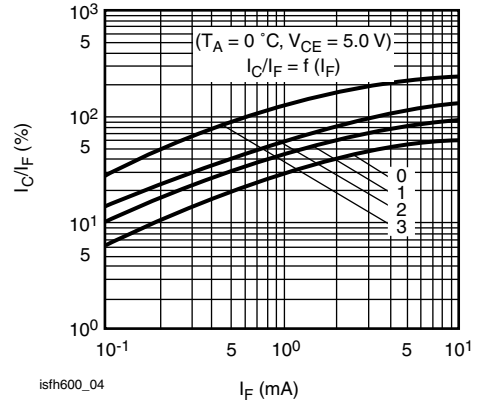

isfh600_04

Fig. 4 - Current Transfer Ratio vs. Diode Current

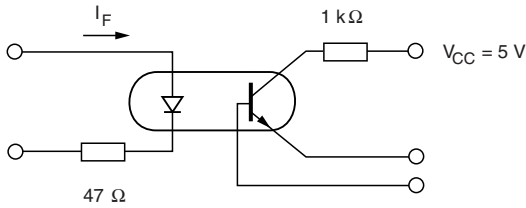

isfh600_02

Fig. 2 - Switching Operation (with saturation)

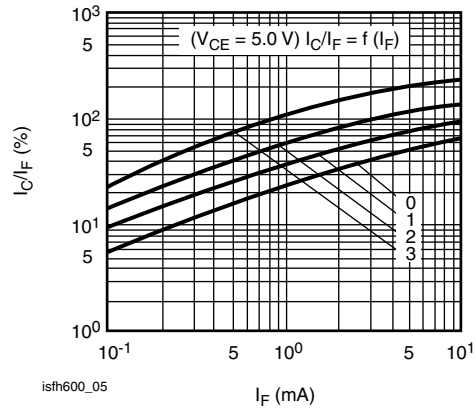

isfh600_05

Fig. 5 - Current Transfer Ratio vs. Diode Current

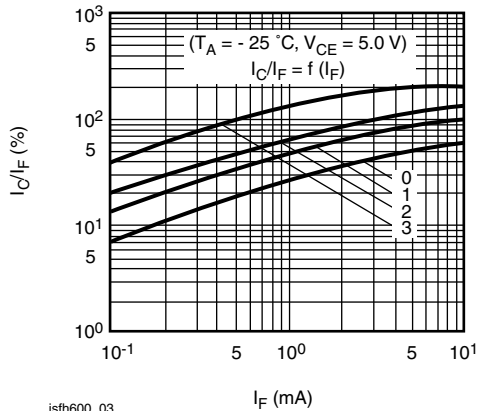

isfh600_03

Fig. 3 - Current Transfer Ratio vs. Diode Current

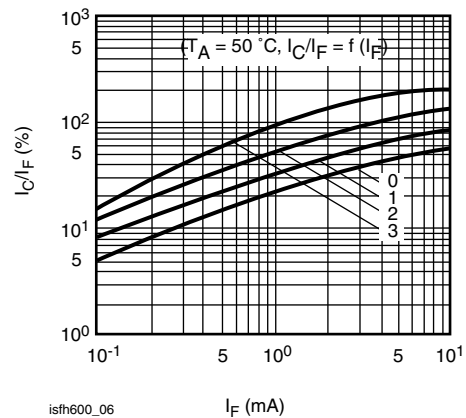

isfh600_06

Fig. 6 - Current Transfer Ratio vs. Diode Current

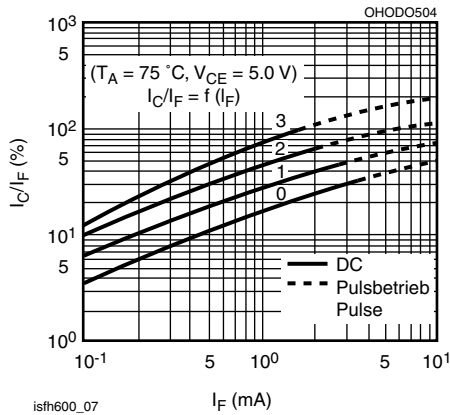

Fig. 7 - Current Transfer Ratio vs. Diode Current

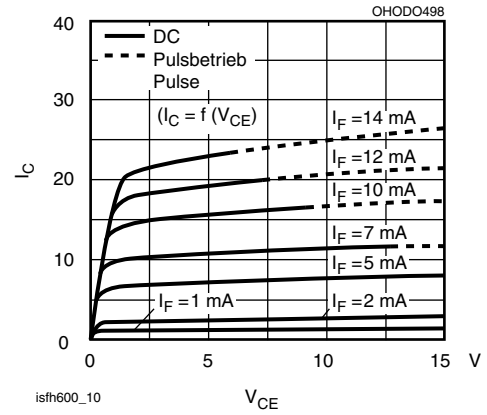

Fig. 10 - Output Characteristics SFH600-2, SFH600-3

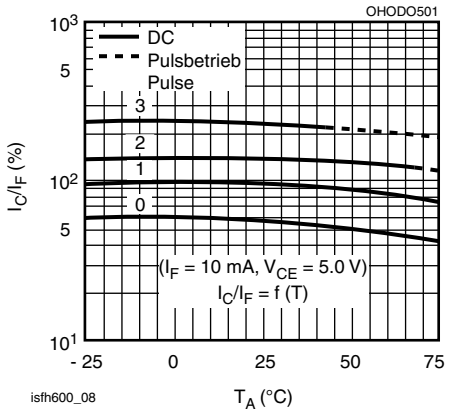

Fig. 8 - Current Transfer Ratio (CTR) vs. Temperature

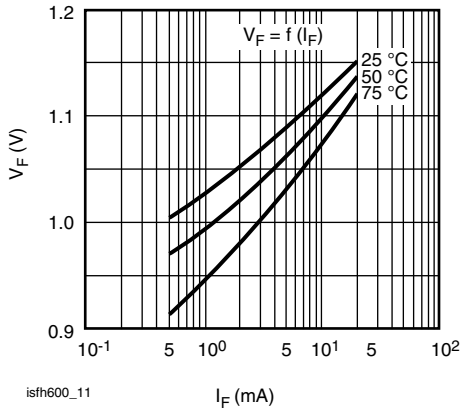

Fig. 11 - Forward Voltage

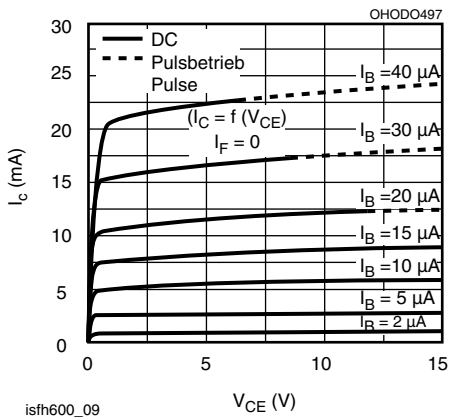

Fig. 9 - Transistor Characteristics SFH600-2, SFH600-3

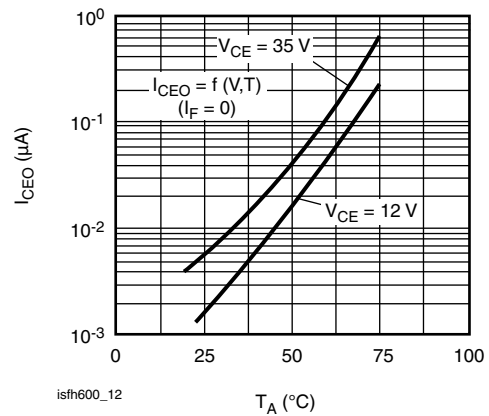

Fig. 12 - Collector Emitter Off-State Current

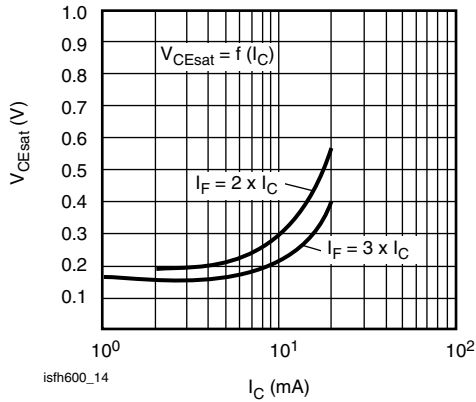

Fig. 13 - Saturation Voltage vs. Collector Current and Modulation Depth SFH600-1

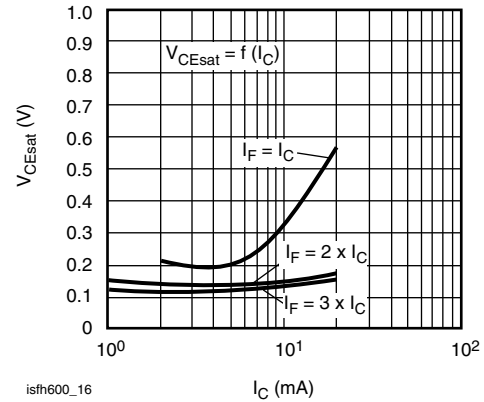

Fig. 16 - Permissible Pulse Load

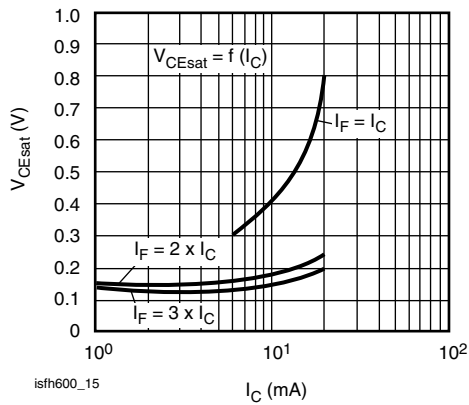

Fig. 14 - Saturation Voltage vs. Collector Current and Modulation Depth SFH600-2

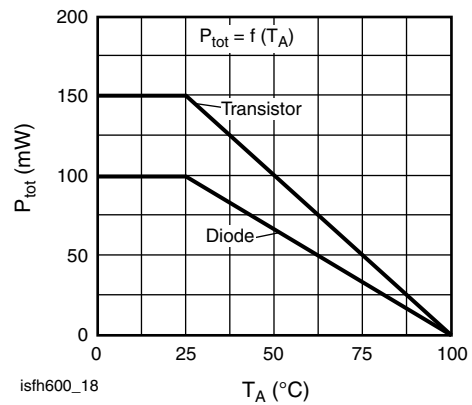

Fig. 17 - Permissible Power Dissipation for Transistor and Diode

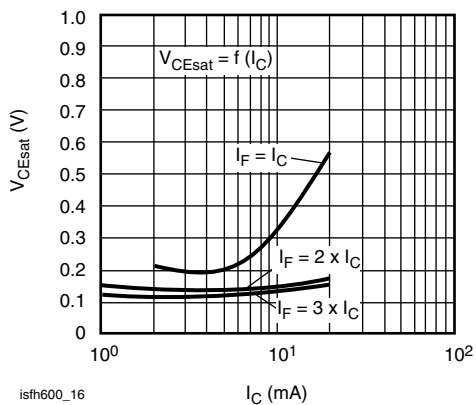

Fig. 15 - Saturation Voltage vs. Collector Current and Modulation Depth SFH600-3

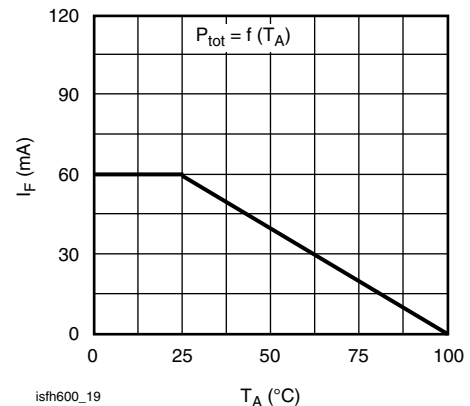

Fig. 18 - Permissible Forward Current Diode

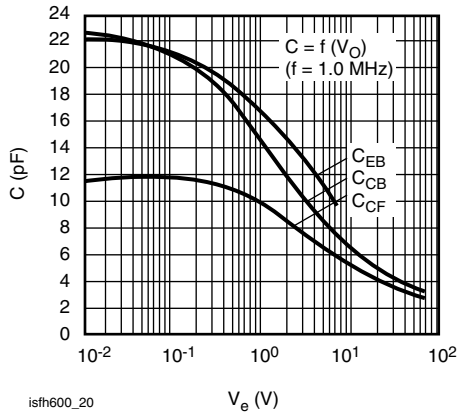
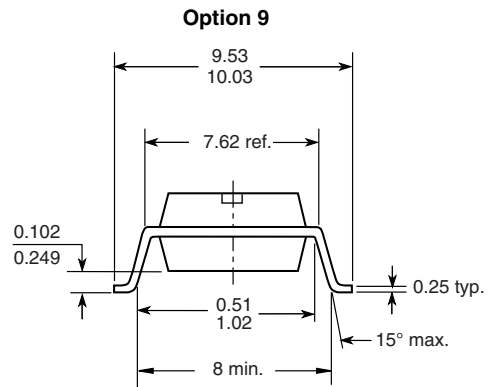
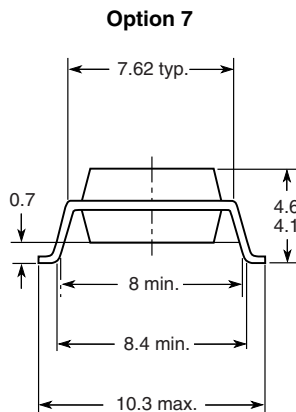
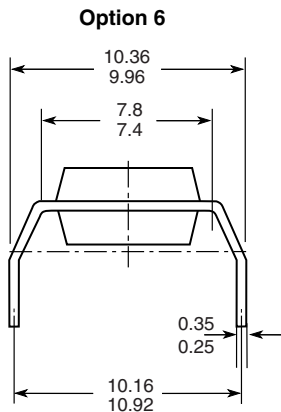
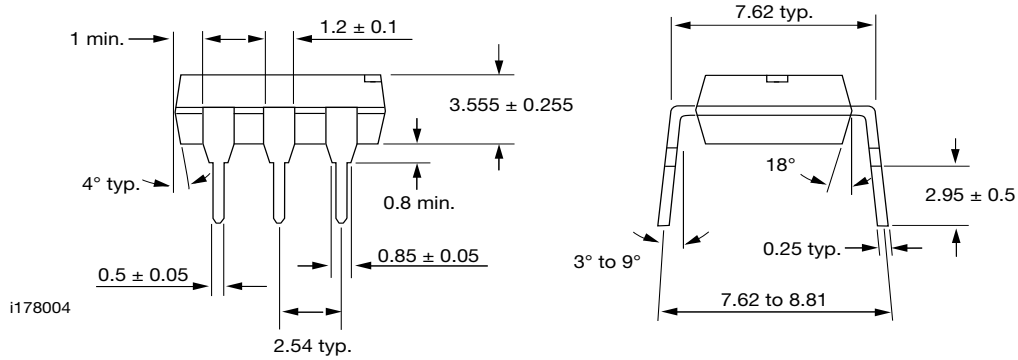
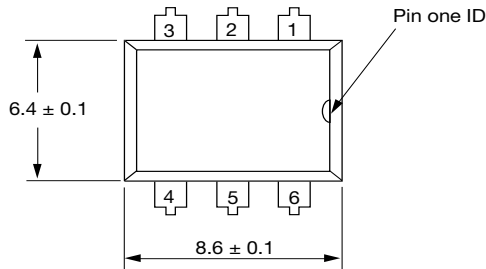

Fig. 19 - Transistor Capacitance

PACKAGE DIMENSIONS in inches (millimeters)



18450



PACKAGE MARKING (example)

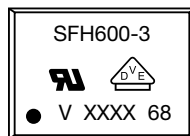

Fig. 20 - Example of SFH600-3X001

Notes

- XXXX = LMC (lot marking code)
- VDE logo is only marked on option 1 parts
- Tape and reel suffix (T) is not part of the package marking



DIP-6A

PACKAGE DIMENSIONS in inches (millimeters)

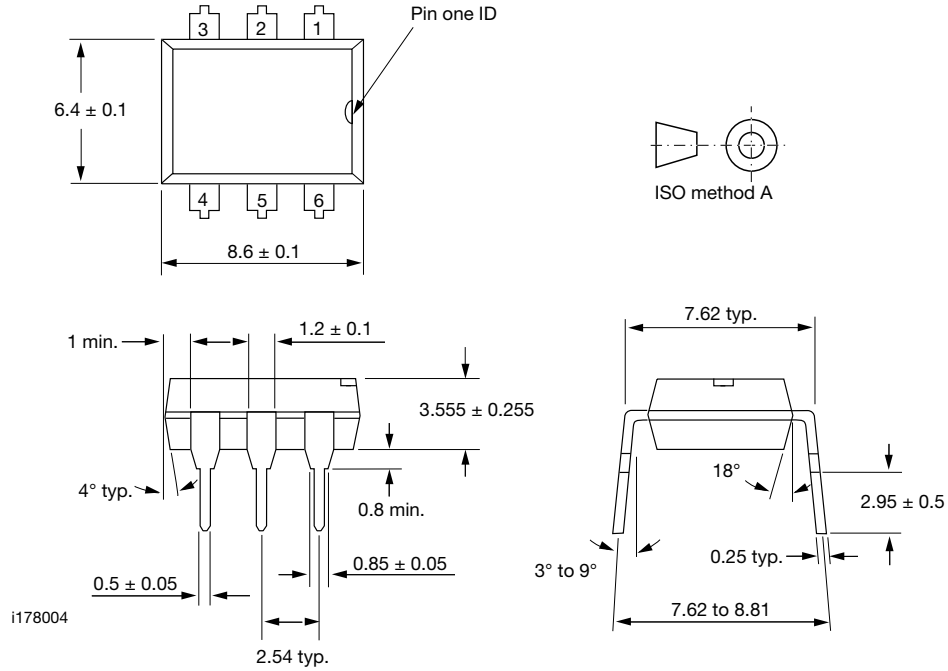

Note

The information in this document provides generic information but for specific information on a product the appropriate product datasheet should be used.



Disclaimer

ALL PRODUCT, PRODUCT SPECIFICATIONS AND DATA ARE SUBJECT TO CHANGE WITHOUT NOTICE TO IMPROVE RELIABILITY, FUNCTION OR DESIGN OR OTHERWISE.

Vishay Intertechnology, Inc., its affiliates, agents, and employees, and all persons acting on its or their behalf (collectively, "Vishay"), disclaim any and all liability for any errors, inaccuracies or incompleteness contained in any datasheet or in any other disclosure relating to any product.

Vishay makes no warranty, representation or guarantee regarding the suitability of the products for any particular purpose or the continuing production of any product. To the maximum extent permitted by applicable law, Vishay disclaims (i) any and all liability arising out of the application or use of any product, (ii) any and all liability, including without limitation special, consequential or incidental damages, and (iii) any and all implied warranties, including warranties of fitness for particular purpose, non-infringement and merchantability.

Statements regarding the suitability of products for certain types of applications are based on Vishay's knowledge of typical requirements that are often placed on Vishay products in generic applications. Such statements are not binding statements about the suitability of products for a particular application. It is the customer's responsibility to validate that a particular product with the properties described in the product specification is suitable for use in a particular application. Parameters provided in datasheets and / or specifications may vary in different applications and performance may vary over time. All operating parameters, including typical parameters, must be validated for each customer application by the customer's technical experts. Product specifications do not expand or otherwise modify Vishay's terms and conditions of purchase, including but not limited to the warranty expressed therein.

Hyperlinks included in this datasheet may direct users to third-party websites. These links are provided as a convenience and for informational purposes only. Inclusion of these hyperlinks does not constitute an endorsement or an approval by Vishay of any of the products, services or opinions of the corporation, organization or individual associated with the third-party website. Vishay disclaims any and all liability and bears no responsibility for the accuracy, legality or content of the third-party website or for that of subsequent links.

Except as expressly indicated in writing, Vishay products are not designed for use in medical, life-saving, or life-sustaining applications or for any other application in which the failure of the Vishay product could result in personal injury or death. Customers using or selling Vishay products not expressly indicated for use in such applications do so at their own risk. Please contact authorized Vishay personnel to obtain written terms and conditions regarding products designed for such applications.

No license, express or implied, by estoppel or otherwise, to any intellectual property rights is granted by this document or by any conduct of Vishay. Product names and markings noted herein may be trademarks of their respective owners.