

MBD701, MMBD701L, SMMBD701L



ON Semiconductor®

www.onsemi.com

Silicon Hot-Carrier Diodes Schottky Barrier Diodes

These devices are designed primarily for high-efficiency UHF and VHF detector applications. They are readily adaptable to many other fast switching RF and digital applications. They are supplied in an inexpensive plastic package for low-cost, high-volume consumer and industrial/commercial requirements. They are also available in a Surface Mount package.

Features

- Extremely Low Minority Carrier Lifetime – 15 ps (Typ)
- Very Low Capacitance – 1.0 pF @ $V_R = 20$ V
- High Reverse Voltage – to 70 V
- Low Reverse Leakage – 200 nA (Max)
- S Prefix for Automotive and Other Applications Requiring Unique Site and Control Change Requirements; AEC Qualified and PPAP Capable
- These Devices are Pb-Free and are RoHS Compliant

MAXIMUM RATINGS

Rating	Symbol	Value	Unit
Reverse Voltage	V_R	70	V
Forward Power Dissipation @ $T_A = 25^\circ\text{C}$ MBD701 MMBD701L, SMMBD701L	P_F	280 200	mW
Derate above 25°C MBD701 MMBD701L, SMMBD701L		2.8 2.0	mW/ $^\circ\text{C}$
Operating Junction Temperature Range	T_J	-55 to +125	$^\circ\text{C}$
Storage Temperature Range	T_{stg}	-55 to +150	$^\circ\text{C}$

Stresses exceeding those listed in the Maximum Ratings table may damage the device. If any of these limits are exceeded, device functionality should not be assumed, damage may occur and reliability may be affected.



TO-92 2-Lead
CASE 182
STYLE 1

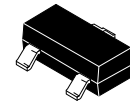

SOT-23 (TO-236)
CASE 318
STYLE 8

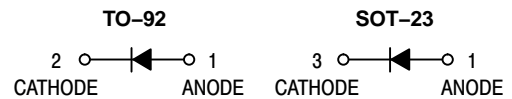

MARKING DIAGRAMS

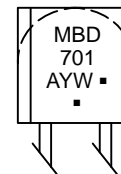

TO-92

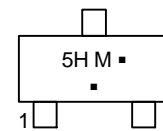

SOT-23

- A = Assembly Location
- Y = Year
- W = Work Week
- 5H = Device Code (SOT-23)
- M = Date Code*
- = Pb-Free Package

(Note: Microdot may be in either location)

*Date Code orientation and/or overbar may vary depending upon manufacturing location.

ORDERING INFORMATION

See detailed ordering and shipping information in the package dimensions section on page 2 of this data sheet.

MBD701, MMBD701L, SMMBD701L

ELECTRICAL CHARACTERISTICS ($T_A = 25^\circ\text{C}$ unless otherwise noted)

Characteristic	Symbol	Min	Typ	Max	Unit
Reverse Breakdown Voltage ($I_R = 10 \mu\text{A}_{dc}$)	$V_{(BR)R}$	70	–	–	V
Total Capacitance ($V_R = 20 \text{ V}$, $f = 1.0 \text{ MHz}$) Figure 1	C_T	–	0.5	1.0	pF
Reverse Leakage ($V_R = 35 \text{ V}$) Figure 3	I_R	–	9.0	200	nA _{dc}
Forward Voltage ($I_F = 1.0 \text{ mA}_{dc}$) Figure 4	V_F	–	0.42	0.5	V _{dc}
Forward Voltage ($I_F = 10 \text{ mA}_{dc}$) Figure 4	V_F	–	0.7	1.0	V _{dc}

Product parametric performance is indicated in the Electrical Characteristics for the listed test conditions, unless otherwise noted. Product performance may not be indicated by the Electrical Characteristics if operated under different conditions.

ORDERING INFORMATION

Device	Package	Shipping†
MBD701G	TO-92 (Pb-Free)	1,000 Units / Bulk
MMBD701LT1G	SOT-23 (Pb-Free)	3,000 / Tape & Reel
SMMBD701LT1G	SOT-23 (Pb-Free)	3,000 / Tape & Reel
MMBD701LT3G	SOT-23 (Pb-Free)	10,000 / Tape & Reel

†For information on tape and reel specifications, including part orientation and tape sizes, please refer to our Tape and Reel Packaging Specifications Brochure, BRD8011/D.

MBD701, MMBD701L, SMMBD701L

TYPICAL ELECTRICAL CHARACTERISTICS

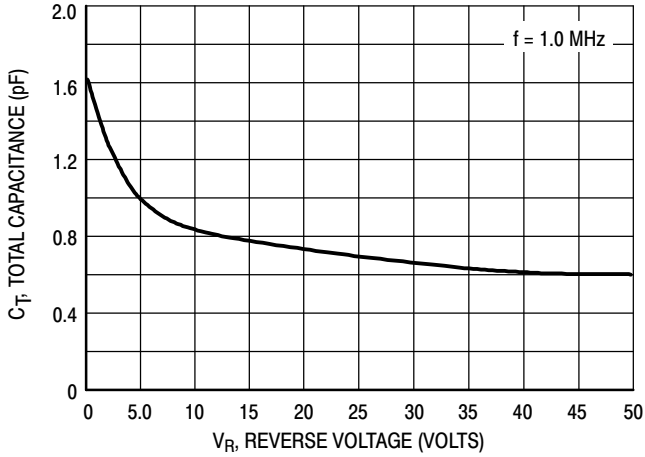

Figure 1. Total Capacitance

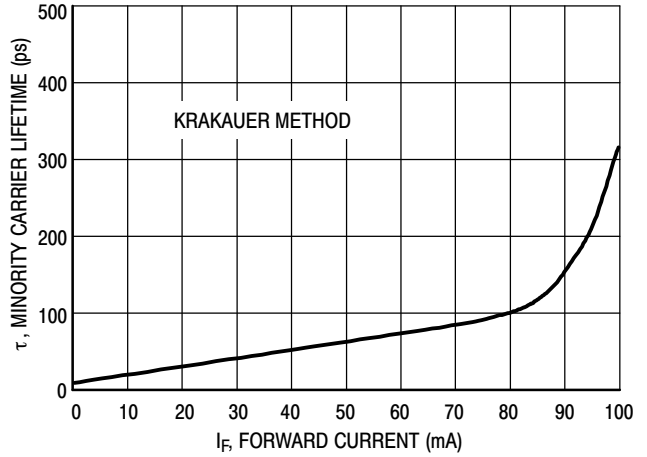

Figure 2. Minority Carrier Lifetime

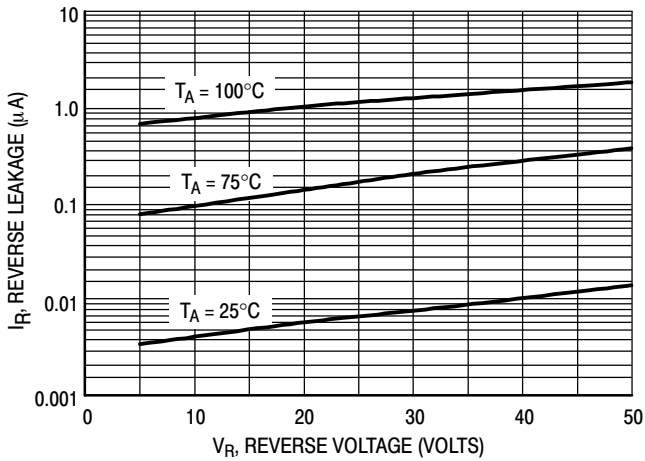

Figure 3. Reverse Leakage

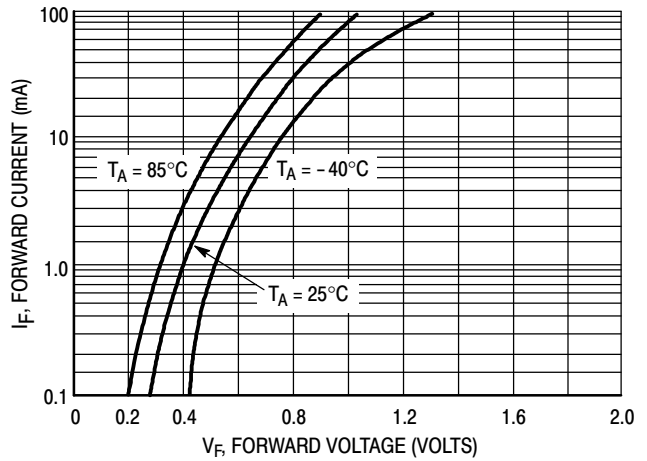

Figure 4. Forward Voltage

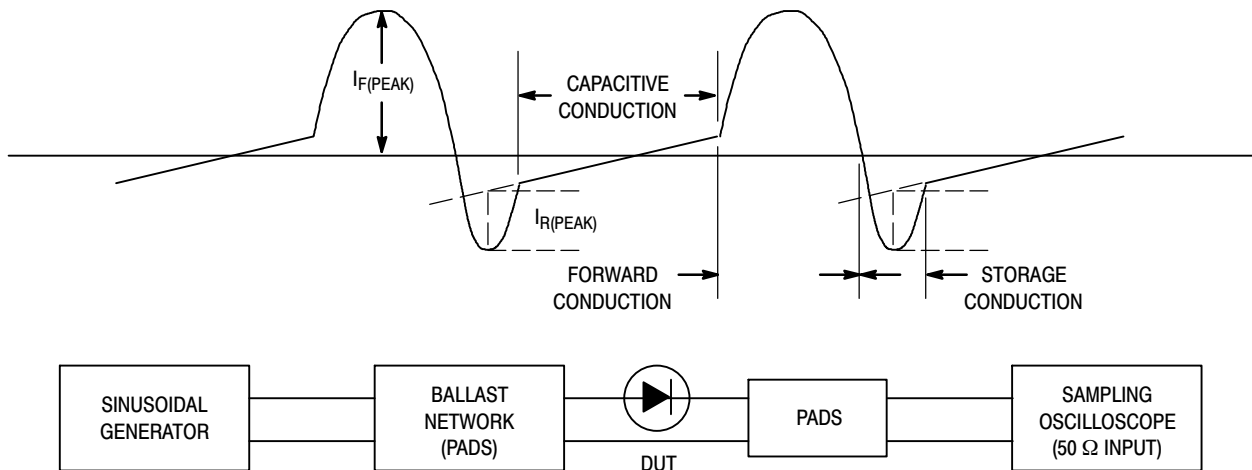

Figure 5. Krakauer Method of Measuring Lifetime

MECHANICAL CASE OUTLINE

PACKAGE DIMENSIONS

ON Semiconductor®



TO-92 (TO-226)
CASE 182-06
ISSUE L

DATE 04/18/1998

SCALE 1:1

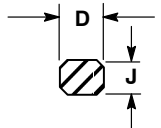
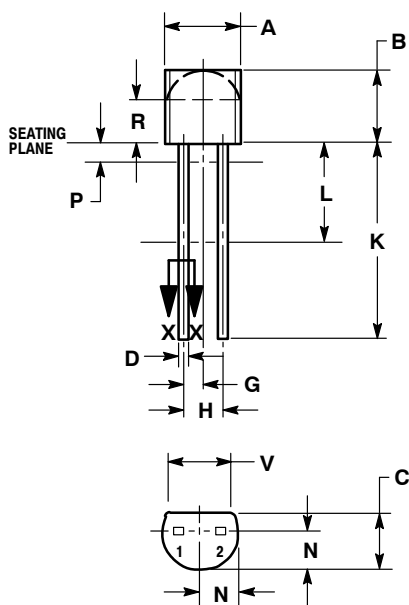

- NOTES:
1. DIMENSIONING AND TOLERANCING PER ANSI Y14.5M, 1982.
 2. CONTROLLING DIMENSION: INCH.
 3. CONTOUR OF PACKAGE BEYOND ZONE R IS UNCONTROLLED.
 4. LEAD DIMENSION IS UNCONTROLLED IN P AND BEYOND DIMENSION K MINIMUM.

DIM	INCHES		MILLIMETERS	
	MIN	MAX	MIN	MAX
A	0.175	0.205	4.45	5.21
B	0.170	0.210	4.32	5.33
C	0.125	0.165	3.18	4.19
D	0.016	0.021	0.407	0.533
G	0.050 BSC		1.27 BSC	
H	0.100 BSC		2.54 BSC	
J	0.014	0.016	0.36	0.41
K	0.500	---	12.70	---
L	0.250	---	6.35	---
N	0.080	0.105	2.03	2.66
P	---	0.050	---	1.27
R	0.115	---	2.93	---
V	0.135	---	3.43	---

- STYLE 1: PIN 1. ANODE
2. CATHODE
- STYLE 2: PIN 1. CATHODE
2. ANODE
- STYLE 3: PIN 1. MAIN TERMINAL 1
2. MAIN TERMINAL 2
- STYLE 4: CANCELLED
- STYLE 5: PIN 1. INPUT
2. OUTPUT

DOCUMENT NUMBER:	98ASB42118B	Electronic versions are uncontrolled except when accessed directly from the Document Repository. Printed versions are uncontrolled except when stamped "CONTROLLED COPY" in red.
DESCRIPTION:	TO-92 (TO-226)	PAGE 1 OF 1

ON Semiconductor and are trademarks of Semiconductor Components Industries, LLC dba ON Semiconductor or its subsidiaries in the United States and/or other countries. ON Semiconductor reserves the right to make changes without further notice to any products herein. ON Semiconductor makes no warranty, representation or guarantee regarding the suitability of its products for any particular purpose, nor does ON Semiconductor assume any liability arising out of the application or use of any product or circuit, and specifically disclaims any and all liability, including without limitation special, consequential or incidental damages. ON Semiconductor does not convey any license under its patent rights nor the rights of others.

MECHANICAL CASE OUTLINE PACKAGE DIMENSIONS



SOT-23 (TO-236)
CASE 318
ISSUE AT

DATE 01 MAR 2023

SCALE 4:1



NOTES:

1. DIMENSIONING AND TOLERANCING PER ASME Y14.5M,1994.
2. CONTROLLING DIMENSION: MILLIMETERS
3. MAXIMUM LEAD THICKNESS INCLUDES LEAD FINISH. MINIMUM LEAD THICKNESS IS THE MINIMUM THICKNESS OF THE BASE MATERIAL.
4. DIMENSIONS D AND E DO NOT INCLUDE MOLD FLASH, PROTRUSIONS, OR GATE BURRS.

DIM	MILLIMETERS			INCHES		
	MIN.	NOM.	MAX.	MIN.	NOM.	MAX.
A	0.89	1.00	1.11	0.035	0.039	0.044
A1	0.01	0.06	0.10	0.000	0.002	0.004
b	0.37	0.44	0.50	0.015	0.017	0.020
c	0.08	0.14	0.20	0.003	0.006	0.008
D	2.80	2.90	3.04	0.110	0.114	0.120
E	1.20	1.30	1.40	0.047	0.051	0.055
e	1.78	1.90	2.04	0.070	0.075	0.080
L	0.30	0.43	0.55	0.012	0.017	0.022
L1	0.35	0.54	0.69	0.014	0.021	0.027
H _E	2.10	2.40	2.64	0.083	0.094	0.104
T	0°	---	10°	0°	---	10°

GENERIC MARKING DIAGRAM*



- XXX = Specific Device Code
- M = Date Code
- = Pb-Free Package

*This information is generic. Please refer to device data sheet for actual part marking. Pb-Free indicator, "G" or microdot "▪", may or may not be present. Some products may not follow the Generic Marking.



RECOMMENDED MOUNTING FOOTPRINT

* For additional information on our Pb-Free strategy and soldering details, please download the ON Semiconductor Soldering and Mounting Techniques Reference Manual, SOLDERRM/D.

STYLES ON PAGE 2

DOCUMENT NUMBER:	98ASB42226B	Electronic versions are uncontrolled except when accessed directly from the Document Repository. Printed versions are uncontrolled except when stamped "CONTROLLED COPY" in red.
DESCRIPTION:	SOT-23 (TO-236)	PAGE 1 OF 2

onsemi and ONSEMI are trademarks of Semiconductor Components Industries, LLC dba onsemi or its subsidiaries in the United States and/or other countries. onsemi reserves the right to make changes without further notice to any products herein. onsemi makes no warranty, representation or guarantee regarding the suitability of its products for any particular purpose, nor does onsemi assume any liability arising out of the application or use of any product or circuit, and specifically disclaims any and all liability, including without limitation special, consequential or incidental damages. onsemi does not convey any license under its patent rights nor the rights of others.

MECHANICAL CASE OUTLINE

PACKAGE DIMENSIONS



SOT-23 (TO-236) CASE 318 ISSUE AT

DATE 01 MAR 2023

STYLE 1 THRU 5: CANCELLED	STYLE 6: PIN 1. BASE 2. EMITTER 3. COLLECTOR	STYLE 7: PIN 1. EMITTER 2. BASE 3. COLLECTOR	STYLE 8: PIN 1. ANODE 2. NO CONNECTION 3. CATHODE		
STYLE 9: PIN 1. ANODE 2. ANODE 3. CATHODE	STYLE 10: PIN 1. DRAIN 2. SOURCE 3. GATE	STYLE 11: PIN 1. ANODE 2. CATHODE 3. CATHODE-ANODE	STYLE 12: PIN 1. CATHODE 2. CATHODE 3. ANODE	STYLE 13: PIN 1. SOURCE 2. DRAIN 3. GATE	STYLE 14: PIN 1. CATHODE 2. GATE 3. ANODE
STYLE 15: PIN 1. GATE 2. CATHODE 3. ANODE	STYLE 16: PIN 1. ANODE 2. CATHODE 3. CATHODE	STYLE 17: PIN 1. NO CONNECTION 2. ANODE 3. CATHODE	STYLE 18: PIN 1. NO CONNECTION 2. CATHODE 3. ANODE	STYLE 19: PIN 1. CATHODE 2. ANODE 3. CATHODE-ANODE	STYLE 20: PIN 1. CATHODE 2. ANODE 3. GATE
STYLE 21: PIN 1. GATE 2. SOURCE 3. DRAIN	STYLE 22: PIN 1. RETURN 2. OUTPUT 3. INPUT	STYLE 23: PIN 1. ANODE 2. ANODE 3. CATHODE	STYLE 24: PIN 1. GATE 2. DRAIN 3. SOURCE	STYLE 25: PIN 1. ANODE 2. CATHODE 3. GATE	STYLE 26: PIN 1. CATHODE 2. ANODE 3. NO CONNECTION
STYLE 27: PIN 1. CATHODE 2. CATHODE 3. CATHODE	STYLE 28: PIN 1. ANODE 2. ANODE 3. ANODE				

DOCUMENT NUMBER:	98ASB42226B	Electronic versions are uncontrolled except when accessed directly from the Document Repository. Printed versions are uncontrolled except when stamped "CONTROLLED COPY" in red.
DESCRIPTION:	SOT-23 (TO-236)	PAGE 2 OF 2

onsemi and **ONSEMI** are trademarks of Semiconductor Components Industries, LLC dba **onsemi** or its subsidiaries in the United States and/or other countries. **onsemi** reserves the right to make changes without further notice to any products herein. **onsemi** makes no warranty, representation or guarantee regarding the suitability of its products for any particular purpose, nor does **onsemi** assume any liability arising out of the application or use of any product or circuit, and specifically disclaims any and all liability, including without limitation special, consequential or incidental damages. **onsemi** does not convey any license under its patent rights nor the rights of others.

onsemi, **Onsemi**, and other names, marks, and brands are registered and/or common law trademarks of Semiconductor Components Industries, LLC dba "**onsemi**" or its affiliates and/or subsidiaries in the United States and/or other countries. **onsemi** owns the rights to a number of patents, trademarks, copyrights, trade secrets, and other intellectual property. A listing of **onsemi**'s product/patent coverage may be accessed at www.onsemi.com/site/pdf/Patent-Marking.pdf. **onsemi** reserves the right to make changes at any time to any products or information herein, without notice. The information herein is provided "as-is" and **onsemi** makes no warranty, representation or guarantee regarding the accuracy of the information, product features, availability, functionality, or suitability of its products for any particular purpose, nor does **onsemi** assume any liability arising out of the application or use of any product or circuit, and specifically disclaims any and all liability, including without limitation special, consequential or incidental damages. Buyer is responsible for its products and applications using **onsemi** products, including compliance with all laws, regulations and safety requirements or standards, regardless of any support or applications information provided by **onsemi**. "Typical" parameters which may be provided in **onsemi** data sheets and/or specifications can and do vary in different applications and actual performance may vary over time. All operating parameters, including "Typicals" must be validated for each customer application by customer's technical experts. **onsemi** does not convey any license under any of its intellectual property rights nor the rights of others. **onsemi** products are not designed, intended, or authorized for use as a critical component in life support systems or any FDA Class 3 medical devices or medical devices with a same or similar classification in a foreign jurisdiction or any devices intended for implantation in the human body. Should Buyer purchase or use **onsemi** products for any such unintended or unauthorized application, Buyer shall indemnify and hold **onsemi** and its officers, employees, subsidiaries, affiliates, and distributors harmless against all claims, costs, damages, and expenses, and reasonable attorney fees arising out of, directly or indirectly, any claim of personal injury or death associated with such unintended or unauthorized use, even if such claim alleges that **onsemi** was negligent regarding the design or manufacture of the part. **onsemi** is an Equal Opportunity/Affirmative Action Employer. This literature is subject to all applicable copyright laws and is not for resale in any manner.

ADDITIONAL INFORMATION

TECHNICAL PUBLICATIONS:

Technical Library: www.onsemi.com/design/resources/technical-documentation
onsemi Website: www.onsemi.com

ONLINE SUPPORT: www.onsemi.com/support

For additional information, please contact your local Sales Representative at www.onsemi.com/support/sales