

1 - Contactors

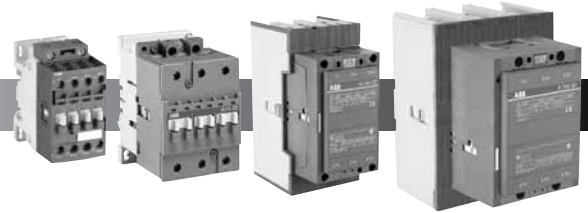

Motor protection & control panorama..... 1.1 – 1.6

Features.....	1.1
3 Pole	
Mini-contactors.....	1.2 - 1.3
Contactors.....	1.2 - 1.3
Main accessories.....	1.2 - 1.3
Overload relays.....	1.2 - 1.3
Manual motor starters.....	1.2 - 1.3
4 Pole	
Mini-contactors.....	1.3 - 1.4
Contactors.....	1.3 - 1.4
Control relays & mini-control relays.....	1.3 - 1.4
Specialty contactors	
Bar contactors.....	1.3 - 1.4
DC circuit switching.....	1.3 - 1.4
Definite purpose.....	1.3 - 1.4
Lighting contactors.....	1.3 - 1.4
Capacitive switching.....	1.3 - 1.4
Railway applications.....	1.3 - 1.4
Dynamic braking / DC drives.....	1.3 - 1.4

Across the line contactors..... 1.7 – 1.166

Features.....	1.7
General information	
Technical terms and definitions.....	1.8
IEC Standards, utilization categories.....	1.9
Motor ratings.....	1.10
Pilot duty ratings and overload trip classes.....	1.11
AF Series contactors.....	1.12 - 1.13
Selection	
AF non-reversing, 3 pole.....	1.14
AF mechanically interlocked & reversing, 3 pole.....	1.15
AFZ non-reversing, 3 pole.....	1.16
AFZ mechanically interlocked, reversing, 3 pole.....	1.17
A non-reversing, 3 pole.....	1.18
A mechanically interlocked, reversing, 3 pole.....	1.19
AE non-reversing, 3 pole.....	1.20
AE mechanically interlocked, reversing, 3 pole.....	1.21
AL non-reversing, 3 pole.....	1.22
AL mechanically interlocked, reversing, 3 pole.....	1.23
AS / ASL non-reversing, reversing 3 pole.....	1.24
AS / ASL non-reversing, spring-terminated, 3 pole.....	1.25
B miniature non-reversing, mechanically interlocked, 3 pole.....	1.26
BC miniature non-reversing, mech. interlocked, 3 pole.....	1.27
AF / AFZ NEMA rated, non-reversing, 3-pole.....	1.28
AF / AFZ NEMA rated, mech. interlocked, reversing, 3-pole.....	1.29
A, AL, AE NEMA rated, non-reversing, 3-pole.....	1.30
A, AL, AE NEMA rated, mech. interlocked, reversing.....	1.31
AF, AFZ, and EK 4-pole.....	1.32
A, AL, and AE 4-pole.....	1.33
B, BC miniature, 4-pole.....	1.34
Additional coil voltages.....	1.35
Accessory fitting details.....	1.36 - 1.44
Coordination with short-circuit protection devices.....	1.45
Auxiliary contact blocks.....	1.46 - 1.51
Surge suppressors for contactor coils.....	1.52 - 1.53
Interface relays.....	1.54 - 1.55
Mechanical & electrical interlocks.....	1.56 - 1.57
Mechanical latching unit.....	1.58
Electronic timers.....	1.59
Electronic timers for wye-delta starters.....	1.60 - 1.61

Connection kits (reversing & phase-to-phase).....	1.62
Connection sets (wye-delta).....	1.63
Coupling units.....	1.64 - 1.65
Terminal enlargements/extensions & shorting bars.....	1.66
Terminal control leads, blocks & lug kits.....	1.67
Terminal shrouds.....	1.68
Function markers, protective covers & coil terminal blocks.....	1.69
Mounting plates.....	1.70
Adapter plates & accessories.....	1.71
Replacement parts.....	1.72 - 1.74
Terminal marking and positioning.....	1.75 - 1.82
Technical data.....	1.83 - 1.146
Approximate dimensions.....	1.147 - 1.166

Capacitive contactors..... 1.167 – 1.174

Features.....	1.167
Contactors for capacitive switching.....	1.168
Selection	
UA, UA...RA 3 pole.....	1.169
Technical data.....	1.170 - 1.173
Approximate dimensions.....	1.174

Definite purpose contactors..... 1.175 - 1.184

Features.....	1.175
DP non-reversing 1, 2, 3 & 4 pole.....	1.176
Accessories.....	1.177
Technical data.....	1.178 - 1.179
Approximate dimensions.....	1.180 - 1.183

Dynamic braking / DC drive..... 1.185 – 1.194

Features.....	1.185
Selection	
EHDB, DA75 2- & 3-pole, non-reversing.....	1.186
EHDB, DA75 2 & 3 pole, mechanically-interlocked.....	1.187
Replacement parts.....	1.188 - 1.189
Technical data.....	1.190 - 1.191
Approximate dimensions.....	1.192 - 1.193

Lighting contactors..... 1.195 – 1.200

Features.....	1.195
A9 - A300 Electrically & mechanically held.....	1.196 - 1.197
Accessories.....	1.198
Factory modifications.....	1.198

Railway application contactors..... 1.201 – 1.206

Features.....	1.201
Reference standards.....	1.202
Selection	
Standard devices, ring-tongue, 3-pole.....	1.203
Traction-specific, ring-tongue, 3-pole.....	1.204
Traction-specific, ring-tongue, 4-pole & relays.....	1.205
Accessories.....	1.206

Continued next page

DC Circuit switching contactors..... 1.207 – 1.214

Features 1.207

Selection

GA75 - GAE75 1.208

GAF185 - GAF2050 1.209

Technical data 1.210 - 1.211

Connections 1.212

Approximate dimensions 1.213 - 1.214

Bar contactors..... 1.215 – 1.224

Features 1.215

Overview 1.216 - 1.217

Bar contactors for the AC circuits switching..... 1.218 - 1.219

Bar contactors for the DC circuits switching 1.220 - 1.221

Questionnaire 1.222 - 1.223

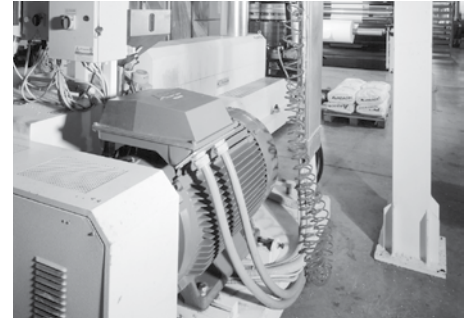
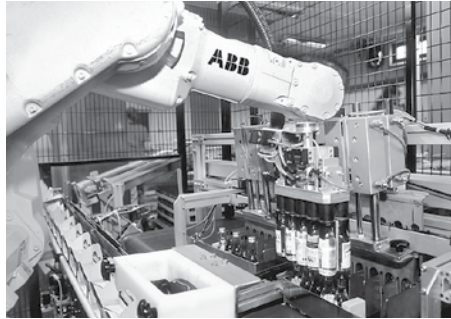

Miniature contactors for compact equipment up to 5 hp / 5.5 kW
Standard contactors for all industrial applications up to 2700 A
Motor starting up to 1150 hp / 900 kW
Contactors for heavy duty applications up to 5000 A, 1500V

Simple, sustainable integration

- Complete 3- & 4-pole ranges
- High performance and quality
- Ease of installation
- AF contactors with electronic coils:
 - Wide input ranges
 - Unified AC/DC voltages
 - Chatter-proof / hum-free
 - Dips withstand
 - Integral surge suppression
- Global certification and approvals

The right choice for many applications

- Pumps & compressors
- HVAC equipment
- Power supplies and batteries
- Material handling
- Alternative energy
- Traction / rail
- Mobile equipment

Motor starting solutions

- Simple, compact assembly
- Close couplers, busbar and terminal accessories
- Systems concept:
 - Reduced panel space
 - Time / cost saving
 - Secure assembly

3-pole contactors

1

Mini contactors



Contactors for all industrial applications and motor starting



IEC	AC-3 Rated operational power	$\theta \leq 55\text{ }^\circ\text{C}^*$, 400 V	kW	4	5.5	4	5.5	7.5	4	5.5	7.5	11	15	18.5
UL/CSA	3-phase motor rating	480 V	hp	3	5	5	7.5	10	5	7.5	10	15	20	—
	AC Control supply		Type	B6	B7	AS09	AS12	AS16	AF09 AF09Z	AF12 AF12Z	AF16 AF16Z	AF26 AF26Z	AF30 AF30Z	AF38 AF38Z
	DC Control supply		Type	BC6	BC7	ASL09	ASL12	ASL16	AF09 AF09Z	AF12 AF12Z	AF16 AF16Z	AF26 AF26Z	AF30 AF30Z	AF38 AF38Z
	AC / DC Control supply		Type	—	—	—	—	—	AF09 AF09Z	AF12 AF12Z	AF16 AF16Z	AF26 AF26Z	AF30 AF30Z	AF38 AF38Z
IEC	AC-3 Rated operational current	$\theta \leq 55\text{ }^\circ\text{C}^*$, 400 V	A	9	12	9	12	15.5	9	12	18	26	32	38
	AC-1 Rated operational current	$\theta \leq 40\text{ }^\circ\text{C}$, 690 V	A	16	20	22	24	24	25	28	30	45	50	50
UL/CSA	General use rating	600 V	A	12 (300 V)	16	20	20	20	25	28	30	45	50	50
NEMA	NEMA Size			—	—	—	—	—	00	0	—	1	—	—
* $\theta \leq 60\text{ }^\circ\text{C}$ for AS(L)09 ... AS(L)16 and AF09 ... AF38 contactors				Pages 1.26...1.27			Pages 1.24...1.25			Pages 1.14...1.17				

Main accessories

Auxiliary contact blocks Pages 1.46...1.51	Front mounting	CAF6	CA3-10 (1 x N.O.), CA3-01 (1 x N.C.)	CA4-10 (1 x N.O.), CA4-01 (1 x N.C.)
Timers Page 1.59	Side mounting	CA6	TEF3-ON, TEF3-OFF	CAL4-11 (1 x N.O. + 1 x N.C.)
Interlocking units (1) Pages 1.56...1.57	Electronic		VM3	TEF4-ON, TEF4-OFF
Connection kits Page 1.62	Mechanical			VM4
Surge suppressors Pages 1.52...1.53	Mechanical / Electrical	BSM6-30	BER16C-3	VEM4
	For reversing contactors	RV-BC6	RV5 (24...440 V)	BER16-4
	Varistor (AC/DC)		RC5-1 (24...440 V)	BER38-4
	RC type (AC)		RT5 (12...264 V)	
	Transil diode (DC)	RD7		

(1) See available reversing contactors VB6, VB7 and VAS09 ... VAS16

Overload relays – Chapter 2

Thermal relays	Class 10 (10A or 20 for TA42DU to TA80DU)	T16 (0.10...16 A)	T16 (0.10...16 A)	TF42 (0.10...38 A)
Electronic relays	Class 10E, 20E, 30E	E16DU (0.10...18.9 A)		EF19 (0.10...18.9 A) EF19 (0.10...18.9 A) EF45 (9...45 A)
Accessories for thermal overload relays	Wall/separate mounting kit	DB16 (T16 only), DB16E (E16DU only)		DB42 (TF42 only)

Manual motor starters – Chapter 4

	Thermal / magnetic protection	Class 10	MS116 for class 10A (0.16...32 A)	MS116 for class 10A (0.16...32 A)
		Class 20	MS132 (0.10...32 A)	MS132 (0.10...32 A)
	Magnetic only types			MO132 (0.10...32 A)
Accessories	For contactor mounting		BEA7/132	BEA16-3
	Auxiliary trip units, auxiliary contacts, busbars		HKF1, HK1, UA1, AA1, PS1, S1, SK1, CK1	BEA16-4
				BEA38-4
				HKF1, HK1, UA1, AA1, PS1, S1, SK1, CK1

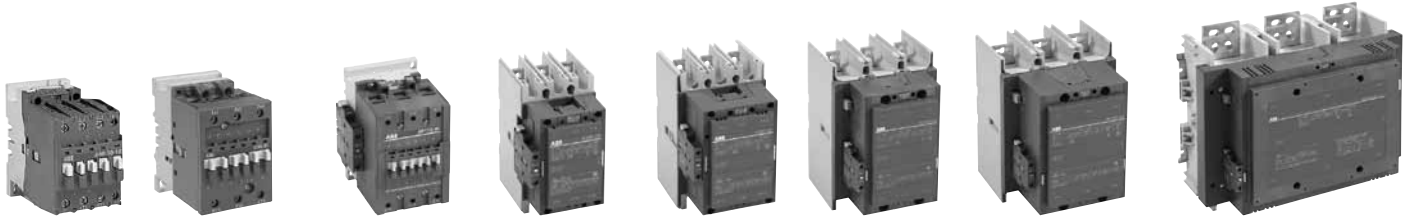

18.5	22	30	37	45	55	75	90	110	140	160	200	250	315	400	—	475	560	—
30	40	50	60	60	75	100	125	150	200	250	350	400	500	600	—	800	900	—
A40	A50	A63	A75	A95	A110	A145	A185	A210	A260	A300	AF400	AF460	AF580	AF750	AF1250	AF1350	AF1650	AF2050
AL40	AE50	AE63	AE75	AF95	AF110	AF145	AF185	AF210	AF260	AF300	AF400	AF460	AF580	AF750	AF1250	AF1350	AF1650	AF2050
—	AF50	AF63	AF75	AF95	AF110	AF145	AF185	AF210	AF260	AF300	AF400	AF460	AF580	AF750	AF1250	AF1350	AF1650	AF2050
37	50	65	75	96	110	145	185	210	260	305	400	460	580	750	—	860	1050	—
60	100	115	125	145	160	250	275	350	400	500	600	700	800	1050	1260	1350	1650	2050
60	80	90	105	125	150	230	250	300	350	400	550	650	750	900	1210	1350	1650	2100
—	2	—	3	—	—	4	—	—	5	—	—	6	—	7	—	—	8	—

AF Series - pages 1.14...1.15; A Series - pages 1.18...1.19; AE Series - pages 1.20...1.21;
AL Series - pages 1.22...1.23; NEMA rated contactors - pages 1.28...1.31

NEW!!
AF2650
General use: 2700A
AC-1: 2650A

CA5-10 (1 x N.O.), CA5-01 (1 x N.C.)			CAL18-11 (1 x N.O. + 1 x N.C.)					
CAL5-11 (1 x N.O. + 1 x N.C.)								
TEF5-ON, TEF5-OFF								
VM5-1	VE5-2		VM300H / VM300V		VM750H / VM750V		VM1650H	
VE5-1	VE5-2		VM300H / VM300V		VM750H / VM750V		VM1650H	
BER40V	BEM75-30	BEM110-30	BEM185-30	BEM300-30	BEM460-30	BEM750-30		
RV5 (24...440 V)								
RC5-1 (24...440 V)	RC5-2 (24...440 V)		RC5-3 (250...440V)					
RT5 (12...264 V)								

TA42DU (18...42 A)	TA75DU (18...80 A)	TA80DU (29...80 A) TA110DU (65...110 A)	TA200DU (66...200 A)	TA450DU/SU (130...310 A) class 30 for SU			
E45DU (9...45 A)	E80DU (27...80 A)	E140DU (50...140 A)	E200D-U (60...200 A)	E320DU (100...320 A)	E500DU (150...500 A)	E800DU (250...800 A)	E1250DU (375...1250 A)
DB80, DB45E, DB80E		DB80, DB200, D140E	DB200				

Circuit breakers – Chapter 17

MS450 (28...50 A)	MS495 (28...100 A)	Tmax Circuit breaker and accessories
MS451 (28...50 A)	MS496 (28...100 A)	
BEA40/450	BEA50/450, BEA75/495	
HK4, HKS4, UA4, AA4, PS4, S4, SK4		

4-pole contactors

Mini contactors



IEC	AC-1 Rated operational current	$\theta \leq 40^\circ\text{C}$, 690 V	A
UL/CSA	General use rating	600 V	A
	AC Control supply		Type
	DC Control supply		Type
	AC / DC Control supply		Type

16	20	
12 (300 V)	16	
B6	B7	
BC6	BC7	
—	—	
Page 1.34		

Control relays Chapter 6

Mini control relays - Chapter 6



IEC	AC-15 Rated operational current	400 V	A
UL/CSA	Pilot duty		
	AC Control supply		Type
	DC Control supply		Type
	AC / DC Control supply		Type

3		
A 600		
K6-22Z	K6-31Z	K6-40E
KC6-22Z	KC6-31Z	KC6-0E
—	—	—

Specialty contactors Pages 1.167...1.224

Bar contactors – Pages 1.215...1.224

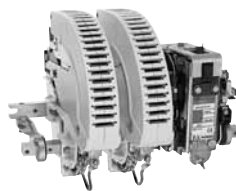

DC-1 Rated current up to 5000 A
DC-3/DC-5 Rated current up to 2000 A
1500 V with poles in series

IOR.. 63-...-CC to IOR.. 5100-...-CC

AC-1 Rated current up to 5000 A
AC-3 Rated power up to 1500 kW
(1520 A - 440 V)
IOR.. 63-...-MT to IOR.. 5100-...-MT

AC/DC Coupling: LOR.. contactors
Slip ring motor control: FOR .. contactors
Field discharge: AM(F)-CC-JORE contactors
AC/DC Switching (N.C./N.O. main poles):
NOR & JOR contactors
Latching contactors for energy saving and safety requirements: AMA or AME contactors

DC Circuit switching

Pages 1.207...1.214



100 A, 440 V, DC-1
GA75, GAE75 types
275...2050A, 1000V, DC-1
GAF185...GAF2050 types

Definite purpose

Pages 1.175...1.182



20...90 FLA
DP20...DP90 types

Contactors



	25	30	45	55	70	100	125	200	250	300	350	550	800	1000
	25	30	45	55	80	80	105	170	200	250	300	420	540	—
	AF09 AF09Z	AF16 AF16Z	AF26 AF26Z	AF38 AF38Z	A45	A50	A75	EK110	EK150	EK175	EK210	EK370	EK550	EK1000
	AF09 AF09Z	AF16 AF16Z	AF26 AF26Z	AF38 AF38Z	AE45	AE50	AE75	EK110	EK150	EK175	EK210	EK370	EK550	EK1000
	AF09 AF09Z	AF16 AF16Z	AF26 AF26Z	AF38 AF38Z	AF45	AF50	AF75	—	—	—	—	—	—	—

Page 1.32

Page 1.32...1.33

Page 1.32

Control relays - Chapter 6



3 A 600, Q 300			3 A 600, Q 600		
NS22E	NS31E	NS40E	NF22E	NF31E	NF40E
NSL22E	NSL31E	NSL40E	NF22E	NF31E	NF40E
—	—	—	NF22E	NF31E	NF40E

Lighting contactors – Pages 1.195...1.200



For tungsten and ballast loads up to 400 A.
Up to 12 poles, open and enclosed (UL Type 1)

Railway applications – Pages 1.201...1.206



Traction-specific (rail) devices with low-smoke plastic and ring-tongue termination

Capacitive switching

Pages 1.167...1.174



12.5 to 80 kvar
UA16..RA to UA110..RA types
UA16 to UA110 types

Dynamic braking / DC drive – Pages 1.185...1.194



2 DC-rated N.O. power poles
with optional 3rd N.C. pole for dynamic braking

Notes

1

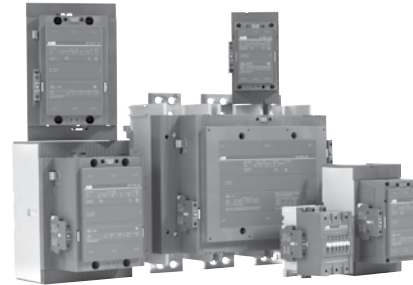

Across the line Contactors

AF series contactors (9...2650)

- 3- & 4-pole contactors
- General purpose up to 2700 A
- Motor applications up to 1150 hp, 900 kW
- NEMA Sizes 00...8
- DC switching up to 600V
- Electronic AC/DC coil input voltages
- PLC interface (AF400...AF2650)
- Wide variety of accessories
- Systems concept coupling units & bus kits
- Additional ratings including definite purpose, elevator duty & capacitive switching

AS / ASL contactors (9...16)

- 3-pole contactors
- For high-volume applications up to 10 hp
- Bulk packaging available
- AC or DC coil input voltages

A-line contactors (9...300)

- 3- & 4-pole contactors
- General purpose up to 400 A
- Motor applications up to 300 hp, 250 kW
- NEMA Sizes 00...5
- Additional ratings including definite purpose & elevator duty
- AC or DC coil input voltages

B / BC contactors

- 3 & 4 pole contactors
- Compact solutions up to 5 hp, 5.5 kW
- Quick-connect & PCB mount options
- AC or DC coil input voltages

EK contactors

- 4-pole contactors
- AC-1 up to 1000 A
- AC or DC coil input voltages

3-pole contactors

Standards & approvals	AF09(Z)... AF38(Z)	A/E/L9... A/E/L40	A/E/F50... A/E/F75	A/F95... A/F110	A/F145... AF750, AF1350, AF1650	AF1250, AF2050, AF2650	AS/L09... AS/L16	B/C6... B/C7
	E312527	E312527	E312527	E312527	E36588	E73397	E312527	E191658
		LR56745	LR56745					LR16332
	✓	✓	✓	✓	✓	✓	✓	✓
	✓	✓	✓	✓	✓	✓	✓	✓

Note: B/C6...7 quick-connect and PCB-mount are UL recognized.

4-pole contactors

Standards & approvals	AF09(Z)... AF38(Z)	A/E/L9... A/E/L26	A/E/F45... A/E/F75	EK110... EK550	EK1000	B/C6... B/C7
	E319322	E312527	E312527	E36588	-	E191658
		LR56745	LR56745		-	LR15332
	✓	✓	✓	✓	✓	✓
	✓	✓	✓	✓	✓	✓

Note: B/C6...7 quick-connect and PCB-mount are UL recognized.

General information

Technical terms and definitions

Altitude

Refers to the height of the site where the equipment is located, expressed in meters above the sea level.

Ambient temperature

Temperature of the air surrounding the unit.

Circuits

• Auxiliary circuit

All the conducting parts of a contactor, intended to be included in a circuit different from the main circuit and the control circuit of the contactor e.g. signalization, interlocking circuits etc ...

• Control circuit

All the conducting parts of a contactor (other than the main circuit) included in a circuit used for the closing operation, or opening operation, or both, of the contactor.

• Main circuit

All the conducting parts of a contactor included in the circuit which it is designed to close or open.

Coil operating range

Expressed as a multiple of the rated control circuit voltage U_c for the lower and upper limits.

Cycle duration

Total time of the on-load + off-load period.

Endurance / durability

• Electrical endurance

Number of on-load operating cycles (i.e. with current on the main contacts) a contactor can achieve, varies depending on the utilization category.

• Mechanical endurance

Number of off-load operating cycles (i.e. without current on the main contacts) a contactor can achieve.

Inching

Energizing a motor once or repeatedly for short periods to obtain small movements of the driven mechanism.

Insulation class according to the VDE 0110 and NFC 20-040

Characterizes contactors suitability in accordance with environment and utilization conditions. A contactor can be classified depending on its own clearance and creepage distances in the insulation classes A, B, C, D which correspond to different insulation voltage values.

The insulation class C is applicable to most of the industrial applications. Equipment described in this catalogue correspond to insulation class C.

Intermittent duty

Duty in which the main contacts of a contactor remain closed for periods of time insufficient to allow the contactor to reach thermal equilibrium, the current-carrying periods being separated by off-load periods of sufficient duration to restore equality of temperature with the cooling medium.

Mounting positions

Stated by the manufacturer. Please note restrictions when applicable.

On-load factor

Ratio of the current flow time to the total time of the cycle x 100.

Plugging

Stopping or reversing a motor quickly by interchanging two supply leads whilst the motor is running.

Rated breaking capacity; Rated making capacity

Value of r.m.s current a contactor can break or make at a fixed voltage value, within the conditions specified by the standards, depending on the utilization category.

Rated control circuit voltage U_c

Control voltage value for which the control circuit of the unit is sized.

Rated insulation voltage U_i

Voltage value which designates the unit and to which dielectric tests, clearance and creepage distances are referred.

Rated impulse withstand voltage U_{imp}

The highest peak value of an impulse voltage of prescribed form 1.2/50, which does not cause breakdown under specified conditions of test.

Rated operating current I_e

Current value stated by the manufacturer and taking into account the rated operating voltage U_e , the rated frequency, the rated duty, the utilization category, the electrical contact life and the type of the protective enclosure.

Rated operating voltage U_e

Voltage value to which utilization characteristics of the contactor are referred, i.e. phase to phase voltage in 3 phase circuits.

Conventional thermal current I_{th}

Value of current the contactor can withstand with poles in closed position, in free air for an eight hour duty, without the temperature rise of its various parts exceeding the limits specified by the standards.

Resistance to shocks

Requirements applicable for instance to vehicles, crane operation or switchgear slide-in module systems.

At the quoted permissible «g» values, contactors must not undergo a change in switching state and O/L relays must not trip.

Resistance to vibrations

Requirements applicable to all the vehicles, vessels and other similar transport systems. At the quoted amplitude and vibration frequency values, the unit must be capable to achieve the required duty.

Short-circuit protection coordination

Achieved by using back-up protection devices such as circuit-breakers, H.R.C. fuses or standard fuses.

Co-ordination types a, b, c are defined in IEC 292-1 publication, VDE 0660, NFC 63-650 standards. Co-ordination types "1" and "2" are defined in IEC 947-4-1.

• Type 1 co-ordination

There has been no discharge of parts beyond the enclosure. Damage to the contactor and the overload relay is acceptable.

• Type 2 co-ordination

No damage to the overload relay or other parts has occurred, except that welding of contactor or starter contacts is permitted, if they are easily separated.

Switching frequency

Number of operating cycles per hour.

Time

• Closing time

Time between energization of the coil until the moment the contacts of the first current path to be closed actually close.

• Opening time

Time from the beginning of state causing breaking until the moment when the contacts of the last current path to be opened are open.

• Minimal operation time

Shortest control duration to ensure complete closing or opening of a contactor.

• Short time current permissible

Value of current which the contactor can withstand in closed position for a short time period and within specified conditions.

• Time constant

Ratio of inductance to the resistance : $L/R = \text{mH}/\text{Ohm} = \text{ms}$.

General information

IEC Standards, utilization categories

Standards

- IEC standards 158-1: "Contactors" and series IEC 292 :

"Motor-starters" have been revised and replaced by the new IEC 947-4-1 (1990-05): "Contactors and Motor-starters" referring to IEC 947-1 (1988): "General rules" The new standards will constitute the basis of the future European and National standards, not yet revised.

Therefore the ratings indicated in this catalog are established according to the former and the future standards.

- Main changes and additions in the new standards are:
- Revision and extension of the utilization categories (see hereafter)
- Replacement of the coordination classes types a, b, c by new types: "1" (approximately equivalent to former class "a") and "2" (approximately equivalent to former class "c") with additional requirements.
- Classification of the thermal overload relays in tripping classes: 10 A; 10; 20 and 30 depending on their tripping times, at 1.5 and 7.2 times their setting current, in order to cover motor applications depending on their starting times. Class 10 A is adapted for motors according to IEC 34-1.
- Introduction of tests to verify the connecting capability and the mechanical strength of terminals.

Utilization categories

A contactor duty is characterized by the utilization category plus indication of the rated operating voltage and the rated operating current (see at Rated ...), or the motor characteristics.

Utilization categories for contactors according to IEC 947-4-1

Alternating current:	AC-1	Non-inductive or slightly inductive loads, resistance furnaces. Power factor 0.7 - 0.8 (slightly inductive).
	AC-2	Slip-ring motors: starting, switching-off.
	AC-3	Squirrel-cage motors: starting, switching-off motors during running. Power factor 0.4 - 0.5 (AC-3).
	AC-4	Squirrel-cage motors: starting, plugging, inching.
	AC-5a	Switching of electric discharge lamp controls.
	AC-5b	Switching of incandescent lamps.
	AC-6a	Switching of transformers.
	AC-6b	Switching of capacitor banks
	AC-8a AC-8b	Hermetic refrigerant compressor motor control with manual resetting of overload releases Hermetic refrigerant compressor motor control with automatic resetting of overload releases.
Direct current:	DC-1	Non-inductive or slightly inductive loads, resistance furnaces.
	DC-3	Shunt motors: starting, plugging, inching. Dynamic breaking of d.c. motors.
	DC-5	Series motors: starting, plugging, inching. Dynamic breaking of d.c. motors.
	DC-6	Switching of incandescent lamps

Utilization categories for contactor relays according to IEC 947-5-1

Alternating current:	AC-12	Control of resistive loads and solid state loads with isolation by opto couplers.
	AC-13	Control of solid state loads with transformer isolation.
	AC-14	Control of small electromagnetic loads (≤ 72 VA).
	AC-15	Control of electromagnetic loads (> 72 VA).
Direct current:	DC-12	Control of resistive loads and solid state loads with isolation by opto couplers.
	DC-13	Control of electromagnets.
	DC-14	Control of electromagnetic loads having economy resistors in circuit.

Utilization categories AC-1, AC-2, AC-3, AC-4 and DC-1, DC-3, DC-5 are maintained with slightly more severe tests.

Other categories have been added in order to standardize specific applications. In fact some contactor applications and the specific criteria characterizing the types of load controlled can modify the recommended utilization characteristics. These major applications are, for example :

Switching of capacitor banks

This application is characterized by high current peaks when switching-on the contactor and presence of harmonic currents on uninterrupted duty. For this application, IEC 947-4-1 has defined an utilization category AC-6b. Practical ratings have to be defined according to tests or, in absence of tests, by a calculation indicated in IEC 947-4-1.

Switching of transformers

This application is characterized by high current peaks on contactor closing due to magnetization phenomena. The corresponding utilization category according to IEC 947-4-1 is AC-6a. Ratings are derived from test-values for AC-3 or AC-4 according to formula given in IEC 947-4-1.

Switching of lighting circuits

The current peaks on contactor closing and power factor vary depending on the type of lamps, the switching method used and if compensation systems are fitted or not.

IEC 947-4-1 contains two standard utilization categories

- AC-5a for switching of the electric discharge lamps.
- AC-5b for switching of incandescent lamp.

General information

Motor ratings

Horsepower to full-load Amperes for AC induction motors

Horsepower (hp)	Full Load Amperes (FLA)													
	110...120 v ac		200 v ac		208 v ac		220...240 v ac		380...415 v ac		440...480 v ac		550...600 v ac	
	Single phase	Three phase	Single phase	Three phase	Single phase	Three phase	Single phase	Three phase	Single phase	Three phase	Single phase	Three phase	Single phase	Three phase
1/10	3.0	-	-	-	-	-	1.5	-	1.0	-	-	-	-	-
1/8	3.8	-	-	-	-	-	1.9	-	1.2	-	-	-	-	-
1/6	4.4	-	2.5	-	2.4	-	2.2	-	1.4	-	-	-	-	-
1/4	5.8	-	3.3	-	3.2	-	2.9	-	1.8	-	-	-	-	-
1/3	7.2	-	4.1	-	4.0	-	3.6	-	2.3	-	-	-	-	-
1/2	9.8	4.4	5.6	2.5	5.4	2.4	4.9	2.2	3.2	1.3	2.5	1.1	2.0	0.9
3/4	13.8	6.4	7.9	3.7	7.6	3.5	6.9	3.2	4.5	1.8	3.5	1.6	2.8	1.3
1	16.0	8.4	9.2	4.8	8.8	4.6	8.0	4.2	5.1	2.3	4.0	2.1	3.2	1.7
1-1/2	20.0	12.0	11.5	6.9	11.0	6.6	10.0	6.0	6.4	3.3	5.0	3.0	4.0	2.4
2	24.0	13.6	13.8	7.8	13.2	7.5	12.0	6.8	7.7	4.3	6.0	3.4	4.8	2.7
3	34.0	19.2	19.6	11.0	18.7	10.6	17.0	9.6	10.9	6.1	8.5	4.8	6.8	3.9
5	56.0	30.4	32.2	17.5	30.8	16.7	28.0	15.2	17.9	9.7	14.0	7.6	11.2	6.1
7-1/2	80.0	44.0	45.0	25.3	44.0	24.2	40.0	22.0	27.0	14.0	21.0	11.0	16.0	9.0
10	100.0	56.0	57.5	32.2	55.0	30.8	50.0	28.0	33.0	18.0	26.0	14.0	20.0	11.0
15	135.0	84.0	-	48.3	-	46.2	68.0	42.0	44.0	27.0	34.0	21.0	27.0	17.0
20	-	108.0	-	62.1	-	59.4	88.0	54.0	56.0	34.0	44.0	27.0	35.0	22.0
25	-	136.0	-	78.2	-	74.8	110.0	68.0	70.0	44.0	55.0	34.0	44.0	27.0
30	-	160.0	-	92.0	-	88.0	136.0	80.0	87.0	51.0	68.0	40.0	54.0	32.0
40	-	208.0	-	120.0	-	114.0	176.0	104.0	112.0	66.0	88.0	52.0	70.0	41.0
50	-	260.0	-	150.0	-	143.0	216.0	130.0	139.0	83.0	108.0	65.0	86.0	52.0
60	-	-	-	177.0	-	169.0	-	154.0	-	103.0	-	77.0	-	62.0
75	-	-	-	221.0	-	211.0	-	192.0	-	128.0	-	96.0	-	77.0
100	-	-	-	285.0	-	273.0	-	248.0	-	165.0	-	124.0	-	99.0
125	-	-	-	359.0	-	343.0	-	312.0	-	208.0	-	156.0	-	125.0
150	-	-	-	414.0	-	396.0	-	360.0	-	240.0	-	180.0	-	144.0
200	-	-	-	552.0	-	528.0	-	480.0	-	320.0	-	240.0	-	192.0
250	-	-	-	-	-	-	-	604.0	-	403.0	-	302.0	-	242.0
300	-	-	-	-	-	-	-	722.0	-	482.0	-	361.0	-	289.0
350	-	-	-	-	-	-	-	828.0	-	560.0	-	414.0	-	336.0
400	-	-	-	-	-	-	-	954.0	-	636.0	-	477.0	-	382.0
450	-	-	-	-	-	-	-	1030.0	-	-	-	515.0	-	412.0
500	-	-	-	-	-	-	-	1180.0	-	786.0	-	590.0	-	472.0

Full-load motor-running currents in Amperes corresponding to various AC horsepower ratings as published in Table 50.1 of UL 508.

General information

Pilot duty ratings and overload trip classes

Pilot duty ratings for AC control circuit contacts

Contact rating designation	Continuous thermal, test current (A)	Maximum current, 50/60 Hz (A)									
		120 v ac		240 v ac		480 v ac		600 v ac		Volt-amperes	
		Make	Break	Make	Break	Make	Break	Make	Break	Make	Break
A150	10	60	6.00	-	-	-	-	-	-	7200	720
A300	10	60	6.00	30	3.00	-	-	-	-	7200	720
A600	10	60	6.00	30	3.00	15	1.50	12	1.20	7200	720
B150	5	30	3.00	-	-	-	-	-	-	3600	360
B300	5	30	3.00	15	1.50	-	-	-	-	3600	360
B600	5	30	3.00	15	1.50	7.5	0.75	6	0.60	3600	360
C150	2.5	15	1.5	-	-	-	-	-	-	1800	180
C300	2.5	15	1.5	7.5	0.75	-	-	-	-	1800	180
C600	2.5	15	1.5	7.5	0.75	3.75	0.375	3.00	0.30	1800	180
D150	1.0	3.60	0.60	-	-	-	-	-	-	432	72
D300	1.0	3.60	0.60	1.80	0.30	-	-	-	-	432	72
E150	0.5	1.80	0.30	-	-	-	-	-	-	216	36

Mechanical switching ratings and test values as published in Table 1-4-1 of NEMA ICS 5-2000 (R2005, R2010)

Pilot duty ratings for DC control circuit contacts

Contact rating designation	Continuous thermal, test current (A)	Maximum current, 50/60 Hz (A)			
		120 v dc	250 v dc	301 to 600 v dc	Volt-amperes
		Make / Break	Make / Break	Make / Break	Make / Break
N150	10	2.2	-	-	275
N300	10	2.2	1.1	-	275
N600	10	2.2	1.1	0.40	275
P150	5.0	1.1	-	-	138
P300	5.0	1.1	0.55	-	138
P600	5.0	1.1	0.55	0.20	138
Q150	2.5	0.55	-	-	69
Q300	2.5	0.55	0.27	-	69
Q600	2.5	0.55	0.27	0.10	69
R150	1.0	0.22	-	-	28
R300	1.0	0.22	0.11	-	28

Mechanical switching ratings and test values as published in Table 1-4-1 of NEMA ICS 5-2000 (R2005, R2010)

Overload trip classes

Trip class	Tripping time T_p (seconds)
10A	$2 < T_p \leq 10$
10	$4 < T_p \leq 10$
20	$6 < T_p \leq 20$
30	$9 < T_p \leq 30$

Trip classes as published in Table 2 of UL 60947-4-1A.

Pilot duty rating explanation

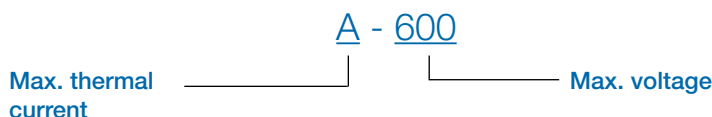

General information

AF Series contactors

AF09 - AF110

Application

AF series contactors (9...110) are primarily used for controlling single and three phase motors and switching power circuits up to 600V AC, 240V DC

Description

AF series contactors are provided in either three or four power pole configurations with a variety of accessories including auxiliary contacts, close coupling adaptors, interlocks, and busbars.

Control circuit types

AF series contactor coils are designed to utilize both AC (50/60 Hz) and DC control circuit inputs ranging from 12...500V. Surge suppression is included.

Contactors types

3 NO pole:	AF09...AF110
4 NO pole:	AF09...AF75
2 NO / 2 NC pole:	AF09...AF75

Mounting hole pattern identical from AF09...AF38. Only three different patterns for contactors AF09...AF110

Quick DIN-rail mount & dismount (no tools required AF09...AF38)

- 35 x 7.5mm for AF09...AF38
- 35 x 15mm for AF09...AF75
- 75mm for AF45...AF110

Integral surge suppression AF09...AF110

Actuator for side-mount accessories

Mechanical interlocks with no additional width for AF09...AF38

Contoured sides for easy access to panel mounting holes

Terminals on AF09...AF110 contactors are delivered in open position with captive screws (screws of unused terminals must be tightened)

IP20 degree protection according to IEC/EN 60947-1; protection from live parts according to VDE0106 Part. 100.

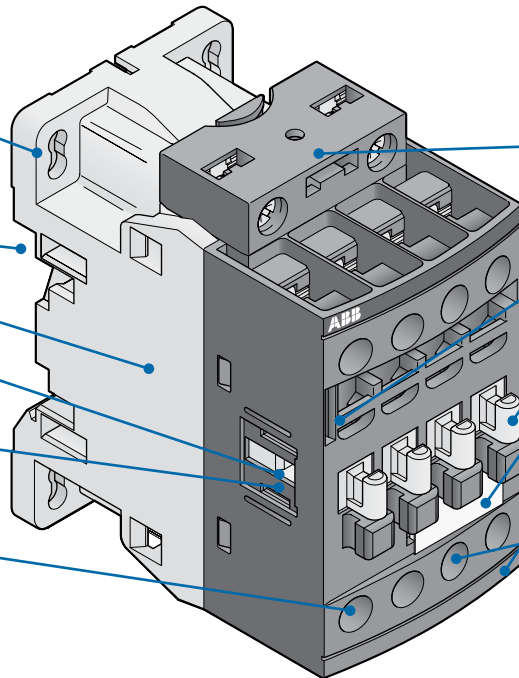

Detachable coil terminals (AF09...AF38)

- Can be pre-wired prior to installation
- Can easily be rotated from top (standard) to bottom

Front-mount coil termination available

Stops for attaching front-mount accessories

Function markers included as standard on AF09...AF38; available as accessory AF50...AF110

Clear indication of coil voltages and frequencies

Terminal screws:

- Posidrive (+,-) No 2 AF09...AF75
- M8 hex threaded socket screw for AF95...AF110

Catalog number explanation

For reference only – not all combinations will produce valid catalog numbers

AF09 - 30 - 10 - 13

Contactors series & frame size

Power pole configuration

- 30 = 3 NO
- 40 = 4 NO
- 22 = 2 NO / 2 NC

Coil voltage code

(see product selection pages)

Auxiliary pole configuration

- 00 - No auxiliary provided
- 10 = 1 NO
- 01 = 1 NC
- 11 = 1 NO / 1 NC
- 22 = 2 NO / 2 NC

General information

AF Series contactors

AF145 - AF2650

Application

AF series contactors (145...2650) are primarily used for controlling single and three phase motors and switching power circuits up to 1000V AC, 600V DC.

Description

AF series contactors are provided in a three power pole configuration with a variety of accessories including auxiliary contacts, close coupling adaptors, interlocks, and busbars.

Control circuit types

AF series contactor coils are designed to utilize both AC (50/60 Hz) and DC control circuit inputs ranging from 24...500V. Surge suppression is included.

Contactors types

3 NO pole: AF145...AF2650

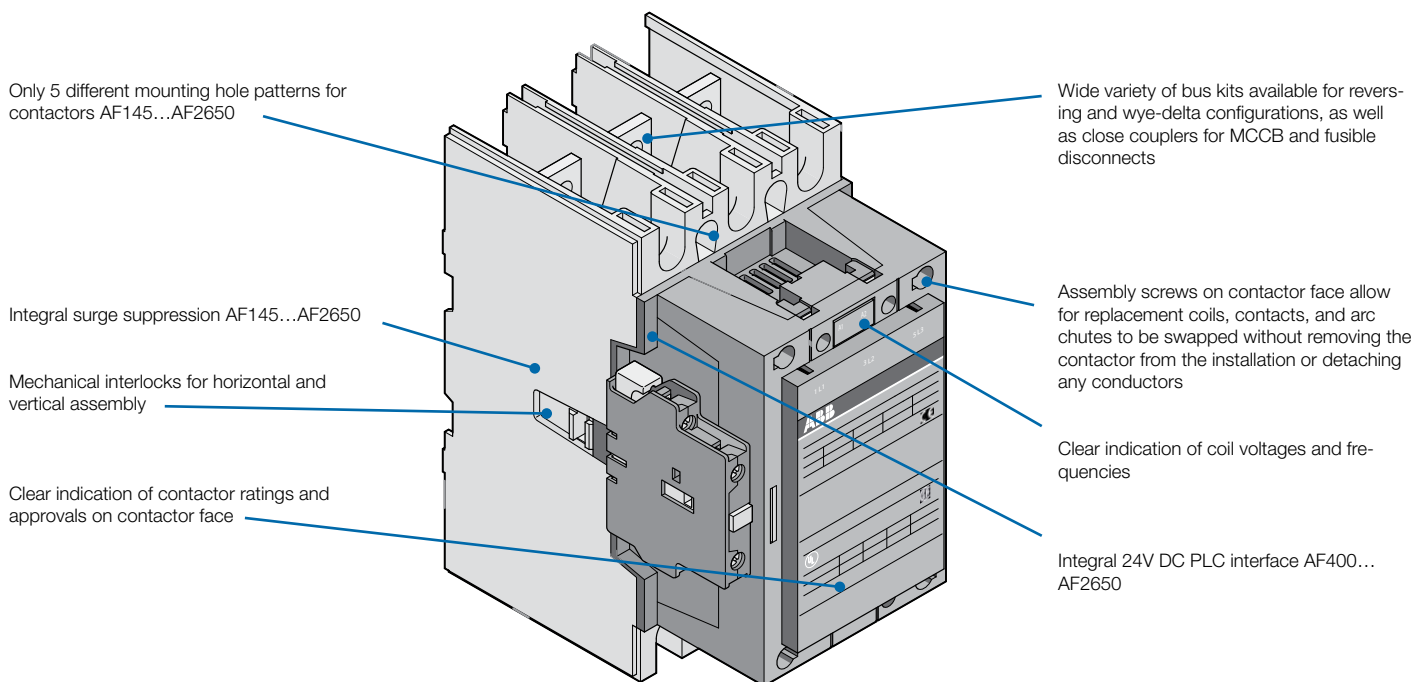

Catalog number explanation

For reference only – not all combinations will produce valid catalog numbers

AF2650 - 30 - 11 - 70

Contactors series & frame size

Power pole configuration

- 30 = 3 NO

Coil voltage code

(see product selection pages)

Auxiliary pole configuration

- 00 - No auxiliary provided
- 11 = 1 NO / 1 NC
- 22 = 2 NO / 2 NC

AF non-reversing, 3-pole

For applications up to 1150 hp, 900 kW
Electronic AC/DC operated coils



AF09...AF16



AF95...AF110



AF210...AF300

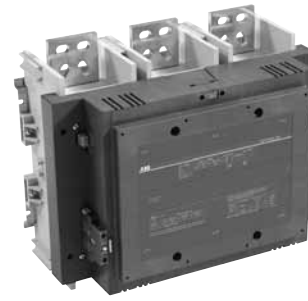

AF1350...AF2650

Electrical ratings ①

IEC/EN 60947-4-1					UL 508, 60947-4-1A CSA C22.2 No.14, 60947-4-1-07		UL SP c US		Non-reversing		Standard auxiliary contacts ③		Catalog number
Rated operational current I _e , AC-1, AC-3 (A)		Rated operational power P _e , AC-3, 55°C (kW) ②			AC general purpose ratings (A)	Maximum motor switching current (A)	AC motor ratings, breaking all lines, three phase, 50/60 Hz (hp)				NO	NC	
AC-1 40°C	AC-3 55°C ②	220... 240V	380... 400V	690V	600V		200... 208V	220... 240V	440... 480V	550... 600V			
25	9	2.2	4	5.5	25	9	2	2	5	7.5	1	-	AF09-30-10-Δ
											-	1	AF09-30-01-Δ
28	12	3	5.5	7.5	28	11	3	3	7.5	10	1	-	AF12-30-10-Δ
											-	1	AF12-30-01-Δ
30	18	4	7.5	9	30	17	5	5	10	15	1	-	AF16-30-10-Δ
											-	1	AF16-30-01-Δ
45	26	6.5	11	15	45	24.2	7.5	7.5	15	20	-	-	AF26-30-00-Δ
50	32	9	15	18.5	50	30.8	10	10	20	25	-	-	AF30-30-00-Δ
50	38	11	18.5	22	50	-	-	-	-	-	-	-	AF38-30-00-Δ
100	50	15	22	30	80	54	15	20	40	50	1	1	AF50-30-11-Δ
115	65	18.5	30	37	90	68	20	25	50	60	1	1	AF63-30-11-Δ
125	75	22	37	40	105	80	25	30	60	75	1	1	AF75-30-11-Δ
145	96	25	45	55	150	88	30	30	60	75	1	1	AF95-30-11-Δ
160	110	30	55	75	150	104	30	40	75	100	1	1	AF110-30-11-Δ
250	145	45	75	110	230	130	40	50	100	125	1	1	AF145-30-11-Δ
275	185	55	90	132	250	156	50	60	125	150	1	1	AF185-30-11-Δ
350	210	59	110	160	300	192	60	75	150	200	1	1	AF210-30-11-Δ
400	260	80	140	200	350	248	75	100	200	250	1	1	AF260-30-11-Δ
500	305	90	160	250	400	302	100	100	250	300	1	1	AF300-30-11-Δ
600	400	110	200	315	550	414	125	150	350	400	1	1	AF400-30-11-Δ
700	460	132	250	355	650	480	150	200	400	500	1	1	AF460-30-11-Δ
800	580	160	315	500	750	604	250	250	500	600	1	1	AF580-30-11-Δ
1050	750	220	400	600	900	722	250	300	600	700	1	1	AF750-30-11-Δ
1260	-	-	-	-	1210	-	-	-	-	-	1	1	AF1250-30-11-Δ
1350	860	257	475	750	1350	954	-	400	800	1000	1	1	AF1350-30-11-Δ
1650	1050	315	560	900	1650	1050	-	450	900	1150	1	1	AF1650-30-11-Δ
2050	-	-	-	-	2100	-	-	-	-	-	1	1	AF2050-30-11-Δ
2650	-	-	-	-	2700	-	-	-	-	-	1	1	AF2650-30-11-Δ

Coil voltage selection chart (Δ)

Rated control circuit voltage U _c ④	AF09... AF38	AF50... AF300	AF400... AF750	AF1250	AF1350... AF2650
20...60V DC	11	72	-	-	-
24...60V AC	11	-	-	-	-
24...60V DC	-	-	68	68	-
48...130V AC/DC	12	69	69	69	-
100...250V AC/DC	13	70	70	70	70
250...500V AC/DC	14	-	71	-	-

Example(s):
24V DC input voltage: AF16-30-10-11
120V AC input voltage: AF300-30-11-10

Control inputs

AF400...AF2650 are equipped with integral low voltage inputs, allowing for direct PLC control:

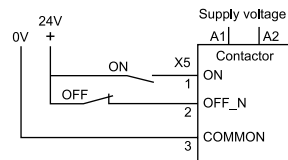

① For selection purposes; for complete electrical ratings, see Technical Data.
② AF09... AF38 at 60°C.
③ Auxiliary contacts integral for AF09...AF16; all others side-mount.
④ AC coil input voltage(s) at 50/60 Hz unless specified.

AF mechanically interlocked, reversing, 3-pole

For applications up to 700 hp, 600 kW
Electronic AC/DC operated coils

Across the line
Contactors 1

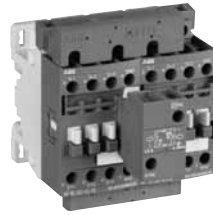

AF09R...AF16R

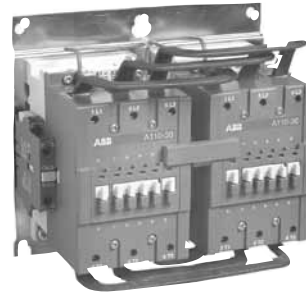

AF95R...AF110R

Electrical ratings ①②

UL 508, 60947-4-1A
CSA C22.2 No.14, 60947-4-1-07



AC general purpose ratings (A)	Maximum motor switching current (A)	AC motor ratings, breaking all lines, three phase, 50/60 Hz (hp)				Mechanically interlocked		Catalog number ③	Reversing		Catalog number ③
		200... 208V	220... 240V	440... 480V	550... 600V	NO	NC		NO	NC	
25	9	2	2	5	7.5	2	2	AF09M-30-22-Δ	2	2	AF09R-30-22-Δ
-	-	-	-	-	-	-	-	-	-	-	-
28	11	3	3	7.5	10	2	2	AF12M-30-22-Δ	2	2	AF12R-30-22-Δ
-	-	-	-	-	-	-	-	-	-	-	-
30	17	5	5	10	15	2	2	AF16M-30-22-Δ	2	2	AF16R-30-22-Δ
-	-	-	-	-	-	-	-	-	-	-	-
45	24.2	7.5	7.5	15	20	-	2	AF26M-30-02-Δ	-	2	AF26R-30-02-Δ
50	30.8	10	10	20	25	-	2	AF30M-30-02-Δ	-	2	AF30R-30-02-Δ
-	-	-	-	-	-	-	-	-	-	-	-
80	54	15	20	40	50	2	2	AF50M-30-11-Δ	2	2	AF50R-30-11-Δ
90	68	20	25	50	60	2	2	AF63M-30-11-Δ	2	2	AF63R-30-11-Δ
105	80	25	30	60	75	2	2	AF75M-30-11-Δ	2	2	AF75R-30-11-Δ
150	88	30	30	60	75	2	2	AF95M-30-11-Δ	2	2	AF95R-30-11-Δ
150	104	30	40	75	100	2	2	AF110M-30-11-Δ	2	2	AF110R-30-11-Δ
230	130	40	50	100	125	2	2	AF145M-30-11-Δ	2	2	AF145R-30-11-Δ
250	156	50	60	125	150	2	2	AF185M-30-11-Δ	2	2	AF185R-30-11-Δ
300	192	60	75	150	200	2	2	AF210M-30-11-Δ	2	2	AF210R-30-11-Δ
350	248	75	100	200	250	2	2	AF260M-30-11-Δ	2	2	AF260R-30-11-Δ
400	302	100	100	250	300	2	2	AF300M-30-11-Δ	2	2	AF300R-30-11-Δ
550	414	125	150	350	400	2	2	AF400M-30-11-Δ	2	2	AF400R-30-11-Δ
650	480	150	200	400	500	2	2	AF460M-30-11-Δ	2	2	AF460R-30-11-Δ
750	604	250	250	500	600	2	2	AF580M-30-11-Δ	2	2	AF580R-30-11-Δ
900	722	250	300	600	700	2	2	AF750M-30-11-Δ	2	2	AF750R-30-11-Δ
-	-	-	-	-	-	-	-	-	-	-	-
-	-	-	-	-	-	-	-	-	-	-	-
-	-	-	-	-	-	-	-	-	-	-	-
-	-	-	-	-	-	-	-	-	-	-	-
-	-	-	-	-	-	-	-	-	-	-	-

Coil voltage selection chart (Δ)

Rated control circuit voltage U _c ④	AF09...AF30	AF50...AF300	AF400...AF750
20...60V DC	11	72	-
24...60V AC	11	-	-
24...60V DC	-	-	68
48...130V AC/DC	12	69	69
100...250V AC/DC	13	70	70
250...500V AC/DC	14	-	71

Example(s):

24V DC input voltage: AF16M-30-22-11

120V AC input voltage: AF300R-30-11-70

Reversing vs. mechanically interlocked

Full voltage reversing contactors are pre-assembled using two (2) contactors, a mechanical interlock, an electrical interlock, and reversing busbars. Mechanically interlocked contactors are offered less the reversing bus.

① For selection purposes; for complete electrical ratings, see Technical Data.

② For ratings according to IEC/EN 60947-4-1, refer to AF non-reversing selection table or Technical Data.

③ AF09R(M)...AF30R(M) assembled using connection clips, AF50R(M)...AF750R(M) mounted on common baseplate.

④ AC coil input voltage(s) at 50/60 Hz unless specified.

AFZ non-reversing, 3-pole

For applications up to 25 hp, 22 kW
Low power consumption, electronic AC/DC operated coils



AF09Z... AF16Z



AF26Z... AF38Z

Electrical ratings ①

IEC/EN 60947-4-1					UL 508, 60947-4-1A CSA C22.2 No.14, 60947-4-1-07							Non-reversing		Catalog number
Rated operational current I _e AC-1, AC-3 (A)		Rated operational power P _e , AC-3, 60°C (kW)			AC general purpose ratings (A)	Maximum motor switching current (A)	AC motor ratings, breaking all lines, three phase, 50/60 Hz (hp)				Standard auxiliary contacts ②			
AC-1, 40°C	AC-3, 60°C	220... 240V	380... 400V	690V	600V		200... 208V	220... 240V	440... 480V	550... 600V	NO	NC		
25	9	2.2	4	5.5	25	9	2	2	5	7.5	1	-	AF09Z-30-10-Δ	
											-	1	AF09Z-30-01-Δ	
28	12	3	5.5	7.5	28	11	3	3	7.5	10	1	-	AF12Z-30-10-Δ	
											-	1	AF12Z-30-01-Δ	
30	18	4	7.5	9	30	17	5	5	10	15	1	-	AF16Z-30-10-Δ	
											-	1	AF16Z-30-01-Δ	
45	26	6.5	11	15	45	24.2	7.5	7.5	15	20	-	-	AF26Z-30-00-Δ	
50	32	9	15	18.5	50	30.8	10	10	20	25	-	-	AF30Z-30-00-Δ	
50	38	11	18.5	22	50	-	-	-	-	-	-	-	AF38Z-30-00-Δ	

Coil voltage selection chart (Δ)

Rated control circuit voltage U _c ③	AF09Z... AF38Z
12...20V DC	20
24...60V AC	21
20...60V DC	21
48...130V AC/DC	22
100...250V AC/DC	23

Example(s):
24V DC input voltage: AF16Z-30-10-21
120V AC input voltage: AF30Z-30-00-23

① For selection purposes, for complete electrical ratings, see Technical Data

② Auxiliary contacts integral for AF09Z... AF16Z

③ AC coil input voltage(s) at 50/60 Hz unless specified.

AFZ mechanically interlocked, reversing, 3-pole

For applications up to 25 hp, 18.5 kW
Low power consumption, electronic AC/DC operated coils

Across the line
Contactors

1

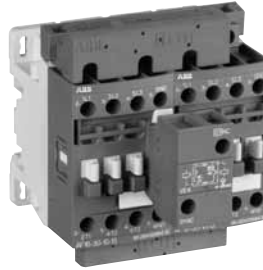

AF09ZR... AF16ZR

Electrical ratings ①②

UL 508, 60947-4-1A
CSA C22.2 No. 14, 60947-4-1-07

AC general purpose ratings (A)	Maximum motor switching current (A)	AC motor ratings, breaking all lines, three phase, 50/60 Hz (hp)				Mechanically interlocked		Catalog number ③	Reversing		Catalog number ③
		200... 208V	220... 240V	440... 480V	550... 600V	Standard auxiliary contacts	Standard auxiliary contacts				
600V						NO	NC		NO	NC	
25	9	2	2	5	7.5	2	2	AF09MZ-30-22-Δ	2	2	AF09RZ-30-22-Δ
-	-	-	-	-	-	-	-	-	-	-	-
28	11	3	3	7.5	10	2	2	AF12MZ-30-22-Δ	2	2	AF12RZ-30-22-Δ
-	-	-	-	-	-	-	-	-	-	-	-
30	17	5	5	10	15	2	2	AF16MZ-30-22-Δ	2	2	AF16RZ-30-22-Δ
-	-	-	-	-	-	-	-	-	-	-	-
45	24.2	7.5	7.5	15	20	-	2	AF26MZ-30-02-Δ	-	2	AF26RZ-30-02-Δ
50	30.8	10	10	20	25	-	2	AF30MZ-30-02-Δ	-	2	AF30RZ-30-02-Δ
-	-	-	-	-	-	-	-	-	-	-	-

Coil voltage selection chart (Δ)

Rated control circuit voltage U _c ④	AF09Z... AF38Z
12...20V DC	20
24...60V AC	21
20...60V DC	21
48...130V AC/DC	22
100...250V AC/DC	23

Example(s):
24V DC input voltage: AF16ZM-30-22-21
120V AC input voltage: AF30ZR-30-02-23

Reversing vs. mechanically interlocked

Full voltage reversing contactors are pre-assembled using two (2) contactors, a mechanical interlock, an electrical interlock, and reversing busbars. Mechanically interlocked contactors are offered less the reversing bus.

① For selection purposes, for complete electrical ratings, see Technical Data
② For ratings according to IEC/EN 60947-4-1, refer to AFZ non-reversing selection table or Technical Data.
③ AF09ZR(M)...AF30ZR(M) assembled using connection clips.
④ AC coil input voltage(s) at 50/60 Hz unless specified.

A non-reversing, 3-pole

For applications up to 300 hp, 250 kW
AC operated coils



A30... A40



A50... A75



A145... A185

Electrical ratings ①

IEC/EN 60947-4-1					UL 508, 60947-4-1A CSA C22.2 No.14, 60947-4-1-07							Non-reversing		Catalog number
Rated operational current I _e AC-1, AC-3 (A)		Rated operational power P _e , AC-3, 55°C (kW)			AC general purpose ratings (A)	Maximum motor switching current (A)	AC motor ratings, breaking all lines, three phase, 50/60 Hz (hp)				Standard auxiliary contacts ②			
AC-1, 40°C	AC-3, 55°C	220... 240V	380... 400V	690V	600V		200... 208V	220... 240V	440... 480V	550... 600V	NO	NC		
25	9	2.2	4	5.5	21	9	2	2	5	7.5	1	-	▼A9-30-10-Δ	
											-	1	▼A9-30-01-Δ	
27	12	3	5.5	7.5	25	11	3	3	7.5	10	1	-	▼A12-30-10-Δ	
											-	1	▼A12-30-01-Δ	
30	17	4	7.5	9	30	17	5	5	10	15	1	-	▼A16-30-10-Δ	
											-	1	▼A16-30-01-Δ	
45	26	6.5	11	15	40	28	7.5	10	20	25	1	-	▼A26-30-10-Δ	
											-	1	▼A26-30-01-Δ	
55	32	9	15	18.5	50	34	10	10	25	30	1	-	A30-30-10-Δ	
											-	1	A30-30-01-Δ	
60	37	11	18.5	22	60	42	10	15	30	40	1	-	A40-30-10-Δ	
											-	1	A40-30-01-Δ	
100	50	15	22	30	80	54	15	20	40	50	1	1	A50-30-11-Δ	
115	65	18.5	30	37	90	68	20	25	50	60	1	1	A63-30-11-Δ	
125	75	22	37	40	105	80	25	30	60	75	1	1	A75-30-11-Δ	
145	96	25	45	55	150	88	30	30	60	75	1	1	A95-30-11-Δ	
160	110	30	55	75	150	104	30	40	75	100	1	1	A110-30-11-Δ	
250	145	45	75	110	230	130	40	50	100	125	1	1	A145-30-11-Δ	
275	185	55	90	132	250	156	50	60	125	150	1	1	A185-30-11-Δ	
350	210	59	110	160	300	192	60	75	150	200	1	1	A210-30-11-Δ	
400	260	80	140	200	350	248	75	100	200	250	1	1	A260-30-11-Δ	
500	305	90	160	250	400	302	100	100	250	300	1	1	A300-30-11-Δ	

▼ Planned legacy product; recommend AF series contactors.

Coil voltage selection chart (Δ)

Rated control circuit voltage U _c ③	A9...A300
24V AC	81
48V AC	83
110...120V AC, 60 Hz	84
230...240V AC, 60 Hz	80
480V AC, 60 Hz	51
600V AC, 60 Hz	55

Example(s):

24V AC input voltage: A16-30-10-81

120V AC input voltage: A300-30-11-84

① For selection purposes, for complete electrical ratings, see Technical Data

② Auxiliary contacts integral for A9... A40

③ AC coil input voltage(s) at 50/60 Hz unless specified. For additional coil voltages, see page 1.35.

A mechanically interlocked, reversing, 3-pole For applications up to 300 hp, 250 kW AC operated coils

Across the line
1
Contactors

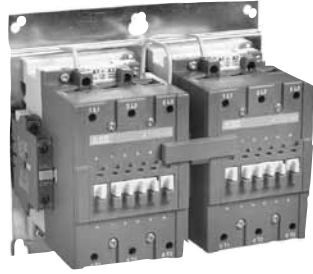

A95M... A110M

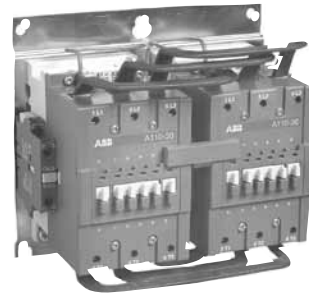

A95R... A110R

Electrical ratings ①②

UL 508, 60947-4-1A
CSA C22.2 No.14, 60947-4-1-07



AC general purpose ratings (A)	Maximum motor switching current (A)	AC motor ratings, breaking all lines, three phase, 50/60 Hz (hp)				Standard auxiliary contacts		Catalog number ③	Reversing		Catalog number ③
		200... 208V	220... 240V	440... 480V	550... 600V	NO	NC		Standard auxiliary contacts	NO	
600V											
21	9	2	2	5	7.5	2	2	▼A9M-30-10-Δ	2	2	▼A9R-30-10-Δ
-	-	-	-	-	-	-	-	-	-	-	-
25	11	3	3	7.5	10	2	2	▼A12M-30-10-Δ	2	2	▼A12R-30-10-Δ
-	-	-	-	-	-	-	-	-	-	-	-
30	17	5	5	10	15	2	2	▼A16M-30-10-Δ	2	2	▼A16R-30-10-Δ
-	-	-	-	-	-	-	-	-	-	-	-
40	28	7.5	10	20	25	2	2	▼A26M-30-10-Δ	2	2	▼A26R-30-10-Δ
-	-	-	-	-	-	-	-	-	-	-	-
50	34	10	10	25	30	2	2	A30M-30-10-Δ	2	2	A30R-30-10-Δ
-	-	-	-	-	-	-	-	-	-	-	-
60	42	10	15	30	40	2	2	A40M-30-10-Δ	2	2	A40R-30-10-Δ
-	-	-	-	-	-	-	-	-	-	-	-
80	54	15	20	40	50	2	2	A50M-30-11-Δ	2	2	A50R-30-11-Δ
90	68	20	25	50	60	2	2	A63M-30-11-Δ	2	2	A63R-30-11-Δ
105	80	25	30	60	75	2	2	A75M-30-11-Δ	2	2	A75R-30-11-Δ
150	88	30	30	60	75	2	2	A95M-30-11-Δ	2	2	A95R-30-11-Δ
150	104	30	40	75	100	2	2	A110M-30-11-Δ	2	2	A110R-30-11-Δ
230	130	40	50	100	125	2	2	A145M-30-11-Δ	2	2	A145R-30-11-Δ
250	156	50	60	125	150	2	2	A185M-30-11-Δ	2	2	A185R-30-11-Δ
300	192	60	75	150	200	2	2	A210M-30-11-Δ	2	2	A210R-30-11-Δ
350	248	75	100	200	250	2	2	A260M-30-11-Δ	2	2	A260R-30-11-Δ
400	302	100	100	250	300	2	2	A300M-30-11-Δ	2	2	A300R-30-11-Δ

▼ Planned legacy product; recommend AF series contactors.

Coil voltage selection chart (Δ)

Rated control circuit voltage U _c ④	A9...A300
24V AC	81
48V AC	83
110...120V AC, 60 Hz	84
230...240V AC, 60 Hz	80
480V AC, 60 Hz	51
600V AC, 60 Hz	55

Example(s):
24V AC input voltage: A16M-30-10-81
120V AC input voltage: A300R-30-11-84

Reversing vs. mechanically interlocked

Full voltage reversing contactors are pre-assembled using two (2) contactors, a mechanical interlock, an electrical interlock, and reversing busbars. Mechanically interlocked contactors are offered less the reversing bus.

① For selection purposes, for complete electrical ratings, see Technical Data
② For ratings according to IEC/EN 60947-4-1, refer to A non-reversing selection table or Technical Data.
③ A9R(M)...A16R(M) mounted on 35mm DIN rail, A26R(M)...A300R(M) mounted on common baseplate.
④ AC coil input voltage(s) at 50/60 Hz unless specified. For additional coil voltages, see page 1.35.

AE non-reversing, 3-pole

For applications up to 75 hp, 40 kW
DC operated, double-wound coils



A50... AE75

Electrical ratings ①

IEC/EN 60947-4-1						UL 508, 60947-4-1A CSA C22.2 No.14, 60947-4-1-07				Non-reversing		Catalog number	
Rated operational current I _e AC-1, AC-3 (A)		Rated operational power P _e , AC-3, 55°C (kW)			AC general purpose ratings (A)	Maximum motor switching current (A)	AC motor ratings, breaking all lines, three phase, 50/60 Hz (hp)				Standard auxiliary contacts ②		
AC-1, 40°C	AC-3, 55°C	220... 240V	380... 400V	690V	600V		200... 208V	220... 240V	440... 480V	550... 600V	NO		NC
25	9	2.2	4	5.5	21	9	2	2	5	7.5	1	1	▼ AE9-30-11-Δ
27	12	3	5.5	7.5	25	11	3	3	7.5	10	1	1	▼ AE12-30-11-Δ
30	17	4	7.5	9	30	17	5	5	10	15	1	1	▼ AE16-30-11-Δ
45	26	6.5	11	15	40	28	7.5	10	20	25	1	1	▼ AE26-30-11-Δ
55	32	9	15	18.5	50	34	10	10	25	30	1	1	AE30-30-11-Δ
60	37	11	18.5	22	60	42	10	15	30	40	1	1	AE40-30-11-Δ
100	50	15	22	30	80	54	15	20	40	50	1	1	AE50-30-11-Δ
115	65	18.5	30	37	90	68	20	25	50	60	1	1	AE63-30-11-Δ
125	75	22	37	40	105	80	25	30	60	75	1	1	AE75-30-11-Δ

▼ Planned legacy product; recommend AF series contactors.

Coil voltage selection chart (Δ)

Rated control circuit voltage U _c ③	AE9...AE75
12V DC	80
24V DC	81
48V DC	83
125V DC	87
220V DC	88
240V DC	89

Example: 125V DC input voltage: AE75-30-11-87

Double wound coils

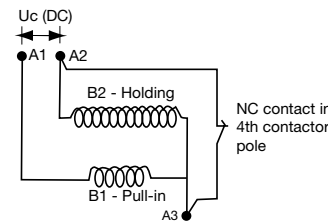

AE9 to AE40

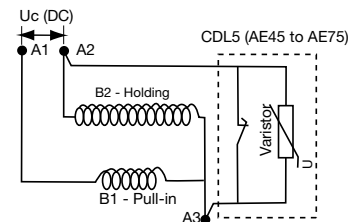

AE45 to AE75

① For selection purposes, for complete electrical ratings, see Technical Data

② All auxiliary contacts are side-mount.

③ For additional coil voltages, see page 1.35.

AE mechanically interlocked, reversing, 3-pole

For applications up to 75 hp, 40 kW
DC operated, double-wound coils



AE50M... AE75M



AE50R...AE75R

Electrical ratings ①②

UL 508, 60947-4-1A
CSA C22.2 No.14, 60947-4-1-07



AC general purpose ratings (A)	Maximum motor switching current (A)	AC motor ratings, breaking all lines, three phase, 50/60 Hz (hp)				Mechanically interlocked		Catalog number ③	Reversing		Catalog number ③
		200... 208V	220... 240V	440... 480V	550... 600V	Standard auxiliary contacts	Standard auxiliary contacts				
600V						NO	NC		NO	NC	
21	9	2	2	5	7.5	2	2	▼ AE9M-30-11-Δ	2	2	▼ AE9R-30-11-Δ
25	11	3	3	7.5	10	2	2	▼ AE12M-30-11-Δ	2	2	▼ AE12R-30-11-Δ
30	17	5	5	10	15	2	2	▼ AE16M-30-11-Δ	2	2	▼ AE16R-30-11-Δ
40	28	7.5	10	20	25	2	2	▼ AE26M-30-11-Δ	2	2	▼ AE26R-30-11-Δ
50	34	10	10	25	30	2	2	AE30M-30-11-Δ	2	2	AE30R-30-11-Δ
60	42	10	15	30	40	2	2	AE40M-30-11-Δ	2	2	AE40R-30-11-Δ
80	54	15	20	40	50	2	2	AE50M-30-11-Δ	2	2	AE50R-30-11-Δ
90	68	20	25	50	60	2	2	AE63M-30-11-Δ	2	2	AE63R-30-11-Δ
105	80	25	30	60	75	2	2	AE75M-30-11-Δ	2	2	AE75R-30-11-Δ

▼ Planned legacy product; recommend AF series contactors.

Coil voltage selection chart (Δ)

Rated control circuit voltage Uc ④	AE9...AE75
12V DC	80
24V DC	81
48V DC	83
125V DC	87
220V DC	88
240V DC	89

Example: 125V DC input voltage: AE75R-30-11-87

Reversing vs. mechanically interlocked

Full voltage reversing contactors are pre-assembled using two (2) contactors, a mechanical interlock, an electrical interlock, and reversing busbars. Mechanically interlocked contactors are offered less the reversing bus.

① For selection purposes, for complete electrical ratings, see Technical Data
 ② For ratings according to IEC/EN 60947-4-1, refer to AE non-reversing selection table or Technical Data.
 ③ AE9R(M)...AE16R(M) mounted on 35mm DIN rail, AE26R(M)...AE75R(M) mounted on common baseplate.
 ④ For additional coil voltages, see page 1.35.

AL non-reversing, 3-pole

For applications up to 40 hp, 18.5 kW
Low power consumption, DC operated coils



AL9-30-10-81



AL26-30-10-81



AL40-30-10-81

Electrical ratings ①

IEC/EN 60947-4-1

UL 508, 60947-4-1A
CSA C22.2 No.14, 60947-4-1-07

Rated operational current I _e AC-1, AC-3 (A)		Rated operational power P _e , AC-3, 55°C (kW)			AC general purpose ratings (A)	Maximum motor switching current (A)	AC motor ratings, breaking all lines, three phase, 50/60 Hz (hp)				Standard auxiliary contacts ②		Catalog number
AC-1, 40°C	AC-3, 55°C	220... 240V	380... 400V	690V	600V		200... 208V	220... 240V	440... 480V	550... 600V	NO	NC	
25	9	2.2	4	5.5	21	9	2	2	5	7.5	1	-	▼AL9-30-10-Δ ▼AL9-30-01-Δ
27	12	3	5.5	7.5	25	11	3	3	7.5	10	1	-	▼AL12-30-10-Δ ▼AL12-30-01-Δ
30	17	4	7.5	9	30	17	5	5	10	15	1	-	▼AL16-30-10-Δ ▼AL16-30-01-Δ
45	26	6.5	11	11	40	28	7.5	10	20	25	1	-	▼AL26-30-10-Δ ▼AL26-30-01-Δ
55	32	9	15	15	50	34	10	10	25	30	1	-	AL30-30-10-Δ AL30-30-01-Δ
60	37	11	18.5	18.5	60	42	10	15	30	40	1	-	AL40-30-10-Δ AL40-30-01-Δ

▼ Planned legacy product; recommend AF series contactors.

Non-reversing & reversing

Coil voltage selection chart (Δ)

Rated control circuit voltage U _c ③	AL9... AL40
12V DC	80
24V DC	81
48V DC	83
125V DC	87
220V DC	88
240V DC	89

Example(s):
24V DC input voltage: AL30-30-10-81
125V DC input voltage: AL40-30-10-87

① For selection purposes, for complete electrical ratings, see Technical Data

② Auxiliary contacts integral for AL9... AL40.

③ For additional coil voltages, see page 1.35.

AL mechanically interlocked, reversing, 3-pole

For applications up to 40 hp, 18.5 kW
Low power consumption, DC operated coils

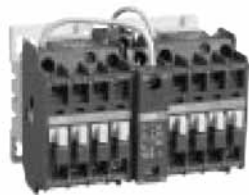

AL9M...AL16M

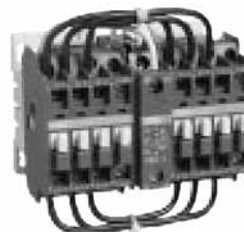

AL9R...AL16R

Electrical ratings ①②

UL 508, 60947-4-1A
CSA C22.2 No.14, 60947-4-1-07



AC general purpose ratings (A)	Maximum motor switching current (A)	AC motor ratings, breaking all lines, three phase, 50/60 Hz (hp)				Mechanically interlocked		Catalog number	Reversing		Catalog number
		200... 208V	220... 240V	440... 480V	550... 600V	Standard auxiliary contacts	NO		NC	Standard auxiliary contacts	
600V						NO	NC				
21	9	2	2	5	7.5	2	2	▼AL9M-30-10-Δ	2	2	▼AL9R-30-10-Δ
-	-	-	-	-	-	-	-	-	-	-	-
25	11	3	3	7.5	10	2	2	▼AL12M-30-10-Δ	2	2	▼AL12R-30-10-Δ
-	-	-	-	-	-	-	-	-	-	-	-
30	17	5	5	10	15	2	2	▼AL16M-30-10-Δ	2	2	▼AL16R-30-10-Δ
-	-	-	-	-	-	-	-	-	-	-	-
40	28	7.5	10	20	25	2	2	▼AL26M-30-10-Δ	2	2	▼AL26R-30-10-Δ
-	-	-	-	-	-	-	-	-	-	-	-
50	34	10	10	25	30	2	2	AL30M-30-10-Δ	2	2	AL30R-30-10-Δ
-	-	-	-	-	-	-	-	-	-	-	-
60	42	10	15	30	40	2	2	AL40M-30-10-Δ	2	2	AL40R-30-10-Δ
-	-	-	-	-	-	-	-	-	-	-	-

▼ Planned legacy product; recommend AF series contactors.

Coil voltage selection chart (Δ)

Rated control circuit voltage U _c ③	AL9... AL40
12V DC	80
24V DC	81
48V DC	83
125V DC	87
220V DC	88
240V DC	89

Example(s):

24V DC input voltage: AL30M-30-10-81
125V DC input voltage: AL40R-30-10-87

Reversing vs. mechanically interlocked

Full voltage reversing contactors are pre-assembled using two (2) contactors, a mechanical interlock, an electrical interlock, and reversing busbars. Mechanically interlocked contactors are offered less the reversing bus.

① For selection purposes, for complete electrical ratings, see Technical Data
② For ratings according to IEC/EN 60947-4-1, refer to AL non-reversing selection table or Technical Data.
③ AL9R(M)...AL16R(M) mounted on 35mm DIN rail, AL26R(M)...AL40R(M) mounted on common baseplate.
④ For additional coil voltages, see page 1.35.

AS / ASL non-reversing, reversing 3-pole

For applications up to 10 hp, 7.5 kW

AC or DC operated coils, bulk packaged for high volume



AS(L)09...AS(L)16 single stack



AS(L)09...AS(L)16 double stack



VAS(L)09...VAS(L)

Electrical ratings ①

IEC/EN 60947-4-1

UL 508, 60947-4-1A
CSA C22.2 No.14, 60947-4-1-07

Non-reversing and reversing

Rated operational current Ie AC-1, AC-3 (A)		Rated operational power Pe, AC-3, 60°C (kW)			AC general purpose ratings (A)	Maximum motor switching current (A)	AC motor ratings, breaking all lines, three phase, 50/60 Hz (hp)				Standard auxiliary contacts ②		Catalog number
AC-1, 40°C	AC-3, 60°C	220... 240V	380... 400V	690V	600V	200... 208V	220... 240V	440... 480V	550... 600V	NO	NC		

Type AS, AC controlled, non-reversing

22	9	2.2	4	4	20	9	2	2	5	7.5	1	-	AS09-30-10-ΔM
											-	1	AS09-30-01-ΔM
											3	2	AS09-30-32-ΔM
24	12	3	5.5	5.5	20	11	2	3	7.5	10	1	-	AS12-30-10-ΔM
											-	1	AS12-30-01-ΔM
											3	2	AS12-30-32-ΔM
24	15.5	4	7.5	7.5	20	15.2	3	5	10	10	1	-	AS16-30-10-ΔM
											-	1	AS16-30-01-ΔM
											3	2	AS16-30-32-ΔM

Type ASL, DC controlled, non-reversing

22	9	2.2	4	4	20	9	2	2	5	7.5	1	-	ASL09-30-10-ΔM
											-	1	ASL09-30-01-ΔM
											3	2	ASL09-30-32-ΔM
24	12	3	5.5	5.5	20	11	2	3	7.5	10	1	-	ASL12-30-10-ΔM
											-	1	ASL12-30-01-ΔM
											3	2	ASL12-30-32-ΔM
24	15.5	4	7.5	7.5	20	15.2	3	5	10	10	1	-	ASL16-30-10-ΔM
											-	1	ASL16-30-01-ΔM
											3	2	ASL16-30-32-ΔM

Type AS, AC controlled, reversing

22	9	2.2	4	4	20	9	2	2	5	7.5	-	2	VAS09EM-ΔM
24	12	3	5.5	5.5	20	11	2	3	7.5	10	-	2	VAS12EM-ΔM
24	15.5	4	7.5	7.5	20	15.2	3	5	10	10	-	2	VAS16EM-ΔM

Type ASL, DC controlled, reversing

22	9	2.2	4	4	20	9	2	2	5	7.5	-	2	VASL09EM-ΔM
24	12	3	5.5	5.5	20	11	2	3	7.5	10	-	2	VASL12EM-ΔM
24	15.5	4	7.5	7.5	20	15.2	3	5	10	10	-	2	VASL16EM-ΔM

Coil voltage selection chart (Δ)

Rated control circuit voltage Uc ③	AS09... AS16	ASL09... ASL16	VAS09... VAS16	VASL09... VASL16
12V DC	-	80	-	-
24V AC	20	-	20	-
24V DC	-	81	-	81
48V DC	-	83	-	83
115V AC	24	-	24	-
120V AC, 60 Hz	16	-	16	-
125V DC	-	87	-	87
220V DC	-	88	-	88
230V AC	26	-	26	-
400V AC	28	-	28	-

Example(s):

24V DC input voltage: ASL09-30-10-81M; 115V AC input voltage: AS16-30-01-24M

Standard bulk pack quantities (M)

Contactors	Quantity
AS(L)09...16-30-10	40
AS(L)09...16-30-01	40
AS(L)09...16-30-32	20
VAS09...VAS16	18

① For selection purposes, for complete electrical ratings, see Technical Data

② 3/2 auxiliary configurations include 1 NO integral contact with permanently attached 2/2 front-mount accessory.

③ AC coil input voltage(s) at 50/60 Hz unless specified. Additional voltages pg. 1.35.

AS / ASL non-reversing, spring-terminated, 3 pole

For applications up to 10 hp, 7.5 kW
AC or DC operated coils, bulk packaged for high volume

Across the line
Contactors



AS(L)09...AS(L)16 spring terminated, single stack



AS(L)09...AS(L)16 spring terminated, double stack

Electrical ratings ①

IEC/EN 60947-4-1					UL 508, 60947-4-1A CSA C22.2 No.14, 60947-4-1-07				Non-reversing		Catalog number	
Rated operational current I _e AC-1, AC-3 (A)		Rated operational power P _e , AC-3, 60°C (kW)			AC general purpose ratings (A)	Maximum motor switching current (A)	AC motor ratings, breaking all lines, three phase, 50/60 Hz (hp)					Standard auxiliary contacts ②
AC-1, 40°C	AC-3, 60°C	220... 240V	380... 400V	690V	600V		200... 208V	220... 240V	440... 480V	550... 600V	NO	NC

Type AS, AC controlled, spring-terminated, non-reversing

20	9	2.2	4	4	12	9	2	2	5	7.5	1	-	AS09-30-10S-ΔM
											-	1	AS09-30-01S-ΔM
											3	2	AS09-30-32S-ΔM
22	12	3	5.5	5.5	12	11	2	3	7.5	10	1	-	AS12-30-10S-ΔM
											-	1	AS12-30-01S-ΔM
											3	2	AS12-30-32S-ΔM
22	15.5	4	7.5	7.5	15.2	15.2	3	5	10	10	1	-	AS16-30-10S-ΔM
											-	1	AS16-30-01S-ΔM
											3	2	AS16-30-32S-ΔM

Type ASL, DC controlled, spring-terminated, non-reversing

20	9	2.2	4	4	12	9	2	2	5	7.5	1	-	ASL09-30-10S-ΔM
											-	1	ASL09-30-01S-ΔM
											3	2	ASL09-30-32S-ΔM
22	12	3	5.5	5.5	12	11	2	3	7.5	10	1	-	ASL12-30-10S-ΔM
											-	1	ASL12-30-01S-ΔM
											3	2	ASL12-30-32S-ΔM
22	15.5	4	7.5	7.5	15.2	15.2	3	5	10	10	1	-	ASL16-30-10S-ΔM
											-	1	ASL16-30-01S-ΔM
											3	2	ASL16-30-32S-ΔM

Coil voltage selection chart (Δ)

Rated control circuit voltage U _c ③	AS09... AS16	ASL09... ASL16
12V DC	-	80
24V AC	20	-
24V DC	-	81
48V DC	-	83
115V AC	24	-
120V AC, 60 Hz	16	-
125V DC	-	87
220V DC	-	88
230V AC	26	-
400V AC	28	-

Example(s):

24V DC input voltage: ASL09-30-10S-81M

115V AC input voltage: AS16-30-01S-24M

Standard bulk pack quantities (M)

Contactors	Quantity
AS(L)09...16-30-10	40
AS(L)09...16-30-01	40
AS(L)09...16-30-32	20
VAS09...VAS16	18

① For selection purposes, for complete electrical ratings, see Technical Data

② 3/2 auxiliary configurations include 1 NO integral contact with permanently attached 2/2 front-mount accessory.

③ AC coil input voltage(s) at 50/60 Hz unless specified. Additional voltages pg. 1.35.

B miniature non-reversing, mechanically interlocked, 3-pole

For applications up to 5 hp, 5.5 kW
AC operated coils, screw, quick-connect & PCB mount termination



B6...B7



B6(-F)...B7(-F)



B6(-P)...B7(-P)

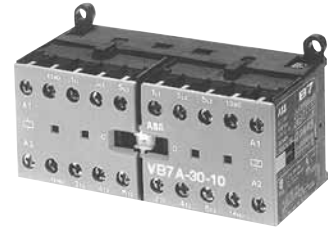

VB6...VB7

Electrical ratings ①

IEC/EN 60947-4-1					UL 508, 60947-4-1A CSA C22.2 No.14, 60947-4-1-07							Non-reversing & mechanically interlocked		Catalog number
Rated operational current I _e AC-1, AC-3 (A)		Rated operational power P _e , AC-3, 55°C (kW)			AC general purpose ratings (A)	Maximum motor switching current (A)	AC motor ratings, breaking all lines, three phase, 50/60 Hz (hp)				Standard auxiliary contacts			
AC-1, 40°C	AC-3, 55°C	220... 240V	380... 400V	690V	600V		200... 208V	220... 240V	440... 480V	550... 600V	NO	NC		

Type B, screw terminated, non-reversing

20	8	2.2	4	3	12 ②	6.8	1	2	3	1	1	-	B6-30-10-Δ
											-	1	B6-30-01-Δ
20	12	3	5.5	3	16	9.6	2	3	5	5	1	-	B7-30-10-Δ
											-	1	B7-30-01-Δ

Type B, quick-connect (flat pin), non-reversing

16	8	2.2	4	3	12 ②	6.8	1	2	3	1	1	-	B6-30-10-FΔ
											-	1	B6-30-01-FΔ
16	12	3	5.5	3	16	9.6	2	3	5	5	1	-	B7-30-10-FΔ
											-	1	B7-30-01-FΔ

Type B, printed circuit board mount (solder pin), non-reversing

12	8	2.2	4	3	8 ②	6.8	1	2	3	1	1	-	B6-30-10-PΔ
											-	1	B6-30-01-PΔ
12	12	3	5.5	3	16	9.6	2	3	5	5	1	-	B7-30-10-PΔ
											-	1	B7-30-01-PΔ

Type B, screw terminated, mechanically interlocked

20	8	2.2	4	3	12 ②	6.8	1	2	3	1	2	-	VB6-30-10-Δ
											-	2	VB6-30-01-Δ
20	12	3	5.5	3	16	9.6	2	3	5	5	2	-	VB7-30-10-Δ
											-	2	VB7-30-01-Δ

Type B, quick-connect (flat pin), mechanically interlocked

16	8	2.2	4	3	12 ②	6.8	1	2	3	1	2	-	VB6-30-10-FΔ
											-	2	VB6-30-01-FΔ
16	12	3	5.5	3	16	9.6	2	3	5	5	2	-	VB7-30-10-FΔ
											-	2	VB7-30-01-FΔ

Type B, printed circuit board mount (solder pin), mechanically interlocked

12	8	2.2	4	3	8 ②	6.8	1	2	3	1	2	-	VB6-30-10-PΔ
											-	2	VB6-30-01-PΔ
12	12	3	5.5	3	16	9.6	2	3	5	5	2	-	VB7-30-10-PΔ
											-	2	VB7-30-01-PΔ

NOTE: Quick-connect and PCB mount versions are UL recognized only.

Coil voltage selection chart (Δ)

Rated control circuit voltage U _c ③	(V)B6...(V)B7
24V AC	01
48V AC	03
110...127V AC	84
220...240V AC	80
380...415V AC	85

Example(s):

24V AC input voltage: B6-30-10-01
120V AC input voltage: VB7-30-10-84

- ① For selection purposes, for complete electrical ratings, see Technical Data
- ② 300V AC max.
- ③ AC coil input voltage(s) at 50/60 Hz unless specified. Additional voltages pg. 1.35.

BC miniature non-reversing, mech. interlocked, 3 pole

For applications up to 5 hp, 5.5 kW
DC operated coils, screw, quick-connect & PCB mount termination

Across the line
1



BC6...BC7



BC6(-F)...BC7(-F)



BC6(-P)...BC7(-P)



VBC6(-P)...VBC7(-P)

Electrical ratings ①

Non-reversing & mechanically interlocked

IEC/EN 60947-4-1					UL 508, 60947-4-1A CSA C22.2 No.14, 60947-4-1-07				Standard auxiliary contacts		Catalog number		
Rated operational current I _e AC-1, AC-3 (A)		Rated operational power P _e , AC-3, 55°C (kW)			AC general purpose ratings (A)	Maximum motor switching current (A)	AC motor ratings, breaking all lines, three phase, 50/60 Hz (hp)				NO	NC	
AC-1, 40°C	AC-3, 55°C	220... 240V	380... 400V	690V	600V		200... 208V	220... 240V	440... 480V	550... 600V			
Type BC, screw terminated, non-reversing													
20	8	2.2	4	3	12 ⊙	6.8	1	2	3	1	1	-	BC6-30-10-Δ
											-	1	BC6-30-01-Δ
20	12	3	5.5	3	16	9.6	2	3	5	5	1	-	BC7-30-10-Δ
											-	1	BC7-30-01-Δ
Type BC, quick-connect (flat pin), non-reversing													
16	8	2.2	4	3	12 ⊙	6.8	1	2	3	1	1	-	BC6-30-10-FA
											-	1	BC6-30-01-FA
16	12	3	5.5	3	16	9.6	2	3	5	5	1	-	BC7-30-10-FA
											-	1	BC7-30-01-FA
Type BC, printed circuit board mount (solder pin), non-reversing													
12	8	2.2	4	3	8 ⊙	6.8	1	2	3	1	1	-	BC6-30-10-PA
											-	1	BC6-30-01-PA
12	12	3	5.5	3	16	9.6	2	3	5	5	1	-	BC7-30-10-PA
											-	1	BC7-30-01-PA
Type BC, screw terminated, mechanically interlocked													
20	8	2.2	4	3	12 ⊙	6.8	1	2	3	1	2	-	VBC6-30-10-Δ
											-	2	VBC6-30-01-Δ
20	12	3	5.5	3	16	9.6	2	3	5	5	2	-	VBC7-30-10-Δ
											-	2	VBC7-30-01-Δ
Type BC, quick-connect (flat pin), mechanically interlocked													
16	8	2.2	4	3	12 ⊙	6.8	1	2	3	1	2	-	VBC6-30-10-FA
											-	2	VBC6-30-01-FA
16	12	3	5.5	3	16	9.6	2	3	5	5	2	-	VBC7-30-10-FA
											-	2	VBC7-30-01-FA
Type BC, printed circuit board mount (solder pin), mechanically interlocked													
12	8	2.2	4	3	8 ⊙	6.8	1	2	3	1	2	-	VBC6-30-10-PA
											-	2	VBC6-30-01-PA
12	12	3	5.5	3	16	9.6	2	3	5	5	2	-	VBC7-30-10-PA
											-	2	VBC7-30-01-PA

NOTE: Quick-connect and PCB mount versions are UL recognized only.

Coil voltage selection chart (Δ)

Rated control circuit voltage U _c ③	(M)BC6...(M)BC7
12V DC	07
24V DC	01
48V DC	16
110...125V DC	04
220...240V DC	05

Example(s):

24V DC input voltage: BC6-30-10-01

125V DC input voltage: VBC7-30-10-04

① For selection purposes, for complete electrical ratings, see Technical Data

② 300V AC max.

③ For additional coil voltages, see page 1.35.

AF / AFZ NEMA rated, non-reversing, 3-pole Class A controllers Sizes 00...8 Electronic AC/DC operated coils

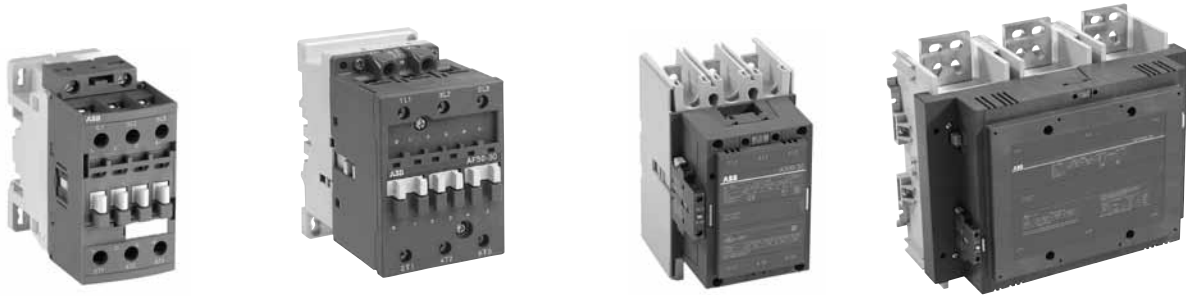

AF26N1(Z)

AF50N2...AF75N3

AF260N5

AF1650N

Electrical ratings ①

NEMA size	Continuous current rating (A)	NEMA ICS 2-2000 (R2005) NEMA AC motor ratings, breaking all lines (hp)								Non-reversing Standard auxiliary contacts ②		Catalog number
		Single phase, 50/60 Hz		Three phase, 60 Hz						NO	NC	
		120V	230V	200V	230V	380... 415V ③	460V	575V				
Type AF												
00	9	1/3	1	1.5	1.5	1.5	2	2	1	-	AF09N00-30-10-Δ	
									-	1	AF09N00-30-10-Δ	
0	18	1	2	3	3	5	5	5	1	-	AF12N0-30-10-Δ	
									-	1	AF12N0-30-10-Δ	
1	27	2	3	7.5	7.5	10	10	10	-	-	AF26N1-30-00-Δ	
2	45	3	7.5	10	15	25	25	25	1	1	AF50N2-30-11-Δ	
3	90	-	-	25	30	50	50	50	1	1	AF75N3-30-11-Δ	
4	135	-	-	40	50	75	100	100	1	1	AF145N4-3011-Δ	
5	270	-	-	75	100	150	200	200	1	1	AF260N5-3011-Δ	
6	540	-	-	150	200	300	400	400	1	1	AF460N6-3011-Δ	
7	810	-	-	-	300	-	600	600	1	1	AF750N7-3011-Δ	
8	1215	-	-	-	450	-	900	900	1	1	AF1650N83011-Δ	

Type AFZ, low-consumption coils

00	9	1/3	1	1.5	1.5	1.5	2	2	1	-	AF09N00Z-30-10-Δ
									-	1	AF09N00Z-30-01-Δ
0	18	1	2	3	3	5	5	5	1	-	AF12N0Z-30-10-Δ
									-	1	AF12N0Z-30-01-Δ
1	27	2	3	7.5	7.5	10	10	10	-	-	AF26N1Z-30-00-Δ

Coil voltage selection chart (Δ)

Rated control circuit voltage Uc 3	AF09N00... AF26N1	AF09N00Z... AF26N1Z	AF50N2... AF260N5	AF460N6... AF750N7	AF1650N8
12...20V DC	-	20	-	-	-
20...60V DC	11	21	72	-	-
24...60V AC	11	21	-	-	-
24...60V DC	-	-	-	68	-
48...130V AC/DC	12	22	69	69	-
100...250 V AC/DC	13	23	70	70	70
250...500 V AC/DC	14	-	-	71	-

Example(s):

24V DC input voltage: AF26N1-30-00-11

120V AC input voltage: AF750N7-3011-70

Control inputs

AF460N6...AF1650N8 are equipped with integral low voltage inputs, allowing for direct PLC control.

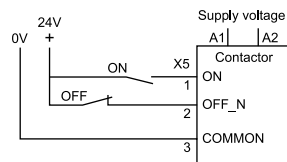

① For selection purposes, for complete electrical ratings, see Technical Data.

② Auxiliary contacts integral for AF09N00...AF16N0; side-mount for AF50N2...AF1650N8

③ 50 Hz.

④ AC coil input voltage(s) at 50/60 Hz unless specified.

AF / AFZ NEMA rated, mech. interlocked, reversing, 3P Class A controllers Sizes 00...7 Electronic AC/DC operated coils

Across the line
Contactors

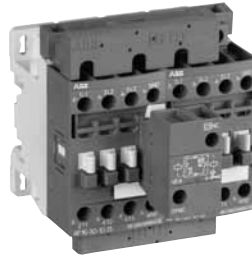

AF09N00R...AF16N0R

Electrical ratings ①②

NEMA ICS 2-2000 (R2005)



AC motor ratings, breaking all lines,
Three phase, 60 Hz (hp)

Mechanically interlocked

Reversing

NEMA size	Continuous current rating (A)	AC motor ratings, breaking all lines, Three phase, 60 Hz (hp)			Standard auxiliary contacts		Catalog number ②	Standard auxiliary contacts		Catalog number ②
		200V	230V	460...575V	NO	NC		NO	NC	
Type AF										
00	9	1.5	1.5	2	2	2	AF09N00M-3022-Δ	2	2	AF09N00R-3022-Δ
0	18	3	3	5	2	2	AF12N0M-3022-Δ	2	2	AF12N0R-3022-Δ
1	27	7.5	7.5	10	-	2	AF26N1M-3002-Δ	-	2	AF26N1R-3002-Δ
2	45	10	15	25	2	2	AF50N2M-3011-Δ	2	2	AF50N2R-3011-Δ
3	90	25	30	50	2	2	AF75N3M-3011-Δ	2	2	AF75N3R-3011-Δ
4	135	40	50	100	2	2	AF145N4M-11-Δ	2	2	AF145N4R-11-Δ
5	270	75	100	200	2	2	AF260N5M-11-Δ	2	2	AF260N5R-11-Δ
6	540	150	200	400	2	2	AF460N6M-11-Δ	2	2	AF460N6R-11-Δ
7	810	-	300	600	2	2	AF750N7M-11-Δ	2	2	AF750N7R-11-Δ
Type AFZ, low-consumption coils										
00	9	1.5	1.5	2	2	2	AF09N00MZ-3022-Δ	2	2	AF09N00RZ-3022-Δ
0	18	3	3	5	2	2	AF12N0MZ-3022-Δ	2	2	AF12N0RZ-3022-Δ
1	27	7.5	7.5	10	-	2	AF26N1MZ-3002-Δ	-	2	AF26N1RZ-3002-Δ

Coil voltage selection chart (Δ)

Rated control circuit voltage U _c 3	AF09N00... AF26N1	AF09N00Z... AF26N1Z	AF50N2... AF260N5	AF460N6... AF750N7
12...20V DC	-	20	-	-
20...60V DC	11	21	72	-
24...60V AC	11	21	-	-
24...60V DC	-	-	-	68
48...130V AC/DC	12	22	69	69
100...250 V AC/DC	13	23	70	70
250...500 V AC/DC	14	-	-	71

Example(s):

24V DC input voltage: AF26N1R-3002-11
120V AC input voltage: AF750N7R-11-70

Reversing vs. mechanically interlocked

Full voltage reversing contactors are pre-assembled using two (2) contactors, a mechanical interlock, an electrical interlock, and reversing busbars. Mechanically interlocked contactors are offered less the reversing bus.

① For selection purposes, for complete electrical ratings, see Technical Data.

② For ratings according to IEC/EN 60947-4-1, refer to AF NEMA rated, non-reversing selection table or Technical Data.

③ AF09N00R(M)...AF26N1R(M) assembled using connection clips, AF50N2R(M)...AF750N7R(M) mounted on common baseplate.

④ AC coil input voltage(s) at 50/60 Hz unless specified.

A, AL, AE NEMA rated, non-reversing, 3-pole Class A controllers Sizes 00...5 AC or DC operated coils



A26N1



A145N4

Electrical ratings ①

NEMA size	Continuous current rating (A)	NEMA ICS 2-2000 (R2005) NEMA								Non-reversing		Catalog number
		AC motor ratings, breaking all lines (hp)								Standard auxiliary contacts ②		
		Single phase, 50/60 Hz		Three phase, 60 Hz						NO	NC	
		120V	230V	200V	230V	380... 415V ③	460V	575V				
Type A, AC operated coils												
00	9	1/3	1	1.5	1.5	1.5	2	2	1	-	▼ A9N00-30-10-Δ	
0	18	1	2	3	3	5	5	5	1	-	▼ A16N0-30-10-Δ	
1	27	2	3	7.5	7.5	10	10	10	1	-	▼ A26N1-30-10-Δ	
2	45	3	7.5	10	15	25	25	25	1	1	A50N2-30-11-Δ	
3	90	-	-	25	30	50	50	50	1	1	A75N3-30-11-Δ	
4	135	-	-	40	50	75	100	100	1	1	A145N4-30-11-Δ	
5	270	-	-	75	100	150	200	200	1	1	A260N5-30-11-Δ	
Type AL, DC operated coils												
00	9	1/3	1	1.5	1.5	1.5	2	2	1	-	▼ AL9N00-30-10-Δ	
0	18	1	2	3	3	5	5	5	1	-	▼ AL16N0-30-10-Δ	
1	27	2	3	7.5	7.5	10	10	10	1	-	▼ AL26N1-30-10-Δ	
Type AE, double-wound DC operated coils												
00	9	1/3	1	1.5	1.5	1.5	2	2	1	-	▼ AE9N00-30-11-Δ	
0	18	1	2	3	3	5	5	5	1	-	▼ AE16N0-30-11-Δ	
1	27	2	3	7.5	7.5	10	10	10	1	-	▼ AE26N1-30-11-Δ	
2	45	3	7.5	10	15	25	25	25	1	1	AE50N2-30-11-Δ	
3	90	-	-	25	30	50	50	50	1	1	AE75N3-30-11-Δ	

▼ Planned legacy product; recommend AF series contactors.

Coil voltage selection chart (Δ)

Rated control circuit voltage Uc ④	A9N00... A260N5	AL9N00... AL26N1	AE9N00... AE75N3
12V DC	-	80	80
24V AC	81	-	-
24V DC	-	81	81
110...120V AC, 60Hz	84	-	-
125V DC	-	87	87
220V DC	-	88	88
230...240V AC, 60 Hz	80	-	-
240V DC	-	89	89
480V AC, 60 Hz	51	-	-
600V AC, 60 Hz	55	-	-

Example(s):

24V DC input voltage: AL26N1-30-10-81
120V AC input voltage: A260N5-3011-84

① For selection purposes, for complete electrical ratings, see Technical Data.
② Auxiliary contacts integral for A9N00...A26N1 & AL9N00...AL26N1; side-mount for A50N2...A260N5 & AE9N00...AE75N3.
③ 50 Hz.
④ AC coil input voltage(s) at 50/60 Hz unless specified. Additional voltages pg. 1.35.

A, AL, AE NEMA rated, mech. interlocked, reversing Class A controllers Sizes 00...5; AC or DC operated coils

Across the line
Contactors

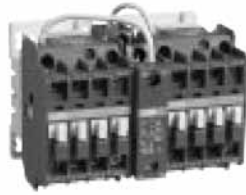

A9N00M...A16N0



A/E50N2...A/E75N3

Electrical ratings ①②

NEMA ICS 2-2000 (R2005) **NEMA**

Mechanically interlocked

Reversing

NEMA size	Continuous current rating (A)	AC motor ratings, breaking all lines, Three phase, 60 Hz (hp)			Standard auxiliary contacts		Catalog number ②	Standard auxiliary contacts		Catalog number ②
		200V	230V	460...575V	NO	NC		NO	NC	

Type A, AC operated coils

00	9	1.5	1.5	2	2	2	▼ A9N00M-10-Δ	2	2	▼ A9N00R-10-Δ
0	18	3	3	5	2	2	▼ A16N0M-10-Δ	2	2	▼ A16N0R-10-Δ
1	27	7.5	7.5	10	2	2	▼ A26N1M-10-Δ	2	2	▼ A26N1R-10-Δ
2	45	10	15	25	2	2	A50N2M-11-Δ	2	2	A50N2R-11-Δ
3	90	25	30	50	2	2	A75N3M-11-Δ	2	2	A75N3R-11-Δ
4	135	40	50	100	2	2	A145N4M-11-Δ	2	2	A145N4R-11-Δ
5	270	75	100	200	2	2	A260N5M-11-Δ	2	2	A260N5R-11-Δ

Type AL, DC operated coils

00	9	1.5	1.5	2	2	2	▼ AL9N00M-10-Δ	2	2	▼ AL9N00R-10-Δ
0	18	3	3	5	2	2	▼ AL16N0M-10-Δ	2	2	▼ AL16N0R-10-Δ
1	27	7.5	7.5	10	2	2	▼ AL26N1M-10-Δ	2	2	▼ AL26N1R-10-Δ

Type AE, double-wound DC operated coils

00	9	1.5	1.5	2	2	2	▼ AE9N00M-11-Δ	2	2	▼ AE9N00R-11-Δ
0	18	3	3	5	2	2	▼ AE16N0M-11-Δ	2	2	▼ AE16N0R-11-Δ
1	27	7.5	7.5	10	2	2	▼ AE26N1M-11-Δ	2	2	▼ AE26N1R-11-Δ
2	45	10	15	25	2	2	AE50N2M-11-Δ	2	2	AE50N2R-11-Δ
3	90	25	30	50	2	2	AE75N3M-11-Δ	2	2	AE75N3R-11-Δ

▼ Planned legacy product; recommend AF series contactors.

Coil voltage selection chart (Δ)

Rated control circuit voltage U _c ③	A9N00... A260N5	AL9N00... AL26N1	AE9N00... AE75N3
12V DC	-	80	80
24V AC	81	-	-
24V DC	-	81	81
110...120V AC, 60Hz	84	-	-
125V DC	-	87	87
220V DC	-	88	88
230...240V AC, 60 Hz	80	-	-
240V DC	-	89	89
480V AC, 60 Hz	51	-	-
600V AC, 60 Hz	55	-	-

Example(s):

24V DC input voltage: AL26N1M-10-81

120V AC input voltage: A260N5R-11-84

Reversing vs. mechanically interlocked

Full voltage reversing contactors are pre-assembled using two (2) contactors, a mechanical interlock, an electrical interlock, and reversing busbars. Mechanically interlocked contactors are offered less the reversing bus.

① For selection purposes, for complete electrical ratings, see Technical Data.

② For ratings according to IEC/EN 60947-4-1, refer to A, AL, AE NEMA rated, non-reversing selection table or Technical Data.

③ A(E)(L)9N00R(M)...A(E)(L)16N0R(M) mounted on 35mm DIN rail, A(E)(L)26N1R(M)...A260N5R(M) mounted on common baseplate.

④ AC coil input voltage(s) at 50/60 Hz unless specified. Additional voltages pg. 1.35.

AF, AFZ, and EK 4-pole

For resistive & slightly inductive applications up to 1000 A
AC & DC control



AF09(Z)...AF16(Z)



AF26(Z)...AF38(Z)



AF45...AF75

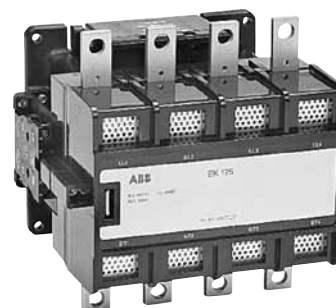

EK175...EK210

Electrical ratings ①

IEC/EN 60947-4-1	UL 508, 60947-4-1A CSA C22.2 No.14, 60947-4-1-07	Main (power) pole configuration ②		Standard auxiliary contacts		Catalog number
		NO	NC	NO	NC	
Rated operational current I _e , AC-1 (A)	AC general purpose ratings, 600V (A)					
Type AF, electronic AC/DC controlled						
25	25	4	-	-	-	AF09-40-00-Δ
		2	2	-	-	AF09-22-00-Δ
30	30	4	-	-	-	AF16-40-00-Δ
		2	2	-	-	AF16-22-00-Δ
45	45	4	-	-	-	AF26-40-00-Δ
		2	2	-	-	AF26-22-00-Δ
55	55	4	-	-	-	AF38-40-00-Δ
		2	2	-	-	AF38-22-00-Δ
70	65	4	-	-	-	AF45-40-00-Δ
		2	2	-	-	AF45-22-00-Δ
100	80	4	-	-	-	AF50-40-00-Δ
125	105	4	-	-	-	AF75-40-00-Δ
		2	2	-	-	AF75-22-00-Δ
Type EK, AC or DC controlled						
200	170	4	-	1	1	EK110C4P-ΔL
250	200	4	-	1	1	EK150C4P-ΔL
300	250	4	-	1	1	EK175C4P-ΔL
350	300	4	-	1	1	EK210C4P-ΔL
550	420	4	-	1	1	EK370C4P-ΔL
800	540	4	-	1	1	EK550C4P-ΔL
1000	-	4	-	1	1	EK1000C4P-ΔL
Type AFZ, electronic AC/DC controlled, low consumption						
25	25	4	-	-	-	AF09Z-40-00-Δ
		2	2	-	-	AF09Z-22-00-Δ
30	30	4	-	-	-	AF16Z-40-00-Δ
		2	2	-	-	AF16Z-22-00-Δ
45	45	4	-	-	-	AF26Z-40-00-Δ
		2	2	-	-	AF26Z-22-00-Δ
55	55	4	-	-	-	AF38Z-40-00-Δ
		2	2	-	-	AF38Z-22-00-Δ

Coil voltage selection chart (Δ)

Rated control circuit voltage U _c ③	AF09... AF38	AF09Z... AF38Z	AF45... AF75	EK110... EK1000
12...20V DC	-	20	-	-
20...60V DC	11	21	72	-
24...60V AC	11	21	-	-
24V AC, 60 Hz	-	-	-	F
24V DC	-	-	-	Y
48...130V AC/DC	12	22	69	-
110V 50 Hz, 120V 60 Hz	-	-	-	1
125V DC	-	-	-	Q
100...250 VAC/DC	13	23	70	-
220V DC	-	-	-	R
240V AC, 60 Hz	-	-	-	2
250...500 V AC/DC	14	-	-	-
480V AC, 60 Hz	-	-	-	4
600V AC, 60 Hz	-	-	-	6

Example(s):

24V DC input voltage: EK110C4P-YL
120V AC input voltage: AF75-40-11-70

- ① For selection purposes, for complete electrical ratings, see Technical Data.
- ② 2 NO & 2 NC contactors are not suitable for a reversing starter or wye-delta starter or for controlling a single load from 2 separate supplies. Please see technical data.
- ③ AC coil input voltage(s) at 50/60 Hz unless specified. Additional voltages pg. 1.35.

A, AL, and AE 4-pole

For resistive & slightly inductive applications up to 125 A
AC or DC control

Across the line
Contactors



A9...A16



A45...A75

Electrical ratings ①

IEC/EN 60947-4-1	UL 508, 60947-4-1A CSA C22.2 No.14, 60947-4-1-07	Main (power) pole configuration ②		Standard auxiliary contacts		Catalog number
		NO	NC	NO	NC	
Rated operational current I _e , AC-1 (A)	AC general purpose ratings, 600V (A)					
Type A, AC controlled						
25	21	4 2	- 2	- -	- -	▼ A9-40-00-Δ ▼ A9-22-00-Δ
30	30	4 2	- 2	- -	- -	▼ A16-40-00-Δ ▼ A16-22-00-Δ
45	40	- 4	- 4	- -	- -	A16-04-00-Δ ▼ A26-40-00-Δ ▼ A26-22-00-Δ
70	65	4 2	- 2	- -	- -	A45-40-00-Δ A45-22-00-Δ
100	80	4	-	-	-	A50-40-00-Δ
125	105	4 2	- 2	- -	- -	A75-40-00-Δ A75-22-00-Δ
Type AL, DC controlled						
25	21	4 2	- 2	- -	- -	▼ AL9-40-00-Δ ▼ AL9-22-00-Δ
30	30	4 2	- 2	- -	- -	▼ AL16-40-00-Δ ▼ AL16-22-00-Δ
45	40	4 2	- 2	- -	- -	▼ AL26-40-00-Δ ▼ AL26-22-00-Δ
Type AE, DC controlled						
70	65	4 2	- 2	- -	- -	AE45-40-00-Δ AE45-22-00-Δ
100	80	4	-	-	-	AE50-40-00-Δ
125	105	4 2	- 2	- -	- -	AE75-40-00-Δ AE75-22-00-Δ

▼ Planned legacy product; recommend AF series contactors.

Coil voltage selection chart (Δ)

Rated control circuit voltage U _c ③	A9...A75	AL9...AL26	AE9...AE75
12V DC	-	80	80
24V AC	81	-	-
24V DC	-	81	81
110...120V AC, 60Hz	84	-	-
125V DC	-	87	87
220V DC	-	88	88
230...240V AC, 60 Hz	80	-	-
240V DC	-	89	89
480V AC, 60 Hz	51	-	-
600V AC, 60 Hz	55	-	-

Example(s):

24V DC input voltage: AL26-40-00-81
120V AC input voltage: A75-40-00-84

① For selection purposes, for complete electrical ratings, see Technical Data.

② 2 NO & 2 NC contactors are not suitable for a reversing starter or wye-delta starter or for controlling a single load from 2 separate supplies. Please see technical data.

③ AC coil input voltage(s) at 50/60 Hz unless specified. For additional voltages, see page 1.35.

B, BC miniature, 4-pole

For resistive & slightly inductive applications up to 20 A
AC or DC control



B(C)6...B(C)7



B(C)6(-F)...B(C)7(-F)



B(C)6(-P)...B(C)7(-P)

Electrical ratings ①

Rated operational current I _e , AC-1 (A)	AC general purpose ratings, 600V (A)	Main (power) pole configuration		Standard auxiliary contacts		Catalog number
		NO	NC	NO	NC	
4-pole (4 NO & 2 NO / 2 NC)						
Type B, AC controlled, screw terminated						
20	12 ③	4	-	-	-	B6-40-00-Δ
		2	2	-	-	B6-22-00-Δ
20	16	4	-	-	-	B7-40-00-Δ
		2	2	-	-	B7-22-00-Δ
Type B, AC controlled, quick-connect (flat pin)						
16	12 ③	4	-	-	-	B6-40-00-FΔ
		2	2	-	-	B6-22-00-FΔ
16	16	4	-	-	-	B7-40-00-FΔ
		2	2	-	-	B7-22-00-FΔ
Type B, AC controlled, printed circuit board mount (solder pin)						
12	8 ③	4	-	-	-	B6-40-00-PΔ
		2	2	-	-	B6-22-00-PΔ
12	16	4	-	-	-	B7-40-00-PΔ
		2	2	-	-	B7-22-00-PΔ
Type BC, DC controlled, screw terminated						
20	12 ③	4	-	-	-	BC6-40-00-Δ
		2	2	-	-	BC6-22-00-Δ
20	16	4	-	-	-	BC7-40-00-Δ
		2	2	-	-	BC7-22-00-Δ
Type BC, DC controlled, quick-connect (flat pin)						
16	12 ③	4	-	-	-	BC6-40-00-FΔ
		2	2	-	-	BC6-22-00-FΔ
16	16	4	-	-	-	BC7-40-00-FΔ
		2	2	-	-	BC7-22-00-FΔ
Type BC, DC controlled, printed circuit board mount (solder pin)						
12	8 ③	4	-	-	-	BC6-40-00-PΔ
		2	2	-	-	BC6-22-00-PΔ
12	16	4	-	-	-	BC7-40-00-PΔ
		2	2	-	-	BC7-22-00-PΔ

NOTE: Quick connect and PCB mount versions are UL recognized only.

Coil voltage selection chart (Δ)

Rated control circuit voltage U _c ②	B6...B7	BC6...BC7
12V AC	-	07
24V AC	01	-
24V DC	-	01
48V AC	03	-
48V DC	-	16
110...127V AC	84	-
110...125V DC	-	04
220...240V AC	80	-
220...240V DC	-	05
380...415V AC	85	-

Example(s):
24V DC input voltage: BC6-40-00-01
120V AC input voltage: B7-22-00-84

① For selection purposes, for complete electrical ratings, see Technical Data.
② AC coil input voltage(s) at 50/60 Hz unless specified. Additional voltages pg. 1.35.
③ 300V AC max.

Additional coil voltages

3 & 4 pole contactors

AC & DC operated coils

For contactors	Coils for AC operated contactors (Δ)						Coils for DC operated contactors (Δ)			
	AC voltages		Coil code	For contactors	AC voltages		Coil code	For contactors	DC voltages V - DC	Coil code
	V - 50 Hz	V - 60 Hz			V - 50 Hz	V - 60 Hz				
A9...A300, A9N00... A260N5	24	24	81	(V)B6... (V)B7	24	24	01	AE9...AE75, AE9N00... AE75N3, AL9...AL40, AL9N00... AL26N1	12	80
	26	28	16		42	42	02		24	81
	28	32	17		48	48	03		42	82
	42	42	82		110...127	110...127	84		48	83
	48	48	83		220...240	220...240	80		50	21
	60	60	73		380...415	380...415	85		60	84
	100	100...110	74 ②	-	24	F	75		85	
	110	110...120	84	24	-	N	110		86	
	110...115	115...127	89 ③	-	48	G	125		87	
	120	140	29	110	120	1	220		88	
	125...127	150	30	-	208	B	240	89		
	175	208	34	-	240	2	250	38		
	190	220	36	EK110... EK1000	220...230	-	J	12	07	
	220...230	230...240	80	-	380	Z	24	01		
	230...240	240...260	88	380...400	440	3	(V)BC6... (V)BC7	42	02	
	230...240	277	42	400...415	-	M	48	16		
	230/400	-	62 ①	-	480	4	60	03		
	-	230/400	63 ①	500	-	5	110...125	04		
	380...400	400...415	85	-	600	6	220...240	05		
	400...415	415...440	86	24	24	20	24	Y		
	400...415	480	51	42	42	21	48	W		
	415...440	440...460	87	48	48	22	110	P		
	440	500	53	110	110	23	125	Q		
	500	600	55	115	115	24	220	R		
	550	-	56	-	120	16	440	T		
	660...690	-	58	(V)AS09... (V)AS16	220	220	25	12	80	
			230	230	26	24	81			
			240	240	27	48	83			
			-	277	17	60	84			
			380	-	13	110	86			
			400	400	28	125	87			
			415	415	29	220	88			
						240	89			

AF09(Z)...AF38(Z), AF09N00(Z)...AF26N1(Z), 3-pole Accessory fitting details

Contactor and main accessories (other accessories available)

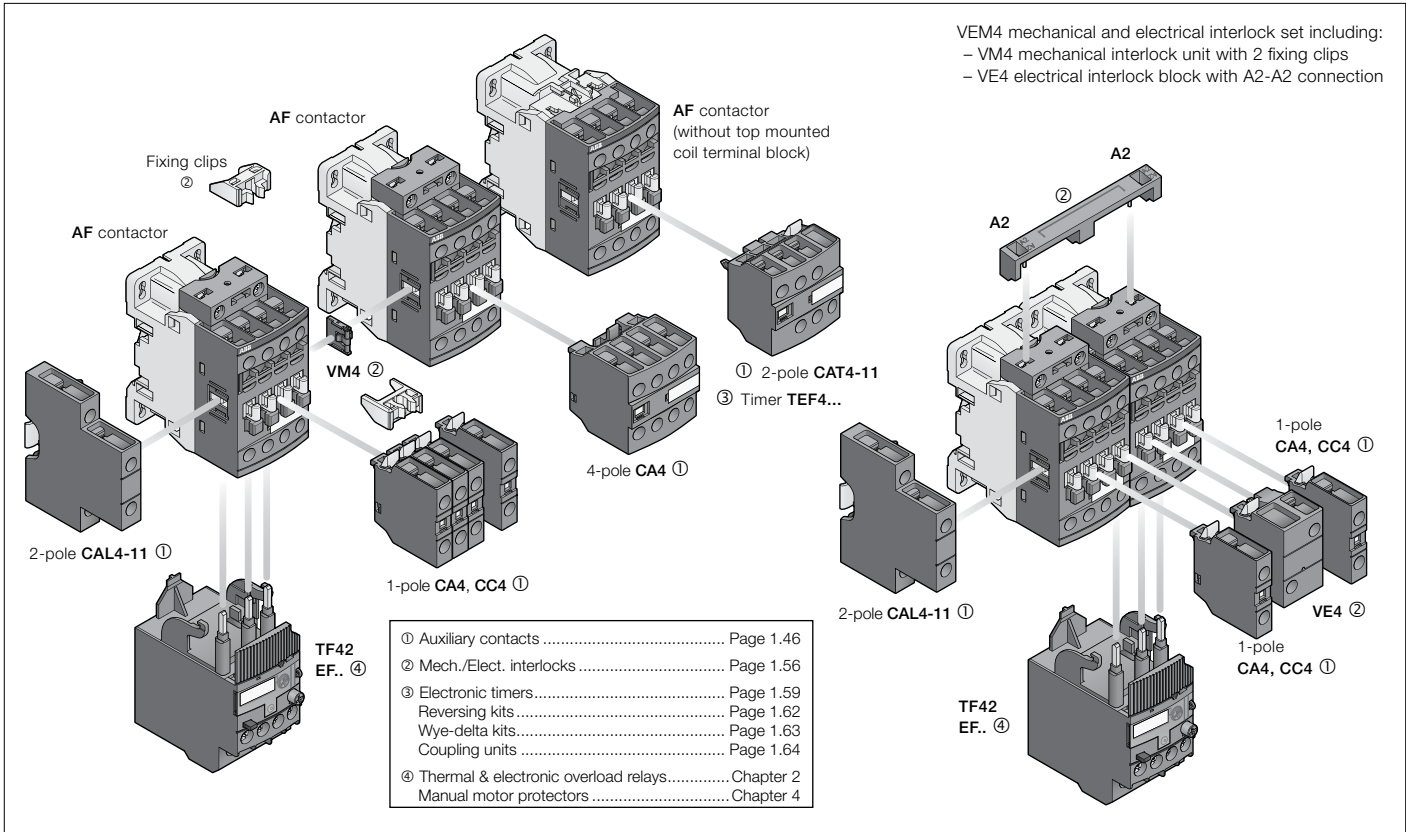

Main accessory fitting details

Many configurations of accessories are possible depending on whether these are front-mounted or side-mounted.

Contactor types	Main poles	Built-in auxiliary contacts	Front-mounted accessories				Electrical and mechanical interlock set (between 2 contactors)		Side-mounted accessories	
			Auxiliary contact blocks & electronic timers				VEM4		Auxiliary contact blocks	
			1-pole CA4 / CC4	2-pole CAT4-11	TEF4... or 4-pole CA4			Left side 2-pole CAL4-11	Right side	
Max. N.C. built-in and add-on N.C. auxiliary contacts: 4 N.C. max. on positions 1, 2, 3, 4 and 3 N.C. max. on positions 1 ±30°, 5										
AF09 ... AF16 Sz. 00...0	3	0	0	1	4 max. or 1	or 1	-	+	1	-
					2 max.	-	-	+	1	+ 1
					3 max.	-	+ 1	+	1	or 1
AF09 ... AF16	3	0	1	0	4 max. or 1	or 1	-	-	+ 1	-
AF26 ... AF38 Sz. 00...1	3	0	0	0	2 max. or 1	-	-	+	1	+ 1
					3 max.	-	+ 1	+	1	or 1

NOTE: Fitting details same for AF...Z contactors

Overload relays fitting details (1)

Contactor types	Thermal overload relays	Electronic overload relays
AF09 ... AF38, Sz. 00...1	TF42 (0.10...38 A)	EF19 (0.10...18.9 A)
AF26 ... AF38, Sz. 1	-	EF45 (9...38 A)

The addition of an overload relay on the contactor does not prevent fitting of many other accessories as shown above.

(1) Direct mounting - No kit required.

A/E/L30...A/E/L40; A/E/F50...A/E/F75; A/E/F50NZ...A/E/F75N3

3-pole contactors

Accessory fitting details

Contactor and main accessories (other accessories available)

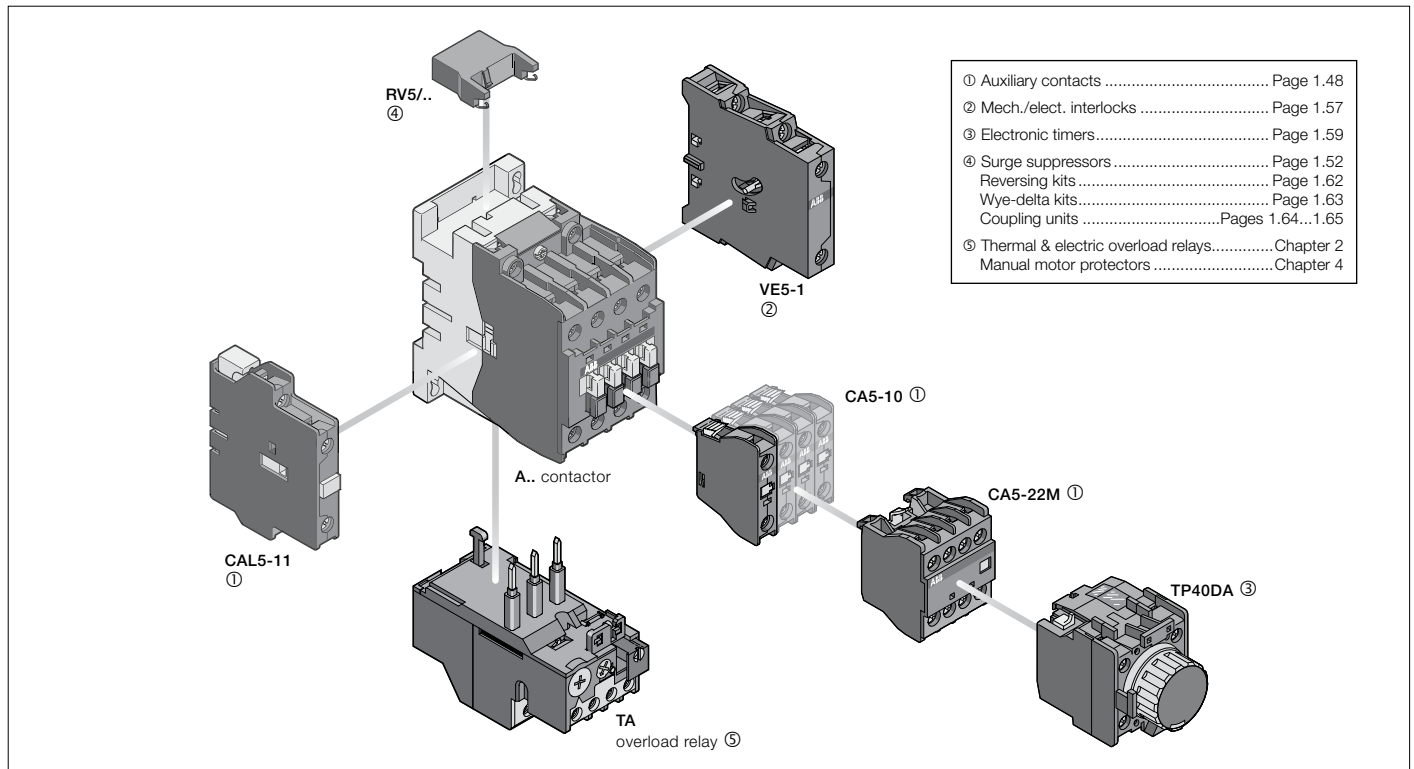

Main accessory fitting details

Many configurations of accessories are possible depending on whether these are front-mounted or side-mounted.

Contactor types	Main poles	Built-in auxiliary contacts	Front-mounted accessories			Side-mounted accessories		
			Auxiliary contact blocks		Electronic timer	Auxiliary contact blocks	Interlock unit blocks	
			1-pole CA5-..	4-pole CA5-..	TEF5	2-pole CAL5-11	VM5-.. or VE5-..	
A30...A40	3 0 1 0 3 0 0 1 (2)		1 to 5 x CA5-..	or 1 x CA5-.. (4-pole) + 1 x 1-pole CA5-..	or 1 x TEF5 + 1 x CA5-.. (1-pole)	+	1 to 2 x CAL5-11	or 1 x VM5-1 or VE5-1 + 1 x CAL5-11
A50 ... A75 Sz. 2...3	3 0 0 0		1 to 6 x CA5-..	or 1 x CA5-.. (4-pole) + 2 x 1-pole CA5-..	or 1 x TEF5 + 2 x CA5-.. (1-pole)	+	1 to 2 x CAL5-11	or 1 x VE5-2 + 1 x CAL5-11
AL30...AL40	3 0 1 0 3 0 0 1		1 to 5 x CA5-.. (2)	or 1 x CA5-.. (4-pole) (2) + 1 x 1-pole CA5-..	-	or	1 x CAL5-11 (3)	+ 1 x VM5-1 or VE5-1 (1)
AE50 ... AE75 Sz. 2...3	3 0 0 0		1 to 6 x CA5-..	or 1 x CA5-.. (4-pole) + 2 x 1-pole CA5-..	or 1 x TEF5 + 2 x CA5-.. (1-pole)	+	1 x CAL5-11	or 1 x VE5-2
AF50 ... AF75 Sz. 2...3	3 0 0 0		1 to 6 x CA5-..	or 1 x CA5-.. (4-pole) + 2 x 1-pole CA5-..	or 1 x TEF5 + 2 x CA5-.. (1-pole)	+	1 to 2 x CAL5-11	or 1 x VE5-2 + 1 x CAL5-11

(1) With VE5-1 interlock unit, a maximum of 3 N.O. auxiliary contacts are permitted. VE5-1, VM5-1 not allowed in mounting position 1 ±30°.

(2) 2 N.C. CA5-.. auxiliary contacts maximum in mounting position 5.

(3) CAL5-11 not allowed in mounting position 1±30°.

Overload relays fitting details (4)

Contactor types	Thermal overload relays	Electronic overload relays
A30...A40, AL30...AL40	TA25DU (0.1...32 A) or TA42DU (18...42 A)	E45DU (9...45 A)
A50 ... A75, AE50 ... AE75, AF50 ... AF75, Sz. 2...3	TA75DU (18...80 A)	E80DU (27...80 A)

The addition of an overload relay on the contactor does not prevent fitting of many other accessories as shown above.

(4) Direct mounting - No kit required.

A/F95...A/F110, 3-pole Accessory fitting details

Contactor and main accessories (other accessories available)

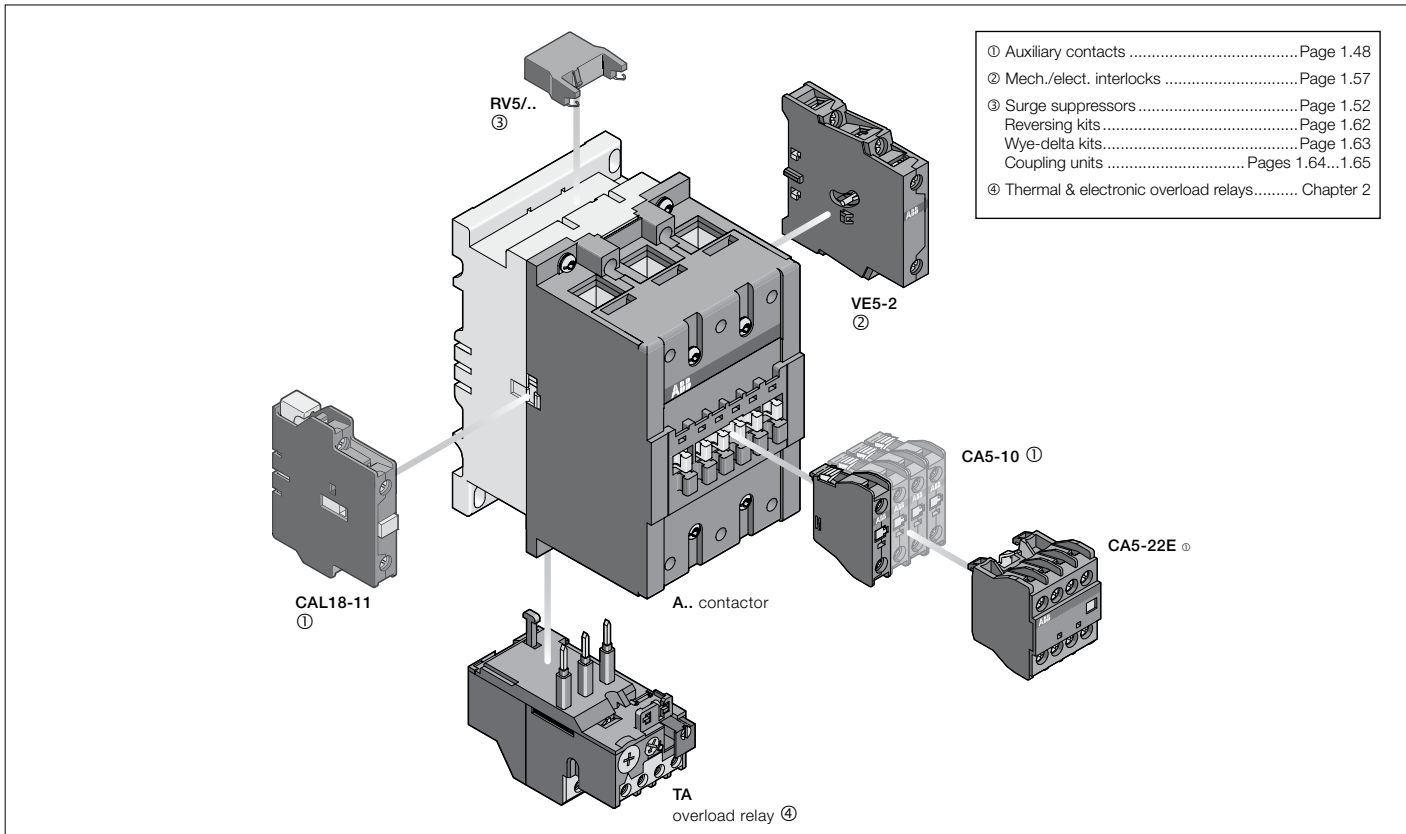

Main accessory fitting details

Many configurations of accessories are possible depending on whether these are front-mounted or side-mounted.

Contactor types	Main poles	Available auxiliary contacts	Front-mounted accessories		Side-mounted accessories	
			Auxiliary contact blocks		Auxiliary contact blocks	Interlock unit
			1-pole CA5- ..	4-pole CA5- ..	2-pole CAL..	VE5-2
A95, A110	3 0	0 0	1 to 6 x CA5-..	or 1 x CA5-.. (4-pole) + 2 x 1-pole CA5-..	+	1 to 2 x CAL18-11 or 1 x VE5-2 +1 x CAL18-11
AF95, AF110	3 0	0 0	1 to 6 x CA5-..	or 1 x CA5-.. (4-pole) + 2 x 1-pole CA5-..	+	1 to 2 x CAL18-11 or 1 x VE5-2 +1 x CAL18-11

Overload relays fitting details (1)

Contactor types	Thermal overload relays	Electronic overload relays
A95, A110	TA80DU (29...80 A) or TA110DU (65...110 A)	E140DU (50...140 A)
AF95, AF110		

The addition of an overload relay on the contactor does not prevent fitting of many other accessories as shown above.

(1) Direct mounting - No kit required.

A/F145...AF2050; A/F145N4...AF1650N8, 3-pole Accessory fitting details

Main accessories (other accessories available) AF185 shown on picture

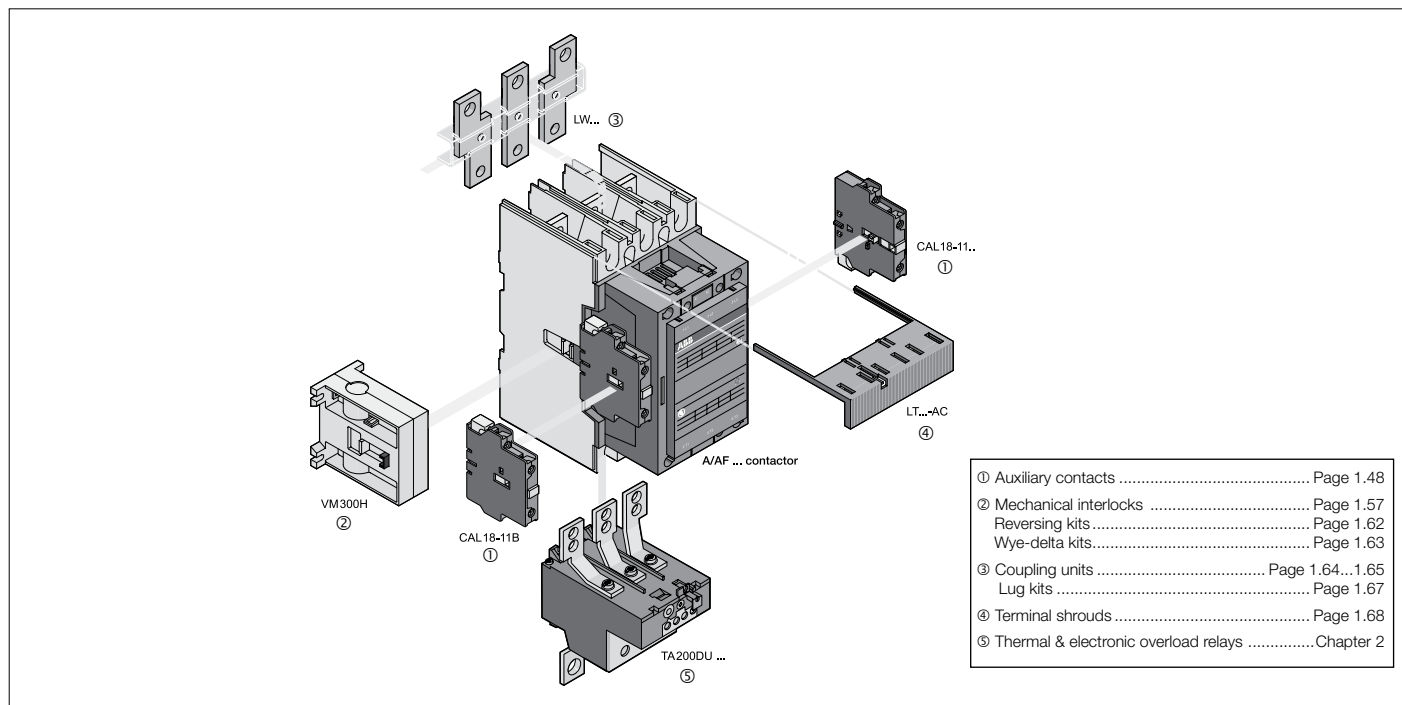

Main accessory fitting details

Contactor types	Main poles	Available auxiliary contacts	Side-mounted accessories Add-on auxiliary contact blocks	Mechanical interlock units	Mounting and positioning
			CAL18-11, CAL18-11B (3)	(for two horizontal mounted contactors)	Factory mounted auxiliary contacts Add-on CAL18-11 auxiliary contacts Add-on CAL18-11B auxiliary contacts

Contactors + auxiliary contact blocks

A145 ... A300 AF145 ... AF2050 Sz. 4...8	3	0	1	1	1 x CAL18-11 + 2 x CAL18-11B	-	
--	---	---	---	---	------------------------------	---	--

Contactors with mechanical interlocking + auxiliary contact blocks

A145 ... A185 AF145 ... AF185 Sz. 4	3	0	1	1	2 x CAL18-11 (1) + 3 x CAL18-11B (1)	+ VM...H (2)	
A210 ... A300 AF210 ... AF2050 Sz. 5...8	3	0	1	1	2 x CAL18-11 (1) + 4 x CAL18-11B (1)	+ VM...H (2)	

(1) Total number of auxiliary contact blocks for the two contactors. (2) Interlock type, according to the contactor ratings (see "Accessories").
(3) The CAL18-... auxiliary contact blocks can replace the CAL18-11 and CAL18-11B. Though, no auxiliary contact block can be mounted outside the CAL18-...

Overload relays fitting details

Contactor types	Thermal overload relays	Electronic overload relays
A145, A185, Sz. 4	TA200DU (80...200 A) (4)	E200DU (60...200 A) (4)
A210, A300, Sz. 5	TA450DU (100...310 A) (4) or TA450SU (130...310 A) (5)	E320DU (100...320 A) (4)
AF400, AF460, Sz. 6	-	E500DU (150...500 A) (5)
AF580, AF750, Sz. 7	-	E800DU (250...800 A) (5)
AF1350, AF1650, Sz. 8	-	E1250DU (375...1250 A) (5)

The addition of a thermal or electronic overload relay on the contactor does not prevent fitting of many other accessories as shown in "Main accessory fitting details" table.

(4) Direct mounting - No kit required.

(5) Mounting kit required (see "Motor protection").

AS/L09...AS/L16, 3 pole, w/screw terminals

Accessory fitting details

Contactor and main accessories (other accessories available)

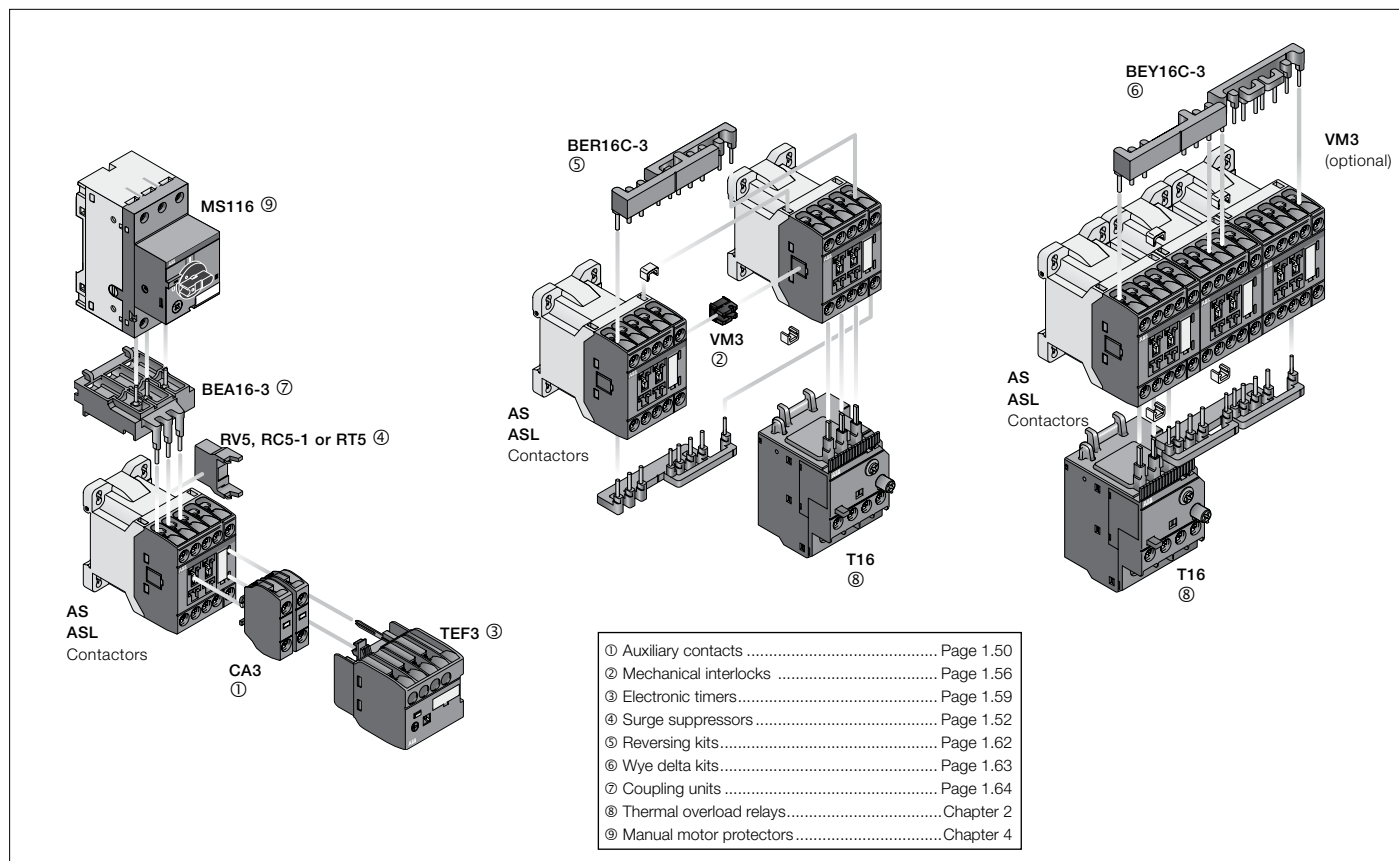

Main accessory fitting details

Many configurations of accessories are possible depending on whether these are front-mounted or side-mounted.

Contactor types	Main poles	Built-in auxiliary contacts	Front-mounted accessories			Side-mounted accessories	
			Auxiliary contact blocks	Electronic timer	Mechanical interlock unit (between 2 contactors)	Surge suppressors	
AS09 ... AS16	3 0	1 0	2 max.	or 1	+ 1	+ RV5	or RC5-1
AS09 ... AS16	3 0	3 2	-	-	1	+ RV5	or RC5-1
ASL09 ... ASL16	3 0	1 0	2 max.	or 1	+ 1	+ RV5	or RT5
ASL09 ... ASL16	3 0	0 1	-	-	1	+ RV5	or RT5

Overload relays fitting details (1)

Contactor types	Thermal overload relays
AS09 ... AS16	T16 (0.10...16 A)
ASL09 ... ASL16	

The addition of an overload relay on the contactor does not prevent fitting of many other accessories as shown above.

(1) Direct mounting - No kit required.

AS/L09...AS/L16, 3-pole w/spring terminals Accessory fitting details

Contactor and main accessories (other accessories available)

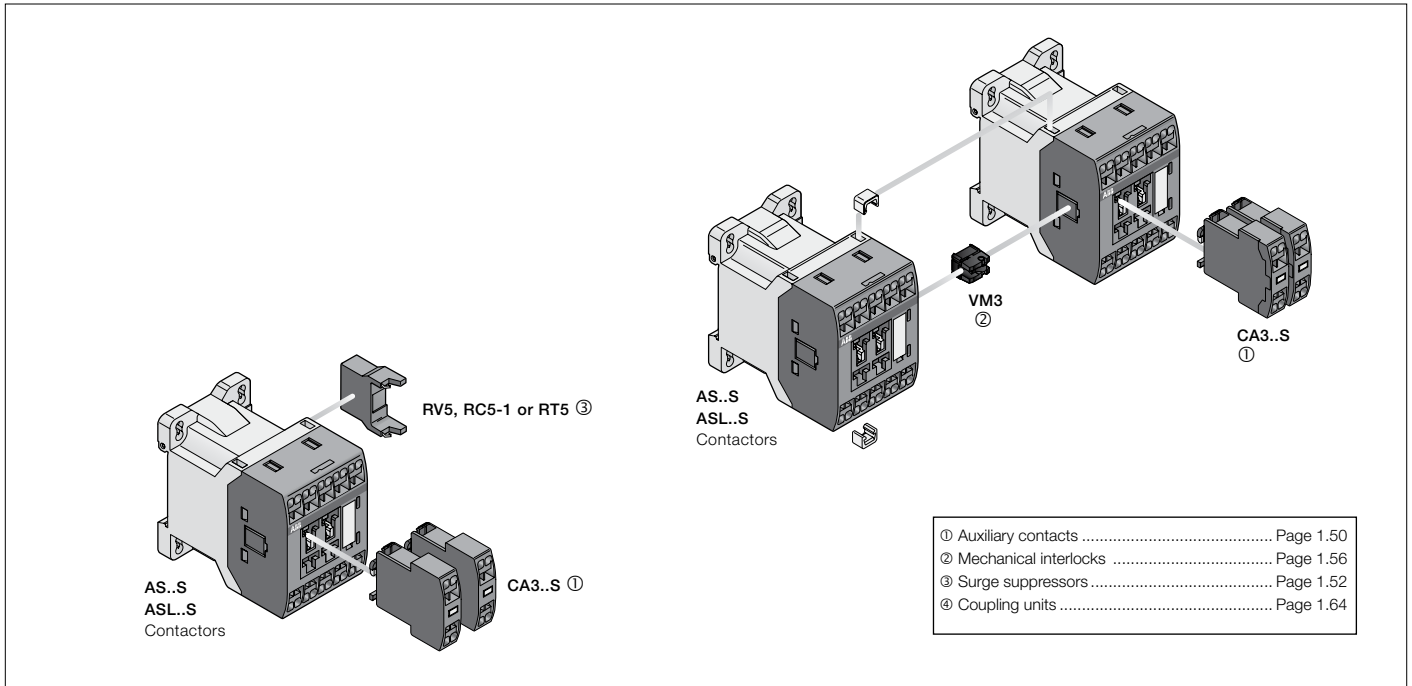

Main accessory fitting details

Contactor types	Main poles	Built-in auxiliary contacts	Front-mounted accessories		Side-mounted accessories	
			Auxiliary contact blocks	Mechanical interlock unit (between 2 contactors)	Surge suppressors	
			1-pole CA3..S	VM3		
AS09..S ... AS16..S	3 0	1 0	2 max.	+ 1	+	RV5 or RC5-1
AS09..S ... AS16..S	3 0	0 1				
AS09..S ... AS16..S	3 0	3 2	-	1	+	RV5 or RC5-1
ASL09..S ... ASL16..S	3 0	1 0	2 max.	+ 1	+	RV5 or RT5
ASL09..S ... ASL16..S	3 0	0 1				
ASL09..S ... ASL16..S	3 0	3 2	-	1	+	RV5 or RT5

AF09(Z)...AF38(Z), 4-pole Accessory fitting details

Contactor and main accessories (other accessories available)

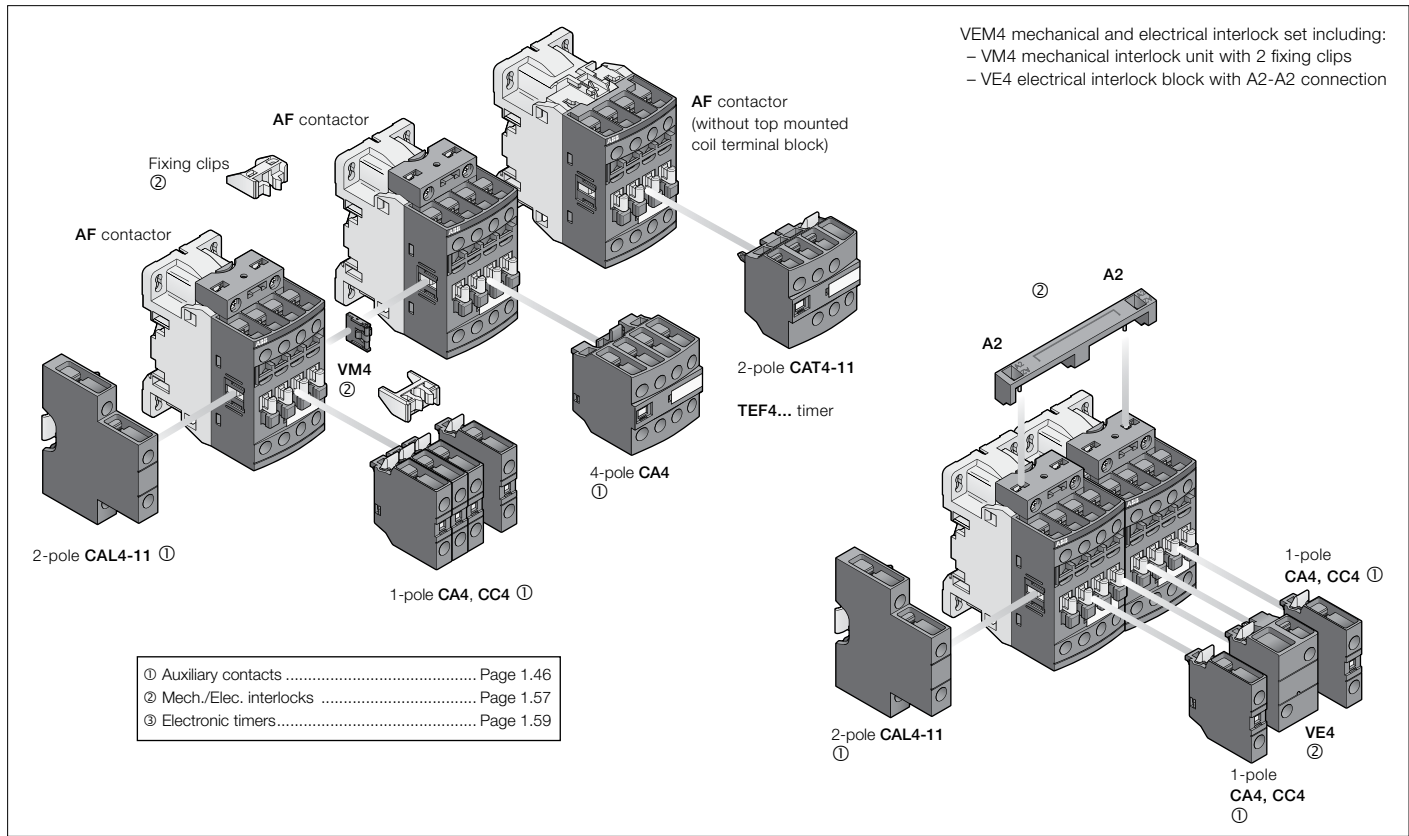

Main accessory fitting details

Many configurations of accessories are possible depending on whether these are front-mounted or side-mounted.

Contactor types	Main poles	Built-in auxiliary contacts	Front-mounted accessories			Electrical and mechanical interlock set (between 2 contactors)	Side-mounted accessories	
			Auxiliary contact blocks & electronic timers				Auxiliary contact blocks	
			1-pole CA4 / CC4	2-pole CAT4-11	TEF4... or 4-pole CA4	VEM4	Left side 2-pole CAL4-11	Right side
Max. add-on N.C. auxiliary contacts: 4 N.C. max. on positions 1, 2, 3, 4 and 3 N.C. max. on positions 1 ±30°, 5								
AF09, AF16	4	0	4 max.	or 1	or 1	–	+ 1	–
			2 max.	or 1	–	–	+ 1	+ 1
			3 max.	–	–	+ 1	+ 1	or 1
Max. add-on N.C. auxiliary contacts: 3 N.C. max. on positions 1, 2, 3, 4 and 2 N.C. max. on positions 1 ±30°, 5								
AF26, AF38	4	0	4 max.	or 1	or 1	–	+ 1	–
			2 max.	or 1	–	–	+ 1	+ 1
			3 max.	–	–	+ 1	+ 1	or 1
AF09, AF16	2	2	4 max.	or 1	or 1	–	+ 1	–
AF26, AF38	2	2	2 max.	or 1	–	–	+ 1	+ 1

NOTE: Fitting details same for AF...Z contactors.

A/E/F45...A/E/F75, 4-Pole Accessory fitting details

Contactor and main accessories (other accessories available)

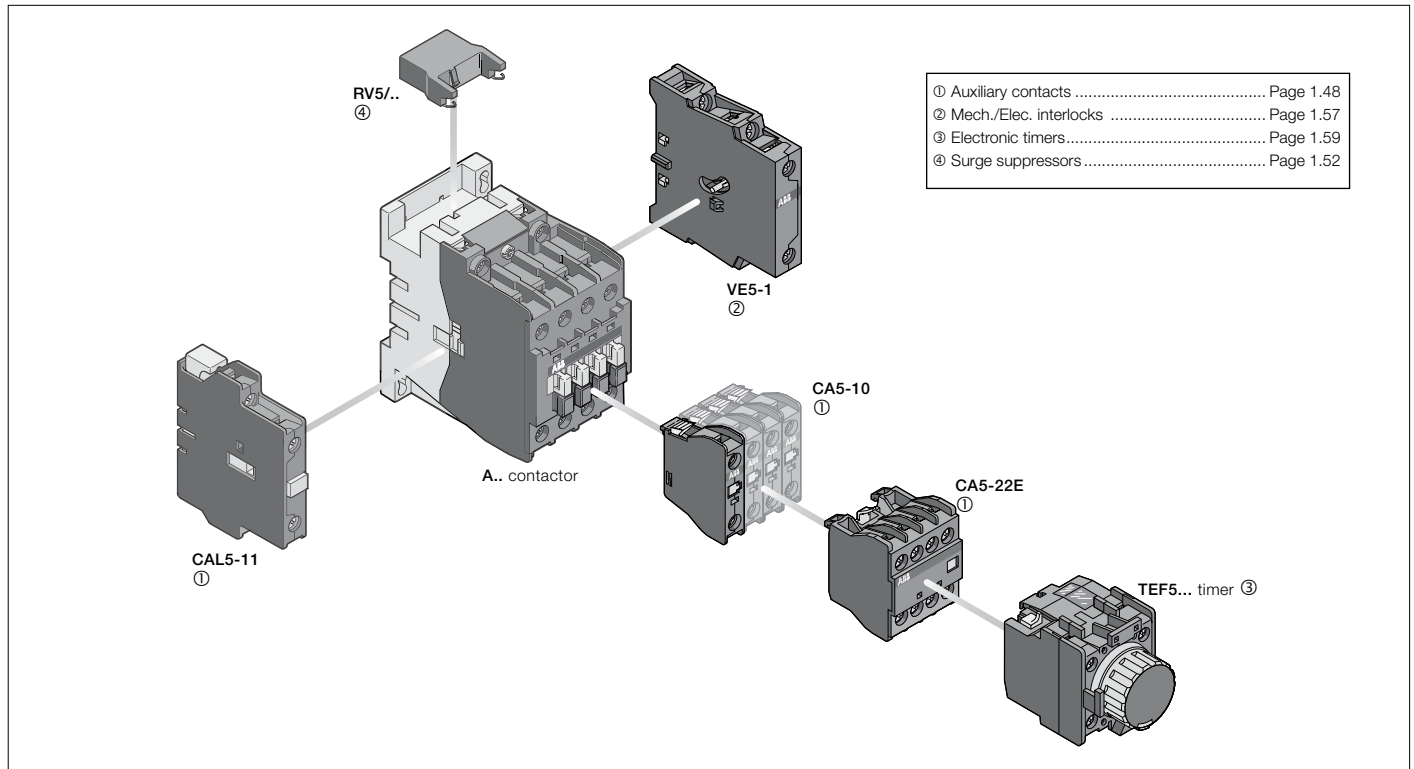

Main accessory fitting details

Many configurations of accessories are possible depending on whether these are front-mounted or side-mounted.

Contactor types	Main poles	Available auxiliary contacts	Front-mounted accessories		Electronic timer	Side-mounted accessories	
			Auxiliary contact blocks			Auxiliary contact blocks	Interlock unit
			1-pole CA5-..	4-pole CA5-..	TP. A	2-pole CAL5-11	VE5-..
A45 ... A75	4 0 0 0		1 to 6 x CA5-..	or 1 x CA5-.. (4-pole) + 2 x 1-pole CA5-..	or 1 x TEF5... + 2 x CA5-.. (1-pole)	+ 1 to 2 x CAL5-11	or 1 x VE5-2 + 1 x CAL5-11
	2 2 0 0 (1)		1 to 6 x CA5-..	or 1 x CA5-.. (4-pole) + 2 x 1-pole CA5-..	or 1 x TEF5... + 2 x CA5-.. (1-pole)	+ 1 to 2 x CAL5-11	-
AE45 ... AE75	4 0 0 0		1 to 6 x CA5-..	or 1 x CA5-.. (4-pole) + 2 x 1-pole CA5-..	or 1 x TEF5... + 2 x CA5-.. (1-pole)	+ 1 x CAL5-11	or 1 x VE5-2
	2 2 0 0 (1)		1 to 6 x CA5-..	or 1 x CA5-.. (4-pole) + 2 x 1-pole CA5-..	or 1 x TEF5... + 2 x CA5-.. (1-pole)	+ 1 x CAL5-11	-
AF50 ... AF75	4 0 0 0		1 to 6 x CA5-..	or 1 x CA5-.. (4-pole) + 2 x 1-pole CA5-..	or 1 x TEF5... + 2 x CA5-.. (1-pole)	+ 1 to 2 x CAL5-11	or 1 x VE5-2 + 1 x CAL5-11
	2 2 0 0 (1)		1 to 6 x CA5-..	or 1 x CA5-.. (4-pole) + 2 x 1-pole CA5-..	or 1 x TEF5... + 2 x CA5-.. (1-pole)	+ 1 to 2 x CAL5-11	-

(1) 2 x N.C. CA 5-.. auxiliary contacts maximum.

EK110... EK1000, 4-pole Accessory fitting details

Main accessory fitting details

Mounting positions of the auxiliary contact

Auxiliary contact types and connecting diagrams

(1) Contact 35-36 used for some types of EK... contactors

Auxiliary contacts..... Page 1.48

EK... 4-pole contactors

Contactor types	Main poles	Available auxiliary contacts	Add-on auxiliary contact blocks	Mounting and positioning
			2-pole CAL16-11 ...	Factory mounted auxiliary contacts Add-on CAL16-11 auxiliary contacts
AC operated, 50 Hz, 60 Hz or 50/60 Hz				
EK110 ... EK1000	4	0 1 1	+ 1 x CAL16-11B + 1 x CAL16-11C + 1 x CAL16-11D	
AC operated, 40...400 Hz				
EK110 ... EK210	4	0 2 1	+ 1 x CAL16-11C	
DC operated				
EK110 ... EK1000	4	0 2 1	+ 1 x CAL16-11C	

EK ... 4-pole reversing contactors with VH... mechanical and electrical interlock units

"Left hand" contactors	Interlocking	"Right hand" contactors	Add-on auxiliary contact blocks	Mounting and positioning
			2-pole CAL16-11 ...	Factory mounted auxiliary contacts Add-on CAL16-11 auxiliary contacts
AC operated, 50 Hz, 60 Hz or 50/60 Hz				
EK110 ... EK150 EK175, EK210 EK370 ... EK1000	VH145 VH300 VH800	EK110, EK150 EK175, EK210 EK370 ... EK1000	+ 1 x CAL16-11C + 1 x CAL16-11D	
AC operated, 40...400 Hz				
EK110 ... EK150 EK175, EK210 EK370 ... EK1000	VH145 VH300 VH800	EK110, EK150 EK175, EK210 EK370 ... EK1000	-	
DC operated, 50 Hz, 60 Hz or 50/60 Hz				
EK110 ... EK150 EK175, EK210 EK370 ... EK1000	VH145 VH300 VH800	EK110, EK150 EK175, EK210 EK370 ... EK1000	-	

A motor starter is typically made up of a switching device (contactor) and an overload protection device (see opposite page "Basic functions").

These two devices **must** be coordinated with an equipment capable of providing protection against short circuit (SCPD: Short-Circuit Protection Device).

A complete data base of coordination tables, according to [IEC 60947-4-1](#) (EN 60947-4-1) or [UL 508 / UL 60947-4-1](#), is available on the ABB Website: see below.

Selection

Coordination tables for motor protection (v. 1.8.8.1637 - venerdì, 26 dicembre 2011 17:37:50)

Selected Optimized Coordination
→ Selection

Clear selection

Protection Device	Rated Voltage [V]	Short Circuit Current [kA]	Starter Type	Coordination type	Motor Rated Power [kW]/[HP]
All	All	42	All	All	Overview
ACB	240	45	DOL-NS	IEC Type 1	0,06
Fuses	400	50	DOL-HD	IEC Type 2	0,09
MCB	415	55	SD-NS	UL Component	0,12
MCCB	440	60	SS-NS-IL	UL Type A	0,18
MMS	460	65	SS-NS-ID	UL Type B	0,25
	480	70	UL	UL Type C	0,37
	500	75		UL Type D	0,5
	525	80		UL Type E	0,55
	600	85		UL Type F	0,75
	690	100			1
		200			1,1

Result 8 records. (0,17 seconds) Enable Smart Current Search: | Number of Records to show: 20

Short-circuit protection devices

- Air circuit breakers
- Fuses
- Miniature circuit breaker
- Moulded case circuit breaker
- Manual motor starter

Starter type

- Direct-on-line normal start
- Direct-on-line heavy duty
- Star-delta normal start
- Soft starter normal start

Coordination

- IEC type 1 or type 2
- UL type A to Type F

Results

- Search results displayed at the bottom of the selection page.
- Only the most appropriate solutions to your application, will be displayed at the bottom of the page.
"Enable Smart Current Search" function featured for the short-circuit current where "near to" selected values also are included in the result.
- Possible to print the page to a pdf file or from your printer.
- "Clear selection" function to deselect all selected.

Fuses, 400 V, 80 kA, DOL-NS, Coordination type IEC Type 2									
Motor		Fuses IEC			Contactor	Overload Relay		Max allowed load current	
Rated Power [kW]	Rated Current [A]	Switch-Fuse Type	Rating gG / aM [A]	Type and Size	Type	Type	Current setting range [A]	Table	
0,37	1,1	OS32D_	2	OFAM 00aM	A9	E16DU2.7 10 *	0,90 - 2,70	1,4	>>
0,37	1,1	OS32D_	2	OFAM 00aM	A9	TA25DU 1,4	1,00 - 1,40	1,4	>>
0,37	1,1	OS32D_	2	OFAM 00aM	A9	UMC22/100 10 *	0,24 - 63,00	1,4	>>
0,37	1,1	OS32D_	4	OFAA 00H	A9	UMC22/100 10 *	0,24 - 63,00	1,3	>>
0,37	1,1	OS32D_	4	OFAA 00H	A9	E16DU2.7 10 *	0,90 - 2,70	1,3	>>
0,37	1,1	OS32D_	4	OFAA 00H	A9	TA25DU 1,4	1,00 - 1,40	1,4	>>

Fuses, 400 V, 80 kA, DOL-NS, Coordination type IEC Type 2, Overload Relay TOL									
Motor		Fuses IEC			Contactor	Overload Relay		Max allowed load current	
Rated Power [kW]	Rated Current [A]	Switch-Fuse Type	Rating gG / aM [A]	Type and Size	Type	Type	Current setting range [A]	Table	
0,25	0,85	OS32GD_	2	OFAF 000aM	AF09	TF42-1,0	0,74 - 1,00	1	>>
0,12	0,44	OS32GD_	2	OFAF 000H	AF09	TF42-0,55	0,42 - 0,55	0,55	>>

Access

To find the coordination tables for motor protection, please see:
www.abb.com/lowvoltage then go to the right menu: "Support", select: "Online Product Selection Tools" then select "Coordination Tables for motor protection"

Auxiliary contact blocks

AF09(Z)...AF38(Z); AF09N00(Z)...AF26N1(Z)



CA4-10



CAL4-11



CA4-22M



CAT4-11E

Ordering details (1)

For contactors	Auxiliary contacts		Catalog number

Front-mounted instantaneous auxiliary contact blocks

AF09 ... AF38 4-pole NF	1 0	- -	CA4-10
	0 1	- -	CA4-01
AF09 ... AF16...-30-10	2 2	- -	CA4-22M
	3 1	- -	CA4-31M
	1 3	- -	CA4-13M
	0 4	- -	CA4-04M
AF26 ... AF38...-30-00	2 2	- -	CA4-22E
AF09 ... AF38...-40-00	3 1	- -	CA4-31E
AF09 ... AF38...-22-00	4 0	- -	CA4-40E
AF26 ... AF38...-30-00	0 4	- -	CA4-04E
AF09 ... AF16...-40-00	2 2	- -	CA4-22U
	3 1	- -	CA4-31U
	4 0	- -	CA4-40U
4-pole NF	4 0	- -	CA4-40N
	3 1	- -	CA4-31N
	2 2	- -	CA4-22N
	1 3	- -	CA4-13N
NF..40E	0 4	- -	CA4-04N

Front-mounted auxiliary contact blocks with N.O. leading contact and N.C. lagging contact

AF09 ... AF38	- -	1 0	CC4-10
4-pole NF	- -	0 1	CC4-01

Side-mounted instantaneous auxiliary contact blocks

AF09 ... AF38, NF	1 1	- -	CAL4-11
-------------------	-----	-----	---------

Front-mounted instantaneous auxiliary contact and A1/A2 coil terminal blocks

AF09 ... AF16...-30-10	1 1	- -	CAT4-11M
AF26 ... AF38...-30-00	1 1	- -	CAT4-11E
AF09 ... AF38...-40-00			
AF09 ... AF38...-22-00			
AF09 ... AF16...-30-01	1 1	- -	CAT4-11U





(1) For each contactor or contactor relay type, refer to "Accessory fitting details" table.

Note: CAT4 not fittable on AF..Z contactors with DC control voltage 12...20 V DC.
Auxiliary contacts same for AF...Z contactors

Auxiliary contact blocks

AF09(Z)... AF38(Z); AF09N00(Z)...AF26N1(Z)

Technical data

Types	1-pole CA4, 1-pole CC4, 4-pole CA4, 2-pole CAT4, 2-pole CAL4	
Contact utilization characteristics according to IEC		
Standards	IEC 60947-5-1 and EN 60947-5-1	
Rated insulation voltage U_i acc. to IEC 60947-5-1	690 V	
Rated impulse withstand voltage U_{imp}	6 kV	
Rated operational voltage U_e max.	24...690 V	
Conventional thermal current I_{th} - $\theta \leq 40$ °C	16 A	
Rated frequency limits	25...400 Hz	
I_e / Rated operational current AC-15	24-127 V 50/60 Hz	6 A
acc. to IEC 60947-5-1	220-240 V 50/60 Hz	4 A
	400-440 V 50/60 Hz	3 A
	500 V 50/60 Hz	2 A
	690 V 50/60 Hz	2 A
Making capacity acc. to IEC 60947-5-1	10 x I_e AC-15	
Breaking capacity acc. to IEC 60947-5-1	10 x I_e AC-15	
I_e / Rated operational current DC-13	24 V DC	6 A / 144 W
	48 V DC	2.8 A / 134 W
	72 V DC	1 A / 72 W
	110 V DC	0.55 A / 60 W
	125 V DC	0.55 A / 69 W
	220 V DC	0.27 A / 60 W
	250 V DC	0.27 A / 68 W
	400 V DC	0.15 A / 60 W
	500 V DC	0.13 A / 65 W
	600 V DC	0.1 A / 60 W
Short-circuit protection device gG type fuse	10 A	
Rated short-time withstand current I_{sw} $\theta = 40$ °C	for 1.0 s	100 A
	for 0.1 s	140 A
Minimum switching capacity	12 V / 3 mA	
with failure rate acc. to IEC 60947-5-4	10 ⁻⁷	
Heat dissipation per pole at 6 A	0.1 W	
Mechanical durability Number of operating cycles	10 million operating cycles	
Max. switching frequency	3600 cycles/h	
Max. electrical switching frequency	AC-15	1200 cycles/h
	DC-13	900 cycles/h
Mechanically linked contact acc. to annex L of IEC 60947-5-1	Yes for N.O. and N.C. contacts	
Mirror contacts acc. to annex F of IEC 60947-4-1	Yes for N.C. contacts	
Contact utilization characteristics according to UL / CSA		
Standards	UL 508, CSA C22.2 N°14	
Max. operational voltage	600 V AC, 600 V DC	
Pilot duty	A600, Q600	
AC thermal rated current	10 A	
AC maximum volt-ampere making	7200 VA	
AC maximum volt-ampere breaking	720 VA	
DC thermal rated current	2.5 A	
DC maximum volt-ampere making-breaking	69 VA	
Connecting characteristics		
Screw terminals (Delivered in open position, screws of unused terminals must be tightened)		
All terminals	M3.5	
Connection capacity (min...max.)		
 Rigid solid	1 x	1...2.5 mm ²
	2 x	1...2.5 mm ²
 Flexible with non insulated ferrule	1 x	0.75...2.5 mm ²
	2 x	0.75...2.5 mm ²
 Flexible with insulated ferrule	1 x	0.75...2.5 mm ²
	2 x	0.75...1.5 mm ²
 Lug	$L \leq$	8 mm
	$L >$	-
Connection capacity acc. to UL / CSA	1 or 2 x	AWG 18...14, solid / stranded
Stripping length	10 mm	
Degree of protection	IP20	
acc. to IEC 60947-1 / EN 60947-1 and IEC 60529 / EN 60529		
Screwdriver type	Flat Ø 5.5 / Pozidriv 2	
Tightening torque	1.2 Nm / 11 lb.in	

Auxiliary contact blocks

A/E/L9...A/E/L40; A/E/F50...AF2050; A/E/F50N2... AF1650N8



CA5-10

Ordering details

For contactors	Number of blocks (1)	Auxiliary contacts				Catalog number

Front-mounted instantaneous auxiliary contact blocks, 1-pole

For contactors	Number of blocks (1)					Catalog number
A9...A40, T/AL9...T/AL40	1-5	1	0	-	-	CA5-10
A45 ... A110	1-6	0	1	-	-	CA5-01
AF45, AF110	1-6	-	-	1	0	CC5-10
AE45 ... AE75, TAE45 ... TAE75	1-6	-	-	0	1	CC5-01



CA5-40E

Front-mounted instantaneous auxiliary contact blocks, 4-pole

For contactors	Number of blocks (1)					Catalog number
A45 ... A110	1	4	0	-	-	CA5-40E
AE45 ... AE75		3	1	-	-	CA5-31E
AF45 ... AF110		2	2	-	-	CA5-22E
TAE45 ... TAE75		0	4	-	-	CA5-04E
		1	1	1	1	CA5-11/11E
A40-30-10	1	3	1	-	-	CA5-31M
AL40-30-10		2	2	-	-	CA5-22M
TAL40-30-10		1	3	-	-	CA5-13M
		0	4	-	-	CA5-04M
		1	1	1	1	CA5-11/11M
A40-30-10	1	4	0	-	-	CA5-40U
AL40-30-10		3	1	-	-	CA5-31U
TAL40-30-10		2	2	-	-	CA5-22U
		0	4	-	-	CA5-04U



CAL5-11

Side-mounted instantaneous auxiliary contact blocks, 2-pole

For contactors	Number of blocks (1)					Catalog number
A9...A75	1-2	1	1	-	-	CAL5-11
T/AL9...T/AL40	1					
AE9...T/AE75	1					
AF45 ... AF75	1-2					
UA16 ... UA75	1-2					
A95 ... A300	1-2	1	1	-	-	CAL18-11
AF95 ... AF2050						
UA95, UA110						
A145 ... A300	1-2(2)	1	1	-	-	CAL18-11B
AF145 ... AF2050		1	1	-	-	

(1) For each contactor type, refer to "Accessory fitting details" table.

(2) 2 blocks CAL18-11 + 2 blocks CAL18-11B.

Note:

- The front-mounted auxiliary contact blocks provided for the A... contactors can be used for the UA..., GA... and GAE... types
- The CAL... auxiliary contact blocks can be used for GA... contactors:
 - GA75-10-00: 2 x CAL5-11 blocks
 - GA75-10-11: 1 x CAL5-11 block
 - GAE75-10-00: 1 x CAL5-11 block
 - GAE75-10-11: no add-on block.
- The CAL... auxiliary contact blocks can be used for UA..RA contactors. See "Accessory fitting details" for this contactor type.



CAL18-11







Low-energy side-mounted contact blocks, 1-pole

For contactors	Number of blocks (1)					Catalog number
A145...A300	1-2	1	0	-	-	CEL18-10
AF145...AF2050	1-2	0	1	-	-	CEL18-01

Auxiliary contact blocks

A/E/L9...A/E/L40; A/E/F50...AF2050; A/E/F50N2...AF1650N8

Technical data

Types	1-pole CA5, 4-pole CA5, 1-pole CC5, 2-pole CAL5	2-pole CAL18	1-pole CEL18
Contact utilization characteristics according to IEC			
Standards	IEC 60947-5-1 and EN 60947-5-1		
Rated insulation voltage U_i acc. to IEC 60947-5-1	690 V		250 V
Rated impulse withstand voltage U_{imp}	6 kV		-
Rated operational voltage U_e max.	24...690 V		125 V
Conventional thermal current $I_{th} - \theta \leq 40^\circ\text{C}$	16 A		0.1
Rated frequency limits	Consult factory		
I_e / Rated operational current AC-15	24-127 V 50/60 Hz	6 A	0.1 A (AC-14)
acc. to IEC 60947-5-1	220-240 V 50/60 Hz	4 A	-
	400-440 V 50/60 Hz	3 A	-
	500 V 50/60 Hz	2 A	-
	690 V 50/60 Hz	2 A	-
Making capacity acc. to IEC 60947-5-1		10 x I_e AC-15	10 x I_e AC-14
Breaking capacity acc. to IEC 60947-5-1		10 x I_e AC-15	10 x I_e AC-14
I_e / Rated operational current DC-13	24 V DC	6 A / 144 W	0.1 A (DC-12)
acc. to IEC 60947-5-1	48 V DC	2.8 A / 134 W	0.1 A (DC-12)
	72 V DC	1 A / 72 W	0.1 A (DC-12)
	110 V DC	0.55 A / 60 W	0.1 A (DC-12)
	125 V DC	0.55 A / 69 W	-
	220 V DC	0.27 A / 60 W	-
	250 V DC	0.27 A / 68 W	-
Short-circuit protection device gG type fuse		10 A	0.1 (FF type HRC fuses)
Rated short-time withstand current I_{cw}	for 1.0 s	100 A	-
$\theta = 40^\circ\text{C}$	for 0.1 s	140 A	-
Minimum switching capacity		17 V / 1 mA (24 V / 50 mA for A/F95...110)	24 V / 50 mA (0.5M of operating cycles)
with failure rate acc. to IEC 60947-5-4		10 ⁻⁷	-
Heat dissipation per pole at 6 A		0.1 W	0.15 W
Mechanical durability Number of operating cycles		10 million (3M for A/F95...110)	"5M (A/F95...185), 3M (A/F210...750), 0.5M (AF1350...2050)"
Max. switching frequency		3600 cycles/h	1200 cycles per hour
Max. electrical switching frequency	AC-15	1200 cycles/h	1200 cycles per hour (AC-14)
	DC-13	900 cycles/h	-
Mechanically linked contact acc. to annex L of IEC 60947-5-1		Yes for N.O. and N.C. contacts	-
Mirror contacts acc. to annex F of IEC 60947-4-1		Yes for N.C. contacts	-
Contact utilization characteristics according to UL / CSA			
Standards	UL 508, CSA C22.2 N°14		
Max. operational voltage	600 V AC, 250 V DC		125 V AC, 24 V DC
Pilot duty	A600, Q300		0.1 A (AC), 5 mA (DC)
AC thermal rated current	10 A		0.1 A
AC maximum volt-ampere making	7200 VA		12.5 VA
AC maximum volt-ampere breaking	720 VA		12.5 VA
DC thermal rated current	2.5 A		5 mA
DC maximum volt-ampere making-breaking	69 VA		1.2 VA
Connecting characteristics			
Screw terminals (Delivered in open position, screws of unused terminals must be tightened)			
All terminals	M3.5		
Connection capacity (min...max)			
 Rigid solid	1 x	1...4 mm ²	
 Rigid solid	2 x	1...4 mm ²	
 Flexible with non insulated ferrule	1 x	0.75...2.5 mm ²	
 Flexible with non insulated ferrule	2 x	0.75...2.5 mm ²	
 Flexible with insulated ferrule	1 x	-	
 Flexible with insulated ferrule	2 x	-	
 Lugs	L ≤	8 mm	
	I >	3.7 mm	
Connection capacity acc. to UL / CSA	1 or 2 x	AWG 18...12, solid / stranded	
Stripping length	10 mm		
Degree of protection	IP20		
acc. to IEC 60947-1 / EN 60947-1 and IEC 60529 / EN 60529			
Screwdriver type	Flat Ø 5.5 / Pozidriv 2		
Tightening torque	1 Nm / 9 lb.in		

Auxiliary contact blocks

(M)AS/L09...(M)AS/L16; (M)B/C6...(M)B/C7; EK

Ordering details



CA3-10

For contactors	For contactor relays	Contact blocks	Catalog number

1-pole auxiliary contact blocks with screw terminals

AS09 ... AS16	NS, NSL	1 -	CA3-10
ASL09 ... ASL16		- 1	CA3-01



CA3-10S

For contactors	For contactor relays	Contact blocks	Catalog number

1-pole auxiliary contact blocks with spring terminals

AS09..S ... AS16..S	NS..S, NSL..S	1 -	CA3-10S
ASL09..S ... ASL16..S		- 1	CA3-01S

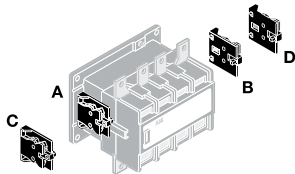

Mounting positions
of the CAL16-11

For contactors	Number of blocks	Auxiliary contacts	Catalog number

2-pole auxiliary contacts N.O. + N.C.

EK	1	1 1 - -	CAL16-11A
	1	1 1 - -	CAL16-11B
	1	1 1 - -	CAL16-11C
	1	1 1 - -	CAL16-11D
	1	1 - - 1	CCL16-11E (1)

(1) Mounting of CCL16-11E blocks does not allow an additional second block to be added on top of it.

All DC operated EK... contactors are equipped with one CCL16-11E on the right side.



CA6-11E

For contactors	Auxiliary contacts	Catalog number

Front-mounted instantaneous auxiliary contact blocks (not allowed for mounting on TBC, B6S, B7S, interface contactors) ¹⁾

B6-, B7-40-00, BC6-, BC7-40-00	1 1	CAF6-11E
VB6, VB7, VBC6, VBC7, VB6A, VB7A	2 0	CAF6-20E
VBC6A, VBC7A	0 2	CAF6-02E
B6-, B7-30-10, BC6-, BC7-30-10	1 1	CAF6-11M
VB6, VB7, VBC6, VBC7, VB6A, VB7A	2 0	CAF6-20M
VBC6A, VBC7A	0 2	CAF6-02M
B6-, B7-30-01, BC6-, BC7-30-01	1 1	CAF6-11N
VB6, VB7, VBC6, VBC7, VB6A, VB7A	2 0	CAF6-20N
VBC6A, VBC7A	0 2	CAF6-02N

Side-mounted instantaneous auxiliary contact block ¹⁾

B6-, B7-40-00, BC6-, BC7-40-00	1 1	CA6-11E
B6-, B7-30-10, BC6-, BC7-30-10	1 1	CA6-11M
B6-, B7-30-01, BC6-, BC7-30-01	1 1	CA6-11N

Side-mounted instantaneous auxiliary contact block with soldering pins ¹⁾

B6-, B7-40-00-P, BC6-, BC7-40-00-P	1 1	CA6-11E-P
B6-, B7-30-10-P, BC6-, BC7-30-10-P	1 1	CA6-11M-P
B6-, B7-30-01-P, BC6-, BC7-30-01-P	1 1	CA6-11N-P







CA6-11E-P

Auxiliary contact blocks

(M)AS/L09...(M)AS/L16

Technical data

Types	1-pole CA3	1-pole CA3...S
Contact utilization characteristics according to IEC		
Standards	IEC 60947-5-1 and EN 60947-5-1	
Rated insulation voltage U_i acc. to IEC 60947-5-1	690 V	
Rated impulse withstand voltage U_{imp}	6 kV	
Rated operational voltage U_e max.	690 V	
Conventional thermal current I_{th} - $\theta \leq 40$ °C	10 A	
Rated frequency limits	25...400 Hz	
I_e / Rated operational current AC-15	24-127 V 50/60 Hz	6 A
acc. to IEC 60947-5-1	220-240 V 50/60 Hz	4 A
	400-440 V 50/60 Hz	3 A
	500 V 50/60 Hz	2 A
	690 V 50/60 Hz	2 A
Making capacity acc. to IEC 60947-5-1	10 x I_e AC-15	
Breaking capacity acc. to IEC 60947-5-1	10 x I_e AC-15	
I_e / Rated operational current DC-13	24 V DC	6 A / 144 W
acc. to IEC 60947-5-1	48 V DC	2.8 A / 134 W
	72 V DC	1 A / 72 W
	110 V DC	0.55 A / 60 W
	125 V DC	0.55 A / 69 W
	220 V DC	0.27 A / 60 W
	250 V DC	0.27 A / 68 W
	400 V DC	-
	500 V DC	-
	600 V DC	-
Short-circuit protection device gG type fuse	10 A	
Rated short-time withstand current I_{sc}	for 1.0 s	100 A
$\theta = 40$ °C	for 0.1 s	140 A
Minimum switching capacity	12 V / 3 mA	
with failure rate acc. to IEC 60947-5-4	10 ⁻⁷	
Heat dissipation per pole at 6 A	0.1 W	
Mechanical durability Number of operating cycles	10 million operating cycles	
Max. switching frequency	3600 cycles/h	
Max. electrical switching frequency	AC-15	1200 cycles/h
	DC-13	900 cycles/h
Mechanically linked contact acc. to annex L of IEC 60947-5-1	Yes for N.O. and N.C. contacts	
Mirror contacts acc. to annex F of IEC 60947-4-1	Yes for N.C. contacts	
Contact utilization characteristics according to UL / CSA		
Standards	UL 508, CSA C22.2 N°14	
Max. operational voltage	600 V AC, 250 V DC	
Pilot duty	A600, Q300	
AC thermal rated current	10 A	
AC maximum volt-ampere making	7200 VA	
AC maximum volt-ampere breaking	720 VA	
DC thermal rated current	2.5 A	
DC maximum volt-ampere making-breaking	69 VA	
Connecting characteristics		
Screw terminals (Delivered in open position, screws of unused terminals must be tightened)		
All terminals	M3	N/a - Spring terminals
Connection capacity (min...max.)	0.75...2.5 mm ²	
 Rigid solid	1 x	
 Rigid solid	2 x	0.75...2.5 mm ²
 Flexible with non insulated ferrule	1 x	0.75...2.5 mm ²
 Flexible with non insulated ferrule	2 x	0.75...2.5 mm ²
 Flexible with insulated ferrule	1 x	0.75...2.5 mm ² 0.75...1.5 mm ²
 Flexible with insulated ferrule	2 x	0.75...1.5 mm ²
 Lugs	L ≤	7.7 mm
	L >	3.2 mm
Connection capacity acc. to UL / CSA	1 or 2 x	AWG 18...14, solid / stranded
Stripping length	9 mm 10 mm	
Degree of protection	IP20	
acc. to IEC 60947-1 / EN 60947-1 and IEC 60529 / EN 60529		
Screwdriver type	Flat Ø 5.5 / Pozidriv 2	Flat Ø 3.5
Tightening torque	1 Nm / 9 lb.in	-

Surge suppressors for contactor coils

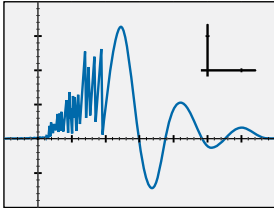

NOTE: AF Series contactors include integral surge suppressor

Description

The operation of inductive circuits causes overvoltages, in particular on opening of the contactor coil.

The electromagnetic energy stored in the coil during contactor closing is restored on opening in the form of surges, the slope and amplitude of which may rise to several kilovolts. A number of drawbacks are observed ranging from interference on the electronic devices to breakdown of insulators and even destruction of certain sensitive components.

The graph opposite reproduces the oscillogram showing voltage discharges at the terminals of a 42 V / 50 Hz coil without peak clipping. The coil was switched by 8 series-connected poles of a contactor relay.

Following a burst of discharges with a very steep slope a damped oscillation emerges with a peak value of 3500 V.

Overvoltage Factor

The overvoltage factor k is defined as the ratio of the maximum overvoltage peak value \hat{U}_s to the peak value \hat{U}_c of the coil rated control voltage U_c :

$$k = \frac{\hat{U}_s \text{ max.}}{\hat{U}_c} \quad \text{in DC: } k = \frac{\hat{U}_s \text{ max.}}{U_c} \quad \text{or in AC: } k = \frac{\hat{U}_s \text{ max.}}{U_c \sqrt{2}}$$

For example the following is obtained for the above graph: $k = \frac{3500}{42 \sqrt{2}} \approx 60$

To reduce the harmful effects of these overvoltages, ABB has developed a range of surge suppressors designed to reduce the k factor defined above and to limit or even completely eliminate the high pre-damping voltage frequencies.

Each case is different, but the technical data tolerances and the generous sizing of parts have enabled us to reduce the number of variants.

We have chosen the following solutions: transil diodes, varistors and RC blocks.

Note: A varistor is a resistor whose value decreases to a very large extent when a certain voltage is applied at its terminals.



RV5



RC5-1



RT5



RC-EH300/48

Ordering details

For contactors	Rated control circuit voltage U_c			Catalog number
	V	AC	DC	
AS09...AS16; A9 ... A110, AL9...AL40, ASL09...ASL16 AE9 ... AE75, TAL9...TAL40, TAE45 ... TAE75	24...50	●	●	RV5/50
	50...133	●	●	RV5/133
	110...250	●	●	RV5/250
	250...440	●	●	RV5/440
AS09...AS16 A9...A40	24...50	●	-	RC5-1/50
	50...133	●	-	RC5-1/133
	110...250	●	-	RC5-1/250
	250...440	●	-	RC5-1/440
A45 ... A110	24...50	●	-	RC5-2/50
	50...133	●	-	RC5-2/133
	110...250	●	-	RC5-2/250
	250...440	●	-	RC5-2/440
A145 ... A300	250...440	●	-	RC5-3/440
AL9...AL40 AE9 ... AE75, TAL9...TAL40, TAE45 ... TAE75 ASL09...ASL16	12...32	-	●	RT5/32
	25...65	-	●	RT5/65
	50...90	-	●	RT5/90
	77...150	-	●	RT5/150
	150...264	-	●	RT5/264
EK110 ... EK210	24...48	●	-	RC-EH300/48
	110...415	●	-	RC-EH300/415
EK370 ... EK1000	48...110	●	-	RC-EH800/110
EK110 ... EK1000	24...125	-	●	RC-EH800/110
EK370 ... EK1000	220...600	●	-	RC-EH800/600

Surge suppressors for contactor coils



RV-BC6/250

For contactors	Rated control circuit voltage U_c V DC	Connection type	Catalog number
BC6, BC7	24 ... 60	Cable lug	RV-BC6/60
		Flat pin, 2.8 mm	RV-BC6-F/60
	50 ... 250	Cable lug	RV-BC6/250
		Flat pin, 2.8 mm	RV-BC6-F/250
	380	Cable lug	RV-BC6/380
		Flat pin, 2.8 mm	RV-BC6-F/380

Surge suppressors for contactor coils

Note: Mini contactors for AC operation have an integrated protective circuit

Technical data

Varistor

	RV5/50	RV5/133	RV5/250	RV5/440
Rated control circuit voltage U_c	24...50 V AC 24...50 V DC	50...133 V AC 50...133 V DC	110...250 V AC 110...250 V DC	250...440 V AC 250...440 V DC
Residual overvoltage (clipping voltage)	132 V AC 132 V DC	270 V AC 270 V DC	480 V AC 480 V DC	825 V AC 825 V DC
Opening time growth factor	none			
Operating temperature	-20...+70 °C			
Advantages	High energy absorption: good damping - Unpolarized system.			
Drawback	Clipping as from U_{vdr}^* , thus voltage front up to this point. * U_{vdr} = Varistor operating voltage (voltage dependent resistor), tolerance $\pm 10\%$.			

RC type

	RC5-1/50	RC5-1/133	RC5-1/250	RC5-1/440
Rated control circuit voltage U_c	24...50 V AC	50...133 V AC	110...250 V AC	250...440 V AC
Residual overvoltage (clipping voltage)	2 to 3 x U_c max.			
Opening time growth factor	2...3			
Operating temperature	-20...+70 °C			
Advantages	Very fast clipping - Attenuation of steep fronts and thus of high frequencies.			

Transil diode

	RT5/32	RT5/65	RT5/90	RT5/150	RT5/264
Rated control circuit voltage U_c	12...32 V DC	25...65 V DC	50...90 V DC	77...150 V DC	150...264 V DC
Residual overvoltage (clipping voltage)	50 V DC	100 V DC	150 V DC	210 V DC	390 V DC
Opening time growth factor	1.1...1.2				
Operating temperature	-20...+70 °C				
Advantages	Good energy absorption - Unpolarized system - Simple, reliable system.				
Drawback	Delay on drop out which does not however reduce contactor breaking capacity.				

Wiring diagrams

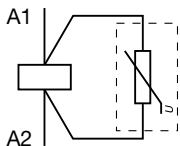

Varistor

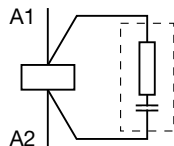

RC type

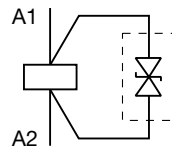

Transil diode

Interface relays A/E/L9...A110

Interface relays

Mounting on contactor types	Control voltage U_c	Coil voltages	Catalog number
N, A9 – A110	24 VDC	24 – 250V, 50, 60 Hz	RA5-1

NOTE: The interface relays provided for the A contactors can also be used for UA, UA..., RA and GA types.

Application

RA 5-1 interface relays are designed to receive 24 VDC signals delivered by PLC's or other sources with a low output power and restore them with sufficient power to operate the coils of the relevant A9 - A110 contactors or the N control relays.

- IEC only

Description

RA5 interface relays are made up of a miniature electromechanical relay equipped with a N.O. contact and with a low consumption 24 VDC coil.

The interface relay coil is controlled by the PLC while the N.O. contact ensures switching of the power contactor.

Coil switching gives rise to overvoltages which have adverse effects on the electronic devices, insulators and, more generally, on component lifetime.

The RA 5-1 is equipped with surge suppressors:

- on the 24 VDC relay coil via a diode
- on the power contactor coil via a varistor.

Furthermore, the RA 5-1 are protected against relay pole reversal by a diode inserted between the E1 and E2 input terminals.

Connection

The "E1+" and "E2-" input terminals must be connected, according to their polarity, to the PLC output.

The RA 5 is equipped with two terminal pads for connection to the A1 and A2 terminals of the contactor coil. This coil is supplied between the A0 and A2 terminals of the RA 5.

Mounting

- RA5: terminal pads clamped inside the contactor coil terminals.



A30-30-10 + RA 5



RA 5

RA 5-1 interface relay for the A 9 – A 110 contactors and N control relays

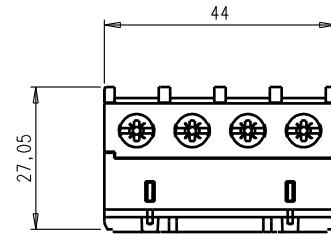
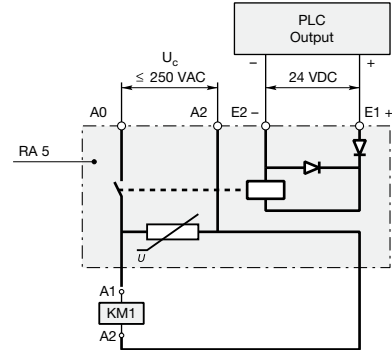

Interface relays

Technical data

General technical data

Compliance with standards		IEC 60255-5
Rated insulation voltage U_i according to IEC 60947-4-1	V a.c.	250
Permissible ambient temperature:		
– for free air operation:		
– at $U_c = 24$ V d.c. (between E1 and E2)	°C	-25 ... +70
– from 0.85 to 1.1 U_c	°C	-25 ... +55
– for storage	°C	-40 ... +70
Climatic withstand		Complies with that of associated contactors
Operating altitude	m	≤ 3000
Mounting position		No limitation
Fixing		Using the contactor A1 and A2 terminal connecting parts
Connecting terminals (delivered in open position)		M3.5 (+,-) pozidriv 2 screws with cable clamp
Connecting capacity (min. ... max.)		
– rigid solid	2 x mm²	1 ... 4
– flexible with cable end	2 x mm²	0.75 ... 2.5
Tightening torque		
– recommended	Nm	1.00
– max.	Nm	1.20
Degree of protection according to IEC 60947-1 / EN 60947-1 and IEC 60529 / EN 60529		Protection against direct contact in acc. with EN 50274 RA5-1 wired and mounted on the associated contactor

Working data

Surge suppression:		
– for contactor coil		Varistor
– for interface relay coil		Diode
Protection against polarity reversal between terminals E1 and E2		Diode
Interface relay operating time	ms	Closing and drop-out ≤ 10
Total operating time, interface relay + contactor:		
– between energization and:		
N.O. contact closing	ms	20 ... 37
N.C. contact opening	ms	17 ... 32
– between de-energization and:		
N.O. contact opening	ms	17 ... 25
N.C. contact closing	ms	20 ... 28

Electrical input data

Control voltage (E1 and E2 terminals) U_c		
– rated value	V d.c.	24
– max. range at ambient temperature 20 °C	V d.c.	19 ... 30
Max. consumption for $U_c = 24$ V d.c., $\theta = 20$ °C	W	0.3
"0" status (relay open) for U_c	V d.c.	≤ 2.4
or I_c	mA	< 1
"1" status (relay closed) for U_c	V d.c.	≥ 19
Max. short supply interruption immunity time	ms	2

Electrical output data

Switching voltage (A0 and A2 terminals)	V a.c.	≤ 250
Electrical durability million of operating cycles		2 (600 cycles/h) on A 9 ... A 75 contactors or N... contactor relay 0.5 (600 cycles/h) on A 95 and A 110 contactors

Mechanical & electrical interlocks

AF09(Z)...AF38(Z), AF09N00(Z)...AF26N1(Z); AS/L09...AS/L16



VM4



VM3

Mechanical interlock unit

For contactors	Catalog number
AF09 ... AF38..-30-..	VM4
AF09 ... AF38..-40-00	VM4
ASL	VM3

Note: Includes two fixing clips.

Mechanical and electrical interlock set

For contactors	Auxiliary contacts	Catalog number
AF09 ... AF16..-30-..		VEM4
AF26 ... AF38..-30-00		
AF09, AF16..-40-00		
AF26, AF38..40-00		

Note: VEM4 not fittable on AF..Z contactors with DC control voltage 12...20 V DC.

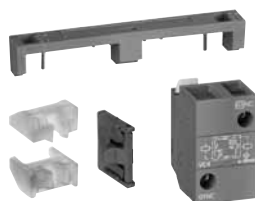

VEM4

Fixing clips

For contactors	Catalog number
AF09 ... AF38	BB4
AS, ASL	BB3

Note: Set of 50 pieces each

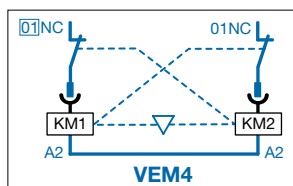

BB4

Mechanical & electrical interlocks

A/E/L9...A/E/L40; A/E/F50...AF2050
A/E/F50N2...AF1650N8; EK



VM300H



VM1650H

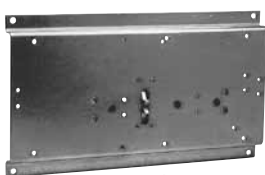

VH800

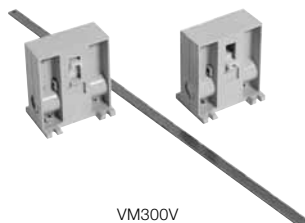

VM300V



VE5-1



VH145

Ordering details (1)

Left side contactor	Right side contactor	Mounting	Catalog number
---------------------	----------------------	----------	----------------

Mechanical interlock units for two horizontal mounted contactors (1)

A9...A40	A9...A40	Rail mounting	VM5-1
A30...A40	A45 ... A110	See table below with VE5-.. type	-
A45 ... A75	A45 ... A110		-
A95 ... A185	A45 ... A110		-
A95 ... A185	A145 ... A300	PN.. mounting plate to be ordered separately	VM300H
A210 ... A300	A145 ... A300		VM300H
A210 ... A300	AF400 ... AF460		VM300/460H
AF400 ... AF1250	AF400 ... AF1250		VM750H
AF1350 ... AF2050	AF1350 ... AF2050	Plate included	VM1650H
EK370...EK1000	EK370...EK1000	Plate included	VH800

(1) Mechanical durability: VM5-1 = 5 millions cycles, VM300H ... VM750H = 1 million cycles.

The interlock units provided for A... contactors can be used for AF types, AE types & AL types.

The interlock units provided for A40.. contactors can be used for AL40.. and TAL40.. types.

Top contactor	Bottom contactor	Mounting	Catalog number
---------------	------------------	----------	----------------

Mechanical interlock units for two vertical mounted contactors (2)

A95 ... A185	A145 ... A300	Additional plate (not supplied)	VM300V
A210 ... A300	A145 ... A300		VM300V
A210 ... A300	AF400 ... AF460		VM300/460V
AF400 ... AF1250	AF400 ... AF1250		VM750V

(2) Mechanical durability: VM300V ... VM750V = 1 million cycles.

Left side contactor	Right side contactor	Mounting	Catalog number
---------------------	----------------------	----------	----------------

Mechanical and electrical interlock units for two horizontal mounted contactors

A9...A40	A9...A40	Rail mounting	VE5-1
A30 ... A75	A45 ... A75		VE5-2
A45 ... A75	A30 ... A75		VE5-2
A45 ... A75	A95 ... A110	PN.. mounting plate to be ordered separately	VE5-2 (3)
A95 ... A110	A45 ... A75		VE5-2 (3)
A95 ... A110	A95 ... A110		VE5-2
EK110, EK150	EK110, EK150		VH145
EK175, EK210	EK110, EK150		VH300

(3) The combination of A45 ... A75 contactors interlocked with A95, A110 contactors cannot be mounted on symmetrical rail (75 mm, IEC/EN 60715).

The interlock units provided for A... contactors can be used for AE, TAE, AF, GA and GAE types.

The interlock units provided for A40.. contactors can be used for AL40.. and TAL40.. types.

Mechanical latching unit

AF(Z), AE & AL



WB75-A

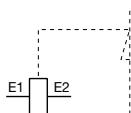

Terminal marking

Description

For converting standard contactors into latched contactors.

The WB75 block contains a mechanical latching device with electromagnetic impulse unlatching (AC or DC) or manual unlatching.

Captive screw type connecting terminals, built-in cable clamps, M3.5 (+, -) pozidriv 2 screw with screw-driver guidance; delivered untightened and protected against accidental direct contact.

Operation

After closing, the contactor continues to be held in the closed position by the latching mechanism should the supply voltage fail at the contactor coil terminals.

Contactor opening can be controlled:

- electrically by an impulse* (AC or DC) on the WB75-A block coil.
 - * the coil is not designed to be permanently energized.
- manually by pressing the pushbutton on the front face of the WB75-A block.

Mounting

The WB75-A block is clipped onto the front face of the 1-stack contactor where it takes up two slots. The two other slots may accept CA5... single pole auxiliary contacts (1 block on each side of the mechanical latch).

Ordering details

For contactors	Rated control circuit voltage U_c		Catalog number
	V 50 Hz or DC	V 60 Hz	
A40 ... A75,	24	24...28	WB75A-01
AF45 ... AF75,	42	42...48	WB75A-02
AL40,	48	48...55	WB75A-03
AE45 ... AE75,	110	110...127	WB75A-04
TAL40,	220...230	220...255	WB75A-06
TAE45 ... TAE75,	230...240	230...277	WB75A-05
UA16 ... UA75,	380...415	380...440	WB75A-07
GA75, GAE75	415...440	440...480	WB75A-08
AF09(Z)...AF38(Z)			
NF, NFZ			

Electronic timers

AF09(Z)...AF38(Z), AS(L)09...AS(L)16, A/E/L40...A/E/F75



TEF3-ON



TEF5

Ordering details

For contactors, contactor relays	Time delay range selected by switch	Delay type	Rated control circuit voltage U_c V 50/60 Hz or DC	Auxiliary contacts		Catalog number
AS/L09...AS/L16, NS(L)	0.1...1 s	ON-delay	24...240	1	1	TEF3-ON
		OFF-delay	24...240	1	1	TEF3-OFF
AF09(Z)...AF38(Z), NF(Z)	1...10 s	ON-delay	24...240	1	1	TEF4-ON
		OFF-delay	24...240	1	1	TEF4-OFF
A/E/L9...A/E/L40, A/E/F45...A/EF75	10...100 s	ON-delay	24...240	1	1	TEF5-ON
		OFF-delay	24...240	1	1	TEF5-OFF

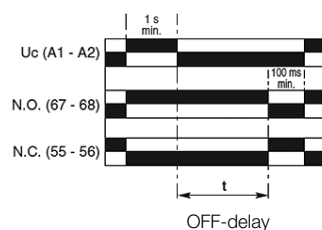
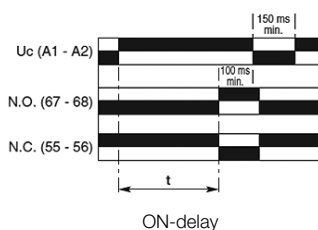

Electronic timers for wye-delta starters

Electronic timer



TE5S-*

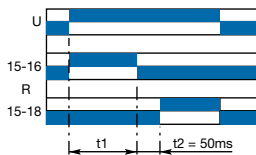

Chart

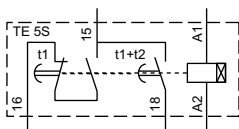

Equivalent diagram

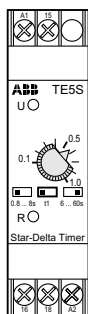

Front face

For contactors	Rated control voltage U_c V	Packing piece	Unit weight kg	Catalog number
A9 – AF750 ①	24 AC/D	1	0.080	TE5S-24
	110 – 120 AC	1	0.080	TE5S-120
	220 – 240 AC	1	0.080	TE5S-240
	380 – 440 AC	1	0.080	TE5S-440

Application

Utilization

When used in wye-delta starters, the **TE5S** lags the wye connection and provides a lapse of 50 ms before the switchover to the delta connection.

Description

According to the type of device chosen, the electronic circuit has a 24 VAC/VDC, 110 – 120 VAC or 220 – 230 VAC supply. An output relay with reversing contact ensures high current switching. A two-position switch allows selection of one of the two time delay ranges: 0.8 to 8 s or 6 to 60 s. The 0.1 to 1.0 adjustable knob allows an initial setting without steps within the previously selected range which can then be adjusted using a stopwatch.

Note: We recommend that you allow for temperature drift for the final adjustment of the time delay setting. Drift: -0.2% per $^{\circ}\text{C}$. For example, a setting made at 20°C will yield a time delay shorter by 7% at 55°C in an enclosure. (-0.2% per $^{\circ}\text{C}$ i.e. $-0.2 \times 35 = -7\%$).

The TE5S, which is not affected by these settings, establishes a fixed “lapse” of 50 ms between the opening of contact 15 – 16 and the closing of contact 15 – 18. It is this time delay that prevents from arc short-circuit during wye to delta switching.

Operation

On energization, the green U indicator light (voltage applied) comes on. Contact 15 – 16 then immediately moves to the closed position.

Count-down of the programmed time immediately commences.

When the time delay has elapsed, contact 15 – 16 opens and at the same time the 50 ms lapse, t_2 , begins after which contact 15 – 18 moves to the closed position. The yellow R indicator light comes on.

On de-energization, the U and R indicator lights go out and, after the 250 ms resetting time, the device is ready for a new cycle.

Mounting

Mounts on 35mm DIN rail.

① Types AF09(Z)...AF38(Z); AF09N00(Z)...AF26N1(Z) and AS/L09...AS/L16 use Type CT-ERS... timers. See Chapter 6.

Electronic timers for wye-delta starters

Technical data

Types	TE5S-24	TE5S-120	TE5S-240	TE5S-440
Compliance with standards	IEC 60947-5-1, EN 60947-5-1			
Rated insulation voltage U_i according to IEC 60947-5-1	V	440		
Rated operational voltage U_e according to IEC 60947-5-1	V d.c. V a.c.	24 24 ... 240		– 440
Conventional free air thermal current I_{th}	A	10		
Rated operational current I_e acc. to IEC 60947-5-1				
AC-15	24-120 V a.c. 220-240 V a.c. 380-440 V a.c.	A A A	5 4 –	– – 3
DC-13	24 V d.c.	A	4	–
Short-circuit protection - gG type fuses	A	10		
Rated supply voltage U_c	V d.c. V a.c.	24 24	– 110 ... 120	– 220 ... 240 380 ... 440
– Rated frequency limits	Hz	48 ... 63		
– Supply voltage range		0.85 ... 1.1 U_c		
– Overvoltage protection		Built-in varistor		
– Load factor	%	100		
– Average consumption	– in d.c. – in a.c.	W VA	0.7 1.5	– 12.5
Time delay range (t_d) selected by switch	s	0.8 ... 8 and 6 ... 60		
– Temperature drift	% per °C	-0.2		
– Mechanical setting accuracy		±15 % of the setting range		
– On-load reiteration accuracy under constant conditions		±2 % after 1 million operating cycles		
Minimum time lapse (t_2)	ms	50		
Min. time lapse after 1 million operating cycles	ms	40		
Resetting time (maximum)	ms	250		
Front panel display:	– green indicator light – yellow indicator light	Energization Output relay activated		
Permissible air temperature				
– for operation	°C	-25 ... +60		
– for storage	°C	-40 ... +85		
Vibration withstand acc. to IEC 60068-2-6, EN 60068-2-6		3 g from 10 to 300 Hz in the 3 directions		
Shock withstand acc. to IEC 60068-2-27, EN 60068-2-27		20 g / 11 ms in directions A and C 15 g / 11 ms in direction B		
Electrical durability	in millions of op. cycles	1		
Mechanical durability	in millions of op. cycles	5		
On-load maximum switching frequency	cycles/h	720		600
Fixing on mounting rail acc. to IEC/EN 60715	35 x 7.5	35 x 15		
Connecting terminals		(+, -) pozidriv 1 screw		
Connecting capacity				
– rigid solid	1 or 2 x mm ²	1 ... 2.5		
– flexible with cable end	1 or 2 x mm ²	0.75 ... 2.5		
Tightening torque	Nm	0.6 ... 0.8 max.		
Degree of protection	Terminals	IP 20		
according to IEC 60947-1 / EN 60947-1 and IEC 60529 / EN 60529				

Connection kits

Reversing and phase-to-phase

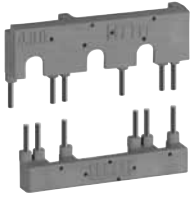

BER16-4

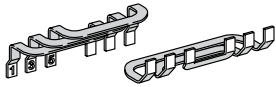

BEM75-30



BEM300-30

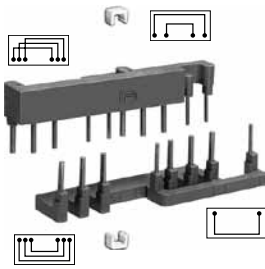

BER16C-3



BES...



BSM6-30

Reversing connection kits for 3-pole contactors

Left side contactor	Right side contactor	Catalog number
AF09(Z)...AF16(Z)	AF09(Z)...AF16(Z)	BER16-4
AF26(Z)...AF38(Z)	AF26(Z)...AF38(Z)	BER38-4
A/E/L9...A/E/L16	A/E/L9...A/E/L16	BER16V
A/E/L26...A/E/L40	A/E/L26...A/E/L40	BER40V
A/E/F50...A/E/F75	A/E/F50...A/E/F75	BEM75-30
A/F95...A/F110	A/F95...A/F110	BEM110-30
A/F145...A/F185	A/F145...A/F185	BEM185-30
A/F210...A/F300	A/F210...A/F300	BEMA300-30
AF400...AF460	AF400...AF460	BEM460-30
AF580...AF750	AF580...AF750	BEM750-30
AS/L09...AS/L16	AS/L09...AS/L16	BER16C-3
VB/C6...VB/C7	-	BSM6-30

Phase-to-phase connection kits for 3-pole contactors

Left side contactor	Right side contactor	Catalog number
A/E/F50...A/E/F75	A/E/F50...A/E/F75	BES75-30
A/F95...A/F110	A/F95...A/F110	BES110-30
A/F145...A/F185	A/F145...A/F185	BES185-30
A/F210...A/F300	A/F210...A/F300	BESA300-30
AF400...AF460	AF400...AF460	BES460-30
AF580...AF750	AF580...AF750	BES750-30

Phase-to-phase connection kits for 4-pole contactors

Left side contactor	Right side contactor	Catalog number
A/E/F45...A/E/F75	A/E/F45...A/E/F75	BES75-40

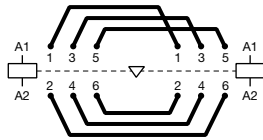

BER, BEM connection sets

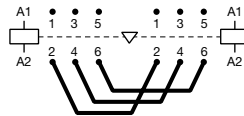

BES... for 3-pole connections

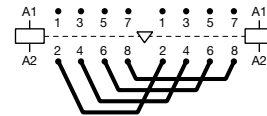

BES... for 4 N.O. main pole connections

Connection sets

Wye-delta

Wye-delta connection kits for 3-pole contactors

Line contactor 1M	Delta contactor 2M	Shorting (wye) contactor 1S	Mechanical / electrical interlock between 2M-1S	Catalog number
AF09(Z)-30	AF09(Z)-30	AF09(Z)-30	VM4 / VEM4 ①	BEY16-4
AF12(Z)-30	AF12(Z)-30	AF09(Z)-30		
AF16(Z)-30	AF16(Z)-30	AF09(Z)-30		
AF26(Z)-30	AF26(Z)-30	AF26(Z)-30		
AF30(Z)-30	AF30(Z)-30	AF26(Z)-30	VM4 / VEM4 ①	BEY38-4
AF38(Z)-30	AF38(Z)-30	AF26(Z)-30		
AS/L09-30	AS/L09-30	AS/L09-30	VM3 ①	BEY16C-3
AS/L12-30	AS/L12-30	AS/L09-30		
AS/L16-30	AS/L16-30	AS/L12-30		
A/E/L9-30	A/E/L9-30	A/E/L9-30		
A/E/L12-30	A/E/L12-30	A/E/L9-30	VE5-1	BEY16V-2
A/E/L16-30	A/E/L16-30	A/E/L12-30		
A/E/L26-30	A/E/L26-30	A/E/L16-30	VE5-1	BEY26-2
A/E/L30-30	A/E/L30-30	A/E/L26-30		
A/E/L40-30	A/E/L40-30	A/E/L26-30	VE5-1	BEY40-2
A/E/F50-30	A/E/F50-30	A/E/L30-30		
A/E/F63-30	A/E/F63-30	A/E/L40-30	VE5-2	BED50U
A/E/F75-30	A/E/F75-30	A/E/F50-30		
A/F95-30	A/F95-30	A/E/F75-30	VE5-2	BED95U
A/F110-30	A/F110-30	A/F95-30		
A/F145-30	A/F145-30	A/F110-30	VM300H	BED145U
A/F185-30	A/F185-30	A/F145-30		
A/F210-30	A/F210-30	A/F185-30	VM300H	BED210U
A/F260-30	A/F260-30	A/F210-30		
A/F300-30	A/F300-30	A/F260-30	VM300H	BED300U
AF400-30	AF400-30	A/F260-30		
AF460-30	AF460-30	A/F300-30	VM300/460H	BED400U
		AF400-30		
AF580-30	AF580-30	AF400-30	VM750H	BED460U
		AF460-30		
AF750-30	AF750-30	AF580-30	VM750H	BED580U
			VM750H	BED750U

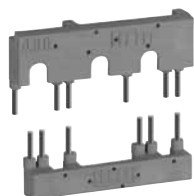

BEY16-4



BEY16C-3

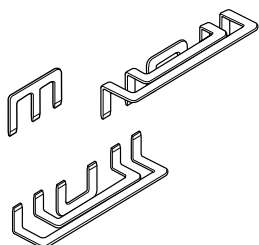

BED 110

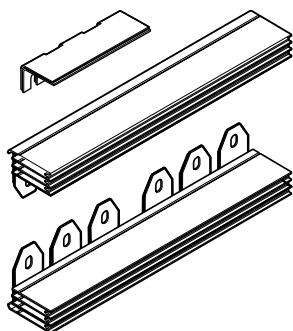

BED 400

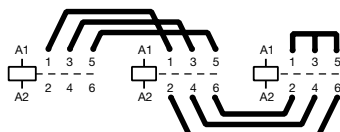

BEY / BED connection kits

① Mechanical/electrical interlock optional.

Coupling units Manual motor protectors

Close couplers for contactors

	Miniature contactors		AF contactors					AS contactors		A / AE Contactors		Catalog number
	B6...B7	BC6...BC7	AF09...AF16	AF09Z...AF16Z	AF26...AF38	AF26Z...AF38Z	AF50...AF75	AF95...AF110	AS09...AS16	ASL09...ASL16	A50...A75, AE50...AE75	
Manual motor protector	•	•										
MS116-0.16...16			•	•	•	•			•	•		
MS116-20...25			•	•	•	•						
MS116-32					•	•						
MS132-0.16...10	•	•	•	•	•	•						
MS132-12...16	•	•	•	•	•	•			•	•		
MS132-20...25			•	•	•	•						
MS132-32					•	•						
MS45x-40...50							•			•		
MS49x-40...100							•			•		
MS495-40...100								•			•	

Note: For spring terminated AS/ASL, use part number BEA16-3U with integral wire leads for spring terminals.



MS132 + AF Contactor



BEA16-4



BEA16-3

Coupling units MCCB/MCP/Fusible disconnects

Ordering details

For contactors	MCCB/MCP	Catalog number
----------------	----------	----------------

Vertical assembly

A145, A185, AF145, AF185	T3	BEA185/T3
A145, A185, AF145, AF185	T4	BEA185/T4
A210, AF210	T4	BEA210/T4
A210 ... A300, AF210 ... AF300	T5	BEA300/T5
AF400 ... AF750	T6	BEA750/T6
AF400 ... AF750	T5	BEA750/T5

Vertical assembly with control wire terminals (also suitable when using busbar kits for starter combinations)

A145, A185, AF145, AF185	T3	BEA185D/T3
A145, A185, AF145, AF185	T4	BEA185D/T4
A210, AF210	T4	BEA210D/T4
A210 ... A300, AF210 ... AF300	T5	BEA300D/T5
AF400 ... AF750	T6	BEA750D/T6
AF400 ... AF750	T5	BEA750D/T5

Horizontal assembly (also suitable when using busbar kits for starter combinations)

A210 ... A300, AF210 ... AF300	T5	BEA300H/T5
AF400, AF460	T4	BEA460H/T4



BEA300



BEA...D

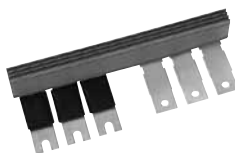

BEA300H



BEF300/OESA400

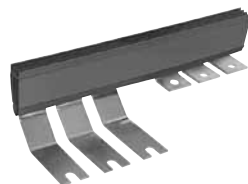

BEF300H/OESA400

Ordering details

For contactors	Switch	Catalog number
----------------	--------	----------------

Vertical assembly

A145 ... A185	OESA250	BEF185/OESA250
A210 ... A300	OESA250 to OESA400	BEF300/OESA400
AF400, AF460	OESA400	BEF460/OESA400
AF460 ... AF750	OESA630 to OESA800	BEF750/OESA800

Horizontal assembly

A145, A185	OESA250...LR	BEF185H/OESA250
A210 ... A300	OESA250...LR to OESA400...LR	BEF300H/OESA400
AF400, AF460	OESA400...LR	BEF460H/OESA400

Note: The BEF... connection bars provided for the A145 ... A300 contactors can be used for the AF145 ... AF300 contactors.

Terminal enlargements/extensions & Shorting bars

LW... Terminal enlargements



LW...

For contactors	Dimensions		Catalog number
	hole Ø mm	bar mm	
A95, A110	6.5	15 x 3	LW110
A145, A185	10.5	20 x 5	LW185
A210 ... A300	10.5	25 x 5	LW300
AF400, AF460	10.5	25 x 5	LW460
AF580, AF750	13	40 x 6	LW750
AF1250	13	50 x 10	LW1250

Note: The LW... pieces provided for the A... contactors can be used for the AF, AE, TAE and UA types.

LX... Terminal extension

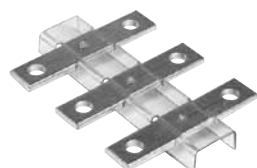

LX...

For contactors	Dimensions		Catalog number
	hole Ø mm	bar mm	
A145, A185	8.5	20 x 5	LX185
A210 ... A300	10.5	20 x 5	LX300
AF400, AF460	10.5	25 x 5	LX460
AF580, AF750	13	40 x 6	LX750

Note: The LX... pieces provided for the A... contactors can be used for the AF types.

Shorting bars



LP185



LY185



LH...



LF...

Poles	For contactors	max. nominal continuous current with "n" poles A	Cable cross-sectional area mm ²	Catalog number ①
2-Pole	A145, A185	300	-	LP185
	A210 ... A300	475	-	LP300
	AF400, AF460	725	-	LP460
	AF580, AF750	1200	-	LP750
	A45 ... A75	200	95	LH75
3-Pole	A95, A110	240	-	LY110
	A145, A185	400	-	LY185
	A210 ... A300	670	-	LY300
	AF400, AF460	1000	-	LY460
	AF580, AF750	1650	-	LY750
	A40	140	50	LF40
	A45 ... A75	275	150	LF75

Note: The strips and shorting bars provided for the A... contactors can be used for the AF, AL, AL...Z, AE, TAL and TAE types.

Terminal connecting strips and shorting bars



LY16-4

For contactors	max. nominal continuous current with "n" poles				Cable cross-sectional area	Catalog number
	in parallel		in series			
	2 poles	3 poles	4 poles	2 poles	mm ²	
AF09	30	33	-	25	6	LY16-4
AF12	32	36	-	27	-	
AF16	34	40	-	30	-	
AF26	50	60	-	45	10	LY38-4

① LP460 ... LP750, LY185 ... LY750 not insulated. Use terminal shrouds. Types LH... and LF..., not insulated, includes terminal.

Terminal control leads, blocks & lug kits



LK75-L



LK75-F

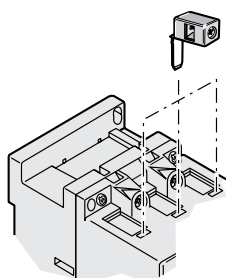

LK... positioning



ATK185



ATK750/3



LD75



LD110

Ordering details

For contactors	Catalog number
Right and left on A45 ... A75	LK75-L
Opposite on A45 ... A75	LK75-F
Right and left on A95 ... A110	LK110

Note: The LK... terminals provided for the A... contactors can be used for the AF, AE, AM, TAE, UA, GA and GAE types.

Terminal lug kits

For contactors	Wire		Tightening torque	Spare terminal hardware included [⊙]	Catalog number
	Range	Capacity	To conductor		
AF145...AF185 A145...A185	4 AWG...300 MCM	1	275 in.-lb	•	ATK185
					ATK185HK
AF210...AF300 A210...A300	4 AWG...400 MCM	1	375 in.-lb	•	ATK300
					ATK300HK
AF400...AF580	4 AWG...500 MCM	2	375 in.-lb	•	ATK300/2
					ATK300/2HK
AF580...AF750	2/0 AWG...500 MCM	2	275 in.-lb	•	ATK580/2
					ATK580/2HK
AF1350	4/0 AWG...500 MCM	4	375 in.-lb	•	ATK750/3
					ATK750/3HK
AF1350...AF1650	1/0 AWG...750 MCM	4	500 in.-lb	•	ATK1350/4
					ATK1350/4HK
AF1350...AF1650	1/0 AWG...750 MCM	6	500 in.-lb	•	ATK1650/4
					ATK1650/4HK

Note: AF1250, AF2050 & AF2650 intended for busbar connection only. Terminal hardware supplied separately. Use of lug kits for AF1350 & AF1650 in general purpose applications reduces the ratings to 1050A and 1350A respectively. Recommend busbar connection for full ratings.

Spare terminal hardware kits

For contactors	Catalog number
A/F145...A/F185	LE185
A/F210...A/F300	LE300
AF400...AF460	LE460
AF580...AF750	LE750

Terminal blocks

For contactors	Catalog number
A45, A75	LD-75
A95, A110	LD-110

Note: The LD... terminal blocks provided for the A... contactors can be used for the AF, AL, AE, TAL, TAE and UA types.

⊙ Terminal hardware include with A(F)145...AF750 contactors; hardware for AF1350 & AF1650 available only with purchase of lug kit.

Terminal shrouds



LT...-AC

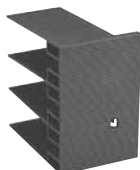

LT...-AL



LT...-AY

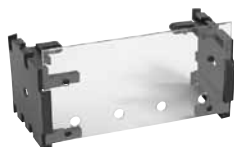

LT210-EK

Ordering details

For contactors	Catalog number
A145 ... A185 with connectors/busbar	LT185-AC
A145 ... A185 with lugs	LT185-AL
A145 ... A185 with short. bar LY185 or between A145 and TA200DU or between A185 and TA200DU	LT185-AY
A210 ... A300 with connectors/busbar	LT300-AC
A210 ... A300 with lugs \emptyset	LT300-AL
A210 ... A300 with short. bar LY300	LT300-AY
AF400 ... AF460 with connectors/busbar	LT460-AC
AF400 ... AF460 with lugs	LT460-AL
AF580 ... AF750 with connectors/busbar	LT750-AC
AF580 ... AF1250 with lugs	LT750-AL

Note: The shrouds provided for the A... contactors can be used for the AF... types.

EK shrouds

For contactors	Catalog number
EK110, EK150	LT150-EK
EK175, EK210	LT210-EK
EK370, EK550	LT550-EK
EK1000	LT1000-EK

\emptyset Cannot be used with lug kit ATK300/2.

Function markers, protective covers & coil terminal blocks

Ordering details



LDC4

For contactors	Catalog number
----------------	----------------

Additional coil terminal block

Additional coil terminal block for a bottom access to the coil terminals of contactors or contactor relays.

AF09 ... AF38, NF	LDC4
-------------------	------



BX4

Protective covers

Sealable and transparent protective covers BX4 and non-removable BX4-CA to protect the devices against accidental contact.

All 1-stack contactors and contactor relays	BX4
For 4-pole CA4 and 2-pole CAT4 auxiliary contact blocks	BX4-CA
For contactors B/C6...B/C7	LT6-B



LT6-B

Function markers

Box of 16 blank cards (16 markers by card) printable on HTP500 thermal transfer printer and AMS 500 marking table to identify your contactors, overload relays or manual motor starters.

Marker dimensions: 7 x 20 mm (.276" x .787").

Box of 16 blank cards - for AF09/Z...AF38/Z, (V)AS/L09...(V)ASL16, NF/Z, NS/L	BA4
AMS 500 support plate for 8 BA4	XUSP02633
HTP500 support plate	1SNA235712R2400
50 pcs. - for A9...A110, AF50...AF110, AL9...AL40, AE9...AE75	BA5-50



BA4



BA5-50

Main dimensions mm, inches

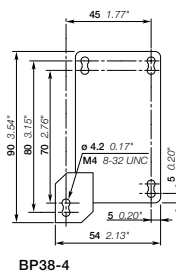
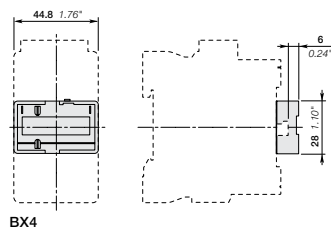

Mounting plates

Description

Mounting plates with fixing holes for the specified contactors and overload relays.



PN300A-11

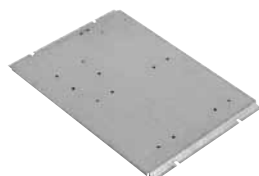

PN300-21

Ordering details

For contactors		For overload relays	Catalog number
----------------	--	---------------------	----------------

Mounting plates for Direct on line starters

A145, A185		TA200DU, E200DU	PN185-11
A210 ... A300		TA450DU, E320DU	PN300A-11
AF400, AF460		E500DU	PN460-11
AF580, AF750		E800DU	PN750-11

For two contactors side by side with space for mechanical interlock		For one or two overload relays	Catalog number
---	--	--------------------------------	----------------

Mounting plates for mechanical interlocked contactors, reversing starters and two speed starters for double windings

A95, A110		TA80DU, TA110DU	PN110-21
A145, A185		TA200DU, E200DU	PN185-21
A210 ... A300		TA450DU, E320DU	PN300-21
AF400, AF460		E500DU	PN460-21
AF580, AF750		E800DU	PN750-21

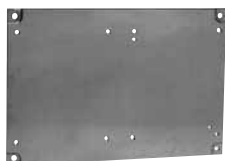

PN...

Mounting plates for two horizontal mounted contactors with or without a mechanical interlock unit.

To use with:			Catalog number
Left hand contactor	Mechanical interlock	Right hand contactor	
EK110, EK150	VH145	EK110, EK150	PN210-22
EK175, EK210	VH300	EK175, EK210	PN300-22

(1) Space for mechanical interlock included.

Adapter plates & accessories

Description

Adapter plates with fixing holes for specified old contactors to new contactors.

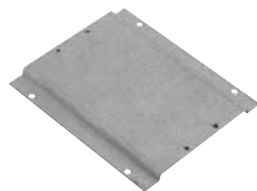

PR300-1



PR400-2

Ordering details

From old contactors	To new contactor	Catalog number
EH65, EH75, EH80, EH90, EG80	A95, A110	PR110-1
EH100, EH145	A110, A145	PR145-1
EH150, EH160, EH175, EH210, EG160	A185, A210	PR210-1
EH250, EH260, EH300	A210 ... A300	PR300-1
EH370, EH550, EG315	AF400 ... AF580	PR460-1
EH700, EH800	AF750	PR750-1
OKYM150, OKYM175	A185	PR185-2
OKYM200, OKYM250	A210 ... A300	PR300-2
OKYM315	AF400, AF460	PR400-2
OKYM400	AF400, AF460	PR460-2
OKYM500	AF580	PR580-2
EH550, EG630, OKYM630	AF580, AF750	PR750-2

Note: The adapter plates provided for the A... contactors can also be used for the AF... contactors.

Dimensions (mm)

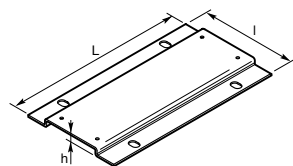

Type of the plate	Dimensions			Fixing holes mm
	L	l	h	
PR110-1	151	106	11.2	2 x \varnothing 7
PR145-1	180	122	11.5	4 x \varnothing 7
PR210-1	200	132	11.5	4 x \varnothing 7
PR300-1	200	172	11.5	4 x \varnothing 7
PR460-1	278	198	11.5	4 x \varnothing 7
PR750-1	283	244	11.5	4 x \varnothing 7
PR185-2	202	152	11.2	4 x \varnothing 11
PR300-2	202	152	11.2	4 x \varnothing 11
PR400-2	278	151	11.5	4 x \varnothing 11
PR460-2	278	176	11.5	4 x \varnothing 11
PR580-2	283	176	11.5	4 x \varnothing 11
PR750-2	283	255	11.5	4 x \varnothing 14

Note: The adapter plates provided for the A... contactors can also be used for the AF... contactors.
Fixing holes according to the plate types



BP38-4

Mounting piece

Mounting piece for replacement of A / AL26 ... A / AL40 contactors mounted by screws by AF contactors in 45 mm width.

AF09 ... AF38	BP38-4
---------------	--------

Replacement parts

Contact kits & arc chutes

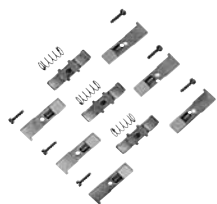

ZL50



ZL185

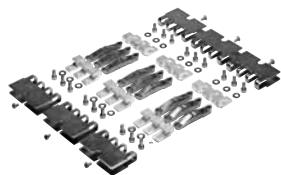

ZL1650



ZW...



KZK370

3-pole contact kits

For contactors	Catalog number
A/AF/AE/TAE50-30	ZL50
A/AF/AE/TAE63-30	ZL63
A/AF/AE/TAE75-30	ZL75
A/AF95-30	ZL95
A/AF110-30	ZL110
A/AF145	ZL145
A/AF185	ZL185
A/AF210	ZL210
A/AF260	ZL260
A/AF300	ZL300
AF400	ZL400
AF460	ZL460
AF580	ZL580
AF750	ZL750
AF1250	ZL1250
AF1350	ZL1350
AF1650	ZL1650
AF2050	ZL2050
UA50	ZLU50
UA63	ZLU63
UA75	ZLU75
UA95	ZLU95
UA110	ZLU110

4-pole contact kits

A/E/F45	ZLT45
A/E/F50	ZLT50
A/E/F75	ZLT75
EK110	KZK110
EK150	KZK150
EK175	KZK175
EK210	KZK210
EK370	KZK370
EK550	KZK550
EK1000	KZK1000

Arc chutes

For contactors	Catalog number
3-pole	
A145 ... A185 and AF145 ... AF185	ZW185
A210 ... A300 and AF210 ... AF300	ZW300
AF400, AF460	ZW460
AF580, AF750, AF1250	ZW750
AF1350, AF1650, AF2050	ZW1650
4-pole	
EK110	KWK110
EK150	KWK150
EK175	KWK175
EK210	KWK210
EK370	KWK370
EK550	KWK550
EK1000	KWK1000

Replacement parts

Coils

Coils, AC operated



ZA16-81

For contactors	Catalog number
A9...A16, A9N00...A16N0, UA16	ZA16-Δ
A26...A40, A26N1, UA26	ZA40-Δ
A45...A75, A50N2...A75N3, UA50...UA75, GA75	ZA75-Δ
A95...A110, UA95...UA110	ZA110-Δ
A145...A185, A145N4	ZA185-Δ
A210...A300, A260N5	ZA300-Δ

Coils, DC operated

AE9...AE16, AE9N00...AE16N0	ZAE16-Δ
AE26...AE40, AE26N1	ZAE40-Δ
AE45...AE75, AE50N2...AE75N3, GAE75	ZAE75-Δ

Coils, AC/DC operated (coil and printed circuit board except ZAF1650)

AF45...AF75, AF50N2...AF75N3	ZAF75-Δ
AF95...AF110	ZAF110-Δ
AF145...AF185, AF145N4, GAF185	ZAF185-Δ
AF210...AF300, AF260N5, GAF300	ZAF300-Δ
AF400...AF460, AF460N6, GAF460	ZAF460-Δ
AF580...AF1250, AF750N5, GAF750...GAF1250	ZAF750-Δ
AF1350...AF2050, AF1650N8, GAF1650...GAF2050	ZAF1650-Δ
Printed circuit board (G/AF1350...2050)	ZP1650



ZAF1650

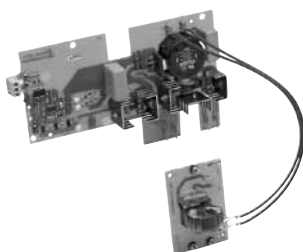

ZP1650

Coils, AC operated for A/UA/GA (Δ)

For contactors	AC voltages		Coil code
	V - 50 Hz	V - 50 Hz	
	24	24	81
	26	28	16
	28	32	17
	42	42	82
	48	48	83
	60	60	73
	100	100...110	74 ⊕
	105	110...127	26
	110	110...120	84
	110...115	115...127	89 ⊕
	120	140	29
A9...A300, A9N00...A260N5, UA16...UA110, GA75	125...127	150	30
	175	208	34
	190	220	36
	220...230	230...240	80
	230...240	240...260	88
	230...240	277	42
	230/400	-	62 ⊕
	-	230/400	63 ⊕
	380...400	400...415	85
	400...415	415...440	86
	400	440	50
	400...415	480	51
	415...440	440...460	87
	440	500	53
	500	600	55
	550	-	56
	660...690	-	58

Coils, DC operated for AE/GAE (Δ)

For contactors	DC voltages V DC	Coil code
	12	80
	24	81
	42	82
	48	83
AE9...AE75, AE9N00...AE75N3, GAE75	50	21
	60	84
	75	85
	110	86
	125	87
	220	88
	240	89
	250	38

Coils, DC operated for AE/GAE (Δ)

AC / DC voltages V - 50/60 Hz or DC	AF50...AF300, AF50N2...AF260N5, GAF185...GAF300	AF400...AF750, AF460N6...AF750N7, GAF460...GAF570	AF1250, GAF1250	AF1350...AF2050, AF1650N8, GAF1650...GAF2050
20...60V DC	72	-	-	-
24...60V DC	-	68	68	-
48...130V AC/DC	69	69	69	-
100...250V AC/DC	70	70	70	70
250...500V AC/DC	-	71	-	-

⊕ For A9...A16, A9N00...A16N0, UA16 only
 ⊕ Excludes A145...A300, A145N4
 ⊕ A145...A300, A145N4 at 60 Hz, 115V only

Replacement parts

Coils

Coils, AC or DC operated



KH300

For contactors	Catalog number
EK110...EK150	KH210-Δ
EK175...EK210	KH300-Δ
EK370...EK1000	KH800-Δ

Note: AC and DC operated contactors DO NOT have the same magnetic structure. Therefore, DC coils will not fit on an AC magnetic structure and vice versa.

Coils, AC operated for EK (Δ)

For contactors	AC voltages		Coil code
	V - 50 Hz	V - 50 Hz	
EK110... EK1000 (AC operated)	-	24	F
	24	-	N
	-	48	G
	110	120	1
	-	208	B
	-	240	2
	220...230	-	J
	-	380	Z
	380...400	440	3
	400...415	-	M
	-	480	4
	500	-	5
	-	600	6

Coils, DC operated for EK (Δ)

For contactors	DC voltages V DC	Coil code
EK110... EK1000 (DC operated)	24	Y
	48	W
	110	P
	125	Q
	220	R
	440	T

Terminal marking and positioning

AF09/Z...AF38/Z, AF09N00/Z...AF26N1/Z

3-pole contactors

Standard devices without addition of auxiliary contacts

Note: Terminal markings for AF09 & AF16 apply to AF NEMA Sz. 00 & 0; terminal markings for AF26 apply to AF NEMA Sz. 1. AF09...AF38 terminal markings apply to AF.Z type.

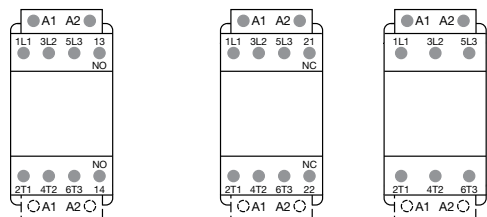

AF09...AF16...-30-10

AF09...AF16...-30-01

AF26...AF38...-30-00

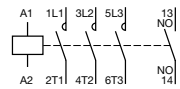

AF09...AF16...-30-10

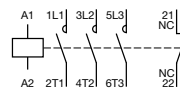

AF09...AF16...-30-01

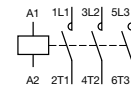

AF26...AF38...-30-00

Other possible contact combinations with auxiliary contacts

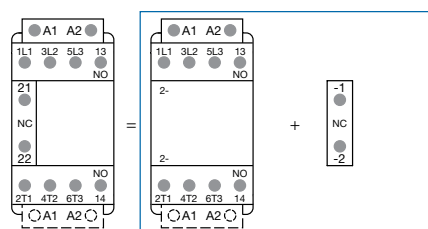

Combination 11 = AF09...AF16...-30-10 + CA4-01

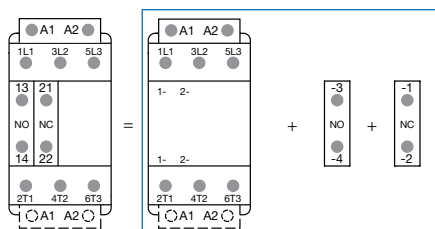

Combination 11 = AF26...AF38...-30-00 + CA4-10 + CA4-01

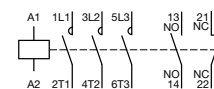

Combination 11

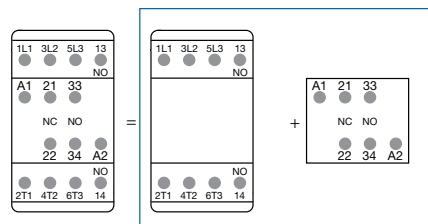

Combination 21 = AF09...AF16...-30-10 + CAT4-11M

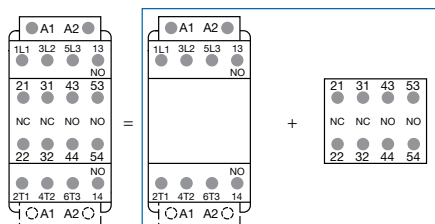

Combination 32 = AF09...AF16...-30-10 + CA4-22M

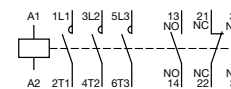

Combination 21

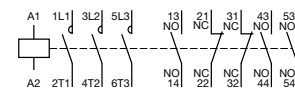

Combination 32

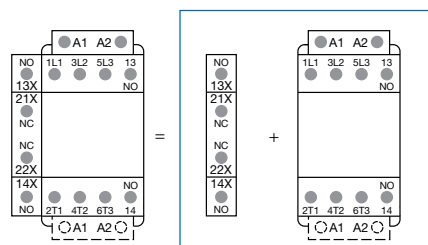

Combination 21 = CAL4-11 + AF09...AF16...-30-10

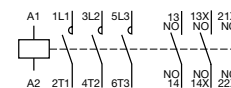

Combination 21

Note: Only AF.Z contactor with DC control voltage 12...20 V DC need to respect the connection polarities indicated close to the coil terminals: A1+ for the positive pole and A2- for the negative pole

Terminal marking and positioning AF09/Z...AF38/Z 4-pole contactors

Note: AF09...AF38 terminal markings apply to AF.Z type.

Standard devices without addition of auxiliary contacts

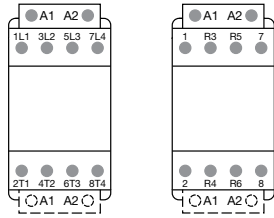

AF09 ... AF38.-40-00 AF09 ... AF38.-22-00

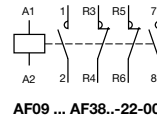
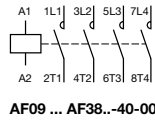

Other possible contact combinations with auxiliary contacts

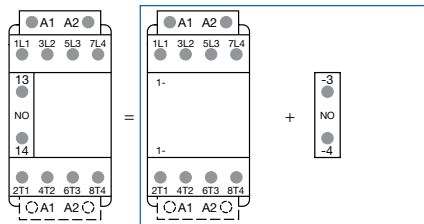

Combination 10 = AF09 ... AF38.-40-00 + CA4-10

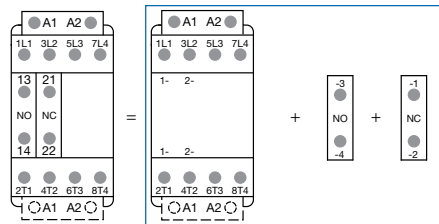

Combination 11 = AF09 ... AF38.-40-00 + CA4-10 + CA4-01

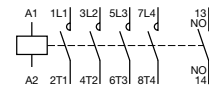

Combination 10

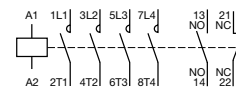

Combination 11

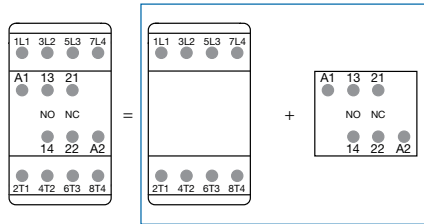

Combination 11 = AF09 ... AF38.-40-00 + CAT4-11E

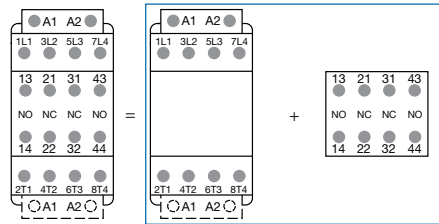

Combination 22 = AF09 ... AF38.-40-00 + CA4-22E

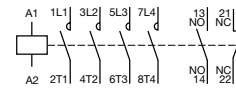

Combination 11

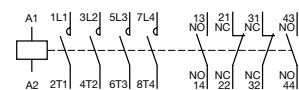

Combination 22

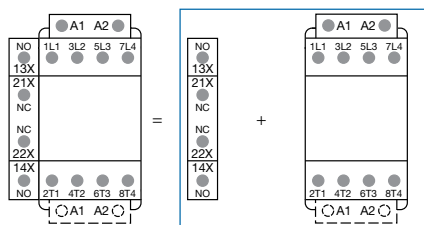

Combination 11 = CAL4-11 + AF09 ... AF38-40-00

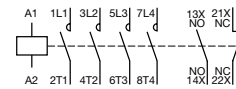

Combination 11

Note: Only AF.Z contactor with DC control voltage 12...20 V DC need to respect the connection polarities indicated close to the coil terminals: A1+ for the positive pole and A2- for the negative pole

Terminal markings and positioning

Add-on auxiliary contacts for AF09/Z...AF38/Z

1-pole auxiliary contacts

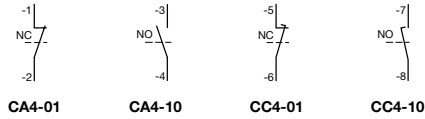

2-pole auxiliary contacts

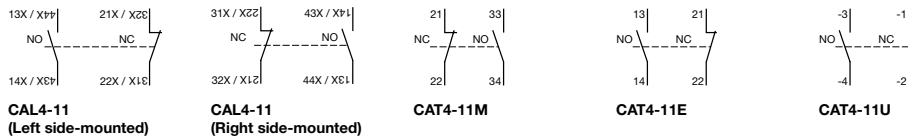

4-pole auxiliary contacts

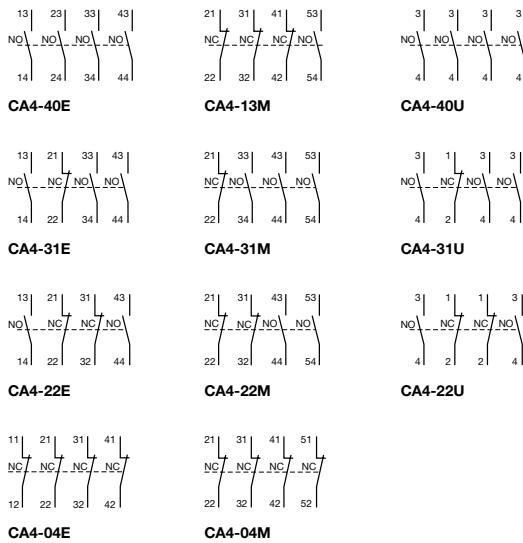

Terminal markings and positioning AS/L09../S...AS/L16../S & CA3 auxiliary contacts

ASL../S contactors - DC operated (the polarity A1+, A2- must be respected)

Standard devices without addition of auxiliary contacts

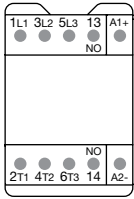

AS/L09...AS/L16-30-10/S

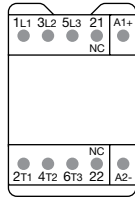

AS/L09...AS/L16-30-01/S

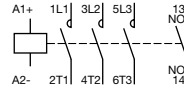

AS/L09...AS/L16-30-10/S

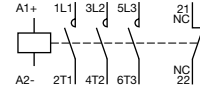

AS/L09...AS/L16-30-01/S

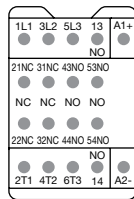

AS/L09...AS/L16-30-32/S

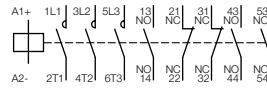

AS/L09...AS/L16-30-32/S

Other possible contact combinations with auxiliary contact blocks added by the user

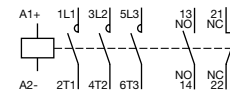
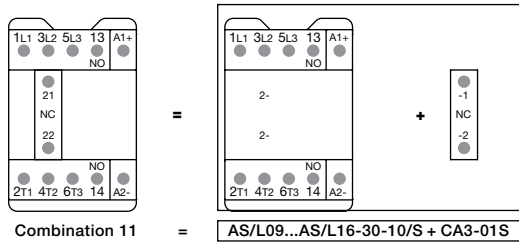

Combination 11

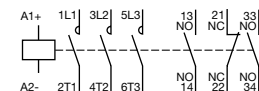
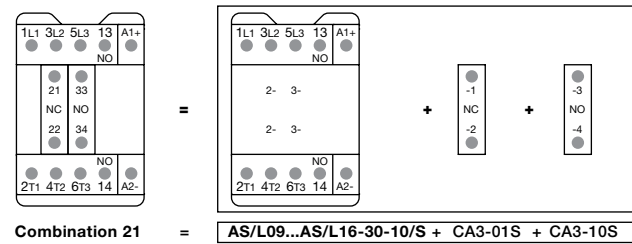

Combination 21

CA3..S 1-pole auxiliary contact blocks

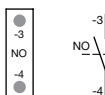

CA3-10/S

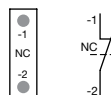

CA3-01/S

Terminal markings and positioning

Add-on auxiliary contacts CA5 / CAL5 / CC5 / CAL16

One pole auxiliary contacts (top mounted)

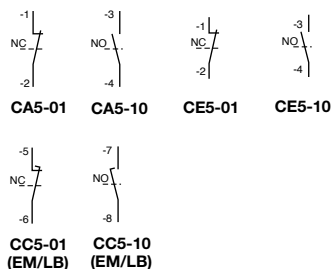

Legend
L.H.S. = Left hand side mounted
R.H.S. = Right hand side mounted
EM/LB = Early make / Late break

Two pole auxiliary contacts

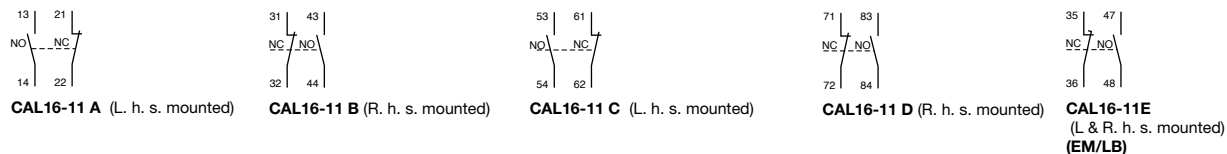
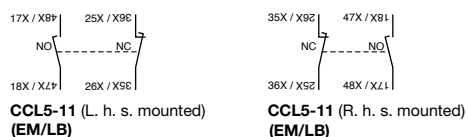

Four pole auxiliary contacts (Top mounted)

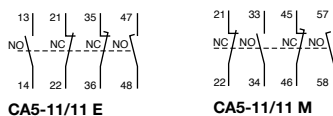
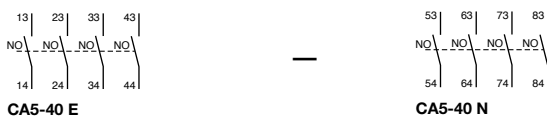
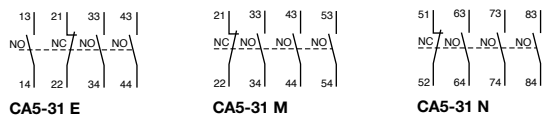
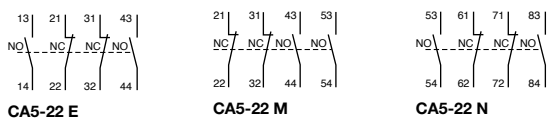
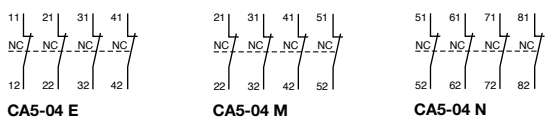

Terminal markings and positioning A9...A75

Standard devices without addition of auxiliary contacts

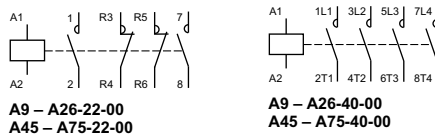
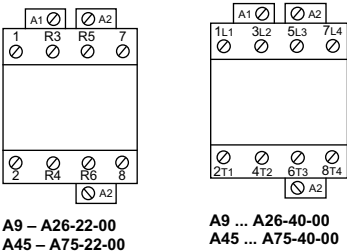
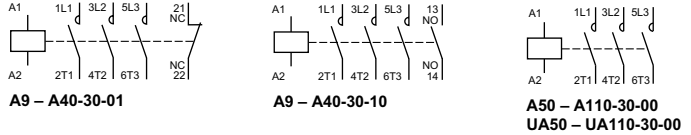
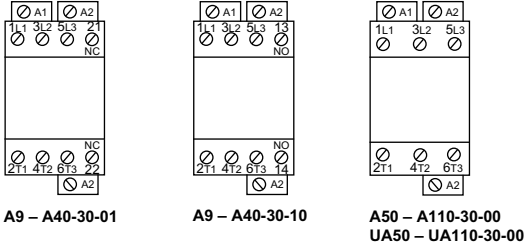

Standard 3 pole devices with factory mounted auxiliary contacts

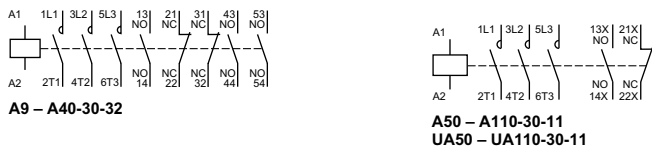
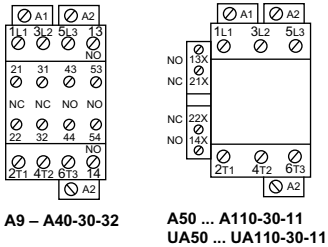
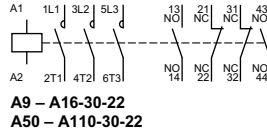
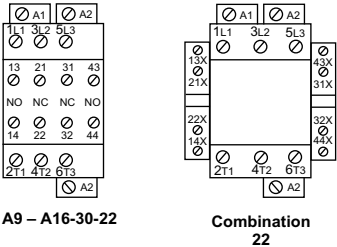

Other possible contact combinations with auxiliary contacts added by the user

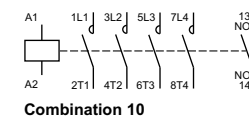
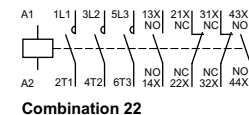
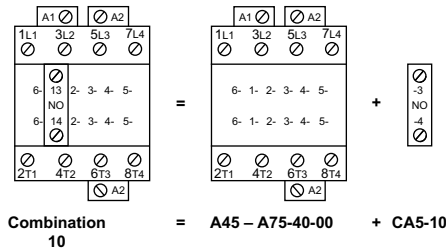
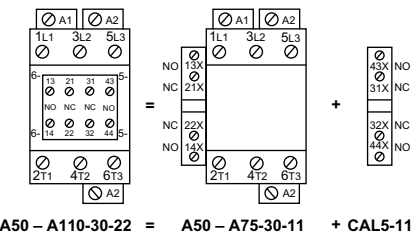
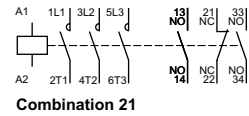
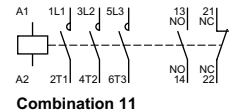
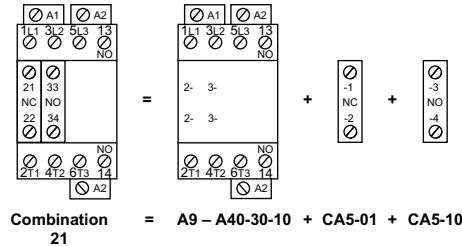
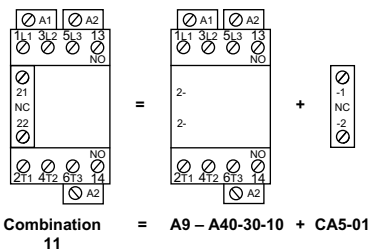

Terminal markings and positioning AE9...AE75, AL9...AL40

AE Contactors – D.C. operated

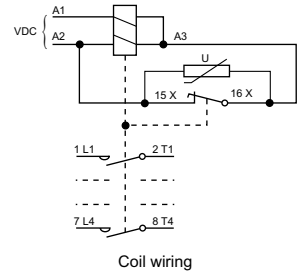
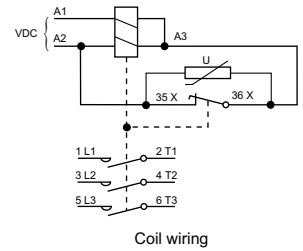
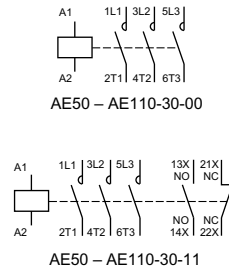
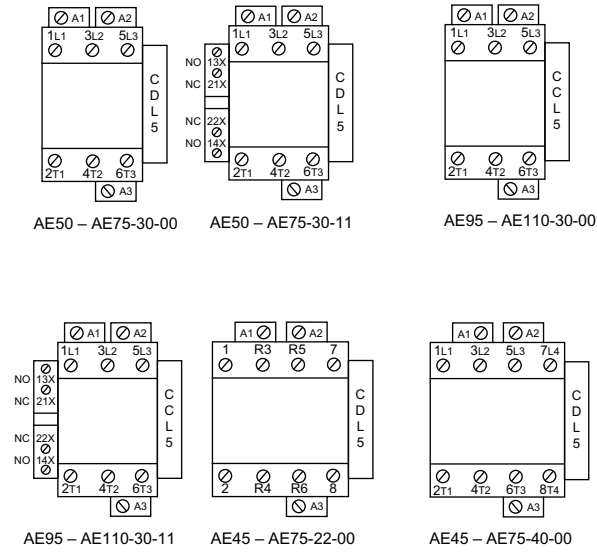

AL Contactors – D.C. operated

Standard devices without addition of auxiliary contacts

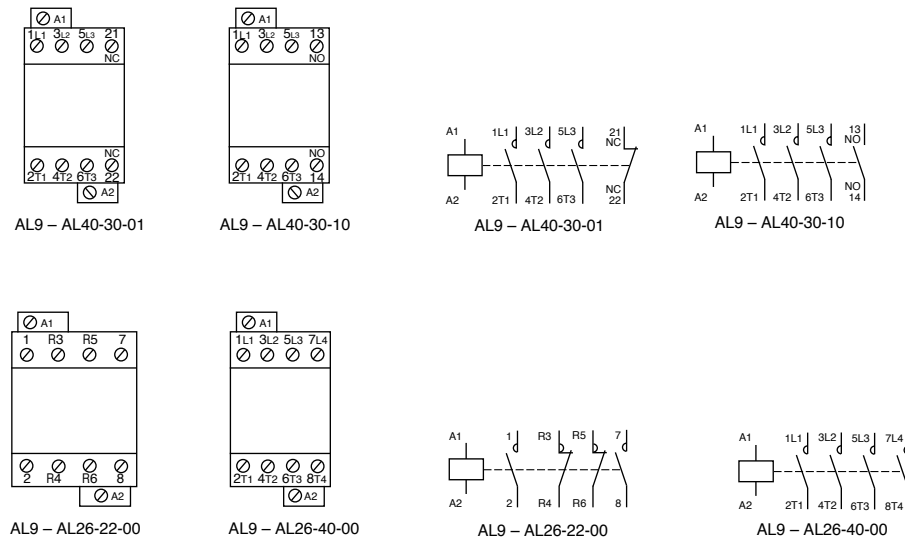

Other possible contact combinations with auxiliary contacts added by the user

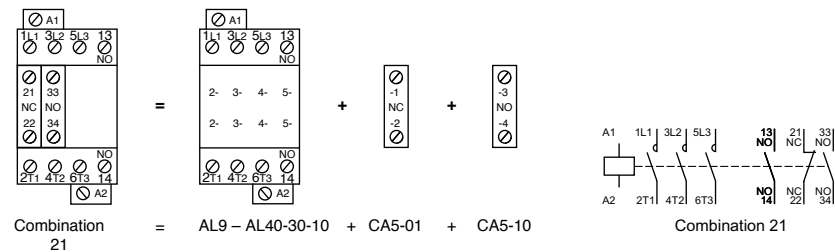

Terminal markings and positioning B/C6...B/C7, CA6 & CAF6 auxiliary contacts

Miniature contactors

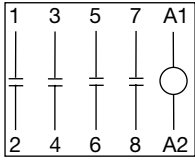

B6(7)-40-00 ...
BC6(7)-40-00 ...

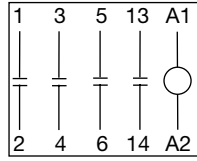

B6(7)-30-10 ...
BC6(7)-30-10 ...

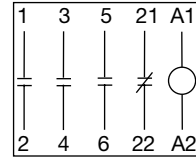

B6(7)-30-01 ...
BC6(7)-30-01 ...

Miniature mechanically interlocked contactors

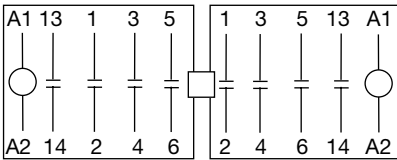

VB6(7)-30-10 ...
VBC6(7)-30-10 ...

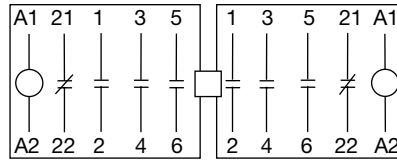

VB6(7)-30-01 ...
VBC6(7)-30-01 ...

Miniature control relays

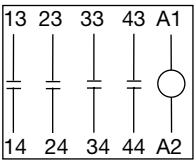

K6-40 E ...
KC6-40 E ...

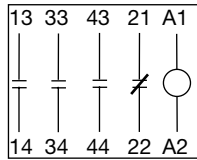

K6-31 Z ...
KC6-31 Z ...

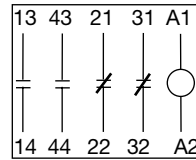

K6-22 Z ...
KC6-22 Z ...

Side mounted auxiliary contact blocks

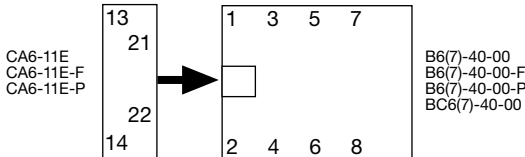

B6(7)-40-00
B6(7)-40-00-F
B6(7)-40-00-P
BC6(7)-40-00

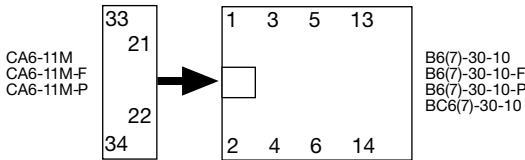

B6(7)-30-10
B6(7)-30-10-F
B6(7)-30-10-P
BC6(7)-30-10

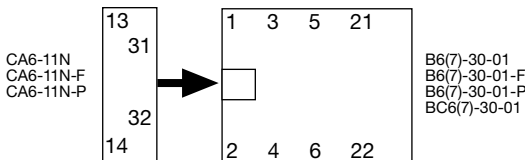

B6(7)-30-01
B6(7)-30-01-F
B6(7)-30-01-P
BC6(7)-30-01

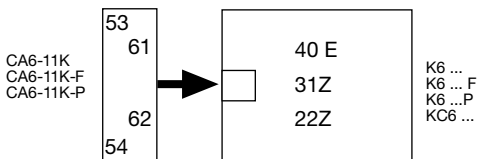

K6 ...
K6 ... F
K6 ... P
KC6 ...

Front mounted auxiliary contact blocks

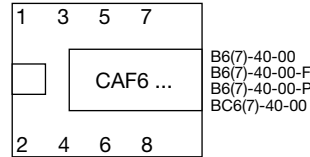

B6(7)-40-00
B6(7)-40-00-F
B6(7)-40-00-P
BC6(7)-40-00

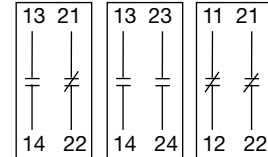

1 = CAF6-11E
2 = CAF6-20E
3 = CAF6-02E

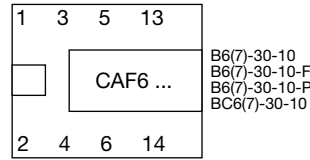

B6(7)-30-10
B6(7)-30-10-F
B6(7)-30-10-P
BC6(7)-30-10

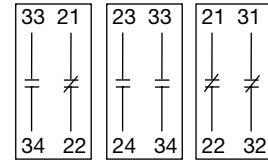

1 = CAF6-11M
2 = CAF6-20M
3 = CAF6-02M

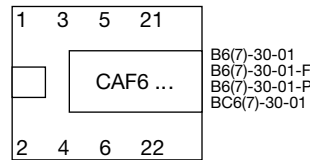

B6(7)-30-01
B6(7)-30-01-F
B6(7)-30-01-P
BC6(7)-30-01

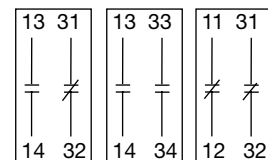

1 = CAF6-11N
2 = CAF6-20N
3 = CAF6-02N

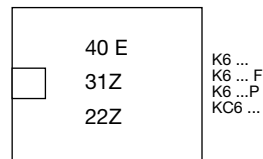

K6 ...
K6 ... F
K6 ... P
KC6 ...

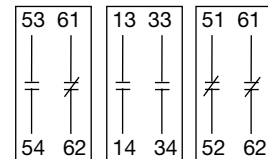

1 = CAF6-11K
2 = CAF6-20K
3 = CAF6-02K

NOTE: Only side mounted type or front mounted type auxiliary contact blocks can be used at one time. Auxiliary contact blocks must not be mounted on Interface contactors, Interface control relays or contactors for connection to PLCs. Two CAF 6 front mounted auxiliary contact blocks can be installed on the mechanically interlocked contactors VB(C)6(7).

IEC Technical data

AF09(Z)...AF38(Z), 3-pole

Utilization characteristics

Across the line
Contactors

1

Main pole - Utilization characteristics according to IEC

Contactor types	AC / DC operated	AF09	AF12	AF16	AF26	AF30	AF38	
Standards		IEC 60947-1 / 60947-4-1 and EN 60947-1 / 60947-4-1						
Rated operational voltage U _e max.		690 V						
Rated frequency (without derating)		50 / 60 Hz						
Conventional free-air thermal current I _{th}								
acc. to IEC 60947-4-1, open contactors, $\theta \leq 40^\circ\text{C}$		35 A	35 A	35 A	50 A	50 A	50 A	
With conductor cross-sectional area		6 mm ²	6 mm ²	6 mm ²	10 mm ²	10 mm ²	10 mm ²	
AC-1 Utilization category								
For air temperature close to contactor								
I_e / Rated operational current AC-1								
$\theta \leq 40^\circ\text{C}$		25 A	28 A	30 A	45 A	50 A	50 A	
U _e max. $\leq 690\text{ V}$, 50/60 Hz		$\theta \leq 60^\circ\text{C}$	25 A	28 A	30 A	40 A	42 A	42 A
		$\theta \leq 70^\circ\text{C}$	22 A	24 A	26 A	32 A	37 A	37 A
With conductor cross-sectional area		4 mm ²	6 mm ²	6 mm ²	10 mm ²	10 mm ²	10 mm ²	
AC-3 Utilization category								
For air temperature close to contactor $\theta \leq 60^\circ\text{C}$								
I_e / Max. rated operational current AC-3 (1)								
		220-230-240 V	9 A	12 A	18 A	26 A	33 A	40 A
		380-400 V	9 A	12 A	18 A	26 A	32 A	38 A
		415 V	9 A	12 A	18 A	26 A	32 A	38 A
		440 V	9 A	12 A	18 A	26 A	32 A	38 A
		500 V	9.5 A	12.5 A	15 A	23 A	28 A	33 A
		690 V	7 A	9 A	10.5 A	17 A	21 A	24 A
		220-230-240 V	2.2 kW	3 kW	4 kW	6.5 kW	9 kW	11 kW
		380-400 V	4 kW	5.5 kW	7.5 kW	11 kW	15 kW	18.5 kW
		415 V	4 kW	5.5 kW	9 kW	11 kW	15 kW	18.5 kW
		440 V	4 kW	5.5 kW	9 kW	15 kW	18.5 kW	22 kW
		500 V	5.5 kW	7.5 kW	9 kW	15 kW	18.5 kW	22 kW
		690 V	5.5 kW	7.5 kW	9 kW	15 kW	18.5 kW	22 kW
Rated making capacity AC-3		10 x I _e AC-3 acc. to IEC 60947-4-1						
Rated breaking capacity AC-3		8 x I _e AC-3 acc. to IEC 60947-4-1						
AC-8a Utilization category								
(without thermal overload relay - U _e 400 V 50/60 Hz - $\theta \leq 40^\circ\text{C}$)								
I_e / Rated operational current AC-8a		12 A	16 A	22 A	30 A	40 A	50 A	
Rated operational power AC-8a		5.5 kW	7.5 kW	11 kW	15 kW	20 kW	25 kW	
Short-circuit protection device for contactors								
without thermal overload relay - Motor protection excluded (2)								
U _e $\leq 500\text{ V AC}$ - gG type fuse		25 A	32 A	32 A	50 A	63 A	63 A	
Rated short-time withstand current I_{cw}								
at 40 °C ambient temperature,		1 s	300 A	300 A	300 A	700 A	700 A	700 A
in free air from a cold state		10 s	150 A	150 A	150 A	350 A	350 A	350 A
		30 s	80 A	80 A	80 A	225 A	225 A	225 A
		1 min	60 A	60 A	60 A	150 A	150 A	150 A
		15 min	35 A	35 A	35 A	50 A	50 A	50 A
Maximum breaking capacity								
cos $\phi = 0.45$		at 440 V	250 A	250 A	250 A	500 A	500 A	500 A
		at 690 V	106 A	106 A	106 A	200 A	200 A	200 A
Power dissipation per pole								
		I _e / AC-1	0.8 W	1 W	1.2 W	1.8 W	2.4 W	2.4 W
		I _e / AC-3	0.1 W	0.2 W	0.35 W	0.6 W	0.9 W	1.3 W
Max. electrical switching frequency								
		AC-1	600 cycles/h					
		AC-3	1200 cycles/h					
		AC-2, AC-4	300 cycles/h			150 cycles/h		

Note: total power loss = power dissipation per pole x number of poles + coil consumption.

(1) For the corresponding kW/A or hp/A values of 1500 r.p.m, 50 Hz or 1800 r.p.m, 60 Hz, 3-phase motors, see "Motor rated operational powers and currents".
 (2) For the protection of motor starters against short circuits, see "Coordination with short-circuit protection devices".

IEC Technical data

A/E/L40, A/E/F50...AF110, 3-pole

Utilization characteristics

Main pole - Utilization characteristics according to IEC

Contactor types	AC operated	A40	A50	A63	A75	A95	A110
	DC operated	AL40	AE50	AE63	AE75	–	–
		TAL40	TAE50	–	TAE75	–	–
	AC / DC operated	–	AF50	AF63	AF75	AF95	AF110
Standards	IEC 60947-1 / 60947-4-1 and EN 60947-1 / 60947-4-1						
Rated operational voltage U_e max.	690 V		1000 V (690 V for AF.. contactors)			1000 V	
Rated frequency (without derating)	50/60 Hz						
Conventional free-air thermal current I_{th} acc. to IEC 60947-4-1, open contactors, $\theta \leq 40^\circ\text{C}$		65 A	100 A	125 A	125 A	145 A	160 A
With conductor cross-sectional area		16 mm ²	35 mm ²	50 mm ²	50 mm ²	50 mm ²	70 mm ²
AC-1 Utilization category For air temperature close to contactor							
I_e / Rated operational current AC-1	$\theta \leq 40^\circ\text{C}$	60 A	100 A	115 A	125 A	145 A	160 A
U _e max. $\leq 690\text{ V}, 50/60\text{ Hz}$	$\theta \leq 55^\circ\text{C}$	60 A	85 A	95 A	105 A	135 A	145 A
	$\theta \leq 70^\circ\text{C}$ (3)	42 A	70 A	80 A	85 A	115 A	130 A
With conductor cross-sectional area		16 mm ²	35 mm ²	50 mm ²	50 mm ²	50 mm ²	70 mm ²
AC-3 Utilization category For air temperature close to contactor $\theta \leq 55^\circ\text{C}$							
I_e / Max. rated operational current AC-3 (1)							
	220-230-240 V	40 A	53 A	65 A	75 A	96 A	110 A
	380-400 V	37 A	50 A	65 A	75 A	96 A	110 A
	415 V	37 A	50 A	65 A	75 A	96 A	110 A
	440 V	37 A	45 A	65 A	70 A	93 A	100 A
	500 V	33 A	45 A	55 A	65 A	80 A	100 A
	690 V	25 A (4)	35 A	43 A	46 A	65 A	82 A
	1000 V	–	23 A (6)	25 A (6)	28 A (6)	30 A	30 A
Rated operational power AC-3 (1)							
	220-230-240 V	11 kW	15 kW	18.5 kW	22 kW	25 kW	30 kW
	380-400 V	18.5 kW	22 kW	30 kW	37 kW	45 kW	55 kW
	415 V	18.5 kW	25 kW	37 kW	40 kW	55 kW	59 kW
	440 V	22 kW	25 kW	37 kW	40 kW	55 kW	59 kW
	500 V	22 kW	30 kW	37 kW	45 kW	55 kW	59 kW
	690 V	22 kW (4)	30 kW	37 kW	40 kW	55 kW	75 kW
	1000 V	–	30 kW (6)	33 kW (6)	37 kW (6)	40 kW	40 kW
Rated making capacity AC-3	10 x I _e AC-3 acc. to IEC 60947-4-1						
Rated breaking capacity AC-3	8 x I _e AC-3 acc. to IEC 60947-4-1						
AC-8a Utilization category (without thermal overload relay - U _e 400 V 50/60 Hz - $\theta \leq 40^\circ\text{C}$)							
I_e / Rated operational current AC-8a		50 A	63 A	85 A	95 A	120 A	140 A
Rated operational power AC-8a		22 kW	30 kW	45 kW	45 kW	55 kW	75 kW
Short-circuit protection device for contactors without thermal overload relay - Motor protection excluded (2)							
U _e $\leq 500\text{ V AC}$ - gG type fuse		63 A	100 A	125 A	160 A	160 A	200 A
Rated short-time withstand current I_{cw} at 40 °C ambient temperature, in free air from a cold state	1 s	600 A	1000 A			1320 A	
	10 s	400 A	650 A			800 A	
	30 s	225 A	370 A			500 A	
	1 min	150 A	250 A			350 A	
	15 min	65 A	110 A	135 A	135 A	160 A	175 A
Maximum breaking capacity cos $\phi = 0.45$	at 440 V	820 A (5)	1300 A			1160 A	
(cos $\phi = 0.35$ for I _e > 100 A)	at 690 V	340 A (5)	630 A			800 A	
Power dissipation per pole	I_e / AC-1	3 W	5 W	6.5 W	7 W	6.5 W	7.5 W
	I_e / AC-3	1.3 W	1.3 W	1.5 W	2 W	2.7 W	3.6 W
Max. electrical switching frequency	AC-1	600 cycles/h	600 cycles/h (300 for AF., AE., TAE.)			300 cycles/h	
	AC-3	1200 cycles/h	600 cycles/h (300 for AF., AE., TAE.)			300 cycles/h	
	AC-2, AC-4	300 cycles/h	150 cycles/h				

(1) For the corresponding kW/A or hp/A values of 1500 r.p.m. 50 Hz or 1800 r.p.m. 60 Hz, 3-phase motors, see "Motor rated operational powers and currents".

(2) For the protection of motor starters against short circuits, see "Coordination with short-circuit protection devices".

(3) Unauthorized for TAL., TAE.. contactors.

(4) AC-3, 690 V values for AL40 and TAL40 contactors: 18.5 kW, I_e = 21 A.

(5) Max. breaking capacity for AL40 and TAL40 contactors: 470 A at 440 V, 175 A at 690 V.

(6) AF contactors excluded.

IEC Technical data

A/F145...AF300, 3-pole

Utilization characteristics

Across the line
Contactors

1

Main pole - Utilization characteristics according to IEC

Contactor types	AC operated	A145	A185	A210	A260	A300
	AC / DC operated	AF145	AF185	AF210	AF260	AF300
Standards		IEC 60947-1 / 60947-4-1 and EN 60947-1 / 60947-4-1				
Rated operational voltage Ue max.		1000 V		690 V		
Rated frequency (without derating)		50/60 Hz				
Conventional free-air thermal current Ith						
acc. to IEC 60947-4-1, open contactors, $\theta \leq 40^\circ\text{C}$		250 A	275 A	350 A	400 A	500 A (4)
With conductor cross-sectional area (3)		120 mm ²	150 mm ²	185 mm ²	240 mm ²	300 mm ² (4)
AC-1 Utilization category						
For air temperature close to contactor						
Ie / Rated operational current AC-1	$\theta \leq 40^\circ\text{C}$	250 A	275 A	350 A	400 A	500 A (4)
Ue max. $\leq 690\text{ V}$, 50/60 Hz	$\theta \leq 55^\circ\text{C}$	230 A	250 A	300 A	350 A	400 A (4)
	$\theta \leq 70^\circ\text{C}$	180 A	180 A	240 A	290 A	325 A (4)
Ie / Rated operational current AC-1	$\theta \leq 40^\circ\text{C}$	180 A	200 A	–	–	–
Ue max. $\leq 1000\text{ V}$, 50/60 Hz	$\theta \leq 55^\circ\text{C}$	180 A	200 A	–	–	–
	$\theta \leq 70^\circ\text{C}$	180 A	180 A	–	–	–
With conductor cross-sectional area		120 mm ²	150 mm ²	185 mm ²	240 mm ²	300 mm ² (4)
AC-3 Utilization category						
For air temperature close to contactor $\theta \leq 55^\circ\text{C}$						
Ie / Max. rated operational current AC-3 (1)						
	220-230-240 V	145 A	185 A	210 A	260 A	305 A
	380-400 V	145 A	185 A	210 A	260 A	305 A
	415 V	145 A	185 A	210 A	260 A	300 A
	440 V	145 A	185 A	210 A	240 A	280 A
	500 V	145 A	170 A	210 A	240 A	280 A
	690 V	120 A	170 A	210 A	220 A	280 A
	1000 V	80 A	95 A	–	–	–
Rated operational power AC-3 (1)						
	220-230-240 V	45 kW	55 kW	59 kW	80 kW	90 kW
	380-400 V	75 kW	90 kW	110 kW	140 kW	160 kW
	415 V	75 kW	90 kW	110 kW	140 kW	160 kW
	440 V	75 kW	90 kW	110 kW	140 kW	160 kW
	500 V	90 kW	110 kW	132 kW	180 kW	200 kW
	690 V	110 kW	132 kW	160 kW	200 kW	250 kW
	1000 V	110 kW	132 kW	–	–	–
Rated making capacity AC-3		10 x Ie AC-3 acc. to IEC 60947-4-1				
Rated breaking capacity AC-3		8 x Ie AC-3 acc. to IEC 60947-4-1				
Short-circuit protection device for contactors						
without thermal overload relay - Motor protection excluded (2)						
Ue $\leq 500\text{ V}$ AC - gG type fuse		315 A	355 A	400 A	500 A	500 A
Rated short-time withstand current Icw						
at 40 °C ambient temperature,	1 s	1800 A	2000 A	2500 A	3500 A	3500 A
in free air from a cold state	10 s	1200 A	1500 A	1700 A	2400 A	2400 A
	30 s	800 A	1000 A	1200 A	1500 A	1500 A
	1 min	600 A	800 A	1000 A	1100 A	1100 A
	15 min	280 A	320 A	400 A	500 A	500 A
Maximum breaking capacity						
cos $\phi = 0.45$	at 440 V	1500 A	2000 A	2300 A	2600 A	3000 A
(cos $\phi = 0.35$ for Ie > 100 A)	at 690 V	1200 A	1600 A	2000 A	2400 A	2500 A
Power dissipation per pole	Ie / AC-1	13 W	16 W	18 W	25 W	32 W
	Ie / AC-3	5 W	8 W	9 W	14 W	18 W
Max. electrical switching frequency						
	AC-1	300 cycles/h		300 cycles/h		
	AC-3	300 cycles/h		300 cycles/h		
	AC-2, AC-4	150 cycles/h		150 cycles/h		



3-phase motors



1500 r.p.m. 50 Hz
1800 r.p.m. 60 Hz
3-phase motors

(1) For the corresponding kW/A or hp/A values of 1500 r.p.m. 50 Hz or 1800 r.p.m. 60 Hz, 3-phase motors, see "Motor rated operational powers and currents".

(2) For the protection of motor starters against short circuits, see "Coordination with short-circuit protection devices".

(3) Conductors with preparation.

(4) Use terminal extension / enlargement pieces (LX 300 / LW 300).

IEC Technical data

AF400...AF2050, 3-pole

Utilization characteristics

Main pole - Utilization characteristics according to IEC

Contactor types	AC / DC operated	AF400	AF460	AF580	AF750	AF1250	AF1350	AF1650	AF2050
Standards		IEC 60947-1 / 60947-4-1 and EN 60947-1 / 60947-4-1							
Rated operational voltage U _e max.		1000 V							
Rated frequency (without derating)		50/60 Hz							
Conventional free-air thermal current I _{th}									
acc. to IEC 60947-4-1, open contactors, $\theta \leq 40^\circ\text{C}$		600 A	700 A	800 A	1050 A	1260 A	1350 A	1650 A	2050 A
With conductor cross-sectional area (3)		2x185 mm ²	2x240 mm ²	2x240 mm ²	800 mm ² (4)	1000 mm ² (4)	1000 mm ² (5)	1500 mm ² (5)	2000 mm ² (5)
AC-1 Utilization category									
For air temperature close to contactor									
I_e / Rated operational current AC-1	$\theta \leq 40^\circ\text{C}$	600 A	700 A	800 A	1050 A	1260 A	1350 A	1650 A	2050 A
U _e max. $\leq 690\text{ V}$, 50/60 Hz	$\theta \leq 55^\circ\text{C}$	500 A	600 A	700 A	875 A	1040 A	1150 A	1450 A	1750 A
	$\theta \leq 70^\circ\text{C}$	400 A	480 A	580 A	720 A	875 A	1000 A	1270 A	1500 A
I_e / Rated operational current AC-1	$\theta \leq 40^\circ\text{C}$	600 A	700 A	800 A	1000 A	1260 A	1350 A	1650 A	2050 A
U _e max. $\leq 1000\text{ V}$, 50/60 Hz	$\theta \leq 55^\circ\text{C}$	500 A	600 A	700 A	875 A	1040 A	1150 A	1450 A	1750 A
	$\theta \leq 70^\circ\text{C}$	400 A	480 A	580 A	720 A	875 A	1000 A	1270 A	1500 A
With conductor cross-sectional area		2x185 mm ²	2x240 mm ²	2x240 mm ²	800 mm ² (4)	1000 mm ² (4)	1000 mm ² (5)	1500 mm ² (5)	2000 mm ² (5)
AC-3 Utilization category									
For air temperature close to contactor $\theta \leq 55^\circ\text{C}$									
I_e / Max. rated operational current AC-3 (1)									
	220-230-240 V	400 A	460 A	580 A	750 A	–	860 A	1050 A	–
	380-400 V	400 A	460 A	580 A	750 A	–	860 A	1050 A	–
	415 V	400 A	460 A	580 A	750 A	–	860 A	1050 A	–
	440 V	400 A	460 A	580 A	750 A	–	860 A	1050 A	–
	500 V	400 A	460 A	580 A	750 A	–	800 A	950 A	–
	690 V	350 A	400 A	500 A	650 A	–	800 A	950 A	–
	1000 V	155 A	200 A	250 A	300 A	–	–	–	–
Rated operational power AC-3 (1)									
	220-230-240 V	110 kW	132 kW	160 kW	220 kW	–	257 kW	315 kW	–
	380-400 V	200 kW	250 kW	315 kW	400 kW	–	475 kW	560 kW	–
	415 V	220 kW	250 kW	355 kW	425 kW	–	500 kW	600 kW	–
	440 V	220 kW	250 kW	355 kW	450 kW	–	560 kW	670 kW	–
	500 V	250 kW	315 kW	400 kW	520 kW	–	560 kW	700 kW	–
	690 V	315 kW	355 kW	500 kW	600 kW	–	750 kW	900 kW	–
	1000 V	220 kW	280 kW	355 kW	400 kW	–	–	–	–
Rated making capacity AC-3		10 x I _e AC-3 acc. to IEC 60947-4-1							
Rated breaking capacity AC-3		8 x I _e AC-3 acc. to IEC 60947-4-1							
Short-circuit protection device for contactors									
without thermal overload relay - Motor protection excluded (2)									
U _e $\leq 500\text{ V AC}$ - gG type fuse		630 A	800 A	1000 A	1000 A	Please consult us for coordination with circuit-breaker			
Rated short-time withstand current I_{cw}									
at 40 °C ambient temperature, in free air from a cold state	1 s	4600 A	4600 A	7000 A	7000 A	8000 A	10000 A	12000 A	12000 A
	10 s	4400 A	4400 A	6400 A	6400 A	7200 A	8000 A	10000 A	10000 A
	30 s	3100 A	3100 A	4500 A	4500 A	5200 A	6000 A	7500 A	7500 A
	1 min	2500 A	2500 A	3500 A	3500 A	4000 A	4500 A	5500 A	5500 A
	15 min	840 A	840 A	1300 A	1300 A	1500 A	1600 A	2200 A	2200 A
Maximum breaking capacity									
cos $\phi = 0.45$	at 440 V	4000 A	5000 A	6000 A	7500 A	–	10000 A	12000 A	8400 A
(cos $\phi = 0.35$ for I _e > 100 A)	at 690 V	3500 A	4500 A	5000 A	7000 A	–	–	–	–
Power dissipation per pole	I _e / AC-1	30 W	42 W	32 W	50 W	80 W	80 W	80 W	125 W
	I _e / AC-3	16 W	21 W	17 W	28 W	–	50 W	50 W	–
Max. electrical switching frequency									
	AC-1	300 cycles/h		300 cycles/h		300 cycles/h	60 cycles/h		60 cycles/h
	AC-3	300 cycles/h		300 cycles/h		–	60 cycles/h		–
	AC-2, AC-4	60 cycles/h		60 cycles/h		–	60 cycles/h		–



(1) For the corresponding kW/A or hp/A values of 1500 r.p.m, 50 Hz or 1800 r.p.m, 60 Hz, 3-phase motors, see "Motor rated operational powers and currents".

(2) For the protection of motor starters against short circuits, see "Coordination with short-circuit protection devices".

(3) Conductors with preparation.

(4) Max. connection bar width 50 mm.

(5) Max. connection bar width 100 mm.

UL/NEMA/CSA Technical data

AF09(Z)...AF38(Z); AF09N00(Z)...AF26N1(Z), 3-pole

Utilization characteristics

Main pole - Utilization characteristics according to UL / NEMA / CSA

Contactor types	AC / DC operated	AF09	AF12	AF16	AF26	AF30	AF38
Standards		UL 508, CSA C22.2 N°14					
Max. operational voltage		600 V					
NEMA size		00	0	-	1	-	-
NEMA continuous amp rating	Thermal current	9 A	18 A		27 A		
NEMA maximum horse power ratings 1-phase, 60 Hz	115 V AC	1/3 hp	1 hp		2 hp		
	230 V AC	1 hp	2 hp		3 hp		
NEMA maximum horse power ratings 3-phase, 60 Hz	200 V AC	1-1/2 hp	3 hp		7-1/2 hp		
	230 V AC	1-1/2 hp	3 hp		7-1/2 hp		
	460 V AC	2 hp	5 hp		10 hp		
	575 V AC	2 hp	5 hp		10 hp		
	UL / CSA general use rating						
600 V AC		25 A	28 A	30 A	45 A	50 A	50 A
With conductor cross-sectional area		AWG 10	AWG 10	AWG 10	AWG 8	AWG 8	AWG 8
UL / CSA maximum 1-phase motor rating							
Full load current	120 V AC	13.8 A	16 A	20 A	24 A	24 A	24 A
	240 V AC	10 A	12 A	17 A	17 A	28 A	28 A
Horse power rating	120 V AC	3/4 hp	1 hp	1-1/2 hp	2 hp	2 hp	2 hp
	240 V AC	1-1/2 hp	2 hp	3 hp	3 hp	5 hp	5 hp
UL / CSA maximum 3-phase motor rating							
Full load current (1)	200-208 V AC	7.8 A	11 A	17.5 A	25.3 A	32.2 A	32.2 A
	220-240 V AC	6.8 A	9.6 A	15.2 A	22 A	28 A	28 A
	440-480 V AC	7.6 A	11 A	14 A	21 A	27 A	27 A
	550-600 V AC	9 A	11 A	17 A	22 A	27 A (2)	27 A (2)
Horse power rating (1)	200-208 V AC	2 hp	3 hp	5 hp	7-1/2 hp	10 hp	10 hp
	220-240 V AC	2 hp	3 hp	5 hp	7-1/2 hp	10 hp	10 hp
	440-480 V AC	5 hp	7-1/2 hp	10 hp	15 hp	20 hp	20 hp
	550-600 V AC	7-1/2 hp	10 hp	15 hp	20 hp	25 hp (2)	25 hp (2)
Max. electrical switching frequency							
For general use		600 cycles/h					
For motor use		1200 cycles/h					

(1) For the corresponding kW/A or hp/A values of 1500 r.p.m, 50 Hz or 1800 r.p.m, 60 Hz, 3-phase motors, see "Motor rated operational powers and currents".

(2) For contactors produced since week 49-2011.

General technical data

Contactor types	AC / DC operated	AF09	AF12	AF16	AF26	AF30	AF38
Rated insulation voltage Ui		690 V					
acc. to IEC 60947-4-1		600 V					
acc. to UL / CSA		6 kV					
Rated impulse withstand voltage Uimp.		6 kV					
Electromagnetic compatibility		Devices complying with IEC 60947-1 / EN 60947-1 - Environment A					
Ambient air temperature close to contactor							
Operation	Fitted with thermal overload relay	-25...+60 °C					
	Without thermal overload relay	-40...+70 °C					
Storage		-60...+80 °C					
Climatic withstand		Category B according to IEC 60947-1 Annex Q					
Maximum operating altitude (without derating)		3000 m					
Mechanical durability							
Number of operating cycles		10 millions operating cycles					
Max. switching frequency		3600 cycles/h					
Shock withstand acc. to IEC 60068-2-27 and EN 60068-2-27							
Mounting position 1							
	Shock direction	1/2 sinusoidal shock for 11 ms: no change in contact position, closed or open position					
	A	30 g					
	B1	25 g closed position / 5 g open position					
	B2	15 g					
	C1	25 g					
	C2	25 g					
Vibration withstand		5...300 Hz					
acc. to IEC 60068-2-6		4 g closed position / 2 g open position					

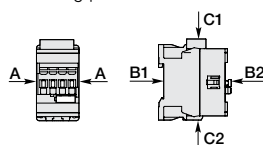

UL/NEMA/CSA Technical data

A/E/L40; A/E/F50...A/F110, A/E/F50N2...A/E/F75N3, 3-pole Utilization characteristics

Main pole - Utilization characteristics according to UL / NEMA / CSA

Contactor types	AC operated	A40	A50	A63	A75	A95	A110
	DC operated	AL40, TAL40	AE50, TAE50	AE63	AE75, TAE75	-	-
	AC / DC operated	-	AF50	AF63	AF75	AF95	AF110
Standards		UL 508, CSA C22.2 N°14					
Max. operational voltage		600 V					
NEMA size		-	2	-	3	-	-
NEMA continuous amp rating	Thermal current	-	45 A	-	90 A	-	-
NEMA maximum horse power ratings 1-phase, 60 Hz							
	115 V AC	-	3 hp	-	-	-	-
	230 V AC	-	7-1/2	-	-	-	-
NEMA maximum horse power ratings 3-phase, 60 Hz							
	200 V AC	-	10 hp	-	25 hp	-	-
	230 V AC	-	15 hp	-	30 hp	-	-
	460 V AC	-	25 hp	-	50 hp	-	-
	575 V AC	-	25 hp	-	50 hp	-	-
UL / CSA general use rating							
600 V AC		60 A	80 A	90 A	105 A	125 A	150 A
With conductor cross-sectional area		AWG 6	AWG 4	AWG 3	AWG 2	AWG 1	AWG 1/0
UL / CSA maximum 1-phase motor rating							
Full load current	120 V AC	34 A	34 A	56 A	80 A	80 A	100 A
	240 V AC	40 A	40 A	50 A	68 A	88 A	110 A
Horse power rating	120 V AC	3 hp	3 hp	5 hp	7.5 hp	7.5 hp	10 hp
	240 V AC	7.5 hp	7.5 hp	10 hp	15 hp	20 hp	25 hp
UL / CSA maximum 3-phase motor rating							
Full load current (1)	200-208 V AC	32.2 A	48.3 A	62.1 A	78.2 A	92 A	92 A
	220-240 V AC	42 A	54 A	68 A	80 A	80 A	104 A
	440-480 V AC	40 A	52 A	77 A	77 A	77 A	96 A
	550-600 V AC	41 A	52 A	77 A	77 A	77 A	99 A
Horse power rating (1)	200-208 V AC	10 hp	15 hp	20 hp	25 hp	30 hp	30 hp
	220-240 V AC	15 hp	20 hp	25 hp	30 hp	30 hp	40 hp
	440-480 V AC	30 hp	40 hp	60 hp	60 hp	60 hp	75 hp
	550-600 V AC	40 hp	50 hp	75 hp	75 hp	75 hp	100 hp
Max. electrical switching frequency							
For general use		600 cycles/h	600 cycles/h (300 for AF..., AE...)			300 cycles/h	-
For motor use		1200 cycles/h	600 cycles/h (300 for AF..., AE...)			300 cycles/h	-

(1) For the corresponding kW/A or hp/A values of 1500 r.p.m, 50 Hz or 1800 r.p.m, 60 Hz, 3-phase motors, see "Motor rated operational powers and currents".

General technical data

Contactor types	AC operated	A40	A50	A63	A75	A95	A110
	DC operated	AL40, TAL40	AE50, TAE50	AE63	AE75, TAE75	-	-
	AC / DC operated	-	AF50	AF63	AF75	AF95	AF110
Rated insulation voltage Ui		1000 V					
acc. to IEC 60947-4-1		600 V					
acc. to UL		8 kV					
Rated impulse withstand voltage Uimp.		8 kV					
Electromagnetic compatibility		AF contactors complying with IEC 60947-1 / EN 60947-1 - Environment A					
Ambient air temperature close to contactor							
Operation	Fitted with thermal overload relay	-25...+55 °C					
	Without thermal overload relay	-40...+70 °C (55 °C max. for TAL..., and TAE... contactor)					
Storage		-60...+80 °C					-40...+70 °C
Climatic withstand		acc. to IEC 60068-2-30 and 60068-2-11 UTE C 63-100 specification II					acc. to IEC 60068-2-30
Maximum operating altitude (without derating)		3000 m					
Mechanical durability							
Number of operating cycles		10 millions operating cycles (5 millions for AE... and TAE...)					
Max. switching frequency		3600 cycles/h (300 for AF contactors)					
Shock withstand acc. to IEC 60068-2-27 and EN 60068-2-27							
Mounting position 1							
	Shock direction	1/2 sinusoidal shock for 11 ms: no change in contact position, closed or open position (2)					
	A	20 g					<div style="border: 1px solid black; padding: 2px;"> For AL40, TAL40 A : 20 g closed position / 10 g open position B1 : 15 g closed position / 5 g open position B2 : 10 g closed position / 10 g open position C1 : 20 g closed position / 8 g open position C2 : 14 g closed position / 8 g open position </div>
	B1	10 g closed position / 5 g open position					
	B2	15 g					
	C1	20 g					
	C2	20 g					

(2) These values are not valid for rail mounting with contactors A95 ... A110 and AF95 ... AF110.

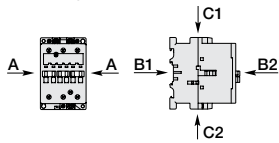

UL/NEMA/CSA Technical data

A/F145...A/F300; A/F145N4...A/F260N5, 3-pole

Utilization characteristics

Main pole - Utilization characteristics according to UL / NEMA / CSA

Contactor types	AC operated	A145	A185	A210	A260	A300
	AC / DC operated	AF145	AF185	AF210	AF260	AF300
Standards		UL 508, CSA C22.2 N°14				
Max. operational voltage		600 V				
NEMA size		4	-	-	5	-
NEMA maximum horse power ratings 1-phase, 60 Hz	115 V AC	-	-	-	-	-
	230 V AC	-	-	-	-	-
NEMA maximum horse power ratings 3-phase, 60 Hz	200 V AC	40 hp			75 hp	
	230 V AC	50 hp			100 hp	
	460 V AC	100 hp			200 hp	
	575 V AC	200 hp			200 hp	
UL / CSA general use rating	600 V AC	230 A	250 A	300 A	350 A	400 A
UL / CSA maximum 1-phase motor rating						
Full load current	240 V AC	-	-	-	-	-
Horse power rating	240 V AC	-	-	-	-	-
UL / CSA maximum 3-phase motor rating						
Full load current (1)	200-208 V AC	119.6 A	149.5 A	166.8 A	220.8 A	285.2 A
	220-240 V AC	130 A	145 A	192 A	248 A	248 A
	440-480 V AC	124 A	156 A	180 A	240 A	302 A
	550-600 V AC	125 A	144 A	192 A	242 A	289 A
Horse power rating (1)	200-208 V AC	40 hp	50 hp	60 hp	75 hp	100 hp
	220-240 V AC	50 hp	60 hp	75 hp	100 hp	100 hp
	440-480 V AC	100 hp	125 hp	150 hp	200 hp	250 hp
	550-600 V AC	125 hp	150 hp	200 hp	250 hp	300 hp
Max. electrical switching frequency						
For general use		300 cycles/h				
For motor use		300 cycles/h				

(1) For the corresponding kW/A or hp/A values of 1500 r.p.m, 50 Hz or 1800 r.p.m, 60 Hz, 3-phase motors, see "Motor rated operational powers and currents".

General technical data

Contactor types	AC operated	A145	A185	A210	A260	A300
	AC / DC operated	AF145	AF185	AF210	AF260	AF300
Rated insulation voltage Ui		1000 V				
acc. to IEC 60947-4-1		1000 V				
acc. to UL		600 V				
Rated impulse withstand voltage Uimp.		8 kV				
Electromagnetic compatibility		AF contactors complying with IEC 60947-1 / EN 60947-1 - Environment A				
Ambient air temperature close to contactor						
Operation	Fitted with thermal overload relay	-25 to +55 °C				
	Fitted with electronic overload relay	-25 to +70 °C				
	Without electronic overload relay	-40 to +70 °C				
Storage		-40 to +70 °C				
Climatic withstand		acc. to IEC 60068-2-30				
Maximum operating altitude (without derating)		3000 m				
Mechanical durability						
Number of operating cycles		5 millions operating cycles				
Max. switching frequency		3600 cycles/h (300 for AF... contactors)				
Shock withstand acc. to IEC 60068-2-27 and EN 60068-2-27						
Mounting position 1						
	Shock direction	1/2 sinusoidal shock for 30 ms: no change in contact position, closed or open position				
	A	5 g				
	B1	5 g				
	B2	5 g				
	C1	5 g				
	C2	5 g				

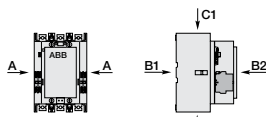

UL/NEMA/CSA Technical data

AF400...AF2050; AF460N6...AF1650N8, 3-pole

Utilization characteristics

Main pole - Utilization characteristics according to UL / NEMA / CSA

Contactor types	AC / DC operated	AF400	AF460	AF580	AF750	AF1250	AF1350	AF1650	AF2050	
Standards		UL 508, CSA C22.2 N°14								
Max. operational voltage		600 V								
NEMA size		-	6	-	7	-	-	8	-	
NEMA maximum horse power ratings 1-phase, 60 Hz										
	115 V AC	-	-	-	-	-	-	-	-	
	230 V AC	-	-	-	-	-	-	-	-	
NEMA maximum horse power ratings 3-phase, 60 Hz										
	200 V AC	-	150 hp	-	-	-	-	-	-	
	230 V AC	-	200 hp	-	300 hp	-	-	450 hp	-	
	460 V AC	-	400 hp	-	600 hp	-	-	900 hp	-	
	575 V AC	-	400 hp	-	600 hp	-	-	900 hp	-	
UL / CSA general use rating										
600 V AC		550 A	650 A	750 A	900 A	1210 A	1350 A	1650 A	2100 A	
UL / CSA maximum 1-phase motor rating										
Full load current	120 V AC	-	-	-	-	-	-	-	-	
	240 V AC	-	-	-	-	-	-	-	-	
Horse power rating	120 V AC	-	-	-	-	-	-	-	-	
	240 V AC	-	-	-	-	-	-	-	-	
UL / CSA maximum 3-phase motor rating										
Full load current (1)	200-208 V AC	358.8 A	414 A	552 A	692.3 A	-	954 A	1030 A	-	
	220-240 V AC	360 A	480 A	604 A	722 A	-	954 A	1030 A	-	
	440-480 V AC	414 A	477 A	590 A	722 A	-	954 A	1030 A	-	
	550-600 V AC	382 A	472 A	578 A	672 A	-	944 A	1050 A	-	
Horse power rating (1)	200-208 V AC	125 hp	150 hp	200 hp	250 hp	-	-	-	-	
	220-240 V AC	150 hp	200 hp	250 hp	300 hp	-	400 A	450 hp	-	
	440-480 V AC	350 hp	400 hp	500 hp	600 hp	-	800 A	900 hp	-	
	550-600 V AC	400 hp	500 hp	600 hp	700 hp	-	1000 A	1150 hp	-	
Short-circuit protection device for contactors										
without thermal overload relay - Motor protection excluded										
Fuse rating		1000 A		1200 A		Please consult us for coordination with circuit-breaker				
Fuse type, 600 V		L								
Max. electrical switching frequency										
For general use		300 cycles/h					60 cycles/h			
For motor use		300 cycles/h					60 cycles/h			

(1) For the corresponding kW/A or hp/A values of 1500 r.p.m., 50 Hz or 1800 r.p.m., 60 Hz, 3-phase motors, see "Motor rated operational powers and currents".

General technical data

Contactor types	AC / DC operated	AF400	AF460	AF580	AF750	AF1250	AF1350	AF1650	AF2050	
Rated insulation voltage Ui										
acc. to IEC 60947-4-1		1000 V								
acc. to UL		600 V								
Rated impulse withstand voltage Uimp.		8 kV								
Electromagnetic compatibility		AF contactors complying with IEC 60947-1 / EN 60947-1 - Environment A								
Ambient air temperature close to contactor										
Operation	Fitted with electronic overload relay	-25 to +70 °C								
	Without electronic overload relay	-40 to +70 °C								
Storage		-40 to +70 °C								
Climatic withstand		acc. to IEC 60068-2-30								
Maximum operating altitude (without derating)		3000 m								
Mechanical durability										
Number of operating cycles		3 millions operating cycles				0.5 million operating cycles				
Max. switching frequency		300 cycles/h					60 cycles/h			
Shock withstand										
acc. to IEC 60068-2-27 and EN 60068-2-27										
Mounting position 1										
	Shock direction	1/2 sinusoidal shock for 30 ms: no change in contact position, closed or open position								
	A	5 g								
	B1	5 g								
	B2	5 g								
	C1	5 g								
	C2	5 g								

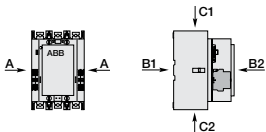

General technical data

AF09(Z)...AF38(Z), 3-pole

Coil & mounting characteristics

Magnet system characteristics

Contactor types		AC / DC operated	AF09	AF12	AF16	AF26	AF30	AF38
Coil operating limits acc. to IEC 60947-4-1	AC supply		At $\theta \leq 60^\circ\text{C}$ $0.85 \times U_c \text{ min...} 1.1 \times U_c \text{ max.}$ At $\theta \leq 70^\circ\text{C}$ $0.85 \times U_c \text{ min...} U_c \text{ max.}$					
	DC supply		At $\theta \leq 60^\circ\text{C}$ $0.85 \times U_c \text{ min...} 1.1 \times U_c \text{ max.}$ At $\theta \leq 70^\circ\text{C}$ (AF) $0.85 \times U_c \text{ min...} U_c \text{ max.}$ - (AF..Z) $0.85 \times U_c \text{ min...} 1.1 \times U_c \text{ max.}$					
AC control voltage 50/60 Hz	Rated control circuit voltage U_c		24...500 V AC					
	Coil consumption	Average pull-in value	(AF) 50 VA - (AF..Z) 16 VA					
		Average holding value	(AF) 2.2 VA / 2 W - (AF..Z) 1.7 VA / 1.5 W					
DC control voltage	Rated control circuit voltage U_c		12...500 V DC					
	Coil consumption	Average pull-in value	(AF) 50 W - (AF..Z) 12...16 W					
		Average holding value	(AF) 2 W - (AF..Z) 1.7 W					
PLC-output control		(AF..Z) $\geq 500 \text{ mA}$ 24 V DC						
Drop-out voltage		$\leq 60\%$ of $U_c \text{ min.}$						
Voltage sag immunity acc. to SEMI F47-0706		(AF..Z) conditions of use on request						
Dips withstand $-20^\circ\text{C} \leq \theta \leq +60^\circ\text{C}$		(AF..Z) 22 ms average						
Operating time								
Between coil energization and:	N.O. contact closing	40...95 ms						
	N.C. contact opening	38...90 ms						
Between coil de-energization and:	N.O. contact opening	11...95 ms						
	N.C. contact closing	13...98 ms						

Mounting characteristics and conditions for use

Contactor types		AC / DC operated	AF09	AF12	AF16	AF26	AF30	AF38
Mounting positions								
Mounting distances			Max. N.C. built-in and add-on N.C. auxiliary contacts: see accessory fitting details for a 3-pole contactor AF09 ... AF38					
Fixing	On rail according to IEC 60715, EN 60715		The contactors can be assembled side by side 35 x 7.5 mm or 35 x 15 mm					
	By screws (not supplied)		2 x M4 screws placed diagonally					

General technical data

A40...A110, 3-pole

Coil & mounting characteristics

Magnet system characteristics

Contactor types	AC operated	A40	A50	A63	A75	A95	A110	
Coil operating limits acc. to IEC 60947-4-1	AC supply	At $\theta \leq 55^\circ\text{C}$ 0.85...1.1 x U_c					at $\theta \leq 70^\circ\text{C}$ 0.85...1.1 x U_c	
AC control voltage	Rated control circuit voltage U_c	at 50 Hz 24...690 V						
		at 60 Hz 24...690 V						
Coil consumption	Average pull-in value	50 Hz	120 VA	180 VA			350 VA	
		60 Hz	140 VA	210 VA			450 VA	
	50/60 Hz (1)	125 VA / 120 VA	190 VA / 180 VA			410 VA / 365 VA		
	Average holding value	50 Hz	12 VA / 3 W	18 VA / 5.5 W			22 VA / 6.5 W	
		60 Hz	12 VA / 3 W	18 VA / 5.5 W			26 VA / 8 W	
50/60 Hz (1)		12 VA / 3 W	18 VA / 5.5 W			27 VA / 7.5 W		
Drop-out voltage		Approx. 40...65 % of U_c						
Operating time								
Between coil energization and:	N.O. contact closing	8...21 ms	8...27 ms			10...25 ms		
	N.C. contact opening	6...18 ms	7...22 ms			7...22 ms		
Between coil de-energization and:	N.O. contact opening	4...11 ms	4...11 ms			7...15 ms		
	N.C. contact closing	7...14 ms	7...14 ms			10...18 ms		

(1) 50/60 Hz coils: see "Voltage code table".

Mounting characteristics and conditions for use

Contactor types	AC operated	A40	A50	A63	A75	A95	A110
Mounting positions							
Control voltage / Ambient temperature		Max. built-in and add-on N.O. or N.C. auxiliary contacts: see accessory fitting details for 3-pole contactor A40 ... A110					
Mounting positions	1, 1±30°, 2, 3, 4, 5	at $\theta \leq 55^\circ\text{C}$	0.85...1.1 x U_c			0.85...1.1 x U_c	
		at $\theta \leq 70^\circ\text{C}$	U_c			0.85...1.1 x U_c	
	6	at $\theta \leq 55^\circ\text{C}$	0.95...1.1 x U_c			Unauthorized	
		at $\theta \leq 70^\circ\text{C}$	Unauthorized			Unauthorized	
Mounting distances		The contactors can be assembled side by side					
Fixing	On rail according to IEC 60715, EN 60715	35 x 7.5 mm or 35 x 15 mm	35 x 15 mm or 75 x 25 mm				-
	By screws (not supplied)	2 x M4 screws placed diagonally	2 x M6 screws placed diagonally			2 x M6 screws placed diagonally	

General technical data

AL40, AE50...AE75, 3-pole

Coil & mounting characteristics

Magnet system characteristics

Contactor types		DC operated	AL40	AE50	AE63	AE75
Coil operating limits <small>acc. to IEC 60947-4-1</small>		DC supply	at $\theta \leq 55\text{ °C}$ $0.85 \dots 1.1 \times U_c$ Please also refer to "Mounting characteristics and conditions for use"			
DC control voltage	Rated control circuit voltage U_c		12...250 V DC			
	Coil consumption	Average pull-in value	3.5 W	200 W		
		Average holding value	3.5 W	4 W		
Drop-out voltage			approx. 10...30 % of U_c	approx. 15...40 % of U_c		
Coil time constant	Open	L/R	38 ms	3 ms		
	Closed	L/R	62 ms	15 ms		
Operating time						
Between coil energization and:		N.O. contact closing	55...110 ms	13...30 ms		
		N.C. contact opening	25...75 ms	10...27 ms		
Between coil de-energization and:		N.O. contact opening (1)	12...18 ms	5...15 ms		
		N.C. contact closing (1)	18...28 ms	8...18 ms		

(1) The use of surge suppressors increases the opening time with a factor of 1.1 to 1.5 for a RV5 surge suppressor and a factor of 1.5 to 3 for a RT5 surge suppressor.

Mounting characteristics and conditions for use

Contactor types		DC operated	AL40	AE50	AE63	AE75
Mounting positions						
Control voltage / Ambient temperature			Max. built-in and add-on N.O. or N.C. auxiliary contacts: see accessory fitting details for 3-pole contactor AL40, AE50 ... AE75			
Mounting positions	1, $1 \pm 30^\circ$, 2, 3, 4, 5	at $\theta \leq 55\text{ °C}$	0.85 x $U_c \dots 1.1 \times U_c$			
		at $\theta \leq 70\text{ °C}$	U_c			
	6	at $\theta \leq 55\text{ °C}$	Unauthorized			
		at $\theta \leq 70\text{ °C}$	Unauthorized			
Mounting distances			The contactors can be assembled side by side			
Fixing	On rail according to IEC 60715, EN 60715		35 x 7.5 mm or 35 x 15 mm	35 x 15 mm or 75 x 25 mm		
	By screws (not supplied)		2 x M4 screws placed diagonally	2 x M6 screws placed diagonally		

General technical data

AF50...AF110, 3-pole

Coil & mounting characteristics

Magnet system characteristics

Contactor types		AC / DC operated	AF50	AF63	AF75	AF95	AF110	
Coil operating limits acc. to IEC 60947-4-1		AC or DC supply	At $\theta \leq 70^\circ\text{C}$ $0.85 \times U_c$ min... $1.1 \times U_c$ max. Please also refer to "Mounting characteristics and conditions for use"					
AC control voltage 50/60 Hz	Rated control circuit voltage U_c		48...250 V 50/60 Hz					
	Coil consumption	Average pull-in value	210 VA					350 VA
		Average holding value	7 VA / 2.8 W					7 VA / 3.5 W
DC control voltage	Rated control circuit voltage U_c		20...250 V DC					
	Coil consumption	Average pull-in value	190 W					400 W
		Average holding value	2.8 W					2 W
Drop-out voltage			55 % of U_c min.					
Voltage sag immunity acc. to SEMI F47			Conditions of use on request					
Dips withstand			≥ 20 ms					
Operating time								
Between coil energization and:		N.O. contact closing	30...100 ms				30...80 ms	
		N.C. contact opening	27...95 ms				27...77 ms	
Between coil de-energization and:		N.O. contact opening	30...110 ms				55...125 ms	
		N.C. contact closing	35...115 ms				60...130 ms	

Mounting characteristics and conditions for use

Contactor types		AC / DC operated	AF50	AF63	AF75	AF95	AF110
Mounting positions							
Control voltage / Ambient temperature			Max. built-in and add-on N.O. or N.C. auxiliary contacts: see accessory fitting details for 3-pole contactor AF50 ... AF110				
Mounting positions	1, 1±30°, 2, 3, 4, 5 6	at $\theta \leq 70^\circ\text{C}$	0.85 x U_c min...1.1 x U_c max. Unauthorized				
Mounting distances			The contactors can be assembled side by side				
Fixing	On rail according to IEC 60715, EN 60715		35 x 15 mm or 75 x 25 mm				-
	By screws (not supplied)		2 x M6 screws placed diagonally				

General technical data

A145...A300, 3-pole

Coil & mounting characteristics

Magnet system characteristics

Contactor types	AC operated	A145	A185	A210	A260	A300
Coil operating limits <small>acc. to IEC 60947-4-1</small>	AC supply	At $\theta \leq 70^\circ\text{C}$ $0.85 \dots 1.1 \times U_c$ Please also refer to "Mounting characteristics and conditions for use"				
AC control voltage	Rated control circuit voltage U_c	at 50 Hz	24...690 V			
		at 60 Hz	24...690 V			
Coil consumption	Average pull-in value	50 Hz	550 VA			1350 VA
		60 Hz	600 VA			1550 VA
	50/60 Hz (1)	700 VA / 650 VA			1700 VA / 1550 VA	
	Average holding value	50 Hz	35 VA / 11 W			60 VA / 16 W
		60 Hz	40 VA / 12 W			65 VA / 19 W
50/60 Hz (1)	44 VA / 13 W			80 VA / 21 W		
Drop-out voltage		Approx. 40...65 % of U_c min.				
Operating time	Between coil energization and:	N.O. contact closing	13...27 ms			17...35 ms
		N.C. contact opening	8...22 ms			12...30 ms
	Between coil de-energization and:	N.O. contact opening	5...10 ms			7...13 ms
		N.C. contact closing	9...13 ms			10...16 ms

(1) 50/60 Hz coils: see "Voltage code table".

Mounting characteristics and conditions for use

Contactor types	AC operated	A145	A185	A210	A260	A300	
Mounting positions							
Control voltage / Ambient temperature		Max. add-on N.O. or N.C. auxiliary contacts: see accessory fitting details for 3-pole contactor A145 ... A300					
Mounting positions	1, $1 \pm 30^\circ$, 2, 3, 4, 5 6	at $\theta \leq 70^\circ\text{C}$	0.85 x $U_c \dots 1.1 \times U_c$			Unauthorized	
			The contactors can be assembled side by side				
Mounting distances	On rail according to IEC 60715, EN 60715	-					
	By screws (not supplied)	4 x M5					

General technical data

AF145...AF300, 3-pole

Coil & mounting characteristics

Magnet system characteristics

Contactor types	AC / DC operated	AF145	AF185	AF210	AF260	AF300
Coil operating limits acc. to IEC 60947-4-1	AC or DC supply	At $\theta \leq 70^\circ\text{C}$ $0.85 \times U_c \text{ min...} 1.1 \times U_c \text{ max.}$ Please also refer to "Mounting characteristics and conditions for use"				
AC control voltage 50/60 Hz	Rated control circuit voltage U_c	48...250 V AC			470 VA	
	Coil consumption	Average pull-in value 12 VA / 3.5 W			10 VA / 2.5 W	
		Average holding value				
DC control voltage	Rated control circuit voltage U_c	20...250 V DC				
	Coil consumption	Average pull-in value 500 W			520 W	
		Average holding value 2 W			2 W	
Drop-out voltage		55 % of $U_c \text{ min.}$				
Voltage sag immunity acc. to SEMI F47		Conditions of use on request				
Dips withstand		$\geq 20 \text{ ms}$				
Operating time						
Between coil energization and:	N.O. contact closing	30...115 ms				
	N.C. contact opening	30...115 ms				
Between coil de-energization and:	N.O. contact opening	25...80 ms				
	N.C. contact closing	25...80 ms				

Mounting characteristics and conditions for use

Contactor types	AC / DC operated	AF145	AF185	AF210	AF260	AF300
Mounting positions						
Control voltage / Ambient temperature		Max. add-on N.O. or N.C. auxiliary contacts: see accessory fitting details for 3-pole contactor AF145 ... AF2050				
Mounting positions	1, 1±30°, 2, 3, 4, 5 6	at $\theta \leq 70^\circ\text{C}$ $0.85 \times U_c \text{ min...} 1.1 \times U_c \text{ max.}$ Unauthorized				
Mounting distances		The contactors can be assembled side by side				
Fixing	On rail according to IEC 60715, EN 60715	-				
	By screws (not supplied)	4 x M5				

General technical data

AF400...AF2050, 3-pole

Coil & mounting characteristics

Magnet system characteristics

Contactor types	AC / DC operated	AF400	AF460	AF580	AF750	AF1250	AF1350	AF1650	AF2050
Coil operating limits acc. to IEC 60947-4-1	AC or DC supply	At $\theta \leq 70^\circ\text{C}$ $0.85 \times U_c$ min... $1.1 \times U_c$ max. Please also refer to "Mounting characteristics and conditions for use"							
AC control voltage 50/60 Hz	Rated control circuit voltage U_c	48...500 V AC					100...250 V		
	Coil consumption	Average pull-in value	890 VA		850 VA		1900 VA		
		Average holding value	12 VA / 4 W		12 VA / 4.5 W		48 VA / 17 W		
DC control voltage	Rated control circuit voltage U_c	24...500 V DC					100...250 V		
	Coil consumption	Average pull-in value	990 W		950 W		1700 W		
		Average holding value	4 W		4.5 W		16 W		
Drop-out voltage		55 % of U_c min.							
Voltage sag immunity acc. to SEMI F47		Conditions of use on request							
Dips withstand		≥ 20 ms							
Operating time									
Coil supply between A1 - A2 Between coil energization and:	N.O. contact closing	50...120 ms					50...80 ms		
	N.C. contact opening	50...120 ms					50...80 ms		
Between coil de-energization and:	N.O. contact opening	33...70 ms					35...55 ms		
	N.C. contact closing	33...70 ms					35...55 ms		
Control input for PLC's Between coil energization and:	N.O. contact closing	40...60 ms		40...90 ms		40...65 ms			
	N.C. contact opening	40...60 ms		40...90 ms		40...65 ms			
Between coil de-energization and:	N.O. contact opening	10...30 ms				10...30 ms			
	N.C. contact closing	10...30 ms				10...30 ms			

Mounting characteristics and conditions for use















Contactor types	AC / DC operated	AF400	AF460	AF580	AF750	AF1250	AF1350	AF1650	AF2050
Mounting positions									
		Max. add-on N.O. or N.C. auxiliary contacts: see accessory fitting details for 3-pole contactor AF400 ... AF2050							
Control voltage / Ambient temperature	Mounting positions 1, 1±30°, 2, 3, 4, 5 6	at $\theta \leq 70^\circ\text{C}$		0.85 x U_c min...1.1 x U_c max.					
		Unauthorized							
Mounting distances		The contactors can be assembled side by side							
Fixing	On rail according to IEC 60715, EN 60715	-							
	By screws (not supplied)	4 x M5		4 x M6		4 x M8			

General technical data

AF09(Z)...AF38(Z), 3-pole

Terminal characteristics

Connecting characteristics













Contactor types	AC / DC operated	AF09	AF12	AF16	AF26	AF30	AF38
Main terminals		 Screw terminals with cable clamp					
Connection capacity (min. ... max.)							
Main conductors (poles)							
	Rigid	} 1 x	1...6 mm ²			2.5...10 mm ²	
	Solid ($\leq 4 \text{ mm}^2$) Stranded ($\geq 6 \text{ mm}^2$)		1...6 mm ²			2.5...10 mm ²	
	Flexible with non insulated ferrule	1 x	0.75...6 mm ²			1.5...10 mm ²	
		2 x	0.75...6 mm ²			1.5...10 mm ²	
	Flexible with insulated ferrule	1 x	0.75...4 mm ²			1.5...10 mm ²	
		2 x	0.75...2.5 mm ²			1.5...4 mm ²	
	Bars or lugs	L <	9.6 mm			12.5 mm	
Connection capacity acc. to UL/CSA (solid/stranded)		1 or 2 x	AWG 16...10			AWG 14...8	
Stripping length		10 mm			14 mm		
Tightening torque		1.5 Nm / 13 lb.in			2.5 Nm / 22 lb.in		
Auxiliary conductors (built-in auxiliary terminals + coil terminals)							
	Rigid solid	1 x	1...2.5 mm ²				
		2 x	1...2.5 mm ²				
	Flexible with non insulated ferrule	1 x	0.75...2.5 mm ²				
		2 x	0.75...2.5 mm ²				
	Flexible with insulated ferrule	1 x	0.75...2.5 mm ²				
		2 x	0.75...1.5 mm ²				
	Lugs	L <	8 mm				
Connection capacity acc. to UL/CSA (solid/stranded)		1 or 2 x	AWG 18...14				
Stripping length		10 mm					
Tightening torque							
Coil terminals		1.2 Nm / 11 lb.in					
Built-in auxiliary terminals		1.2 Nm / 11 lb.in					
Degree of protection							
acc. to IEC 60947-1 / EN 60947-1 and IEC 60529 / EN 60529							
Main terminals		IP20					
Coil terminals		IP20					
Built-in auxiliary terminals		IP20					
Screw terminals		Delivered in open position, screws of unused terminals must be tightened					
Main terminals		M3.5			M4		
		Screwdriver type	Flat Ø 5.5 / Pozidriv 2			Flat Ø 6.5 / Pozidriv 2	
Coil terminals		M3.5					
		Screwdriver type	Flat Ø 5.5 / Pozidriv 2				
Built-in auxiliary terminals		M3.5					
		Screwdriver type	Flat Ø 5.5 / Pozidriv 2				

General technical data

A/E/L40, A/E/F50...A/F110, 3-pole

Terminal characteristics

Connecting characteristics

Contactor types	AC operated	A40	A50	A63	A75	A95	A110
	DC operated	AL40	AE50	AE63	AE75	–	–
	AC / DC operated	TAL40	TAE50	–	TAE75	–	–
	AC / DC operated	–	AF50	AF63	AF75	AF95	AF110
Main terminals							
		Screw terminals with double connector 2 x (5.6 x 6.5 mm)	Screw terminals with single connector (13 x 10 mm)			Screw terminals with single connector (14 x 14 mm)	
Connection capacity (min. ... max.)							
Main conductors (poles)							
	Rigid	Solid ($\leq 4 \text{ mm}^2$)	} 1 x	2.5...16 mm ²	6...50 mm ²	10...95 mm ²	
		Stranded ($\geq 6 \text{ mm}^2$)		2 x	2.5...16 mm ²	6...25 mm ²	6...35 mm ²
	Flexible with ferrule		1 x	2.5...10 mm ²	6...35 mm ²	10...70 mm ² (1)	
		2 x	2.5...10 mm ²	6...16 mm ²	6...35 mm ² (1)		
	Bars or lugs		L \leq	–	–	30 mm (2)	
		L $>$	–	–	6 mm		
Connection capacity acc. to UL/CSA (solid/stranded)			1 or 2 x	AWG 8...4	AWG 8...1	AWG 6...2/0	
Tightening torque		Recommended		2.30 Nm / 20 lb.in	4.00 Nm / 35 lb.in	8 Nm / 71 lb.in	
		Max.		2.60 Nm	4.50 Nm	9 Nm	
Auxiliary conductors							
(built-in auxiliary terminals + coil terminals)							
	Rigid solid		1 x	1...4 mm ²		0.75...2.5 mm ²	
		2 x	1...4 mm ²			0.75...2.5 mm ²	
	Flexible with ferrule		1 x	0.75...2.5 mm ²	1...2.5 mm ²	0.75...2.5 mm ²	
		2 x	0.75...2.5 mm ²				
	Lugs		L \leq	8 mm			
		L $>$		3.7 mm			
Connection capacity acc. to UL/CSA (solid/stranded)			1 or 2 x	AWG 18...14			
Tightening torque							
Coil terminals		Recommended		1.00 Nm / 9 lb.in			
		Max.		1.20 Nm			
Built-in auxiliary terminals		Recommended		1.00 Nm / 9 lb.in	–	–	
		Max.		1.20 Nm	–	–	
Degree of protection							
acc. to IEC 60947-1 / EN 60947-1 and IEC 60529 / EN 60529							
Main terminals				IP20	IP10		
Coil terminals				IP20			
Built-in auxiliary terminals				IP20	–	–	
Screw terminals							
Main terminals				Delivered in open position, screws of unused terminals must be tightened			
				M5	M6	M8	
			Screwdriver type	Flat \varnothing 6.5 / Pozidriv 2		Hexagon socket (s = 4 mm)	
Coil terminals			Screwdriver type	M3.5			
			Screwdriver type	Flat \varnothing 5.5 / Pozidriv 2			
Built-in auxiliary terminals			Screwdriver type	M3.5	–	–	
			Screwdriver type	Flat \varnothing 5.5 / Pozidriv 2	–	–	

(1) A(F)95 / A(F)110: use flexible without ferrule.









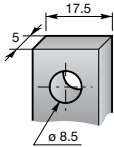
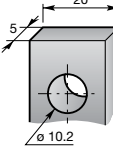

(2) With LW110 enlargement piece, see "Accessories".

General technical data

A/F145...A/F300, 3-pole

Terminal characteristics

Connecting characteristics

Contactor types	AC operated		A145	A185	A210	A260	A300	
	AC / DC operated		AF145	AF185	AF210	AF260	AF300	
Main terminals Flat type								
Connection capacity (min. ... max.)								
Main conductors (poles)								
 Rigid with connector	Single for Cu cable		6...185 mm ²		16...240 mm ²			
 Rigid with connector	Single for Al/Cu cable		25...150 mm ²		120...240 mm ²			
 Rigid with connector	Double for Al/Cu cable		-		2 x 95...120 mm ²			
 Bars or lugs		L ≤	24 mm		32 mm			
		Ø >	8 mm		10 mm			
Connection capacity acc. to UL/GSA			6 - 250 MCM x 1		4 - 500 MCM x 1 (1)			
Tightening torque	Recommended		18 Nm / 160 lb.in		28 Nm / 247 lb.in			
	Max.		20 Nm		30 Nm			
Auxiliary conductors (coil terminals)								
 Rigid solid		1 x	1...4 mm ²					
 Rigid solid		2 x	1...4 mm ²					
 Flexible with ferrule		1 x	0.75...2.5 mm ²					
 Flexible with ferrule		2 x	0.75...2.5 mm ²					
 Lugs		L ≤	8 mm					
		l >	3.7 mm					
Connection capacity acc. to UL/CSA (solid/stranded)		1 or 2 x	AWG 18...14					
Tightening torque	Recommended		1.00 Nm / 9 lb.in					
	Max.		1.20 Nm					
Degree of protection								
acc. to IEC 60947-1 / EN 60947-1 and IEC 60529 / EN 60529								
Main terminals					IP00			
Coil terminals					IP20			
Screw terminals								
Main terminals			M8		M10			
			Screws and bolts					
Coil terminals (delivered in open position)			M3.5					
			Screwdriver type		Flat Ø 5.5 mm / Pozidriv 2			







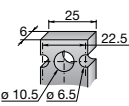
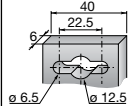
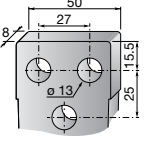
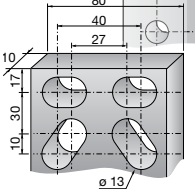
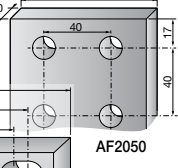

(1) With LW110 enlargement piece: see "Accessories".

General technical data

AF400...AF2050, 3-pole

Terminal characteristics

Connecting characteristics

Contactor types	AC / DC operated	AF400	AF460	AF580	AF750	AF1250	AF1350	AF1650	AF2050
Main terminals Flat type									
Connection capacity (min. ... max.)									
Main conductors (poles)									
 Rigid with connector	Single for Cu cable	240 mm ²		300 mm ²					
 Rigid with connector	Single for Al/Cu cable	240 mm ²		300 mm ²					
 Rigid with connector	Double for Al/Cu cable	2 x 240 mm ²		3 x 185 mm ²					
 Bars or lugs	L ≤	47 mm		52 mm			100 mm		
	Ø >	10 mm		12 mm			12 mm		
Connection capacity acc. to UL/CSA		250 - 500 MCM x 2		2/0 - 500 MCM x 2			1/0 - 750 MCM x 4		
Tightening torque	Recommended	35 Nm / 310 lb.in		45 Nm / 398 lb.in			45 Nm / 398 lb.in		
	Max.	40 Nm		49 Nm			49 Nm		
Auxiliary conductors (coil terminals)									
 Rigid solid	1 x	1...4 mm ²							
	2 x	1...4 mm ²							
 Flexible with ferrule	1 x	0.75...2.5 mm ²							
	2 x	0.75...2.5 mm ²							
 Lugs	L ≤	8 mm							
	L >	3,7 mm							
Connection capacity acc. to UL/CSA (solid/stranded)	1 or 2 x	AWG 18...14							
Tightening torque	Recommended	1.00 Nm / 9 lb.in							
	Max.	1.20 Nm							
Degree of protection acc. to IEC 60947-1 / EN 60947-1 and IEC 60529 / EN 60529									
Main terminals		IP00							
Coil terminals		IP20							
Screw terminals									
Main terminals		M10		M12					
		Screws and bolts							
Coil terminals (delivered in open position)		M3.5							
	Screwdriver type	Flat Ø 5.5 mm / Pozidriv 2							

General technical data

AF09(Z)...AF38(Z), 3-pole

Built-in auxiliary contacts

Built-in auxiliary contacts according to IEC

Contactor types	AC / DC operated	AF09	AF12	AF16	AF26	AF30	AF38
Rated operational voltage U _e max.		690 V					
Rated frequency (without derating)		50 / 60 Hz					
Conventional free air thermal current I _{th} - θ ≤ 40 °C		16 A					
le / Rated operational current AC-15 acc. to IEC 60947-5-1		6 A					
	24-127 V 50/60 Hz	4 A					
	220-240 V 50/60 Hz	3 A					
	400-440 V 50/60 Hz	2 A					
	500 V 50/60 Hz	2 A					
	690 V 50/60 Hz	2 A					
Making capacity AC-15		10 x I _e AC-15 acc. to IEC 60947-5-1					
Breaking capacity AC-15		10 x I _e AC-15 acc. to IEC 60947-5-1					
le / Rated operational current DC-13 acc. to IEC 60947-5-1		6 A / 144 W					
	24 V DC	2.8 A / 134 W					
	48 V DC	1 A / 72 W					
	72 V DC	0.55 A / 60 W					
	110 V DC	0.55 A / 69 W					
	125 V DC	0.27 A / 60 W					
	220 V DC	0.27 A / 68 W					
	250 V DC	0.15 A / 60 W					
	400 V DC	0.13 A / 65 W					
	500 V DC	0.1 A / 60 W					
	600 V DC	10 A					
Short-circuit protection device gG type fuse		100 A					
Rated short-time withstand current I _{cw}	for 1.0 s	140 A					
	for 0.1 s	12 V / 3 mA					
Minimum switching capacity with failure rate acc. to IEC 60947-5-4		10 ⁻⁷					
Non-overlapping time between N.O. and N.C. contacts		≥ 2 ms					
Power dissipation per pole at 6 A		0.1 W					
Max. electrical switching frequency	AC-15	1200 cycles/h					
	DC-13	900 cycles/h					
Mechanically linked contacts acc. to annex L of IEC 60947-5-1		Built-in N.O. or N.C. auxiliary contacts and additional N.O. or N.C. auxiliary contacts (CA4, CAL4, CAT4 aux. contact blocks) are mechanically linked contacts.					
Mirror contacts acc. to annex F of IEC 60947-4-1		Built-in N.C. auxiliary contacts or additional N.C. auxiliary contacts (CA4, CAL4, CAT4 aux. contact blocks) are mirror contacts.					

Built-in auxiliary contacts according to UL / CSA

Contactor types	AC / DC operated	AF09	AF12	AF16	AF26	AF30	AF38
Max. operational voltage		600 V AC, 600 V DC					
Pilot duty		A600, Q600					
AC thermal rated current		10 A					
AC maximum volt-ampere making		7200 VA					
AC maximum volt-ampere breaking		720 VA					
DC thermal rated current		2.5 A					
DC maximum volt-ampere making-breaking		69 VA					

General technical data

A/E/L40, 3-pole

Built-in auxiliary contacts

Built-in auxiliary contacts according to IEC

Contactor types	AC operated	A40
	DC operated	AL40, TAL40
Rated operational voltage U_e max.		690 V
Rated frequency (without derating)		50/60 Hz
Conventional free air thermal current $I_{th} - \theta \leq 40^\circ\text{C}$		16 A
I_e / Rated operational current AC-15		
acc. to IEC 60947-5-1	24-127 V 50/60 Hz	6 A
	220-240 V 50/60 Hz	4 A
	380-440 V 50/60 Hz	3 A
	500 V 50/60 Hz	2 A
	690 V 50/60 Hz	2 A
Making capacity AC-15		10 x I_e AC-15 acc. to IEC 60947-5-1
Breaking capacity AC-15		10 x I_e AC-15 acc. to IEC 60947-5-1
I_e / Rated operational current DC-13		
acc. to IEC 60947-5-1	24 V DC	6 A / 144 W
	48 V DC	2.8 A / 134 W
	72 V DC	2 A / 144 W
	110 V DC	1.1 A / 121 W
	125 V DC	1.1 A / 138 W
	220 V DC	0.55 A / 121 W
	250 V DC	0.55 A / 138 W
Short-circuit protection device gG type fuse		10 A
Rated short-time withstand current I_{sw}	for 1.0 s	100 A
	for 0.1 s	140 A
Minimum switching capacity		17 V / 5 mA
with failure rate acc. to IEC 60947-5-4		$\leq 10^{-7}$ for AL40 and TAL40 contactors
Non-overlapping time between N.O. and N.C. contacts		≥ 2 ms
Power dissipation per pole at 6 A		0.1 W
Max. electrical switching frequency	AC-15	1200 cycles/h
	DC-13	900 cycles/h
Mechanically linked contacts		Built-in N.O. or N.C. auxiliary contacts and additional N.O. or N.C. auxiliary contacts of 4-pole CA5 are mechanically linked contacts.
acc. to annex L of IEC 60947-5-1		
Mirror contacts		Built-in N.C. auxiliary contacts or additional N.C. auxiliary contacts (CA5, CAL5-11) are mirror contacts.
acc. to annex F of IEC 60947-4-1		

Built-in auxiliary contacts according to UL / CSA



Contactor types	AC operated	A40
	DC operated	AL40, TAL40
Max. operational voltage		600 V AC, 600 V DC
Pilot duty		A600, P300
AC thermal rated current		10 A
AC maximum volt-ampere making		7200 VA
AC maximum volt-ampere breaking		720 VA
DC thermal rated current		5 A
DC maximum volt-ampere making-breaking		138 VA

IEC technical data

AS/L09...AS/L16, 3-pole, screw terminated

Utilization characteristics

Main pole - Utilization characteristics according to IEC

Contactor types	AC operated	AS09	AS12	AS16
	DC operated	ASL09	ASL12	ASL16
Standards	IEC 60947-1 / 60947-4-1 and EN 60947-1 / 60947-4-1			
Rated operational voltage U_e max.	690 V			
Rated frequency (without derating)	50 / 60 Hz			
Conventional free-air thermal current I_{th}				
acc. to IEC 60947-4-1, open contactors, $\theta \leq 40^\circ\text{C}$	22 A	25 A	25 A	25 A
With conductor cross-sectional area	2.5 mm ²	4 mm ²		4 mm ²
AC-1 Utilization category				
For air temperature close to contactor				
I_e / Rated operational current AC-1				
U _e max. ≤ 690 V, 50/60 Hz	$\theta \leq 40^\circ\text{C}$	22 A	24 A	24 A
	$\theta \leq 60^\circ\text{C}$	18 A	20 A	20 A
	$\theta \leq 70^\circ\text{C}$	15 A	16 A	16 A
With conductor cross-sectional area	2.5 mm ²			
AC-3 Utilization category				
For air temperature close to contactor $\theta \leq 60^\circ\text{C}$				
I_e / Max. rated operational current AC-3 (1)				
 3-phase motors	220-230-240 V	9 A	12 A	15.7 A
	400 V	9 A	12 A	15.5 A
	415 V	9 A	12 A	15.5 A
	440 V	8 A	11 A	13.6 A
	500 V	8 A	11 A	12.5 A
	690 V	5 A	7 A	9 A
	Rated operational power AC-3 (1)			
 1500 r.p.m. 50 Hz 1800 r.p.m. 60 Hz 3-phase motors	220-230-240 V	2.2 kW	3 kW	4 kW
	400 V	4 kW	5.5 kW	7.5 kW
	415 V	4 kW	5.5 kW	7.5 kW
	440 V	4 kW	5.5 kW	7.5 kW
	500 V	4 kW	5.5 kW	7.5 kW
	690 V	4 kW	5.5 kW	7.5 kW
	Rated making capacity AC-3	10 x I _e AC-3 acc. to IEC 60947-4-1		
Rated breaking capacity AC-3	8 x I _e AC-3 acc. to IEC 60947-4-1			
AC-8a Utilization category				
(without thermal overload relay - U _e 400 V 50/60 Hz - $\theta \leq 40^\circ\text{C}$)				
I_e / Rated operational current AC-8a	12 A	16 A	22 A	
Rated operational power AC-8a	5.5 kW	7.5 kW	11 kW	
Short-circuit protection device for contactors				
without thermal overload relay - Motor protection excluded (2)				
U _e ≤ 500 V AC - gG type fuse	25 A			
Rated short-time withstand current I_{cw}				
at 40 °C ambient temperature,	1 s	230 A	250 A	250 A
in free air from a cold state	10 s	100 A	124 A	124 A
	30 s	65 A	75 A	75 A
	1 min	50 A	55 A	55 A
	15 min	22 A	24 A	24 A
Maximum breaking capacity				
cos $\varphi = 0.45$	at 440 V	155 A		
	at 690 V	90 A		
Power dissipation per pole				
	I _e / AC-1	1 W	1.2 W	1.2 W
	I _e / AC-3	0.16 W	0.3 W	0.5 W
Max. electrical switching frequency				
	AC-1	600 cycles/h		
	AC-3	1200 cycles/h		
	AC-4	300 cycles/h		

(1) For the corresponding kW/A or hp/A values of 1500 r.p.m, 50 Hz or 1800 r.p.m, 60 Hz, 3-phase motors, see "Motor rated operational powers and currents".

(2) For the protection of motor starters against short circuits, see "Coordination with short-circuit protection devices".

UL/CSA Technical data

AS/L09...AS/L16, 3-pole, screw terminated

Utilization characteristics

Main pole - Utilization characteristics according to UL / CSA

Contactor types	AC operated	AS09	AS12	AS16
	DC operated	ASL09	ASL12	ASL16
Standards	UL 508, CSA C22.2 N°14			
Max. operational voltage	690 V			
UL / CSA general use rating	600 V AC			
With conductor cross-sectional area	20 A AWG 12		20 A AWG 12	
UL / CSA maximum 1-phase motor rating	Full load current			
120 V AC	7.2 A	9.8 A	13.8 A	
240 V AC	8 A	10 A	12 A	
Horse power rating	120 V AC	1/3 hp	1/2 hp	3/4 hp
240 V AC	1 hp	1-1/2 hp	2 hp	
UL / CSA maximum 3-phase motor rating	Full load current (1)			
200-208 V AC	7.8 A	7.8 A	11 A	
220-240 V AC	6.8 A	9.6 A	15.2 A	
440-480 V AC	7.6 A	11 A	14 A	
550-600 V AC	9 A	11 A	11 A	
Horse power rating (1)	200-208 V AC	2 hp	2 hp	3 hp
220-240 V AC	2 hp	3 hp	5 hp	
440-480 V AC	5 hp	7-1/2 hp	10 hp	
550-600 V AC	7-1/2 hp	10 hp	10 hp	
Max. electrical switching frequency	For general use 600 cycles/h			
For motor use	1200 cycles/h			

(1) For the corresponding kW/A or hp/A values of 1500 r.p.m, 50 Hz or 1800 r.p.m, 60 Hz, 3-phase motors, see "Motor rated operational powers and currents".

General technical data

Contactor types	AC operated	AS09	AS12	AS16
	DC operated	ASL09	ASL12	ASL16
Rated insulation voltage Ui	acc. to IEC 60947-4-1 690 V			
acc. to UL / CSA	600 V			
Rated impulse withstand voltage Uimp.	6 kV			
Ambient air temperature close to contactor	Operation			
Fitted with thermal overload relay	-25...+60 °C			
Without thermal overload relay	-40...+70 °C			
Storage	-60...+80 °C			
Climatic withstand	Category B according to IEC 60947-1 Annex Q			
Maximum operating altitude (without derating)	3000 m			
Mechanical durability	Number of operating cycles 10 millions operating cycles			
Max. switching frequency	3600 cycles/h			
Shock withstand	1/2 sinusoidal shock for 11 ms: no change in contact position, closed or open position			
acc. to IEC 60068-2-27 and EN 60068-2-27	Shock direction	AS contactors - AC operated	ASL contactors - DC operated	
Mounting position 1	A	20 g	20 g closed position / 10 g open position	
	B1	10 g closed position / 5 g open position	15 g closed position / 5 g open position	
	B2	15 g	10 g	
	C1	20 g closed position / 9 g open position	15 g closed position / 8 g open position	
	C2	20 g closed position / 14 g open position	14 g closed position / 8 g open position	
Vibration withstand acc. to IEC 60068-2-6	5...300 Hz / 3 g closed position / 2 g open position			

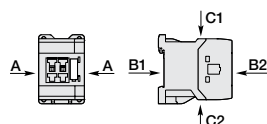

General technical data

AS/L09...AS/L16, 3-pole, screw terminated

Coil & mounting characteristics

Magnet system characteristics for AS09 ... AS16 contactors

Contactor types	AC operated	AS09	AS12	AS16	
Coil operating limits	AC supply	0.85...1.1 x U _c (at $\theta \leq 60$ °C); U _c (at $\theta \leq 70$ °C)			
acc. to IEC 60947-4-1					
AC control voltage	Rated control circuit voltage U _c	at 50 Hz 24...415 V			
		at 60 Hz 24...415 V			
Coil consumption	Average pull-in value	50 Hz	33 VA		
		60 Hz	33 VA		
		50/60 Hz	33 VA		
		Average holding value	50 Hz	6.5 VA / 1.5 W	
			60 Hz	5 VA / 1.2 W	
	50/60 Hz	6.5 VA / 1.5 W			
Drop-out voltage		Approx. 30...50 % of U _c			
Operating time					
Between coil energization and:	N.O. contact closing	9...24 ms			
	N.C. contact opening	6...18 ms			
Between coil de-energization and:	N.O. contact opening (1)	5...19 ms			
	N.C. contact closing (1)	7...22 ms			
(1) The use of RC5-1 surge suppressor increases opening time by a factor of 2 to 3					

Magnet system characteristics for ASL09 ... ASL16 contactors

Contactor types	DC operated	ASL09	ASL12	ASL16
Coil operating limits	DC supply	0.85...1.1 x U _c (at $\theta \leq 60$ °C); U _c (at $\theta \leq 70$ °C)		
acc. to IEC 60947-4-1				
DC control voltage	Rated control circuit voltage U _c	12...240 V DC		
Coil consumption	Average pull-in value	3 W		
	Average holding value	3 W		
Drop-out voltage		Approx. 10...40 % of U _c		
Coil time constant	Open	L/R	12 ms	
	Closed	L/R	40 ms	
Operating time				
Between coil energization and:	N.O. contact closing	36...59 ms		
	N.C. contact opening	31...53 ms		
Between coil de-energization and:	N.O. contact opening (1)	13...17 ms		
	N.C. contact closing (1)	15...20 ms		
(1) The use of RT5 surge suppressor increases opening time by a factor of 1.1 to 1.2				

Mounting characteristics and conditions for use

















Contactor types	AC operated	AS09	AS12	AS16
	DC operated	ASL09	ASL12	ASL16
Mounting positions				
Mounting distances		The contactors can be assembled side by side.		
Fixing	On rail according to IEC 60715, EN 60715	35 x 7.5 mm or 35 x 15 mm		
	By screws (not supplied)	2 x M4 screws placed diagonally		

General technical data

ASL09 ... ASL16 3-pole, screw terminated

Terminal characteristics

Connecting characteristics

Contactor types	AC operated	AS09	AS12	AS16
	DC operated	ASL09	ASL12	ASL16
Main terminals	 Screw terminals with cable clamp			
Connection capacity (min. ... max.)				
Main conductors (poles)				
	Rigid solid	1 x	0.75...4 mm ²	
	Flexible with non insulated ferrule	2 x	0.75...4 mm ²	
		1 x	0.75...2.5 mm ²	
	Flexible with insulated ferrule	2 x	0.75...2.5 mm ²	
		1 x	0.75...2.5 mm ²	
	Flexible with insulated ferrule	2 x	0.75...1.5 mm ²	
		1 x	0.75...1.5 mm ²	
	Bars or lugs	L ≤	7.7 mm	
		L >	3.2 mm	
Connection capacity acc. to UL / CSA (Sol/Str)		1 or 2 x	AWG 18...12	
Stripping length			9 mm	
Tightening torque		Recommended	1.00 Nm / 9 lb.in	
		Max.	1.20 Nm	
Auxiliary conductors				
(built-in auxiliary terminals + coil terminals)				
	Rigid solid	1 x	0.75...2.5 mm ²	
		2 x	0.75...2.5 mm ²	
	Flexible with non insulated ferrule	1 x	0.75...2.5 mm ²	
		2 x	0.75...2.5 mm ²	
	Flexible with insulated ferrule	1 x	0.75...2.5 mm ²	
		2 x	0.75...1.5 mm ²	
	Lugs	L ≤	7.7 mm	
		L >	3.2 mm	
Connection capacity acc. to UL / CSA (Sol/Str)		1 or 2 x	AWG 18...14	
Stripping length				
Tightening torque		Coil terminals	Recommended	1.00 Nm / 9 lb.in
			Max.	1.20 Nm
Built-in auxiliary terminals		Recommended	1.00 Nm / 9 lb.in	
		Max.	1.20 Nm	
Degree of protection				
acc. to IEC 60947-1 / EN 60947-1 and IEC 60529 / EN 60529				
All terminals			IP20	
Screw terminals				
All terminals			Delivered in open position, screws of unused terminals must be tightened	
			M3	
		Screwdriver type	Flat Ø 5.5 / Pozidriv 2	

General technical data

ASL09 ... ASL16, 3-pole, screw terminated

Built-in auxiliary contacts

Built-in auxiliary contacts according to IEC

Contactor types	AC operated	AS09	AS12	AS16
	DC operated	ASL09	ASL12	ASL16
Rated operational voltage U _e max.		690 V		
Rated frequency (without derating)		50 / 60 Hz		
Conventional free-air thermal current I _{th} - 0 ≤ 40 °C		10 A		
le / Rated operational current AC-15				
acc. to IEC 60947-5-1	24-127 V 50/60 Hz	6 A		
	220-240 V 50/60 Hz	4 A		
	400-440 V 50/60 Hz	3 A		
	500 V 50/60 Hz	2 A		
	690 V 50/60 Hz	2 A		
Making capacity AC-15		10 x I _e AC-15 acc. to IEC 60947-5-1		
Breaking capacity AC-15		10 x I _e AC-15 acc. to IEC 60947-5-1		
le / Rated operational current DC-13				
acc. to IEC 60947-5-1	24 V DC	6 A / 144 W		
	48 V DC	2.8 A / 134 W		
	72 V DC	1 A / 72 W		
	110 V DC	0.55 A / 60 W		
	125 V DC	0.55 A / 69 W		
	220 V DC	0.27 A / 60 W		
	250 V DC	0.27 A / 68 W		
Short-circuit protection device gG type fuse		10 A		
Rated short-time withstand current I _{cw}	for 1.0 s	100 A		
	for 0.1 s	140 A		
Minimum switching capacity		12 V / 3 mA		
with failure rate acc. to IEC 60947-5-4		10 ⁷		
Non-overlapping time between N.O. and N.C. contacts		1.5 ms		
Power dissipation per pole at 6 A		0.1 W		
Max. electrical switching frequency	AC-15	1200 cycles/h		
	DC-13	900 cycles/h		
Mechanically linked contacts		Built-in N.O. or N.C. auxiliary contacts and additional N.O. or N.C. auxiliary contacts (CA3 aux. contact blocks) are mechanically linked contacts.		
acc. to annex L of IEC 60947-5-1				
Mirror contacts		Built-in N.C. auxiliary contacts or additional N.C. auxiliary contacts (CA3 aux. contact blocks) are mirror contacts.		
acc. to annex F of IEC 60947-4-1				

Built-in auxiliary contacts according to UL / CSA

Contactor types	AC operated	AS09	AS12	AS16
	DC operated	ASL09	ASL12	ASL16
Max. operational voltage		600 V AC, 250 V DC		
Pilot duty		A600, Q300		
AC thermal rated current		10 A		
AC maximum volt-ampere making		7200 VA		
AC maximum volt-ampere breaking		720 VA		
DC thermal rated current		2.5 A		
DC maximum volt-ampere making-breaking		69 VA		

IEC Technical data

AS/L09...AS/L16, 3-pole, spring terminated

Utilization characteristics

Main pole - Utilization characteristics according to IEC

Contactor types	AC operated	AS09..S	AS12..S	AS16..S
	DC operated	ASL09..S	ASL12..S	ASL16..S
Standards	IEC 60947-1 / 60947-4-1 and EN 60947-1 / 60947-4-1			
Rated operational voltage U_e max.	690 V			
Rated frequency (without derating)	50 / 60 Hz			
Conventional free-air thermal current I_{th}				
acc. to IEC 60947-4-1, open contactors, $\theta \leq 40\text{ }^\circ\text{C}$	20 A	22 A	22 A	22 A
With conductor cross-sectional area	2.5 mm ²	2.5 mm ²	2.5 mm ²	2.5 mm ²
AC-1 Utilization category				
For air temperature close to contactor				
I_e / Rated operational current AC-1				
U _e max. $\leq 690\text{ V}$, 50/60 Hz	$\theta \leq 40\text{ }^\circ\text{C}$ 20 A	22 A	22 A	22 A
	$\theta \leq 60\text{ }^\circ\text{C}$ 15 A	17 A	17 A	17 A
	$\theta \leq 70\text{ }^\circ\text{C}$ 12 A	14 A	14 A	14 A
With conductor cross-sectional area	2.5 mm ²			
AC-3 Utilization category				
For air temperature close to contactor $\theta \leq 60\text{ }^\circ\text{C}$				
I_e / Max. rated operational current AC-3 (1)				
	220-230-240 V 9 A	12 A	15.7 A	
	400 V 9 A	12 A	15.5 A	
	415 V 9 A	12 A	15.5 A	
	440 V 8 A	11 A	13.6 A	
	500 V 8 A	11 A	12.5 A	
	690 V 5 A	7 A	9 A	
Rated operational power AC-3 (1)				
	220-230-240 V 2.2 kW	3 kW	4 kW	
	400 V 4 kW	5.5 kW	7.5 kW	
	415 V 4 kW	5.5 kW	7.5 kW	
	440 V 4 kW	5.5 kW	7.5 kW	
	500 V 4 kW	5.5 kW	7.5 kW	
	690 V 4 kW	5.5 kW	7.5 kW	
Rated making capacity AC-3	10 x I _e AC-3 acc. to IEC 60947-4-1			
Rated breaking capacity AC-3	8 x I _e AC-3 acc. to IEC 60947-4-1			
AC-8a Utilization category				
(without thermal overload relay - U _e 400 V 50/60 Hz - $\theta \leq 40\text{ }^\circ\text{C}$)				
I_e / Rated operational current AC-8a	12 A	16 A	22 A	
Rated operational power AC-8a	5.5 kW	7.5 kW	11 kW	
Short-circuit protection device for contactors				
without thermal overload relay - Motor protection excluded (2)				
U _e $\leq 500\text{ V AC}$ - gG type fuse	25 A			
Rated short-time withstand current I_{cw}				
at 40 °C ambient temperature,	1 s 230 A	250 A	250 A	
in free air from a cold state	10 s 100 A	124 A	124 A	
	30 s 65 A	75 A	75 A	
	1 min 50 A	55 A	55 A	
	15 min 20 A	22 A	22 A	
Maximum breaking capacity				
cos $\phi = 0.45$	at 440 V 155 A			
	at 690 V 90 A			
Power dissipation per pole				
I _e / AC-1	0.9 W	1.1 W	1.1 W	
I _e / AC-3	0.18 W	0.33 W	0.55 W	
Max. electrical switching frequency				
AC-1	600 cycles/h			
AC-3	1200 cycles/h			
AC-4	300 cycles/h			

(1) For the corresponding kW/A or hp/A values of 1500 r.p.m. 50 Hz or 1800 r.p.m. 60 Hz, 3-phase motors, see "Motor rated operational powers and currents".

(2) For the protection of motor starters against short circuits, see "Coordination with short-circuit protection devices".

UL/CSA Technical data

AS/L09...AS/L16, 3-pole, spring terminated

Utilization characteristics

Main pole - Utilization characteristics according to UL /CSA

Contactor types	AC operated	AS09..S	AS12..S	AS16..S
	DC operated	ASL09..S	ASL12..S	ASL16..S
Standards	UL 508, CSA C22.2 N°14			
Max. operational voltage	690 V			
UL / CSA General use rating				
600 V AC		12 A	12 A	15.2 A
With conductor cross-sectional area		AWG 14	AWG 14	AWG 12
UL / CSA maximum 1-phase motor rating				
Full load current	120 V AC	7.2 A	9.8 A	13.8 A
	240 V AC	8 A	10 A	12 A
Horse power rating	120 V AC	1/3 hp	1/2 hp	3/4 hp
	240 V AC	1 hp	1-1/2 hp	2 hp
UL / CSA maximum 3-phase motor rating				
Full load current (1)	200-208 V AC	7.8 A	7.8 A	11 A
	220-240 V AC	6.8 A	9.6 A	15.2 A
	440-480 V AC	7.6 A	11 A	14 A
	550-600 V AC	9 A	11 A	11 A
Horse power rating (1)	200-208 V AC	2 hp	2 hp	3 hp
	220-240 V AC	2 hp	3 hp	5 hp
	440-480 V AC	5 hp	7-1/2 hp	10 hp
	550-600 V AC	7-1/2 hp	10 hp	10 hp
Max. electrical switching frequency				
For general use	600 cycles/h			
For motor use	1200 cycles/h			

(1) For the corresponding kW/A or hp/A values of 1500 r.p.m, 50 Hz or 1800 r.p.m, 60 Hz, 3-phase motors, see "Motor rated operational powers and currents".

General technical data

Contactor types	AC operated	AS09..S	AS12..S	AS16..S
	DC operated	ASL09..S	ASL12..S	ASL16..S
Rated insulation voltage Ui				
acc. to IEC 60947-4-1	690 V			
acc. to UL / CSA	600 V			
Rated impulse withstand voltage Uimp.	6 kV			
Ambient air temperature close to contactor				
Operation	-40...+70 °C			
Storage	-60...+80 °C			
Climatic withstand	Category B according to IEC 60947-1 Annex Q			
Maximum operating altitude (without derating)	3000 m			
Mechanical durability				
Number of operating cycles	10 millions operating cycles			
Max. switching frequency	3600 cycles/h			
Shock withstand	1/2 sinusoidal shock for 11 ms: no change in contact position, closed or open position			
acc. to IEC 60068-2-27 and EN 60068-2-27				
Mounting position 1	Shock direction	AS contactors - AC operated		ASL contactors - DC operated
	A	20 g		20 g closed position / 10 g open position
	B1	10 g closed position / 5 g open position		15 g closed position / 5 g open position
	B2	15 g		10 g
	C1	20 g closed position / 9 g open position		15 g closed position / 8 g open position
	C2	20 g closed position / 14 g open position		14 g closed position / 8 g open position
Vibration withstand acc. to IEC 60068-2-6	5...300 Hz / 3 g closed position / 2 g open position			

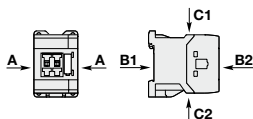

General technical data

AS/L09...AS/L16, 3-pole, spring terminated

Coil & mounting characteristics

Magnet system characteristics for AS09..S ... AS16..S contactors

Contactor types	AC operated	AS09..S	AS12..S	AS16..S	
Coil operating limits	AC supply	0.85...1.1 x U _c (at $\theta \leq 60\text{ °C}$); U _c (at $\theta \leq 70\text{ °C}$)			
acc. to IEC 60947-4-1					
AC control voltage	Rated control circuit voltage U _c	at 50 Hz	24...415 V		
		at 60 Hz	24...415 V		
Coil consumption	Average pull-in value	50 Hz	33 VA		
		60 Hz	33 VA		
		50/60 Hz	33 VA		
		Average holding value	50 Hz	6.5 VA / 1.5 W	
			60 Hz	5 VA / 1.2 W	
			50/60 Hz	6.5 VA / 1.5 W	
Drop-out voltage		Approx. 30...50 % of U _c			
Operating time					
Between coil energization and:	N.O. contact closing	9...24 ms			
	N.C. contact opening	6...18 ms			
Between coil de-energization and:	N.O. contact opening (1)	5...19 ms			
	N.C. contact closing (1)	7...22 ms			
		(1) The use of RC5-1 surge suppressor increases opening time by a factor of 2 to 3.			

Magnet system characteristics for ASL09..S ... ASL16..S contactors

Contactor types	DC operated	ASL09..S	ASL12..S	ASL16..S
Coil operating limits	DC supply	0.85...1.1 x U _c (at $\theta \leq 60\text{ °C}$); U _c (at $\theta \leq 70\text{ °C}$)		
acc. to IEC 60947-4-1				
DC control voltage	Rated control circuit voltage U _c	12...240 V DC		
		Coil consumption	Average pull-in value	
		3 W		
		Average holding value		
		3 W		
Drop-out voltage		Approx. 10...40 % of U _c		
Coil time constant	Open	L/R	12 ms	
	Closed	L/R	40 ms	
Operating time				
Between coil energization and:	N.O. contact closing	36...59 ms		
	N.C. contact opening	31...53 ms		
Between coil de-energization and:	N.O. contact opening (1)	13...17 ms		
	N.C. contact closing (1)	15...20 ms		
		(1) The use of RT5 surge suppressor increases opening time by a factor of 1.1 to 1.2		

Mounting characteristics and conditions for use













Contactor types	AC operated	AS09..S	AS12..S	AS16..S
	DC operated	ASL09..S	ASL12..S	ASL16..S
Mounting positions				
Mounting distances	The contactors can be assembled side by side.			
Fixing	On rail according to IEC 60715, EN 60715	35 x 7.5 mm or 35 x 15 mm		
	By screws (not supplied)	2 x M4 screws placed diagonally		

General technical data

AS/L09...AS/L16, 3-pole, spring terminated

Terminal characteristics

Connecting characteristics

Contactor types	AC operated	AS09..S	AS12..S	AS16..S
	DC operated	ASL09..S	ASL12..S	ASL16..S
Main terminals				
	Spring terminals			
Connection capacity (min. ... max.)				
Main conductors (poles)				
 Rigid	1 x	0.75...2.5 mm ²		
 Rigid	2 x	0.75...2.5 mm ²		
 Flexible with non insulated ferrule	1 x	0.75...2.5 mm ²		
 Flexible with non insulated ferrule	2 x	0.75...2.5 mm ²		
 Flexible with insulated ferrule	1 x	0.75...1.5 mm ²		
 Flexible with insulated ferrule	2 x	0.75...1.5 mm ²		
Connection capacity acc. to UL / CSA (Sol/Str)	1 or 2 x	AWG 18...12		
Stripping length	10 mm			
Auxiliary conductors (built-in auxiliary terminals + coil terminals)				
 Rigid solid	1 x	0.75...2.5 mm ²		
 Rigid solid	2 x	0.75...2.5 mm ²		
 Flexible with non insulated ferrule	1 x	0.75...2.5 mm ²		
 Flexible with non insulated ferrule	2 x	0.75...2.5 mm ²		
 Flexible with insulated ferrule	1 x	0.75...1.5 mm ²		
 Flexible with insulated ferrule	2 x	0.75...1.5 mm ²		
Connection capacity acc. to UL / CSA (Sol/Str)	1 or 2 x	AWG 18...14		
Stripping length	10 mm			
Degree of protection acc. to IEC 60947-1 / EN 60947-1 and IEC 60529 / EN 60529				
All terminals	IP20			
Screwdriver type	Flat Ø 3.5			

General technical data

AS/L09...AS/L16, 3-pole, spring terminated

Built-in auxiliary contacts

Built-in auxiliary contacts according to IEC

Contactor types	AC operated	AS09..S	AS12..S	AS16..S
	DC operated	ASL09..S	ASL12..S	ASL16..S
Rated operational voltage Ue max.		690 V		
Rated frequency (without derating)		50 / 60 Hz		
Conventional free air thermal current Ith - 0 ≤ 40 °C		10 A		
le / Rated operational current AC-15 acc. to IEC 60947-5-1	24-127 V 50/60 Hz	6 A		
	220-240 V 50/60 Hz	4 A		
	400-440 V 50/60 Hz	3 A		
	500 V 50/60 Hz	2 A		
	690 V 50/60 Hz	2 A		
Making capacity AC-15		10 x le AC-15 acc. to IEC 60947-5-1		
Breaking capacity AC-15		10 x le AC-15 acc. to IEC 60947-5-1		
le / Rated operational current DC-13 acc. to IEC 60947-5-1	24 V DC	6 A / 144 W		
	48 V DC	2.8 A / 134 W		
	72 V DC	1 A / 72 W		
	110 V DC	0.55 A / 60 W		
	125 V DC	0.55 A / 69 W		
	220 V DC	0.27 A / 60 W		
	250 V DC	0.27 A / 68 W		
Short-circuit protection device gG type fuse		10 A		
Rated short-time withstand current Icw	for 1.0 s	100 A		
	for 0.1 s	140 A		
Minimum switching capacity with failure rate acc. to IEC 60947-5-4		12 V / 3 m		
Non-overlapping time between N.O. and N.C. contacts		1.5 ms		
Power dissipation per pole at 6 A		0.1 W		
Max. electrical switching frequency	AC-15	1200 cycles/h		
	DC-13	900 cycles/h		
Mechanically linked contacts acc. to annex L of IEC 60947-5-1		Built-in N.O. or N.C. auxiliary contacts and additional N.O. or N.C. auxiliary contacts (CA3 aux. contact blocks) are mechanically linked contacts.		
Mirror contacts acc. to annex F of IEC 60947-4-1		Built-in N.C. auxiliary contacts or additional N.C. auxiliary contacts (CA3 aux. contact blocks) are mirror contacts.		

Built-in auxiliary contacts according to UL / CSA

Contactor types	AC operated	AS09..S	AS12..S	AS16..S
	DC operated	ASL09..S	ASL12..S	ASL16..S
Max. operational voltage		600 V AC, 250 V DC		
Pilot duty		A600, Q300		
AC thermal rated current		10 A		
AC maximum volt-ampere making		7200 VA		
AC maximum volt-ampere breaking		720 VA		
DC thermal rated current		2.5 A		
DC maximum volt-ampere making-breaking		69 VA		

IEC Technical data

VASL09 ... VASL16, 3-pole, reversing

Utilization characteristics

Main pole - Utilization characteristics according to IEC

Contactor types	AC operated	VAS09	VAS12	VAS16
	DC operated	VASL09	VASL12	VASL16
Standards	IEC 60947-1 / 60947-4-1 and EN 60947-1 / 60947-4-1			
Rated operational voltage U_e max.	690 V			
Rated frequency (without derating)	50 / 60 Hz			
Conventional free-air thermal current I_{th}				
acc. to IEC 60947-4-1, open contactors, $\theta \leq 40$ °C		22 A	25 A	25 A
With conductor cross-sectional area		2.5 mm ²	4 mm ²	4 mm ²
AC-3 Utilization category				
For air temperature close to contactor $\theta \leq 60$ °C				
I_e / Max. rated operational current AC-3 (1)				
	220-230-240 V	9 A	12 A	15.7 A
	400 V	9 A	12 A	15.5 A
	415 V	9 A	12 A	15.5 A
	440 V	8 A	11 A	13.6 A
	500 V	8 A	11 A	12.5 A
	690 V	5 A	7 A	9 A
Rated operational power AC-3 (1)				
	220-230-240 V	2.2 kW	3 kW	4 kW
	400 V	4 kW	5.5 kW	7.5 kW
	415 V	4 kW	5.5 kW	7.5 kW
	440 V	4 kW	5.5 kW	7.5 kW
	500 V	4 kW	5.5 kW	7.5 kW
	690 V	4 kW	5.5 kW	7.5 kW
Rated making capacity AC-3	10 x I _e AC-3 acc. to IEC 60947-4-1			
Rated breaking capacity AC-3	8 x I _e AC-3 acc. to IEC 60947-4-1			
Short-circuit protection device for contactors	without thermal overload relay - Motor protection excluded (2)			
U _e ≤ 500 V AC - gG type fuse		25 A		
Rated short-time withstand current I_{cw}				
at 40 °C ambient temperature,	1 s	230 A	250 A	250 A
in free air from a cold state	10 s	100 A	124 A	124 A
	30 s	65 A	75 A	75 A
	1 min	50 A	55 A	55 A
	15 min	22 A	24 A	24 A
Maximum breaking capacity				
cos φ = 0.45	at 440 V	155 A		
	at 690 V	90 A		
Power dissipation per pole				
	I_e / AC-3	0.16 W	0.3 W	0.5 W
Max. electrical switching frequency	AC-3	600 cycles/h		



3-phase motors



1500 r.p.m. 50 Hz
1800 r.p.m. 60 Hz
3-phase motors

(1) For the corresponding kW/A or hp/A values of 1500 r.p.m, 50 Hz or 1800 r.p.m, 60 Hz, 3-phase motors, see "Motor rated operational powers and currents".

(2) For the protection of motor starters against short circuits, see "Coordination with short-circuit protection devices".

UL/CSA Technical data

VAS/L09 ... VAS/L16, 3-pole, reversing

Utilization characteristics

Main pole - Utilization characteristics according to UL / CSA

Contactor types	AC operated	VAS09	VAS12	VAS16
	DC operated	VASL09	VASL12	VASL16
Standards	UL 508, CSA C22.2 N°14			
Max. operational voltage	690 V			
UL / CSA maximum 1-phase motor rating				
Full load current	120 V AC	7.2 A	9.8 A	13.8 A
	240 V AC	8 A	10 A	12 A
Horse power rating	120 V AC	1/3 hp	1/2 hp	3/4 hp
	240 V AC	1 hp	1-1/2 hp	2 hp
UL / CSA maximum 3-phase motor rating				
Full load current (1)	200-208 V AC	7.8 A	7.8 A	11 A
	220-240 V AC	6.8 A	9.6 A	15.2 A
	440-480 V AC	7.6 A	11 A	14 A
	550-600 V AC	9 A	11 A	11 A
Horse power rating (1)	200-208 V AC	2 hp	2 hp	3 hp
	220-240 V AC	2 hp	3 hp	5 hp
	440-480 V AC	5 hp	7-1/2 hp	10 hp
	550-600 V AC	7-1/2 hp	10 hp	10 hp
Max. electrical switching frequency	600 cycles/h			
For motor use	600 cycles/h			

(1) For the corresponding kW/A or hp/A values of 1500 r.p.m., 50 Hz or 1800 r.p.m., 60 Hz, 3-phase motors, see "Motor rated operational powers and currents".

General technical data

Contactor types	AC operated	VAS09	VAS12	VAS16
	DC operated	VASL09	VASL12	VASL16
Rated insulation voltage Ui				
acc. to IEC 60947-4-1	690 V			
acc. to UL / CSA	600 V			
Rated impulse withstand voltage Uimp.	6 kV			
Ambient air temperature close to contactor				
Operation	Fitted with thermal overload relay	-25...+60 °C		
	Without thermal overload relay	-40...+70 °C		
Storage	-60...+80 °C			
Climatic withstand	Category B according to IEC 60947-1 Annex Q			
Maximum operating altitude (without derating)	3000 m			
Mechanical durability				
Number of operating cycles	5 millions operating cycles			
Max. switching frequency	1800 cycles/h			

General technical data

VAS/L09 ... VAS/L16, 3-pole, reversing

Coil & mounting characteristics

Magnet system characteristics for VAS09 ... VAS16 contactors

Contactor types	AC operated	VAS09	VAS12	VAS16
Coil operating limits	AC supply	0.85...1.1 x U _c (at $\theta \leq 60$ °C); U _c (at $\theta \leq 70$ °C)		
acc. to IEC 60947-4-1				
AC control voltage	Rated control circuit voltage U _c	at 50 Hz	24...415 V	
		at 60 Hz	24...415 V	
Coil consumption	Average pull-in value	50 Hz	33 VA	
		60 Hz	33 VA	
		50/60 Hz	33 VA	
	Average holding value	50 Hz	6.5 VA / 1.5 W	
		60 Hz	5 VA / 1.2 W	
		50/60 Hz	6.5 VA / 1.5 W	
Drop-out voltage		Approx. 30...50 % of U _c		
Operating time				
Between coil energization and:	N.O. contact closing	9...24 ms		
	N.C. contact opening	6...18 ms		
Between coil de-energization and:	N.O. contact opening (1)	5...19 ms		
	N.C. contact closing (1)	7...22 ms		
		(1) The use of RC5-1 surge suppressor increases opening time by a factor of 2 to 3.		

Magnet system characteristics for VASL09 ... VASL16 contactors

Contactor types	DC operated	VASL09	VASL12	VASL16	
Coil operating limits	DC supply	0.85...1.1 x U _c (at $\theta \leq 60$ °C); U _c (at $\theta \leq 70$ °C)			
acc. to IEC 60947-4-1					
DC control voltage	Rated control circuit voltage U _c	12...240 V DC			
		Coil consumption	Average pull-in value		3 W
		Average holding value		3 W	
Drop-out voltage		Approx. 10...40 % of U _c			
Coil time constant	Open	L/R	12 ms		
	Closed	L/R	40 ms		
Operating time					
Between coil energization and:	N.O. contact closing	36...59 ms			
	N.C. contact opening	31...53 ms			
Between coil de-energization and:	N.O. contact opening (1)	13...17 ms			
	N.C. contact closing (1)	15...20 ms			
		(1) The use of RT5 surge suppressor increases opening time by a factor of 1.1 to 1.2			

Mounting characteristics and conditions for use







Contactor types	AC operated	VAS09	VAS12	VAS16
	DC operated	VASL09	VASL12	VASL16
Mounting positions				
Mounting distances	The reversing contactors can be assembled side by side.			
Fixing	On rail according to IEC 60715, EN 60715	35 x 7.5 mm or 35 x 15 mm		
	By screws (not supplied)	2 x M4 screws placed diagonally		

General technical data

VAS/L09 ... VAS/L16, 3-pole, reversing

Terminal characteristics

Connecting characteristics



Contactor types	AC operated	VAS09	VAS12	VAS16
	DC operated	VASL09	VASL12	VASL16
Main terminals				
 <p>Screw terminals with cable clamp</p>				
Connection capacity (min. ... max.)				
Main conductors (poles)				
	Rigid solid	1 x	0.75...4 mm ²	
	Flexible with non insulated ferrule	1 x	0.75...2.5 mm ²	
	Flexible with insulated ferrule	1 x	0.75...1.5 mm ²	
Connection capacity acc. to UL / CSA (Sol/Str)		1 x	AWG 18...12	
Stripping length			9 mm	
Tightening torque		Recommended	1.00 Nm / 9 lb.in	
		Max.	1.20 Nm	
Auxiliary conductors (built-in auxiliary terminals + coil terminals)				
	Rigid solid	1 x	0.75...2.5 mm ²	
	Flexible with non insulated ferrule	1 x	0.75...2.5 mm ²	
	Flexible with insulated ferrule	1 x	0.75...1.5 mm ²	
Connection capacity acc. to UL / CSA (Sol/Str)		1 x	AWG 18...14	
Stripping length			9 mm	
Tightening torque				
Coil terminals		Recommended	1.00 Nm / 9 lb.in	
		Max.	1.20 Nm	
Built-in auxiliary terminals		Recommended	1.00 Nm / 9 lb.in	
		Max.	1.20 Nm	
Degree of protection				
acc. to IEC 60947-1 / EN 60947-1 and IEC 60529 / EN 60529				
All terminals			IP20	
Screw terminals				
All terminals			Delivered in open position, screws of unused terminals must be tightened	
			M3	
		Screwdriver type	Flat Ø 5.5 / Pozidriv 2	

IEC Technical data

(V)B/C6...(V)B/C7, 3 & 4-pole

Utilization characteristics

Main pole – Utilization characteristics according to IEC

Contactor types	AC operated	B6, VB6, VB6A	B7, VB7, VB7A
	DC operated	BC6, VBC6, VBC6A	BC7, TBC7, VBC7, VBC7A
Standards	IEC 60947-1 / 60947-4-1 and EN 60947-1 / 60947-4-1		
Rated operational voltage U_e	690 V AC		
Rated frequency (without derating)	DC or 50 / 60 Hz		
Conventional free-air thermal current I_{th} acc. to IEC 60947-4-1, open contactors, $\theta \leq 40^\circ\text{C}$, with conductor cross-sectional area	20 A		
AC-1 Utilization category for air temperature close to contactor $\theta \leq 40^\circ\text{C}$			
I_e / Rated operational current AC-1	220-230-240 V	Screw terminal types: 20 A Soldering pin types: 12 A Flat pin types: 16 A	
$U_{e\max} \leq 690\text{ V}, 50/60\text{ Hz}$	380-400 V	Screw terminal types: 20 A Soldering pin types: 12 A Flat pin types: 16 A	
	440 V	Screw terminal types: 20 A Soldering pin types: 12 A Flat pin types: 16 A	
	500 V	12 A	
	690 V	6 A	
AC-1 Utilization category for air temperature close to contactor $\theta \leq 55^\circ\text{C}$			
I_e / Rated operational current AC-1	220-230-240 V	Screw terminal types: 16 A Soldering pin types: 12 A Flat pin types: 16 A	Screw terminal types: 20 A Soldering pin types: 12 A Flat pin types: 16 A
$U_{e\max} \leq 690\text{ V}, 50/60\text{ Hz}$	380-400 V	Screw terminal types: 16 A Soldering pin types: 12 A Flat pin types: 16 A	Screw terminal types: 20 A Soldering pin types: 12 A Flat pin types: 16 A
	440 V	Screw terminal types: 16 A Soldering pin types: 12 A Flat pin types: 16 A	Screw terminal types: 20 A Soldering pin types: 12 A Flat pin types: 16 A
	500 V	12 A	
	690 V	6 A	
AC-3 Utilization category for air temperature close to contactor $\theta \leq 55^\circ\text{C}$			
I_e / Rated operational current AC-3	220-230-240 V	9 A	12 A
	380-400 V	8 A	12 A
	440 V	8 A	12 A
	500 V	6.5 A	9 A
	690 V	3.5 A	3.5 A
Rated operational power AC-3	220-230-240 V	2.2 kW	3 kW
	380-400 V	4 kW	5.5 kW
	440 V	4 kW	5.5 kW
	500 V	3 kW	4 kW
	690 V	3 kW	3 kW
DC-1 Utilization category for air temperature close to contactor $\theta \leq 55^\circ\text{C}$			
I_e / Rated operational current DC-1	110 V	-	4 A
	220 V	-	0.6 A
DC-3 Utilization category for air temperature close to contactor $\theta \leq 55^\circ\text{C}$			
I_e / Rated operational current DC-3	110 V	-	1.5 A
	220 V	-	0.25 A
DC-5 Utilization category for air temperature close to contactor $\theta \leq 55^\circ\text{C}$			
I_e / Rated operational current DC-5	110 V	-	0.4 A
	220 V	-	0.2 A
Rated making capacity AC-3	$10 \times I_e$ AC-3 acc. to IEC 60947-4-1		
Rated breaking capacity AC-3	$8 \times I_e$ AC-3 acc. to IEC 60947-4-1		
Short-circuit protection device for contactors without thermal O/L relay - motor protection excluded $U_e \leq 500\text{ V AC}$ - gG type fuse	Coordination type 1: 25 A / Coordination type 2: 20 A		
Rated short-time withstand current I_{cw} at 40°C ambient temperature, in free air from a cold state	10 s	64 A	96 A
Maximum breaking capacity $\cos \phi = 0.45$	at 400 V	64 A	96 A
Maximum electrical switching frequency	AC-1	300 cycles/h	
	AC-3	600 cycles/h	
	DC-1, DC-3, DC-5	600 cycles/h	

UL/CSA Technical data

(M)B/C6...(M)B/C7, 3 & 4-pole

Utilization characteristics

Main pole – Utilization characteristics according to UL/CSA

Contactor types	AC operated	B6, VB6, VB6A	B7, VB7, VB7A
	DC operated	BC6, VBC6, VBC6A	BC7, TBC7, VBC7, VBC7A
Standards	UL 508, CSA C22.2 N° 14		
Maximum operational voltage	600 V		
UL/CSA general use rating	12 A		16 A
UL/CSA maximum 1-phase motor rating			
Full load current	120 V AC	8.4 A	13.8 A
	240 V AC	6.8 A	10.0 A
Horse power rating	120 V AC	1 hp (screw termination only)	0.75 hp
	240 V AC	2 hp (screw termination only)	1.5 hp
UL/CSA maximum 3-phase motor rating			
Full load current ¹⁾	200-208 V AC	4.6 A	7.5 A
	220-240 V AC	6.8 A	9.6 A
	440-480 V AC	3.4 A	7.6 A
	550-600 V AC	1.7 A	6.1 A
Horse power rating ¹⁾	200-208 V AC	1 hp	2 hp
	220-240 V AC	2 hp	3 hp
	440-480 V AC	3 hp	5 hp
	550-600 V AC	1 hp	5 hp
Maximum electrical switching frequency			
For resistive loads AC-1	300 cycles/h		
For motor loads AC-3	600 cycles/h		

¹⁾ For the corresponding kW/A or hp/A values of 1500 r.p.m, 50 Hz or 1800 r.p.m, 60 Hz, 3-phase motors, see "Motor rated operational powers and currents".

General technical data

Contactor types	AC operated	B6, VB6, VB6A	B7, VB7, VB7A
	DC operated	BC6, VBC6, VBC6A	BC7, TBC7, VBC7, VBC7A
Rated insulation voltage U_i			
acc. to IEC 60947-4-1	690 V		
acc. to UL/CSA	600 V		
Rated impulse withstand voltage U_{imp}	6 kV		
Ambient air temperature, close to contactor			
Operation	Fitted with thermal overload relay	-25 ... +55 °C	
	Without thermal overload relay	-25 ... +55 °C	
Storage	-40 ... +80 °C		
Climatic withstand	acc. to IEC 60947-1 Annex Q		
Maximum operating altitude (without derating)	2000 m		
Mechanical durability	10 ⁷ operating cycles		
Resistance to shock	Half-sine		
acc. to IEC 60068-2-27 and EN 60068-2-27	15 g / 11 ms		
acc. to IEC/EN 60947-1 Annex. Q	Category E		
Resistance to vibrations	Sinusoidal		
acc. to IEC 60068-2-27 and EN 60068-2-27	5 g / 3 ... 150 Hz		
acc. to IEC/EN 60947-1 Annex. Q	Category E		

General technical data

(M)B/C6...(M)B/C7, 3 & 4-pole

Coil & mounting characteristics

Magnet system characteristics for B6, B7 contactors

Contactor types	AC operated	B6, VB6	B7, VB7
Coil operating limits acc. to IEC 60947-4-1	AC supply	0.85 ... 1.1 x U _c	
AC control voltage			
Rated control circuit voltage U _c		See ordering tables	
Coil consumption	Average pull-in value	3.5 VA / 3.5 W	
	Average holding value	3.5 VA / 3.5 W	
Drop-out voltage		0.20 ... 0.75 % of U _c	

Magnet system characteristics for BC6, BC7 contactors

Contactor types	DC operated	BC6, VBC6	BC7, VBC7
Coil operating limits acc. to IEC 60947-4-1	DC supply	0.85 ... 1.1 x U _c	
DC control voltage			
Rated control circuit voltage U _c		See ordering tables	
Coil consumption ¹⁾	Average pull-in value	3.5 VA / 3.5 W	
	Average holding value	3.5 VA / 3.5 W	
Drop-out voltage in % of U _{c,min}		0.10 ... 0.75 x U _c	

¹⁾ Interface mini-contactors: see coil consumption on ordering details pages

Magnet system characteristics for TBC7 contactors

Contactor types	DC operated	TBC7	
Coil operating limits acc. to IEC 60947-4-1	DC supply	Wide range voltage supply see ordering tables, U _{c,min} ... U _{c,max}	
AC control voltage			
Rated control circuit voltage U _c		See ordering tables	
Coil consumption	Average pull-in value	5 VA / 5 W	
	Average holding value	5 VA / 5 W	
Drop-out voltage in % of U _{c,min}		≤ 0.20 % of U _{c,min}	

Mounting characteristics and conditions for use

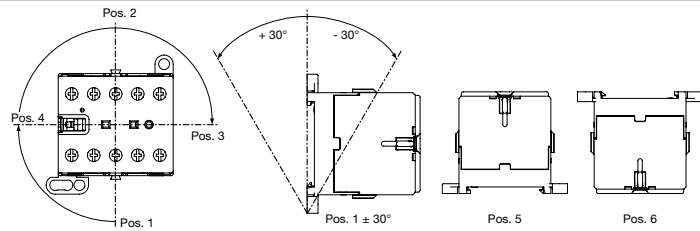
Contactor types	AC operated	B6, VB6, VB6A	B7, VB7, VB7A
	DC operated	BC6, VBC6, VBC6A	BC7, TBC7, VBC7, VBC7A
Mounting positions			
Mounting distances		The contactors can be assembled side by side	
Fixing			
On rail acc. to IEC 60715, EN 60715		35 x 7.5 mm or 35 x 15 mm	
By screws (not supplied)		2 x M4 screws placed diagonally	

General technical data

(V)B/C6...(V)B/C7, 3 & 4-pole

Built-in auxiliary contacts

Built-in auxiliary contacts according to IEC

Contactor types	AC operated	B6, VB6, VB6A	B7, VB7, VB7A
	DC operated	BC6, VBC6, VBC6A	BC7, TBC7, VBC7, VBC7A
Standards	IEC 60947-1 / 60947-4-1 and EN 60947-1 / 60947-4-1		
Rated operational voltage U _e max	690 V		
Rated frequency (without derating)	DC or 50 / 60 Hz		
Conventional free-air thermal current I _{th} 0 ≤ 40 °C	6 A		
I _e / Rated operational current AC-15 acc. to IEC 60947-5-1	24 V 50/60 Hz	4 A	
	110-120 V 50/60 Hz	4 A	
	220-230-240 V 50/60 Hz	4 A	
	380-400 V 50/60 Hz	3 A	
	440 V 50/60 Hz	3 A	
I _e / Rated operational current DC-13 acc. to IEC 60947-5-1	24 V DC	2.5 A	
	110 V DC	0.7 A	
	220 - 240 V DC	0.4 A	
Short-circuit protection device	6 A, Type gG		
Minimum switching capacity with failure rate acc. to IEC 60947-5-4	17 V / 5 mA		
Maximum electrical switching frequency	AC-15	600 cycles/h	
	DC-13	600 cycles/h	

Built-in auxiliary contacts according to UL/CSA





Contactor types	AC operated	B6, VB6, VB6A	B7, VB7, VB7A
	DC operated	BC6, VBC6, VBC6A	BC7, VBC7, VBC7A
Max. operational voltage	600 V AC		
Pilot duty	A600		
AC thermal rated current	5 A		

General technical data

(V)B/C6...(V)B/C7, 3 & 4 pole

Terminal characteristics

Connection characteristics

Contactor types	AC operated	B6, VB6, VB6A	B7, VB7, VB7A
	DC operated	BC6, VBC6, VBC6A	BC7, TBC7, VBC7, VBC7A
Main terminals ¹⁾	 Screw terminals with cable clamp		
Connection capacity			
Main conductors (poles)			
 Rigid: solid	1 or 2 x	1 ... 4 mm ²	
 Flexible without ferrule	1 or 2 x	1 ... 2.5 mm ²	
Connection capacity acc. to UL/CSA (Sol/Str)	1 or 2 x	AWG 22 ... 10	
Stripping length		9 mm	
Tightening torques		0.8 ... 1.1 Nm / 7 lb.in	
Connection capacity – auxiliary conductors (built-in auxiliary terminals + coil terminals)			
 Rigid: solid	1 or 2 x	1 ... 4 mm ²	
 Flexible without ferrule	1 or 2 x	1 ... 2.5 mm ²	
Connection capacity acc. to UL/CSA (Sol/Str)	1 or 2 x	AWG 22 ... 10	
Stripping length		9 mm	
Tightening torques			
Coil terminals		0.8 ... 1.1 Nm / 7 lb.in	
Built-in auxiliary terminals		0.8 ... 1.1 Nm / 7 lb.in	
Degree of protection acc. to IEC 60947-1 / EN 60947-1 and IEC 60529 / EN 60529			
Main terminals		IP20	
Coil terminals		IP20	
Built-in auxiliary terminals		IP20	
Screw terminals (Delivered in open position, screws of unused terminals must be tightened)			
All terminals		M3	
Screwdriver type Flat Ø 5.5 mm / Pozidriv 1			

¹⁾ Soldering pin connection acc. to DIN 40801: 0.8 x 1 mm / 0.8 x 2.54 mm
 Flat pin connection acc. to DIN 46248: 1 x 6.3 mm / 1 x 2.8 mm

IEC/UL/CSA Technical data

AF09(Z)...AF38(Z), 4-pole

Utilization characteristics

Main pole - Utilization characteristics according to IEC

Contactor types	AC / DC operated	AF09(Z)	AF16(Z)	AF26(Z)	AF38(Z)
Standards		IEC 60947-1 / 60947-4-1 and EN 60947-1 / 60947-4-1			
Rated operational voltage Ue max.		690 V			
Rated frequency (without derating)		50 / 60 Hz			
Conventional free-air thermal current Ith acc. to IEC 60947-4-1, open contactors, $\theta \leq 40^\circ\text{C}$		35 A	35 A	55 A	55 A
With conductor cross-sectional area		6 mm ²	6 mm ²	16 mm ²	16 mm ²
AC-1 Utilization category					
For air temperature close to contactor					
Ie / Rated operational current AC-1		$\theta \leq 40^\circ\text{C}$	$\theta \leq 40^\circ\text{C}$	$\theta \leq 40^\circ\text{C}$	$\theta \leq 40^\circ\text{C}$
Ue max. $\leq 690\text{ V}$, 50/60 Hz		25 A	30 A	45 A	55 A
		$\theta \leq 60^\circ\text{C}$	$\theta \leq 60^\circ\text{C}$	$\theta \leq 60^\circ\text{C}$	$\theta \leq 60^\circ\text{C}$
		25 A	30 A	40 A	45 A
		$\theta \leq 70^\circ\text{C}$	$\theta \leq 70^\circ\text{C}$	$\theta \leq 70^\circ\text{C}$	$\theta \leq 70^\circ\text{C}$
		22 A	26 A	32 A	37 A
With conductor cross-sectional area		4 mm ²	6 mm ²	10 mm ²	16 mm ²
Short-circuit protection device for contactors					
Without thermal overload relay - Motor protection excluded					
Ue $\leq 500\text{ V AC}$ - gG type fuse		25 A	32 A	50 A	63 A
Rated short-time withstand current Icw		1 s	1 s	1 s	1 s
At 40 °C ambient temperature, in free air from a cold state		300 A	300 A	450 A	450 A
		10 s	10 s	10 s	10 s
		150 A	150 A	300 A	300 A
		30 s	30 s	30 s	30 s
		80 A	80 A	225 A	225 A
		1 min	1 min	1 min	1 min
		60 A	60 A	150 A	150 A
		15 min	15 min	15 min	15 min
		35 A	35 A	55 A	55 A
Power dissipation per pole		Ie / AC-1	Ie / AC-1	Ie / AC-1	Ie / AC-1
		0.8 W	1.2 W	1.6 W	2.3 W
Max. electrical switching frequency		AC-1	AC-1	AC-1	AC-1
		600 cycles/h	600 cycles/h	600 cycles/h	600 cycles/h

Main pole - Utilization characteristics according to UL / CSA

Contactor types	AF09(Z)	AF16(Z)	AF26(Z)	AF38(Z)
Standards				
UL 508, CSA C22.2 N°14				
Max. operational voltage				
600 V				
UL / CSA general use rating				
600 V AC				
With conductor cross-sectional area				
AWG 10				
Max. electrical switching frequency				
For general use				
600 cycles/h				

Remark for 4-pole contactors fitted with 2 N.O. + 2 N.C. main poles

These contactors are suitable for controlling 2 separate circuits, i.e. 2 loads with 2 separate supplies, or 1 circuit comprising 2 separate loads with a single supply (see diagrams below). When the contactor operates there is no mechanical overlapping between the N.O. poles and the N.C. poles: BREAK before MAKE.

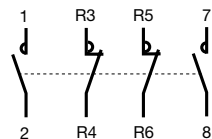

These contactors are not suitable for a reversing starter or for controlling a single load from 2 separate supplies.

Block diagrams

– Single supply and 2 separate loads

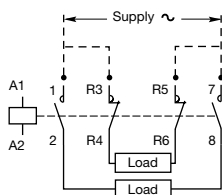

– 2 separate supplies and 2 separate loads

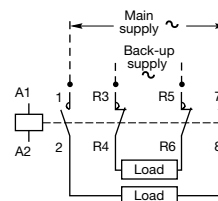

IEC/UL/CSA Technical data

A/E/F45...A/E/F75, 4-pole

Utilization characteristics

Main pole - Utilization characteristics according to IEC

Contactor types	AC operated	A45	A50	A75
	DC operated	AE45	AE50	AE75
		TAE45	TAE50	TAE75
	AC / DC operated	AF45	AF50	AF75
Standards		IEC 60947-1 / 60947-4-1 and EN 60947-1 / 60947-4-1		
Rated operational voltage U_e max.		1000 V (690 V for AF.. contactors)		
Rated frequency (without derating)		50 / 60 Hz		
Conventional free-air thermal current I_{th}				
acc. to IEC 60947-4-1, open contactors, $\theta \leq 40^\circ\text{C}$		100 A	100 A	125 A
With conductor cross-sectional area		35 mm ²	35 mm ²	50 mm ²
AC-1 Utilization category				
For air temperature close to contactor				
I_e / Rated operational current AC-1	$\theta \leq 40^\circ\text{C}$	70 A	100 A	125 A
U _e max. $\leq 690\text{ V}$, 50/60 Hz	$\theta \leq 55^\circ\text{C}$	60 A	85 A	105 A
	$\theta \leq 70^\circ\text{C}$ (1)	50 A	70 A	85 A
With conductor cross-sectional area		25 mm ²	35 mm ²	50 mm ²
Short-circuit protection device for contactors				
without thermal overload relay - Motor protection excluded				
U _e $\leq 500\text{ V AC}$ - gG type fuse		80 A	100 A	160 A
Rated short-time withstand current I_{cw}				
At 40 °C ambient temperature,	1 s	1000 A		
in free air from a cold state	10 s	650 A		
	30 s	370 A		
	1 min	250 A		
	15 min	110 A	110 A	135 A
Power dissipation per pole	I _e / AC-1	2.5 W	5 W	7 W
Max. electrical switching frequency	AC-1	600 cycles/h (300 for AF.., AE.., TAE..)		

(1) Unauthorized for TAE.. contactors

Main pole - Utilization characteristics according to UL / CSA

Contactor types	AC operated	A45	A50	A75
	DC operated	AE45	AE50	AE75
		TAE45	TAE50	TAE75
	AC / DC operated	AF45	AF50	AF75
Standards		UL 508, CSA C22.2 N°14		
Max. operational voltage		600 V		
UL / CSA general use rating				
600 V AC		65 A	80 A	105 A
With conductor cross-sectional area		AWG 6	AWG 4	AWG 2
Max. electrical switching frequency				
For general use		600 cycles/h (300 for AF.., AE.., TAE..)		

Remark for 4-pole contactors fitted with 2 N.O. + 2 N.C. main poles

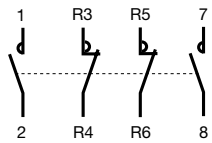

These contactors are suitable for controlling 2 separate circuits, i.e. 2 loads with 2 separate supplies, or 1 circuit comprising 2 separate loads with a single supply (see diagrams below). When the contactor operates there is no mechanical overlapping between the N.O. poles and the N.C. poles: BREAK before MAKE.



These contactors are not suitable for a reversing starter or for controlling a single load from 2 separate supplies.

Block diagrams

– Single supply and 2 separate loads

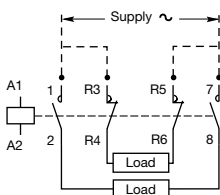

– 2 separate supplies and 2 separate loads

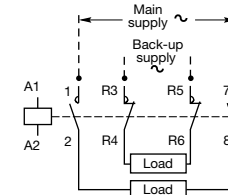

IEC/UL/CSA Technical data

EK110...EK1000, 4-pole

Utilization characteristics

Across the line
Contactors

1

Main pole - Utilization characteristics according to IEC

Contactor types	AC or DC operated	EK110	EK150	EK175	EK210	EK370	EK550	EK1000
Standards		IEC 60947-1 / 60947-4-1 and EN 60947-1 / 60947-4-1						
Rated operational voltage U_e max.		1000 V						
Rated frequency (without derating)		50 / 60 Hz						
Conventional free-air thermal current I_{th}								
acc. to IEC 60947-4-1, open contactors, $\theta \leq 40^\circ\text{C}$		200 A	250 A	300 A	350 A	550 A	800 A	1000 A
With conductor cross-sectional area		95 mm ²	150 mm ²	185 mm ²	240 mm ²	2x 185 mm ²	2x 240 mm ²	2x 300 mm ²
AC-1 Utilization category								
For air temperature close to contactor								
I_e / Rated operational current AC-1								
$\theta \leq 40^\circ\text{C}$		200 A	250 A	300 A	350 A	550 A	800 A	1000 A
$\theta \leq 55^\circ\text{C}$		180 A	230 A	270 A	310 A	470 A	650 A	800 A
$\theta \leq 70^\circ\text{C}$		155 A	200 A	215 A	250 A	400 A	575 A	720 A
With conductor cross-sectional area		95 mm ²	150 mm ²	185 mm ²	240 mm ²	2x 185 mm ²	2x 240 mm ²	2x 300 mm ²
AC-3 Utilization category								
For air temperature close to contactor $\theta \leq 55^\circ\text{C}$								
I_e / Max. rated operational current AC-3 (1)								
	220-230-240 V	120 A	145 A	210 A	210 A	400 A	550 A	-
	380-400 V	120 A	145 A	210 A	210 A	400 A	550 A	-
	415 V	120 A	145 A	210 A	210 A	400 A	550 A	-
	440 V	120 A	145 A	210 A	210 A	370 A	550 A	-
	500 V	120 A	145 A	210 A	210 A	370 A	550 A	-
	690 V	120 A	120 A	210 A	210 A	370 A	550 A	-
	1000 V	64 A	80 A	113 A	113 A	155 A	175 A	-
Rated operational power AC-3 (1)								
	220-230-240 V	30 kW	45 kW	59 kW	59 kW	110 kW	160 kW	-
	380-400 V	55 kW	75 kW	110 kW	110 kW	200 kW	280 kW	-
	415 V	55 kW	75 kW	110 kW	110 kW	220 kW	315 kW	-
	440 V	59 kW	75 kW	110 kW	110 kW	220 kW	315 kW	-
	500 V	75 kW	90 kW	132 kW	132 kW	250 kW	400 kW	-
	690 V	110 kW	110 kW	160 kW	160 kW	355 kW	500 kW	-
	1000 V	90 kW	110 kW	160 kW	160 kW	220 kW	250 A	-
Rated making capacity AC-3		10 x I_e AC-3 acc. to IEC 60947-4-1						
Rated breaking capacity AC-3		8 x I_e AC-3 acc. to IEC 60947-4-1						
Short-circuit protection device for contactors								
without thermal overload relay - Motor protection excluded								
$U_e \leq 500\text{ V AC}$ - gG type fuse		250 A	250 A	355 A	355 A	630 A	800 A	1000 A
Rated short-time withstand current I_{cw}								
1 s		1700 A	1800 A	2300 A	2300 A	5500 A	5500 A	6800 A
at 40°C ambient temperature,	10 s	900 A	1200 A	1680 A	1680 A	5300 A	5300 A	6400 A
in free air from a cold state	30 s	600 A	700 A	1000 A	1000 A	3700 A	3700 A	4400 A
	1 min	450 A	550 A	800 A	800 A	3000 A	3000 A	3400 A
	15 min	210 A	250 A	320 A	320 A	1000 A	1000 A	1200 A
Maximum breaking capacity								
$\cos \phi = 0.45$	at 440 V	1400 A	1500 A	2000 A	2000 A	5000 A	5400 A	-
($\cos \phi = 0.35$ for $I_e > 100\text{ A}$)	at 690 V	1100 A	1200 A	1700 A	1700 A	5000 A	5400 A	-
Power dissipation per pole								
	I_e / AC-1	10 W	13 W	18 W	18 W	40 W	60 W	80 W
	I_e / AC-3	3 W	5 W	9 W	9 W	15 W	25 W	-
Max. electrical switching frequency								
	AC-1	300 cycles/h						
	AC-3	300 cycles/h						
	AC-2, AC-4	150 cycles/h			120 cycles/h			



3-phase motors



1500 r.p.m. 50 Hz
1800 r.p.m. 60 Hz
3-phase motors

Main pole - Utilization characteristics according to UL / CSA

Contactor types	AC or DC operated	EK110	EK150	EK175	EK210	EK370	EK550	EK1000
Standards		UL 508, CSA C22.2 N°14						
Max. operational voltage		600 V						
UL / CSA general use rating								
600 V AC		170 A	200 A	250 A	300 A	420 A	540 A	-
Max. electrical switching frequency								
For general use		300 cycles/h						

(1) For the corresponding kW/A or hp/A values of 1500 r.p.m, 50 Hz or 1800 r.p.m, 60 Hz, 3-phase motors, see "Motor rated operational powers and currents".

General technical data

AF09(Z)...AF38(Z)

Coil & mounting characteristics

Magnet system characteristics

Contactor types	AC / DC operated	AF09(Z)	AF16(Z)	AF26(Z)	AF38(Z)
Coil operating limits acc. to IEC 60947-4-1	AC supply	At $\theta \leq 60^\circ\text{C}$ $0.85 \times U_c \text{ min...} 1.1 \times U_c \text{ max.}$ At $\theta \leq 70^\circ\text{C}$ $0.85 \times U_c \text{ min...} U_c \text{ max.}$			
	DC supply	At $\theta \leq 60^\circ\text{C}$ $0.85 \times U_c \text{ min...} 1.1 \times U_c \text{ max.}$ At $\theta \leq 70^\circ\text{C}$ (AF) $0.85 \times U_c \text{ min...} U_c \text{ max.}$ - (AF.Z) $0.85 \times U_c \text{ min...} 1.1 \times U_c \text{ max.}$			
AC control voltage 50/60 Hz	Rated control circuit voltage U_c	24...500 V AC			
	Coil consumption	Average pull-in value	(AF) 50 VA - (AF.Z) 16 VA		
		Average holding value	(AF) 2.2 VA / 2 W - (AF.Z) 1.7 VA / 1.5 W		
DC control voltage	Rated control circuit voltage U_c	12...500 V DC			
	Coil consumption	Average pull-in value	(AF) 50 W - (AF.Z) 12...16 W		
		Average holding value	(AF) 2 W - (AF.Z) 1.7 W		
PLC-output control		(AF.Z) $\geq 500 \text{ mA}$ 24 V DC			
Drop-out voltage		$\leq 60\%$ of $U_c \text{ min.}$			
Voltage sag immunity	acc. to SEMI F47-0706	(AF.Z) conditions of use on request			
Dips withstand -20 °C $\leq \theta \leq$ +60 °C		(AF.Z) 22 ms average			
Operating time	Between coil energization and:	N.O. contact closing	40...95 ms		
		N.C. contact opening	38...90 ms		
	Between coil de-energization and:	N.O. contact opening	11...95 ms		
		N.C. contact closing	13...98 ms		

Mounting characteristics and conditions for use

Contactor types	AF09(Z)	AF16(Z)	AF26(Z)	AF38(Z)
Mounting positions				
Mounting distances	Max. add-on N.C. auxiliary contacts: see accessory fitting details for a 4-pole contactor AF09 ... AF38			
Fixing	The contactors can be assembled side by side			
	On rail according to IEC 60715, EN 60715	35 x 7.5 mm or 35 x 15 mm		
By screws (not supplied)	2 x M4 screws placed diagonally			

General technical data

A45...A75

Coil & mounting characteristics

Magnet system characteristics

Contactor types	AC operated	A45	A50	A75	
Coil operating limits acc. to IEC 60947-4-1	AC supply	At $\theta \leq 55\text{ °C}$ $0.85...1.1 \times U_c$ Please also refer to "Mounting characteristics and conditions for use"			
AC control voltage	Rated control circuit voltage U_c	at 50 Hz	24...690 V		
		at 60 Hz	24...690 V		
	Coil consumption	Average pull-in value	50 Hz	180 VA	
			60 Hz	210 VA	
		Average holding value	50/60 Hz (1)	190 VA / 180 VA	
			50 Hz	18 VA / 5.5 W	
	60 Hz	18 VA / 5.5 W			
	50/60 Hz (1)	18 VA / 5.5 W			
Drop-out voltage		approx. 40...65 % of U_c			
Operating time					
Between coil energization and:	N.O. contact closing	8...27 ms			
	N.C. contact opening	7...22 ms			
Between coil de-energization and:	N.O. contact opening	4...11 ms			
	N.C. contact closing	7...14 ms			

(1) 50/60 Hz coils: see "Coil voltage code table".

Mounting characteristics and conditions for use

Contactor types	AC operated	A45	A50	A75
Mounting positions		<p>Pos. 5 unauthorized for A45-22-00, A75-22-00</p> <p>Max. add-on N.O. or N.C. auxiliary contacts: see accessory fitting details for 4-pole contactor A45 ... A75</p>		
Control voltage / Ambient temperature	Mounting positions (1)	1, $1 \pm 30^\circ$, 2, 3, 4, 5	at $\theta \leq 55\text{ °C}$	$0.85...1.1 \times U_c$
			at $\theta \leq 70\text{ °C}$	U_c
	6	at $\theta \leq 55\text{ °C}$	$0.95...1.1 \times U_c$	
		at $\theta \leq 70\text{ °C}$	Unauthorized	
Mounting distances		The contactors can be assembled side by side		
Fixing	On rail according to IEC 60715, EN 60715	35 x 15 mm or 75 x 25 mm		
	By screws (not supplied)	2 x M6 screws placed diagonally		

(1) For 60 Hz coil voltage: (only for devices fitted with CA 5-.. and CAL 5-11 auxiliary contacts or TP timer).
 – A45-40-00, A50-40-00 and A75-40-00 contactors.
 Mounting positions 1 to 5 and ambient temperature $\leq 55\text{ °C}$: tolerance reduced to $0.9...1.1 U_c$ (instead of $0.85...1.1 U_c$) for coil voltage codes 70 to 79 and 80 to 89.
 – A45-22-00 and A75-22-00 contactors.
 Mounting positions 1 to 4 and ambient temperature $\leq 55\text{ °C}$: tolerance reduced to $0.9...1.1 U_c$ (instead of $0.85...1.1 U_c$) for coil voltage codes 70 to 79 and 80 to 89.
 For mounting position 6 or ambient temperature of 55 to 70 °C the information given on this page remains applicable.

General technical data

AE45...AE75

Coil & mounting characteristics

Magnet system characteristics

Contactor types	DC operated	AE45	AE50	AE75
Coil operating limits acc. to IEC 60947-4-1	DC supply	At $\theta \leq 55^\circ\text{C}$ $0.85...1.1 \times U_c$ Please also refer to "Mounting characteristics and conditions for use"		
DC control voltage	Rated control circuit voltage U_c	12...250 V DC		
	Coil consumption	Average pull-in value	200 W	
		Average holding value	4 W	
Drop-out voltage		approx. 15...40 % of U_c		
Coil time constant	Open	L/R	3 ms	
	Closed	L/R	15 ms	
Operating time	Between coil energization and:	N.O. contact closing	13...30 ms	
		N.C. contact opening	10...27 ms	
	Between coil de-energization and:	N.O. contact opening (1)	5...15 ms	
		N.C. contact closing (1)	8...18 ms	

(1) The use of surge suppressors increases the opening time with a factor of 1.1 to 1.5 for RV5 surge suppressor and a factor of 1.5 to 3 for RT5 surge suppressor.

Mounting characteristics and conditions for use

Contactor types	DC operated	AE45	AE50	AE75
Mounting positions		<p>Pos. 5 unauthorized for AE45-22-00, AE75-22-00</p> <p>Max. add-on N.O. or N.C. auxiliary contacts: see accessory fitting details for 4-pole contactor AE45 ... AE75 (1)(2)</p>		
Control voltage / Ambient temperature	Mounting positions 1, 1±30°, 2, 3, 4, 5	at $\theta \leq 55^\circ\text{C}$	$0.85...1.1 \times U_c$	
		at $\theta \leq 70^\circ\text{C}$	U_c	
	6	at $\theta \leq 55^\circ\text{C}$	$0.95...1.1 \times U_c$	
		at $\theta \leq 70^\circ\text{C}$	Unauthorized	
Mounting distances		The contactors can be assembled side by side		
Fixing	On rail according to IEC 60715, EN 60715	35 x 15 mm or 75 x 25 mm		
	By screws (not supplied)	2 x M6 screws placed diagonally		

General technical data

AF45...AF75

Coil & mounting characteristics

Magnet system characteristics

Contactor types	AC / DC operated	AF45	AF50	AF75
Coil operating limits acc. to IEC 60947-4-1	AC or DC supply	At $\theta \leq 70^\circ\text{C}$ $0.85 \times U_c \text{ min...} 1.1 \times U_c \text{ max.}$ Please also refer to "Mounting characteristics and conditions for use"		
AC control voltage 50/60 Hz	Rated control circuit voltage U_c	48...250 V		
	Coil consumption	Average pull-in value 210 VA		
		Average holding value 7 VA / 2.8 W		
DC control voltage	Rated control circuit voltage U_c	20...250 V DC		
	Coil consumption	Average pull-in value 190 W		
		Average holding value 2.8 W		
Drop-out voltage		55 % of U_c min.		
Voltage sag immunity acc. to SEMI F47		Conditions of use on request		
Dips withstand		≥ 20 ms		
Operating time				
Between coil energization and:	N.O. contact closing	30...100 ms		
	N.C. contact opening	27...95 ms		
Between coil de-energization and:	N.O. contact opening	30...110 ms		
	N.C. contact closing	35...115 ms		

Mounting characteristics and conditions for use

Contactor types	AC / DC operated	AF45	AF50	AF75
Mounting positions				
		Pos. 5 unauthorized for AF45-22-00, AF75-22-00 contactors Max. and add-on N.O. or N.C. auxiliary contacts: see accessory fitting details for 4-pole contactor AF45 ... AF110		
Control voltage / Ambient temperature				
Mounting positions 1, 1±30°, 2, 3, 4, 5	at $\theta \leq 70^\circ\text{C}$	0.85 x U_c min... 1.1 x U_c max.		
positions 6		Unauthorized		
Mounting distances		The contactors can be assembled side by side		
Fixing	On rail according to IEC 60715, EN 60715	35 x 15 mm or 75 x 25 mm		
	By screws (not supplied)	2 x M6 screws placed diagonally		

General technical data

EK110...EK1000

Coil & mounting characteristics

Magnet system characteristics

Contactor types	AC operated	EK110	EK150	EK175	EK210	EK370	EK550	EK1000	
Coil operating limits acc. to IEC 60947-4-1	AC supply	At $\theta \leq 70^\circ\text{C}$ $0.85 \times U_c \text{ min...} 1.1 \times U_c \text{ max.}$ Please also refer to "Mounting characteristics and conditions for use"							
AC control voltage	Rated control circuit voltage	50 Hz	24...500 V			48...500 V			
		60 Hz	24...600 V			110...600 V			
	Coil consumption	Average pull-in value	50 Hz	800 VA	1100 VA	3500 VA			
			60 Hz	900 VA	1200 VA	4000 VA			
	Average holding value	50/60 Hz (1)	500 / 500 VA	630 / 630 VA	3800 / 3400 VA				
		50 Hz	44 VA / 15 W	52 VA / 18 W	125 VA / 50 W				
Drop-out voltage in % of $U_c \text{ min.}$		60 Hz	52 VA / 18 W	65 VA / 22 W	140 VA / 60 W				
		50/60 Hz (1)	2.5 VA / 2.5 W	2.5 VA / 2.5 W	140 VA / 60 W				
			approx. 45...65 % (20...50 % for "E" coil voltage codes)					approx. 45...65 %	
Operating time									
Between coil energization and:	N.O. contact closing	20...40 (1) / 30...50 (2) ms					30...60 ms		
		N.C. contact opening					15...35 (1) / 25...45 (2) ms		
Between coil de-energization and:	N.O. contact opening	7.5...15 (1) / 9.5...120 (2) ms					10...20 ms		
		N.C. contact closing					10...18 (1) / 100...125 (2) ms		

(1) "A" coil voltage: see "Coil voltage code table".

(2) 50/60 Hz "E" coil voltage codes, see "Coil voltage code table".

Magnet system characteristics

Contactor types	DC operated	EK110	EK150	EK175	EK210	EK370	EK550	EK1000	
Coil operating limits acc. to IEC 60947-4-1	DC supply	At $\theta \leq 70^\circ\text{C}$ $0.85 \times U_c \text{ min...} 1.1 \times U_c \text{ max.}$ Please also refer to "Mounting characteristics and conditions for use"							
DC control voltage	Rated control circuit voltage	12...220					24...220		
		Coil consumption	Average pull-in value	500 W		630 W	1100 W		
				Average holding value		2.5 W	2.5 W	20 W	
Drop-out voltage		approx. 15...50 % of $U_c \text{ min.}$							
Coil time constant	Open	L/R	8 ms			12 ms			
	Closed	L/R	50 ms			60 ms			
Operating time									
Between coil energization and:	N.O. contact closing	30...50 ms					60...80 ms		
		N.C. contact opening					27...47 ms		
Between coil de-energization and:	N.O. contact opening	10...35 ms							
		N.C. contact closing					13...38 ms		

Mounting characteristics and conditions for use

Contactor types	AC / DC operated	EK110	EK150	EK175	EK210	EK370	EK550	EK1000
Mounting positions								
Control voltage / Ambient temperature		Max. N.O. or N.C. built-in and add-on N.O. or N.C. auxiliary contacts: see accessory fitting details for 4-pole contactor EK110 ... EK1000						
Mounting positions	1, 1±30°, 2, 3, 4, 5	at $\theta \leq 70^\circ\text{C}$		0.85...1.1 x U_c				
	2	at $\theta \leq 70^\circ\text{C}$		Unauthorized		0.85...1.1 x U_c		
	6	at $\theta \leq 70^\circ\text{C}$		Unauthorized				
Mounting distances		The contactors can be assembled side by side						
Fixing	On rail according to IEC 60715, EN 60715	-						
	By screws (supplied)	4 x M6				4 x M6 (1)		

(1) Damping elements are supplied.

General technical data

AF09(Z)...AF38(Z), 4-pole

General technical data

Contactor types	AF09(Z)	AF16(Z)	AF26(Z)	AF38(Z)
Rated insulation voltage Ui acc. to IEC 60947-4-1 acc. to UL / CSA	690 V 600 V			
Rated impulse withstand voltage Uimp.	6 kV			
Electromagnetic compatibility	Devices complying with IEC 60947-1 / EN 60947-1 - Environment A			
Ambient air temperature close to contactor				
Operation	-40...+70 °C			
Storage	-60...+80 °C			
Climatic withstand	Category B according to IEC 60947-1 Annex Q			
Maximum operating altitude (without derating)	3000 m			
Mechanical durability				
Number of operating cycles	10 millions operating cycles			
Max. switching frequency	3600 cycles/h			
Shock withstand acc. to IEC 60068-2-27 and EN 60068-2-27				
Mounting position 1				
	Shock direction	1/2 sinusoidal shock for 11 ms: no change in contact position, closed or open position		
	A	30 g		
	B1	25 g closed position / 5 g open position		
	B2	15 g		
	C1	25 g		
	C2	25 g		
	A	30 g	30 g closed position / 25 g open position	
	B1	25 g closed position / 5 g open position	25 g closed position / 5 g open position	
	B2	15 g	15 g closed position / 10 g open position	
	C1	25 g	25 g closed position / 20 g open position	
	C2	25 g	25 g closed position / 20 g open position	
Vibration withstand acc. to IEC 60068-2-6				
		5...300 Hz		
		4 g closed position / 2 g open position		

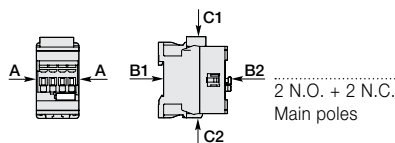

General technical data

A/E/F45...A/E/F75, 4-pole

General technical data

Contactor types	AC operated	A45	A50	A75
	DC operated	AE45	AE50	AE75
		TAE45	TAE50	TAE75
	AC / DC operated	AF45	AF50	AF75
Rated insulation voltage U_i				
acc. to IEC 60947-4-1		1000 V		
acc. to UL / CSA		600 V		
Rated impulse withstand voltage U_{imp}				
8 kV				
Electromagnetic compatibility				
AF contactors complying with IEC 60947-1 / EN 60947-1 - Environment A				
Ambient air temperature close to contactor				
Operation		-40...+70 °C (1)		
Storage		-60...+80 °C		
Climatic withstand				
acc. to IEC 60068-2-30 and 60068-2-11 - UTE C 63-100 specification II				
Maximum operating altitude (without derating)				
3000 m				
Mechanical durability				
Number of operating cycles		10 millions operating cycles (5 millions for AE... and TAE... contactors)		
Max. switching frequency		3600 cycles/h (300 for AF..)		
Shock withstand				
acc. to IEC 60068-2-27 and EN 60068-2-27				
Mounting position 1				
<p>4 N.O. Main poles</p> <p>2 N.O. + 2 N.C. Main poles</p>		Shock direction	1/2 sinusoidal shock for 11 ms: no change in contact position, closed or open position	
		A	20 g	
		B1	10 g closed position / 5 g open position	
		B2	15 g	
		C1	20 g	
		C2	20 g	
		A	20 g	
		B1	10 g closed position / 5 g open position (2)	
		B2	15 g (3)	
		C1	20 g	
C2	20 g			

(1) 55 °C max. for TAE... contactors.

(2) 3 g in open position for AF 45-22, AE 45-22, AF 75-22 and AE 75-22.

(3) 10 g for AF 45-22, AE 45-22, AF 75-22 and AE 75-22.

General technical data

EK110...EK1000, 4-pole

General technical data

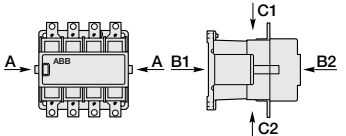







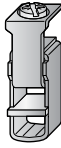

Contactor types	AC or DC operated	EK110	EK150	EK175	EK210	EK370	EK550	EK1000
Rated insulation voltage U_i acc. to IEC 60947-4-1		1000 V						
acc. to UL		600 V						
Rated impulse withstand voltage U_{imp}		8 kV						
Electromagnetic compatibility		EK contactors complying with IEC 60947-1 / EN 60947-1 - Environment A						
Ambient air temperature close to contactor								
Operation	Fitted with thermal overload relay	-25 to +55 °C						-
	Without thermal overload relay	-40 to +70 °C						-
Storage		-50 to +70 °C						-
Climatic withstand		Category B acc. to IEC 60068-2-30						
Maximum operating altitude (without derating)		≤ 3000 m						
Mechanical durability								
Number of operating cycles		10 millions operating cycles				5 millions operating cycles		3 millions operating cycles
Max. switching frequency		3600 cycles/h				60 cycles/h		
Shock withstand acc. to IEC 60068-2-27 and EN 60068-2-27								
Mounting position 1								
								
	Closed or open position							
	Shock direction	1/2 sinusoidal shock for 15 ms: no change in contact position, closed or open position						
	A	10 g						
	B1	10 g						
	B2	10 g						
	C1	10 g						
	C2	10 g						

General technical data

AF09(Z)...AF38(Z), 4-pole

Terminal characteristics

Connecting characteristics











Contactor types	AF09(Z)	AF16(Z)	AF26(Z)	AF38(Z)
Main terminals				
	Screw terminals with cable clamp		Screw terminals with double connector 2 x (5.5 width x 6.8 depth)	
Connection capacity (min. ... max.)				
Main conductors (poles)				
 Rigid	Solid ($\leq 4 \text{ mm}^2$)	} 1 x 1...6 mm ² 2 x 1...6 mm ²	1.5...16 mm ²	
 Rigid	Stranded ($\geq 6 \text{ mm}^2$)		1.5...16 mm ²	
 Flexible with non insulated ferrule		1 x 0.75...6 mm ² 2 x 0.75...6 mm ²	1.5...16 mm ² 1.5...16 mm ²	
 Flexible with insulated ferrule		1 x 0.75...4 mm ² 2 x 0.75...2.5 mm ²	1.5...16 mm ² 1.5...16 mm ²	
 Bars or lugs		L < 9.6 mm	-	
Connection capacity acc. to UL/CSA (Sol/Str)	1 or 2 x	AWG 16...10	AWG 16...6	
Stripping length		10 mm	12 mm	
Tightening torque		1.5 Nm / 13 lb.in	2.5 Nm / 22 lb.in	
Auxiliary conductors (coil terminals)				
 Rigid solid		1 x 1...2.5 mm ² 2 x 1...2.5 mm ²		
 Flexible with non insulated ferrule		1 x 0.75...2.5 mm ² 2 x 0.75...2.5 mm ²		
 Flexible with insulated ferrule		1 x 0.75...2.5 mm ² 2 x 0.75...1.5 mm ²		
 Lugs		L < 8 mm		
Connection capacity acc. to UL/CSA (Sol/Str)	1 or 2 x	AWG 18...14		
Stripping length		10 mm		
Tightening torque		1.2 Nm / 11 lb.in		
Degree of protection acc. to IEC 60947-1 / EN 60947-1 and IEC 60529 / EN 60529				
Main terminals		IP20		
Coil terminals		IP20		
Screw terminals Delivered in open position, screws of unused terminals must be tightened				
Main terminals		M3.5	M4.5	
	Screwdriver type	Flat Ø 5.5 / Pozidriv 2		
Coil terminals		M3.5		
	Screwdriver type	Flat Ø 5.5 / Pozidriv 2		

General technical data

A/E/F45...A/E/F75

Terminal characteristics

Connecting characteristics







Contactor types	AC operated	A45	A50	A75
	DC operated	AE45	AE50	AE75
		TAE45	TAE50	TAE75
	AC / DC operated	AF45	AF50	AF75
Main terminals				
 <p>Screw terminals with single connector (13 x 10 mm)</p>				
Connection capacity (min. ... max.)				
Main conductors (poles)				
	Rigid	Solid ($\leq 4 \text{ mm}^2$)	} 1 x	6...50 mm ²
		Stranded ($\geq 6 \text{ mm}^2$)		2 x
	Flexible with ferrule		1 x	6...35 mm ²
			2 x	6...16 mm ²
	Bars or lugs		L \leq	-
			L $>$	-
Connection capacity acc. to UL/CSA (Sol/Str)			1 or 2 x	AWG 8...1
Tightening torque		Recommended	4.00 Nm / 35 lb.in	
		Max.	4.50 Nm	
Auxiliary conductors (built-in auxiliary terminals + coil terminals)				
	Rigid solid		1 x	1...4 mm ²
			2 x	1...4 mm ²
	Flexible with ferrule		1 x	1...2.5 mm ²
			2 x	0.75...2.5 mm ²
	Lugs		L \leq	8 mm
			L $>$	3.7 mm
Connection capacity acc. to UL/CSA (Sol/Str)			1 or 2 x	AWG 18...14
Tightening torque		Recommended	1.00 Nm / 9 lb.in	
		Max.	1.20 Nm	
Degree of protection acc. to IEC 60947-1 / EN 60947-1 and IEC 60529 / EN 60529				
Main terminals			IP10	
Coil terminals			IP20	
Screw terminals				
Main terminals			Delivered in open position, screws of unused terminals must be tightened	
			M6	
			Screwdriver type	
			Flat \varnothing 6.5 / Pozidriv 2	
Coil terminals			M3.5	
			Screwdriver type	
			Flat \varnothing 5.5 / Pozidriv 2	

General technical data

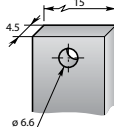
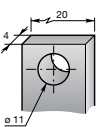
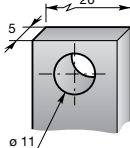
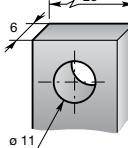
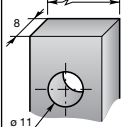
EK110...EK1000

Terminal characteristics

Connecting characteristics

Contactor types	AC or DC operated	EK110	EK150	EK175	EK210	EK370	EK550	EK1000
Main terminals Flat type								
Connection capacity (min. ... max.)								
Main conductors (poles)								
	Rigid with connector	Single for Cu cable	25...120 mm ²	25...185 mm ²	25...185 mm ²	70...300 mm ²		-
		Single for Al/Cu cable	10...70 mm ²	35...120 mm ²	35...120 mm ²	70...300 mm ²		95...300 mm ²
		Double for Al/Cu cable	-	-	-	2 x 35...185		2 x 95...300
	Bars or lugs	L ≤	30 mm	30 mm	33 mm	33 mm	55 mm	55 mm
		Ø >	6 mm	10 mm	10 mm	10 mm	10 mm	10 mm
		Connection capacity acc. to UL/CSA	1 or 2 x	8 - 3/0 AWG	6 - 250 MCM	2 x 4 - 500 MCM	3 x 4 - 500 MCM	-
		Tightening torque	Recommended	5 Nm/44 lb.in	18 Nm / 160 lb.in			
			Max.	6 Nm	22 Nm			
Auxiliary conductors (coil terminals)								
	Rigid solid	1 x	0.5...2.5 mm ²					
		2 x	0.5...2.5 mm ²					
	Flexible with ferrule	1 x	0.5...2.5 mm ²					
		2 x	0.5...2.5 mm ²					
	Bars or lugs	L ≤	8 mm					
		l >	3.7 mm					
		Connection capacity acc. to UL/CSA (Sol/Str)	1 or 2 x	18...14 AWG				
		Tightening torque	Recommended	1.00 Nm / 9 lb.in				
			Max.	1.20 Nm				
Degree of protection								
acc. to IEC 60947-1 / EN 60947-1 and IEC 60529 / EN 60529								
	Main terminals		IP00					
	Coil terminals		IP20					
Screw terminals								
	Main terminals		M6		M10			
			Screws and bolts					
	Coil terminals (delivered in open positions)		M3.5					
		Screwdriver type	Flat Ø 5.5 mm / Pozidriv 2					

IEC Technical data

AF09(Z)...AF38(Z), 3 & 4-pole

DC circuit switching

General

The arc switching on DC is more difficult than on AC.

- For selecting a contactor it is essential to determine the current, the voltage and the L/R time constant of the controlled load.
- For information, typical time constant values are quoted hereafter: non inductive loads such as resistance furnaces (L/R ≈ 1 ms), inductive loads such as shunt motors (L/R ≈ 2 ms) or series motors (L/R ≈ 7.5 ms).
- The addition of a resistor in parallel with an inductive winding helps in the elimination of the arcs.
- All the poles required for breaking must be connected in series between the load and the source polarity not linked to earth (or chassis).

Technical Data

- The tables indicate for the standard contactors the le max. operating currents depending on: the utilization category (i.e. L/R) DC-1, DC-3, DC-5 as defined in the IEC 60947-4-1 publication, the operating voltage Ue and the pole coupling details.

Ampere values quoted in these tables are valid for a -25 ... +70 °C temperature close to the contactors, as long as these values do not exceed the AC-1 Ampere values for the corresponding ambient temperature.

- Max. switching frequency: 300 cycles/h.

Selection table

Contactor types	AF09	AF12	AF16	AF26		AF30	AF38	
	3 or 4-pole			3-pole	4-pole	3-pole	3-pole	4-pole

Utilization category DC-1, L/R ≤ 1 ms

	≤ 72 V	25 A	27 A	30 A	45 A	45 A	50 A	50 A	55 A
	110 V	10 A	15 A	20 A	—	—	—	—	—
	220 V	—	—	—	—	—	—	—	—
	≤ 72 V	25 A	27 A	30 A	45 A	45 A	50 A	50 A	55 A
	110 V	25 A	27 A	30 A	45 A	45 A	50 A	50 A	55 A
	220 V	10 A	15 A	20 A	—	—	—	—	—
	≤ 72 V	25 A	27 A	30 A	45 A	45 A	50 A	50 A	55 A
	110 V	25 A	27 A	30 A	45 A	45 A	50 A	50 A	55 A
	220 V	25 A	27 A	30 A	45 A	45 A	50 A	50 A	55 A
	≤ 72 V	25 A	—	30 A	—	45 A	—	—	55 A
	110 V	25 A	—	30 A	—	45 A	—	—	55 A
	220 V	25 A	—	30 A	—	45 A	—	—	55 A
	440 V	10 A	—	20 A	—	—	—	—	—

Utilization category DC-3, L/R ≤ 2 ms

	≤ 72 V	25 A	27 A	30 A	45 A	—	50 A	50 A	—
	110 V	6 A	7 A	8 A	—	—	—	—	—
	220 V	—	—	—	—	—	—	—	—
	≤ 72 V	25 A	27 A	30 A	45 A	—	50 A	50 A	—
	110 V	25 A	27 A	30 A	45 A	—	50 A	50 A	—
	220 V	6 A	7 A	8 A	—	—	—	—	—
	≤ 72 V	25 A	27 A	30 A	45 A	—	50 A	50 A	—
	110 V	25 A	27 A	30 A	45 A	—	50 A	50 A	—
	220 V	25 A	27 A	30 A	45 A	—	50 A	50 A	—
	≤ 72 V	25 A	—	30 A	—	—	—	—	—
	110 V	25 A	—	30 A	—	—	—	—	—
	220 V	25 A	—	30 A	—	—	—	—	—
	440 V	6 A	—	8 A	—	—	—	—	—

Utilization category DC-5, L/R ≤ 7.5 ms

	≤ 72 V	9 A	12 A	16 A	20 A	—	25 A	25 A	—
	110 V	4 A	4 A	4 A	—	—	—	—	—
	220 V	—	—	—	—	—	—	—	—
	≤ 72 V	25 A	27 A	30 A	45 A	—	50 A	50 A	—
	110 V	10 A	15 A	20 A	45 A	—	50 A	50 A	—
	220 V	4 A	4 A	4 A	—	—	—	—	—
	≤ 72 V	25 A	27 A	30 A	45 A	—	50 A	50 A	—
	110 V	25 A	27 A	30 A	45 A	—	50 A	50 A	—
	220 V	9 A	12 A	16 A	20 A	—	25 A	25 A	—
	≤ 72 V	25 A	—	30 A	—	—	—	—	—
	110 V	25 A	—	30 A	—	—	—	—	—
	220 V	10 A	—	20 A	—	—	—	—	—
	440 V	4 A	—	4 A	—	—	—	—	—

IEC technical data







A/E/L9...A/E/F75, GA/E75, 3 & 4-pole

DC Circuit switching

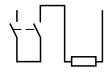
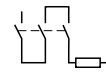
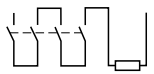
General

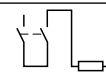
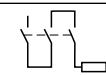
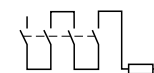
The arc switching on d.c. is more difficult than on a.c.

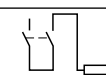
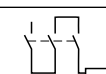
- For selecting a contactor it is essential to determine the current, the voltage and the L/R time constant of the controlled load.
- For information, typical time constant values are quoted hereafter: non-inductive loads such as resistance furnaces ($L/R \approx 1$ ms), inductive loads such as shunt motors ($L/R \approx 2$ ms) or series motors ($L/R \approx 7.5$ ms).
- The addition of a resistor in parallel with an inductive winding helps in the elimination of the arcs.
- All the poles required for breaking must be connected in series between the load and the source polarity not linked to earth (or chassis).

a.c. operated contactors a.c. / d.c. operated (electronic coil interface) d.c. operated contactors	A9 - AE9	A12 - AE12	A16 - AE16	A26 - AE26	A30 - AE30	A40 - AE40	A45 AF45 AE45	A50 AF50 AE50	A63 AF63 AE63	A75 AF75 AE75	GA75 - GAE75	
Utilization category DC-1, L/R ≤ 1 ms												
	≤ 72 V	A 25	27	30	45	55	60	70	100	110	120	120
	110 V	A 10	15	20	-	-	-	-	-	-	-	120
	220 V	A -	-	-	-	-	-	-	-	-	-	120
	440 V	A -	-	-	-	-	-	-	-	-	-	100
	600 V	A -	-	-	-	-	-	-	-	-	-	75
	≤ 72 V	A 25	27	30	45	55	60	70	100	110	120	-
	110 V	A 25	27	30	45	55	60	70	100	110	120	-
	220 V	A 10	15	20	-	-	-	-	-	-	-	-
	≤ 72 V	A 25	27	30	45	55	60	70	100	110	120	-
	110 V	A 25	27	30	45	55	60	70	100	110	120	-
	220 V	A 25	27	30	45	55	60	70	100	110	120	-
	≤ 72 V	A 25	27	30	45	-	-	70	100	-	120	-
	110 V	A 25	27	30	45	-	-	70	100	-	120	-
	220 V	A 25	27	30	45	-	-	70	100	-	120	-
	440 V	A 10	15	20	-	-	-	-	-	-	-	-
Utilization category DC-3, L/R ≤ 2 ms												
	≤ 72 V	A 25	27	30	45	55	60	70	100	110	120	120
	110 V	A 6	7	8	-	-	-	-	-	-	-	120
	220 V	A -	-	-	-	-	-	-	-	-	-	100
	440 V	A -	-	-	-	-	-	-	-	-	-	85
	≤ 72 V	A 25	27	30	45	55	60	70	100	110	120	-
	110 V	A 25	27	30	45	55	60	70	100	110	120	-
	220 V	A 6	7	8	-	-	-	-	-	-	-	-
	≤ 72 V	A 25	27	30	45	55	60	70	100	110	120	-
	110 V	A 25	27	30	45	55	60	70	100	110	120	-
	220 V	A 25	27	30	45	55	60	70	100	110	120	-
	≤ 72 V	A 25	27	30	45	-	-	70	100	-	120	-
	110 V	A 25	27	30	45	-	-	70	100	-	120	-
	220 V	A 25	27	30	45	-	-	70	100	-	120	-
	440 V	A 6	7	8	-	-	-	-	-	-	-	-
Utilization category DC-5, L/R ≤ 7.5 ms												
	≤ 72 V	A 9	12	16	25	30	40	50	50	63	75	85
	110 V	A 4	4	4	-	-	-	-	-	-	-	85
	220 V	A -	-	-	-	-	-	-	-	-	-	85
	440 V	A -	-	-	-	-	-	-	-	-	-	35
	≤ 72 V	A 25	27	30	45	55	60	70	100	110	120	-
	110 V	A 10	15	20	30	45	50	70	80	90	100	-
	220 V	A 4	4	4	-	-	-	-	-	-	-	-
	≤ 72 V	A 25	27	30	45	55	60	70	100	110	120	-
	110 V	A 25	27	30	45	55	60	70	100	110	120	-
	220 V	A 9	12	16	25	30	40	50	50	63	75	-
	≤ 72 V	A 25	27	30	45	-	-	70	100	-	120	-
	110 V	A 25	27	30	45	-	-	70	100	-	120	-
	220 V	A 10	15	20	30	-	-	70	70	-	100	-
	440 V	A 4	4	4	-	-	-	-	-	-	-	-

IEC Technical data









A/F95...AF750, B/C6...B/C7, 3-pole

DC circuit switching

Technical Data

- The tables indicate for the standard contactors the I_n max. operating currents depending on: the utilization category (i.e. L/R) DC-1, DC-3, DC-5 as defined in the IEC 60947-4-1 publication, the operating voltage U_o and the pole coupling details. See page 1.81.
Ampere values quoted in the tables below are valid for a -25 ... +70 °C temperature close to the contactors, as long as the AC-1 Ampere values (see pages 1.45 - 146) for the corresponding ambient temperature are not exceeded.
- Max. switching frequency: 300 ops/h.
- For switching higher d.c. ratings, we recommend the use of bar mounted contactors, R series (63 ... 2000 A).

The selection table for AE 50 ... AE 110 contactors can be used for the TAE 50 ... TAE 110 types.

a.c. operated contactors a.c. / d.c. operated (electronic coil interface) d.c. operated contactors		A95 AF95	A110 AF110	A145 AF145	A185 AF185	A210 AF210	A260 AF260	A300 AF300	- AF400	- AF460	- AF580	- AF750	
Utilization category DC-1, L/R ≤ 1 ms													
	≤110 V	A	-	-	-	-	-	-	600	700	800	1050	
	≤110 V	A	145	160	250	275	350	400	450	600	700	800	1050
	220 V	A	-	-	-	-	-	-	600	700	800	1050	
	≤110 V	A	145	160	250	275	350	400	450	600	700	800	1050
	220 V	A	145	160	250	275	350	400	450	600	700	800	1050
	440 V	A	-	-	-	-	-	-	600	700	800	1050	
	600 V	A	-	-	-	-	-	-	600	700	800	1050	
Utilization category DC-3, L/R ≤ 2.5 ms													
	≤110 V	A	-	-	-	-	-	-	600	700	800	1050	
	≤110 V	A	145	160	250	275	350	400	450	600	700	800	1050
	220 V	A	-	-	-	-	-	-	600	700	800	1050	
	≤110 V	A	145	160	250	275	350	400	450	600	700	800	1050
	220 V	A	145	160	250	275	350	400	450	600	700	800	1050
	440 V	A	-	-	-	-	-	-	600	700	800	1050	
	600 V	A	-	-	-	-	-	-	600	700	800	1050	
Utilization category DC-5, L/R ≤ 15 ms													
	≤110 V	A	-	-	-	-	-	-	600	700	800	1050	
	≤110 V	A	145	160	250	275	350	400	450	600	700	800	1050
	220 V	A	-	-	-	-	-	-	600	700	800	1050	
	≤110 V	A	145	160	250	275	350	400	450	600	700	800	1050
	220 V	A	145	160	250	275	350	400	450	600	700	800	1050
	440 V	A	-	-	-	-	-	-	600	700	800	1050	
	600 V	A	-	-	-	-	-	-	600	700	800	1050	

D.C. Power circuit switching

Utilization category		DC-1 L/R ≤ 1 ms	DC-3 L/R ≤ 2 ms	DC-5 L/R ≤ 7.5 ms
24 V	A	16.0	16.0	16.0
48 V	A	16.0	8.0	2.0
60 V	A	16.0	4.0	1.25
110 V	A	7.0	1.5	0.4
220 V	A	0.8	0.25	0.2
<hr/>				
24 V	A	16.0	16.0	16.0
48 V	A	16.0	16.0	16.0
60 V	A	16.0	15.0	12.0
110 V	A	16.0	7.0	2.0
220 V	A	5.0	1.5	0.5
<hr/>				
24 V	A	16.0	16.0	16.0
48 V	A	16.0	16.0	16.0
60 V	A	16.0	16.0	16.0
110 V	A	16.0	15.0	8.0
220 V	A	14.0	4.0	2.0

IEC Technical data

AL9 – AL40

DC circuit switching

General

The arc switching on d.c. is more difficult than on a.c.

- For selecting a contactor it is essential to determine the current, the voltage and the L/R time constant of the controlled load.
- For information, typical time constant values are quoted hereafter: non inductive loads such as resistance furnaces ($L/R \approx 1$ ms), inductive loads such as shunt motors ($L/R \approx 2$ ms) or series motors ($L/R \approx 7.5$ ms).
- The addition of a resistor in parallel with an inductive winding helps in the elimination of the arcs.
- All the poles required for breaking must be connected in series between the load and the source polarity not linked to earth (or chassis).

A.C. operated contactors		AL9	AL12	AL16	AL26	AL30	AL40	
Utilization category DC-1, $L/R \leq 1$ ms								
	≤ 72 V	A	25	27	30	45	55	60
	110 V	A	10	15	20	–	–	–
	220 V	A	–	–	–	–	–	–
	440 V	A	–	–	–	–	–	–
	600 V	A	–	–	–	–	–	–
	≤ 72 V	A	25	27	30	45	55	60
	110 V	A	25	27	30	45	55	60
	220 V	A	10	15	20	–	–	–
	≤ 72 V	A	25	27	30	45	55	60
	110 V	A	25	27	30	45	55	60
	220 V	A	25	27	30	45	55	60
	≤ 72 V	A	25	27	30	45	–	–
	110 V	A	25	27	30	45	–	–
	220 V	A	25	27	30	45	–	–
	440 V	A	10	15	20	–	–	–
Utilization category DC-3, $L/R \leq 2$ ms								
	≤ 72 V	A	25	27	30	45	55	60
	110 V	A	6	7	8	–	–	–
	220 V	A	–	–	–	–	–	–
	440 V	A	–	–	–	–	–	–
	≤ 72 V	A	25	27	30	45	55	60
	110 V	A	25	27	30	45	55	60
	220 V	A	6	7	8	–	–	–
	≤ 72 V	A	25	27	30	45	55	60
	110 V	A	25	27	30	45	55	60
	220 V	A	25	27	30	45	55	60
	≤ 72 V	A	25	27	30	45	–	–
	110 V	A	25	27	30	45	–	–
	220 V	A	25	27	30	45	–	–
	440 V	A	6	7	8	–	–	–
Utilization category DC-5, $L/R \leq 7.5$ ms								
	≤ 72 V	A	9	12	16	25	30	40
	110 V	A	4	4	4	–	–	–
	220 V	A	–	–	–	–	–	–
	440 V	A	–	–	–	–	–	–
	≤ 72 V	A	25	27	30	45	55	60
	110 V	A	10	15	20	30	45	50
	220 V	A	4	4	4	–	–	–
	≤ 72 V	A	25	27	30	45	55	60
	110 V	A	25	27	30	45	55	60
	220 V	A	9	12	16	25	30	40
	≤ 72 V	A	25	27	30	45	–	–
	110 V	A	25	27	30	45	–	–
	220 V	A	10	15	20	30	–	–
	440 V	A	4	4	4	–	–	–

IEC Technical data

EK110 – EK1000

DC circuit switching

General

The arc switching on d.c. is more difficult than on a.c.

- For selecting a contactor it is essential to determine the current, the voltage and the L/R time constant of the controlled load.
- For information, typical time constant values are quoted hereafter: non inductive loads such as resistance furnaces ($L/R \approx 1$ ms), inductive loads such as shunt motors ($L/R \approx 2$ ms) or series motors ($L/R \approx 7.5$ ms).
- The addition of a resistor in parallel with an inductive winding helps in the elimination of the arcs.
- All the poles required for breaking must be connected in series between the load and the source polarity not linked to earth (or chassis).

Technical Data









- The tables indicate for the standard contactors the I_o max. operating currents depending on: the utilization category (i.e. L/R) DC-1, DC-3, DC-5 as defined in the IEC 60947-4-1 publication (see page 1.75 for more details), the operating voltage U_o and the pole coupling details.

Ampere values quoted in the tables below are valid for a $-25 \dots +70$ °C temperature close to the contactors, as long as the AC-1 Ampere values (see page 1.61) for the corresponding ambient temperature are not exceeded.

- Max. switching frequency: 300 ops/h.
- For switching higher d.c. ratings, we recommend the use of bar mounted contactors, R series (63 ... 2000 A).

Selection Table

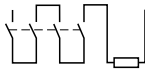
a.c. / d.c. operated contactors

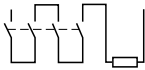
			EK110	EK150	EK175	EK210	EK370	EK550	EK1000
Utilization category DC-1, $L/R \leq 1$ ms									
	≤ 72 V	A	120	145	210	210	370	550	–
	110 V	A	120	145	210	210	370	550	–
	≤ 72 V	A	200	200	300	300	550	800	–
	110 V	A	200	200	300	300	550	800	–
	220 V	A	200	200	300	300	550	800	–
	≤ 72 V	A	200	200	300	300	550	800	–
	110 V	A	200	200	300	300	550	800	–
	220 V	A	200	200	300	300	550	800	–
	440 V	A	–	–	210	210	450	650	–
	600 V	A	–	–	–	–	450	650	–
	≤ 72 V	A	200	200	300	300	550	800	–
	110 V	A	200	200	300	300	550	800	–
	220 V	A	200	200	300	300	550	800	–
	440 V	A	200	200	260	300	450	650	–
	600 V	A	–	–	260	300	450	650	–
Utilization category DC-3, $L/R \leq 2$ ms									
	≤ 72 V	A	120	145	210	210	370	550	–
	≤ 72 V	A	135	145	210	210	450	650	–
	110 V	A	135	135	210	210	450	650	–
	220 V	A	135	135	210	210	450	650	–
	≤ 72 V	A	135	145	210	210	450	650	–
	110 V	A	135	135	210	210	450	650	–
	220 V	A	135	135	210	210	450	650	–
	440 V	A	–	–	210	210	450	650	–
	600 V	A	–	–	–	–	450	650	–
	≤ 72 V	A	135	145	210	210	450	650	–
	110 V	A	135	135	210	210	450	650	–
	220 V	A	135	135	210	210	450	650	–
	440 V	A	135	135	210	210	450	650	–
	600 V	A	–	–	170	210	450	650	–
Utilization category DC-5, $L/R \leq 7.5$ ms									
	≤ 72 V	A	135	145	210	210	450	650	–
	110 V	A	135	135	210	210	450	650	–
	220 V	A	135	135	210	210	450	650	–
	≤ 72 V	A	135	145	210	210	450	650	–
	110 V	A	135	135	210	210	450	650	–
	220 V	A	135	135	210	210	450	650	–
	440 V	A	–	–	210	210	450	650	–
	600 V	A	–	–	–	–	450	650	–
	≤ 72 V	A	135	145	210	210	450	650	–
	110 V	A	135	135	210	210	450	650	–
	220 V	A	135	135	210	210	450	650	–
	440 V	A	135	135	210	210	450	650	–
	600 V	A	–	–	170	210	450	650	–

IEC Technical data

3-pole contactors

Electrical durability and utilization categories

General

Utilization categories determine the current making and breaking conditions relating to the characteristics of the loads to be controlled by the contactors. International standard IEC 60947-4-1 and European standard EN 60947-4-1 are the standards to be referred to.

If I_c is the current to be broken by the contactor and I_e the rated operational current normally drawn by the load, then:

- Categories AC-1 and AC-3: $I_c = I_e$
- Category AC-2: $I_c = 2.5 \times I_e$
- Category AC-4: $I_c = 6 \times I_e$

Generally speaking $I_c = m \times I_e$ where m is a multiple of the load operational current.

On next pages, the curves corresponding to categories AC-1, AC-3 and AC-4 represent the electrical durability variation of standard contactors in relation to the breaking current I_c .

Electrical durability is expressed in millions of operating cycles.

Curve utilization mode

Electrical durability forecast and contactor selection for categories AC-1, AC-2, AC-3 or AC-4

- Note the characteristics of the load to be controlled:
 - Operational voltage U_e
 - Current normally drawn I_e (U_e / I_e / kW relation for motors, see "Motor rated operational powers and currents").
 - Utilization category AC-1, AC-2, AC-3 or AC-4
 - Breaking current $I_c = I_e$ for AC-1 and for AC-3 ; $I_c = 2.5 \times I_e$ for AC-2 ; $I_c = 6 \times I_e$ for AC-4
- Define the number of operating cycles N required.
- On the diagram corresponding to the operational category, select the contactor with the curve immediately above the intersection point (I_c ; N).

Electrical durability forecast and contactor selection for mixed duty motor control: AC-3 ($I_c = I_e$) type switching off while "motor running" and, occasionally, AC-4 ($I_c = 6 \times I_e$) type switching off while "motor accelerating"

- Note the characteristics of the motor to be controlled:
 - Operational voltage U_e
 - Current normally drawn while "motor running" I_e (U_e / I_e / kW relation for motors, see "Motor rated operational powers and currents")
 - Breaking current for AC-3 $I_c = I_e$
 - Breaking current for AC-4 while "motor accelerating" $I_c = 6 \times I_e$
 - Percentage of AC-4 operating cycles K (on the basis of the total number of operating cycles)
 - Define the total number of operating cycles N required.
 - Note the smallest contactor rating compatible for AC-3 (U_e / I_e) on Main pole utilization characteristic table (see "Technical data").
 - For the selected contactor make a note of the following in relation to the voltage using diagram AC-3 in next pages:
 - The number of operating cycles A for $I_c = I_e$ (AC-3)
 - The number of operating cycles B for $I_c = 6 \times I_e$ (AC-4)
 - Calculate the estimated number of cycles N' (N' is always below A)
- $$N' = \frac{A}{1 + 0.01 K (A/B - 1)}$$
- If N' is too low in relation to the target N , calculate the estimated number of cycles for a higher contactor rating.

Case of uninterrupted duty

For uninterrupted duty, some verifications of preventing maintenance are necessary to check the functionality of the concerned product (consult us).

The combined effect of environmental conditions and the proper temperature of the product may require some disposals. As a matter of fact, for this duty, the use duration prevails over the number of operating cycles.

IEC Technical data

3-pole contactors

Electrical durability (AC-1)

Electrical durability for AC-1 utilization category - $U_e \leq 690$ V

Ambient temperature ≤ 60 °C for AF09(Z)...AF38(Z), ≤ 55 °C for A40 ... AF2050

Switching non-inductive or slightly inductive loads. The breaking current I_c for AC-1 is equal to the rated operational current of the load.

Maximum electrical switching frequency: see "Technical data".

AF1250, AF1350, AF1650, AF2050:
The electrical durability at the rated current is 50000 operating cycles.

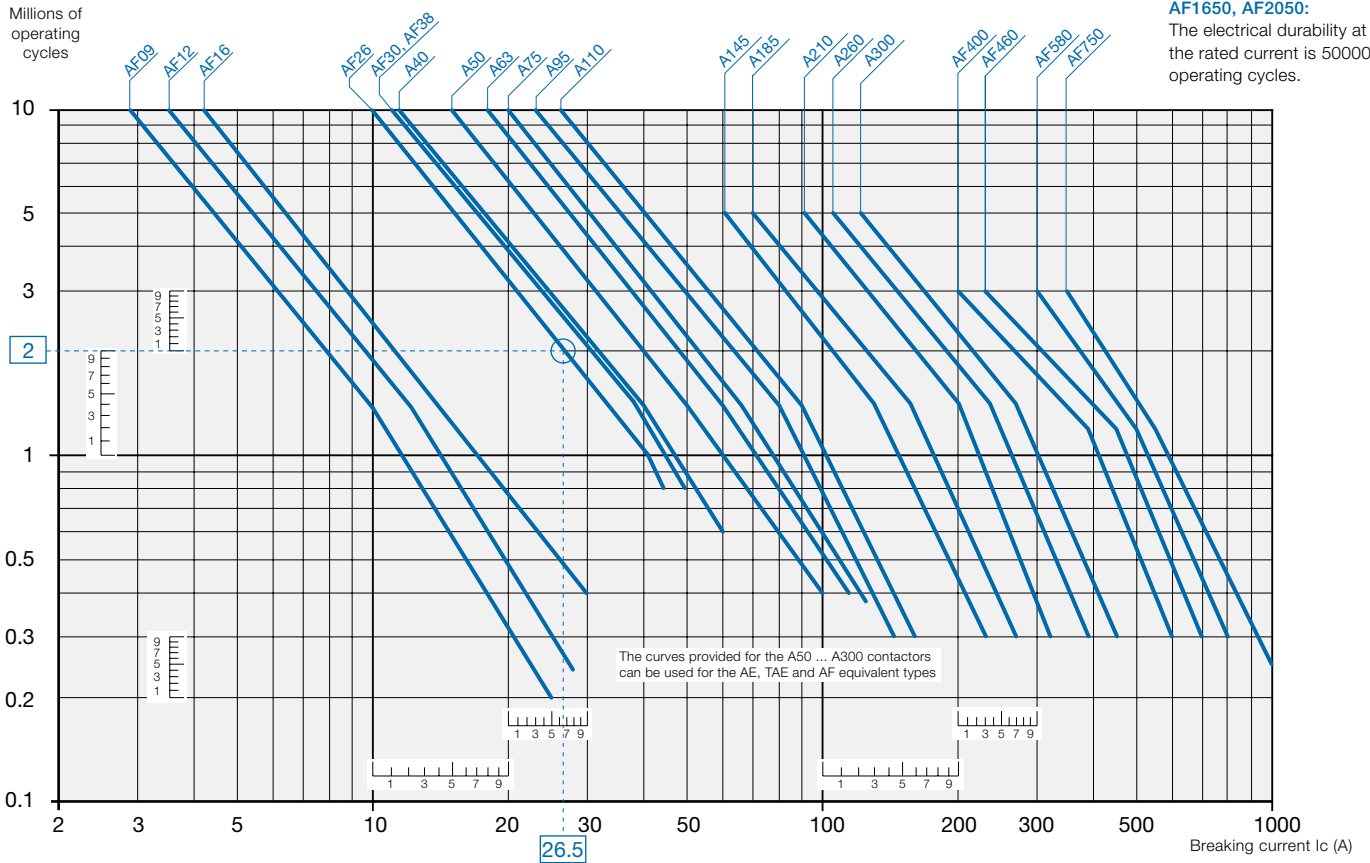

Example:

$I_c / AC-1 = 26.5$ A – Electrical durability required = 2 millions operating cycles.

Using the AC-1 curves above select the AF26 contactor at intersection "O" (26.5 A / 2 millions operating cycles).

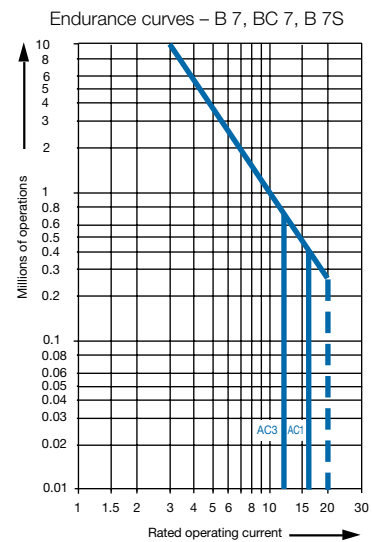
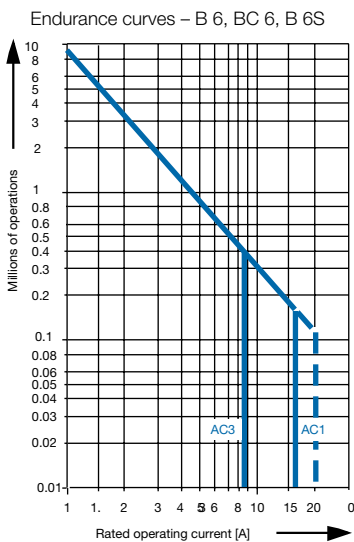

IEC Technical data

3-pole contactors

Electrical durability (AC-3)

Electrical durability for AC-3 utilization category - $U_e \leq 440$ V
 Ambient temperature ≤ 60 °C for AF09(Z)...AF38(Z), ≤ 55 °C for A40 ... AF1650

Switching cage motors: starting and switching off running motors. The breaking current I_c for AC-3 is equal to the rated operational current I_e (I_e = motor full load current). Maximum electrical switching frequency: see "Technical data".

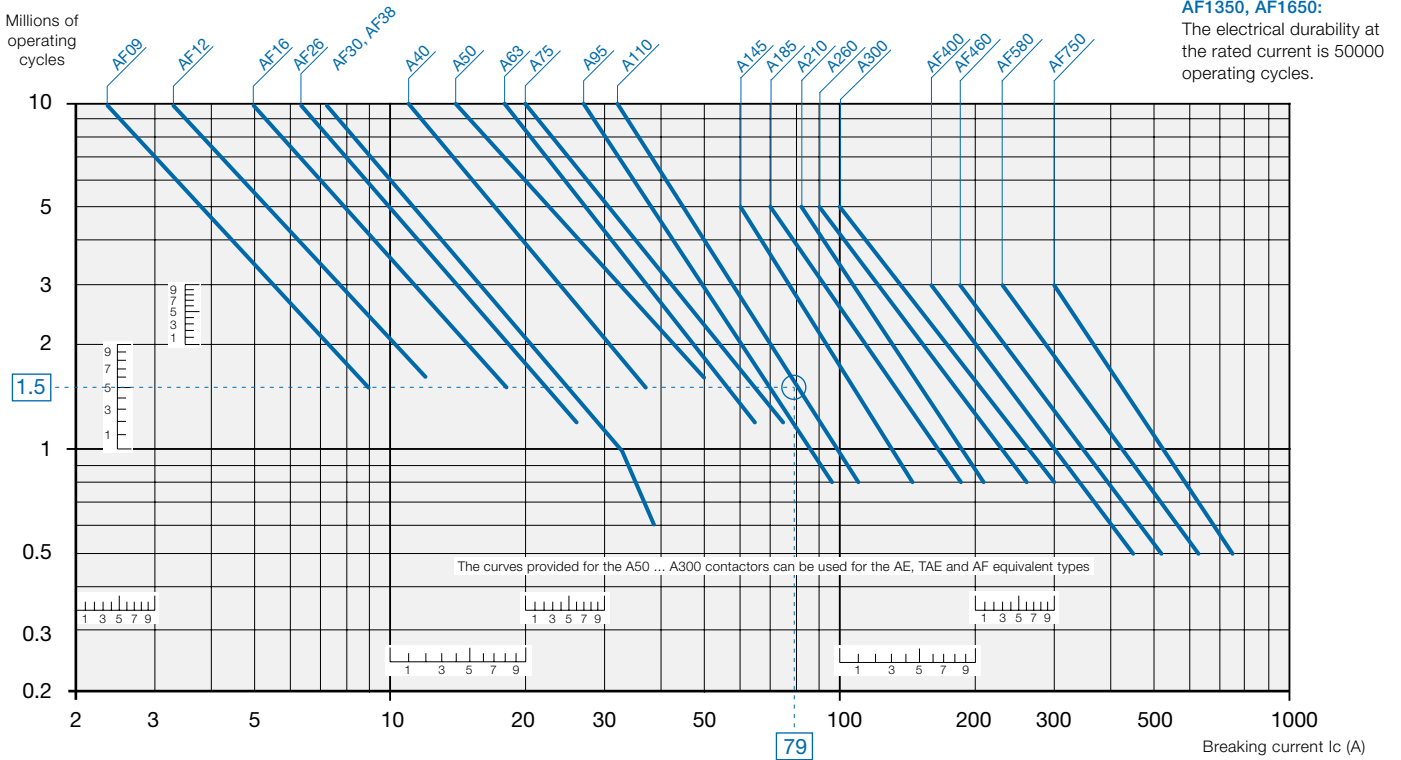

Example:

Motor power 40 kW for AC-3 - $U_e = 400$ V and $I_e = 79$ A utilization – Electrical durability required = 1.5 million operating cycles. For AC-3: $I_c = I_e$. Select the A110 contactor at intersection "O" (79 A / 1.5 million operating cycles) on the curves (AC-3 - $U_e \leq 440$ V).

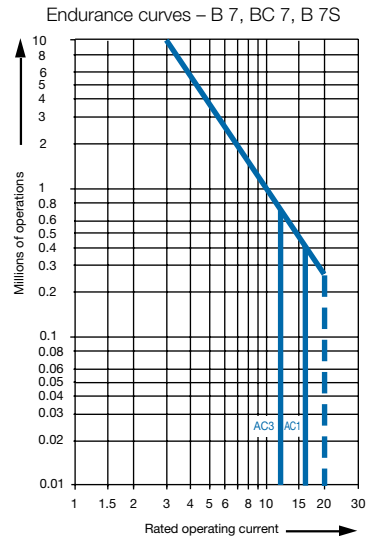
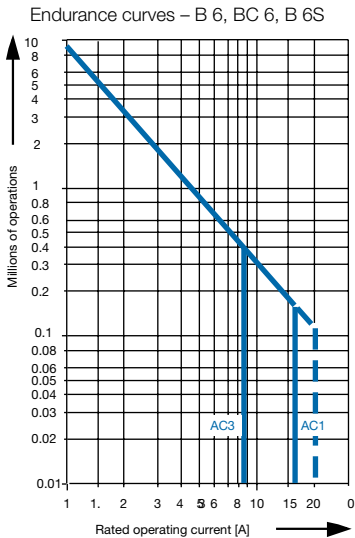

IEC Technical data

3-pole contactors

Electrical durability (AC-2, AC-4)

Electrical durability for AC-2 or AC-4 utilization category - $U_e < 440\text{ V}$
Ambient temperature $\leq 60\text{ }^\circ\text{C}$ for AF09(Z)...AF38(Z), $\leq 55\text{ }^\circ\text{C}$ for A40 ... AF1650

Switching cage motors: starting, reverse operation and step-by-step operation. The breaking current I_c is equal to $2.5 \times I_e$ for AC-2 and $6 \times I_e$ for AC-4, keeping in mind that I_e is the motor rated operational current (I_e = motor full-load current).
 Maximum electrical switching frequency: see "Technical data".

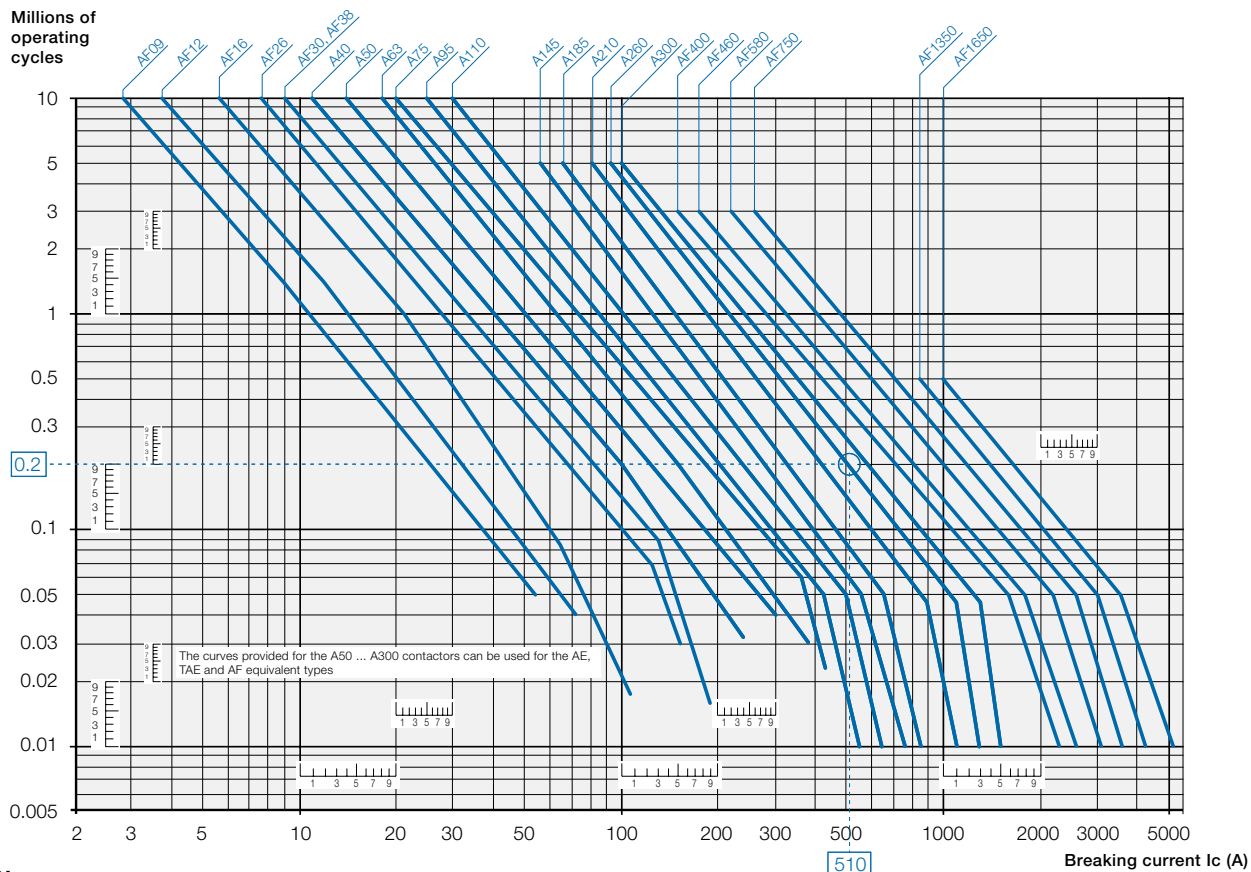

Example:

Motor power 45 kW for AC-4 - $U_e = 400\text{ V}$ and $I_e = 85\text{ A}$ utilization – Electrical durability required = 0.2 million operating cycles.
 For AC-4: $I_c = 6 \times I_e = 510\text{ A}$ - Select the A260 contactor at intersection "O" (510 A / 0.2 million operating cycles) on the curves (AC-4 - $U_e \leq 440\text{ V}$).

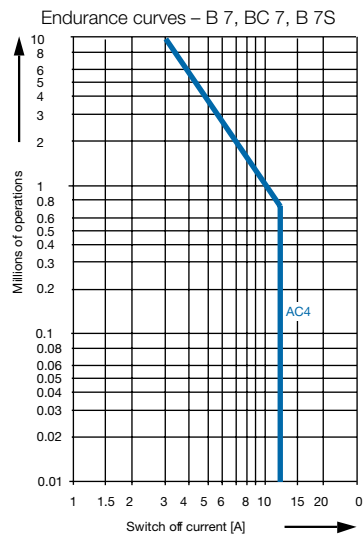
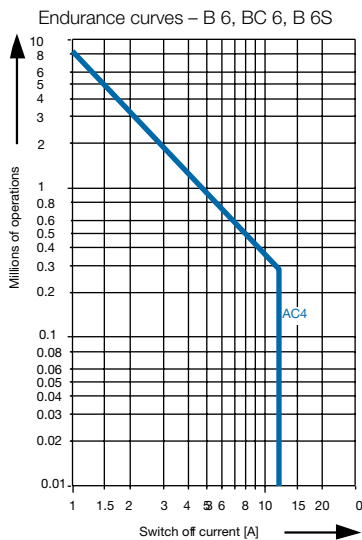

IEC Technical data

4-pole contactors

Electrical durability (AC-1)

Electrical durability for AC-1 utilization category - $U_e \leq 690\text{ V}$
 Ambient temperature $\leq 60\text{ }^\circ\text{C}$ for AF09 ... AF38, $\leq 55\text{ }^\circ\text{C}$ for A45 ... EK1000

Switching non-inductive or slightly inductive loads. The breaking current I_c for AC-1 is equal to the rated operational current of the load.

Maximum electrical switching frequency: see "Technical data".

Example:

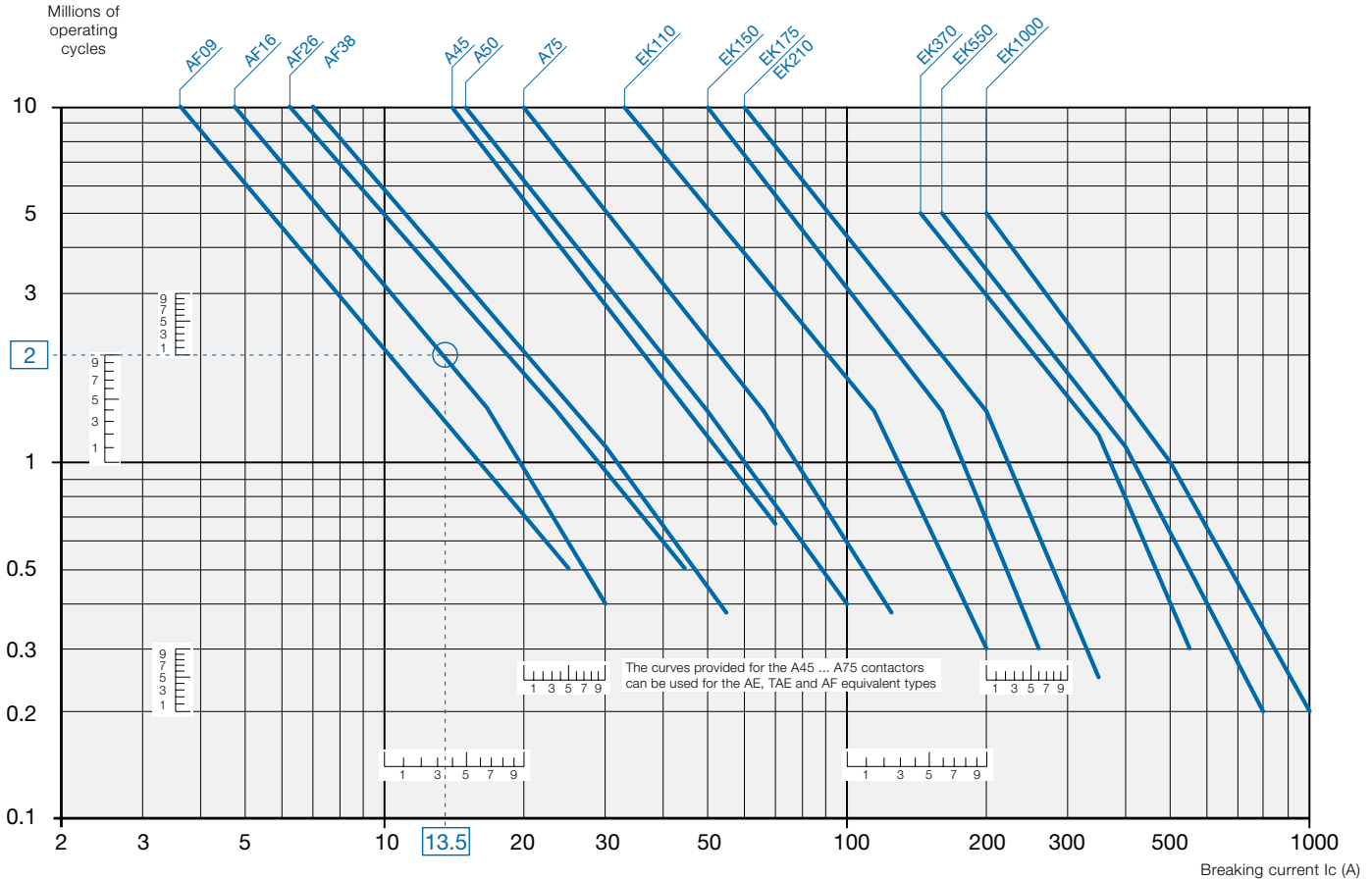

$I_c / \text{AC-1} = 13.5\text{ A}$ – Electrical durability required = 2 millions operating cycles.

Using the AC-1 curves above select the AF16 contactor at intersection "O" (13.5 A / 2 millions operating cycles).

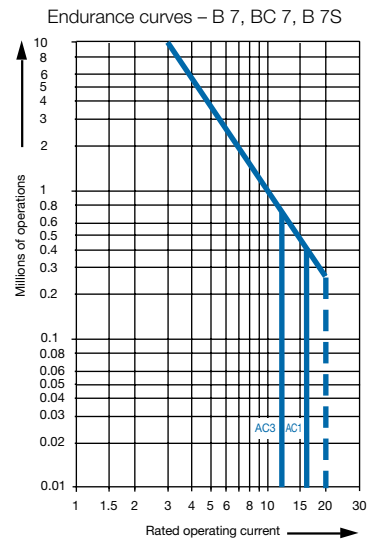
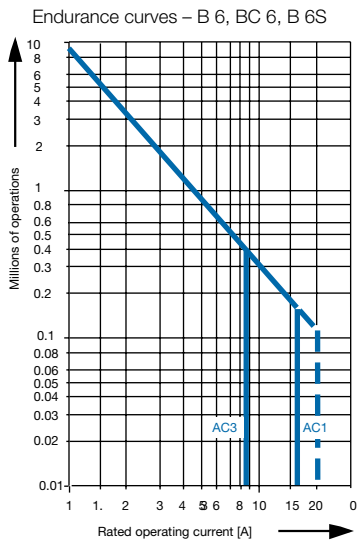

Approximate dimensions

AF09/Z...AF16/Z, AF09N00/Z...AF16N0/Z, 3-pole contactors

Note: Approximate dimensions for AF09 & AF16 apply to AF NEMA Sz. 00 & 0. AF09...AF16 dimensions apply to AF.Z type.

Dimensions mm, inches

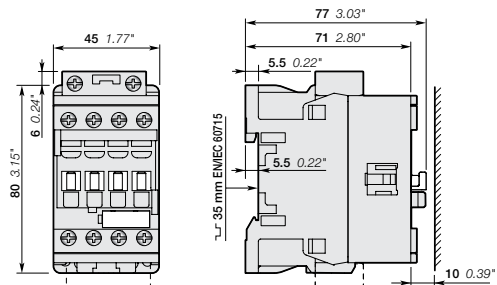

AF09, AF12, AF16

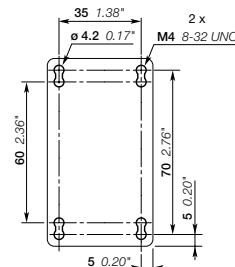

AF09, AF12, AF16

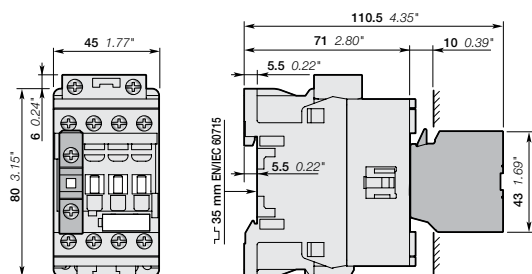

AF09, AF12, AF16
+ CA4, CC4 1-pole auxiliary contact block

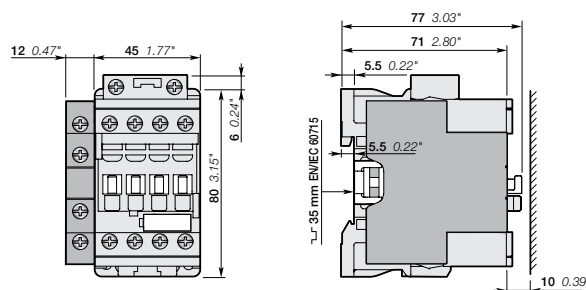

AF09, AF12, AF16
+ CAL4-11 2-pole auxiliary contact block

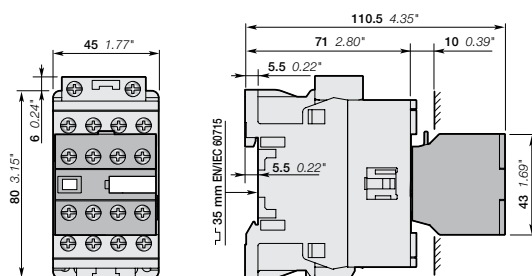

AF09, AF12, AF16
+ CA4 4-pole auxiliary contact block

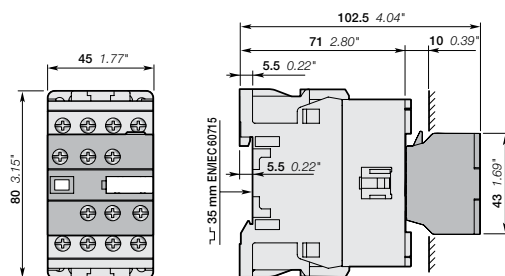

AF09, AF12, AF16
+ CAT4 2-pole auxiliary contact and coil terminal block

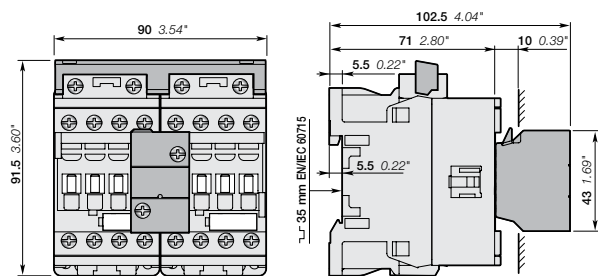

AF09, AF12, AF16
+ VEM4 mechanical and electrical interlock set

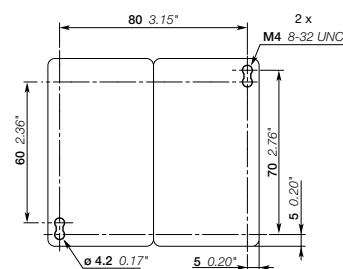

AF09, AF12, AF16
+ VEM4 mechanical and electrical interlock set

Note: contactor lateral distance to grounded component 2 mm 0.08" min.

Approximate dimensions

AF09/Z...AF16/Z, AF09N00/Z...AF16N0/Z, 3-pole contactors

Note: Approximate dimensions for AF26 apply to AF NEMA Sz. 1. AF26...AF38 dimensions apply to AF.Z type.

Dimensions mm, inches

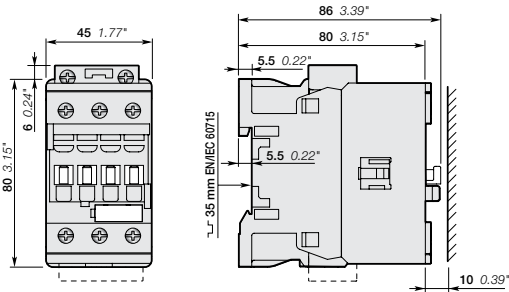

AF26, AF30, AF38

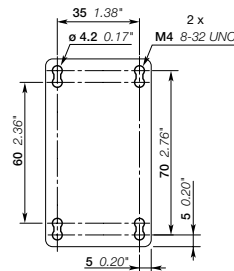

AF26, AF30, AF38

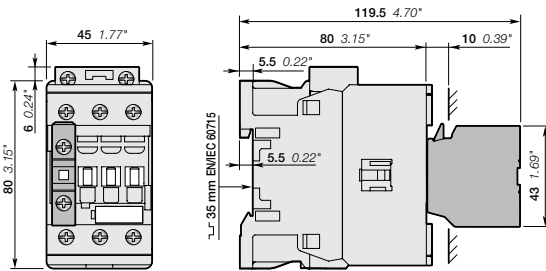

AF26, AF30, AF38
+ CA4, CC4 1-pole auxiliary contact block

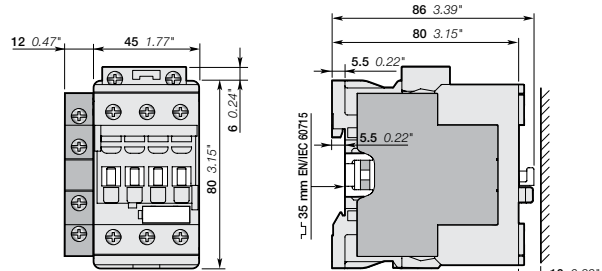

AF26, AF30, AF38
+ CAL4-11 2-pole auxiliary contact block

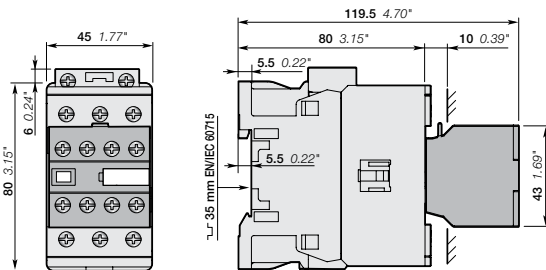

AF26, AF30, AF38
+ CA4 4-pole auxiliary contact block

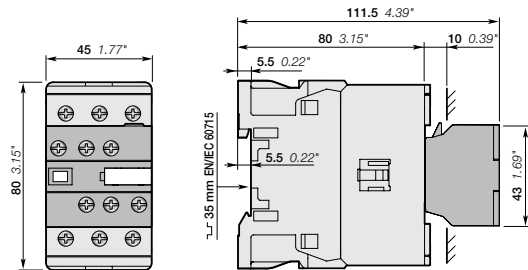

AF26, AF30, AF38
+ CAT4 2-pole auxiliary contact and coil terminal block

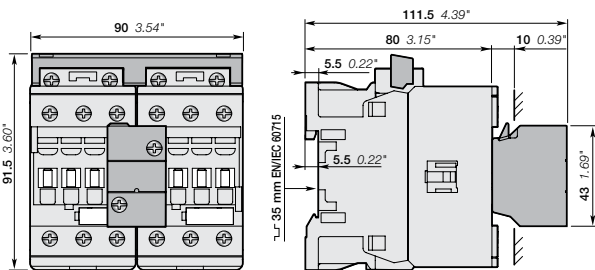

AF26, AF30, AF38
+ VEM4 mechanical and electrical interlock set

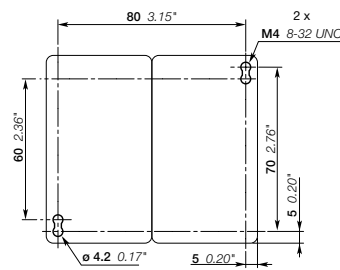

AF26, AF30, AF38
+ VEM4 mechanical and electrical interlock set

Note: contactor lateral distance to grounded component 2 mm 0.08" min.

Approximate dimensions

AF09/Z & AF16/Z 4-pole contactors

Note: AF09 & AF16 dimensions apply to AF..Z type.

Dimensions mm, inches

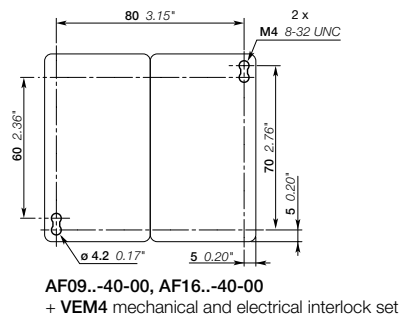
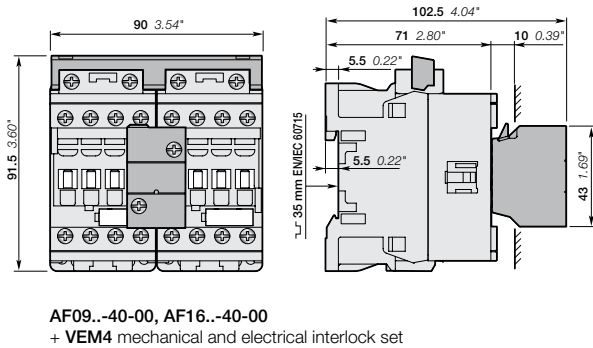
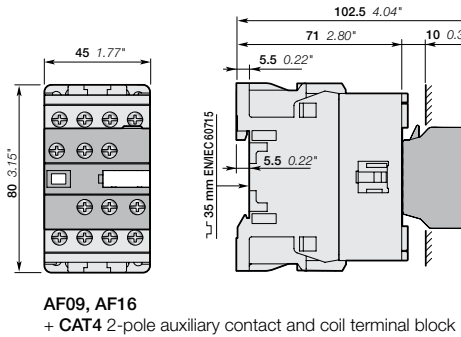
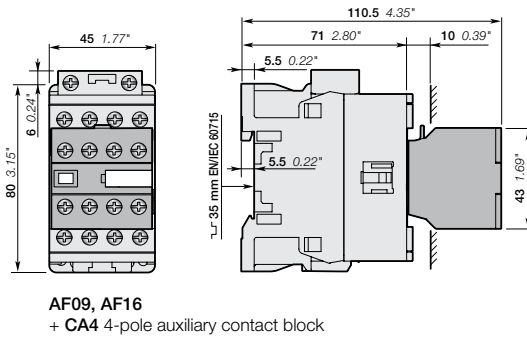
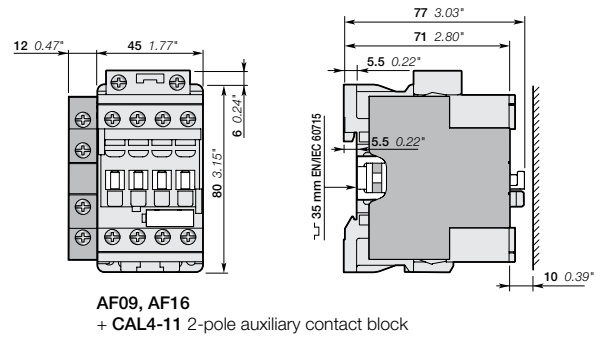
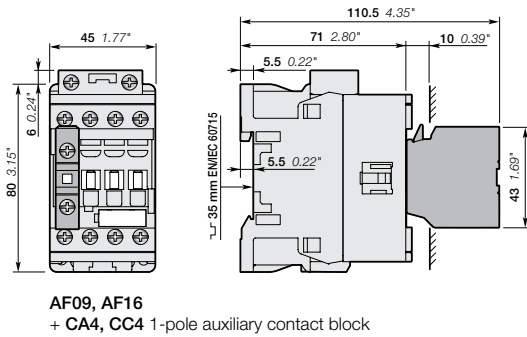
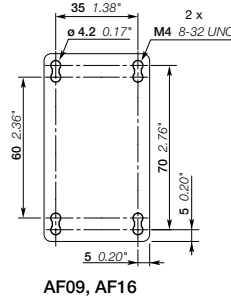
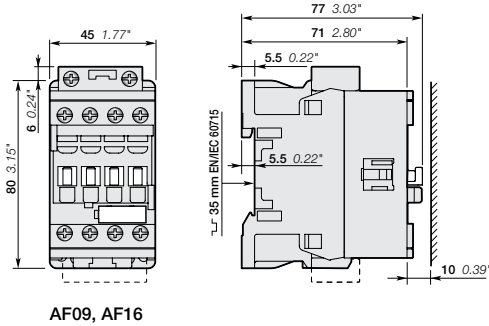

Note: contactor lateral distance to grounded component 2 mm 0.08" min.

Approximate dimensions AF26/Z & AF38/Z 4-pole contactors

Note: AF26 & AF38 dimensions apply to AF..Z type.

Dimensions mm, inches

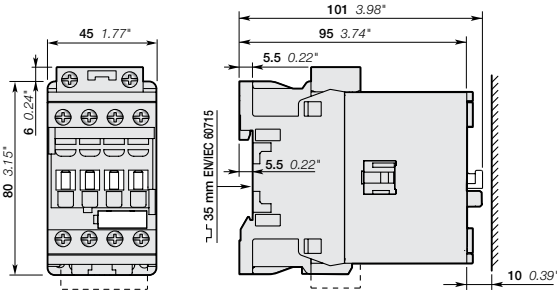

AF26, AF38

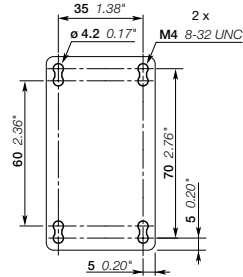

AF26, AF38

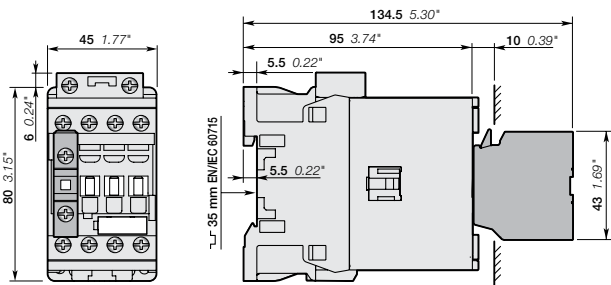

AF26, AF38
+ CA4, CC4 1-pole auxiliary contact block

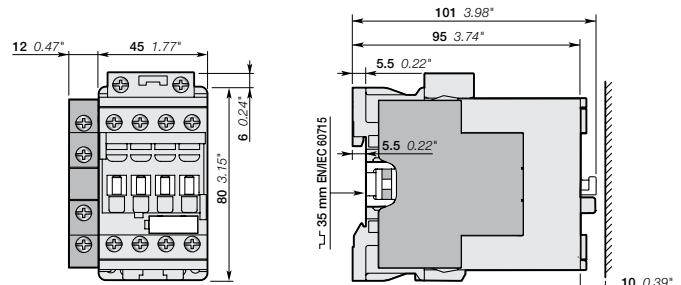

AF26, AF38
+ CAL4-11 2-pole auxiliary contact block

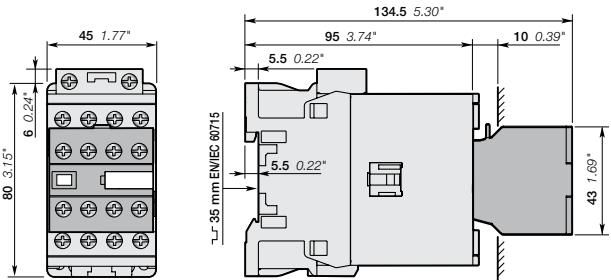

AF26, AF38
+ CA4 4-pole auxiliary contact block

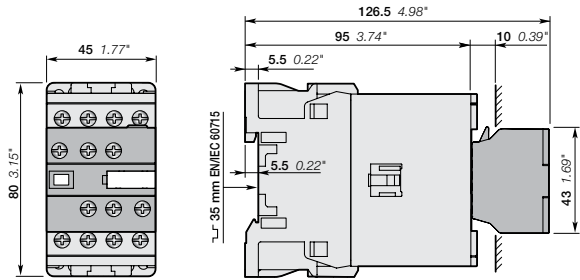

AF26, AF38
+ CAT4 2-pole auxiliary contact and coil terminal block

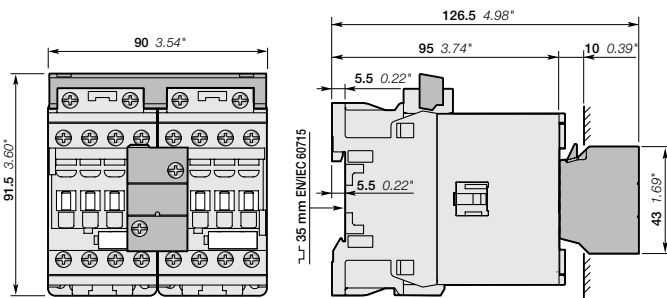

AF26..-40-00, AF38..-40-00
+ VEM4 mechanical and electrical interlock set

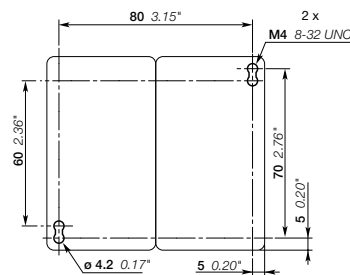

AF26..-40-00, AF38..-40-00
+ VEM4 mechanical and electrical interlock set

Note: contactor lateral distance to grounded component 2 mm 0.08 inches min.

Approximate dimensions

AS09..S ... AS16..S 3-pole contactors w/spring terminals
AC/DC operated, with screw terminals

Main dimensions mm, inches

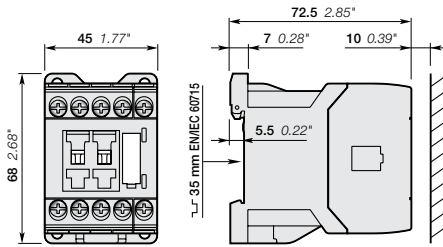

AS/L09, AS/L12, AS/L16

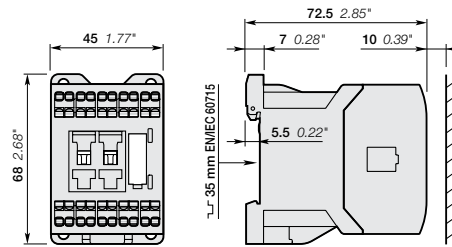

AS/L09..S, AS/L12..S, AS/L16..S

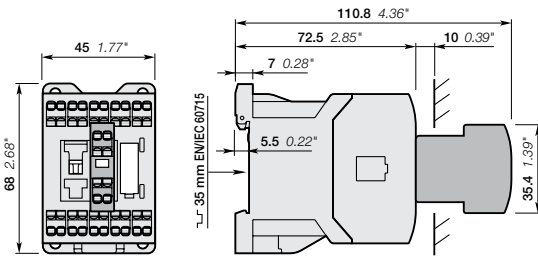
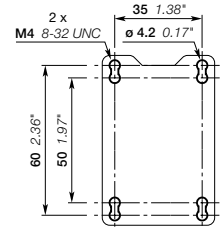

AS/L09..S, AS/L12..S, AS/L16..S
+ CA3..S front-mounted 1-pole auxiliary contact block

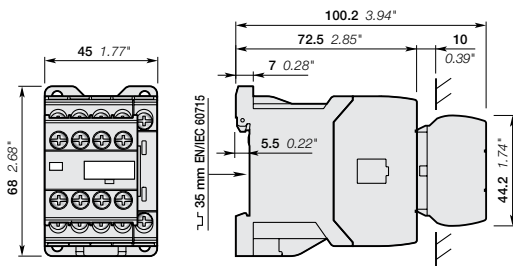

AS/L09...16-30-32

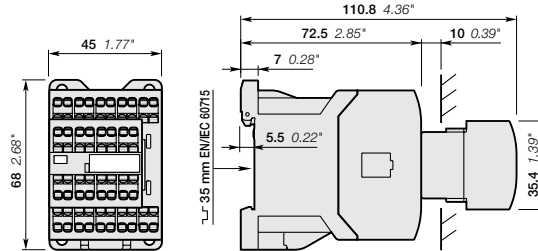

AS/L09...16-30-32S

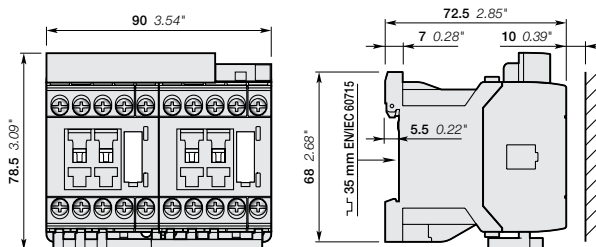

AS/L09, AS/L12, AS/L16

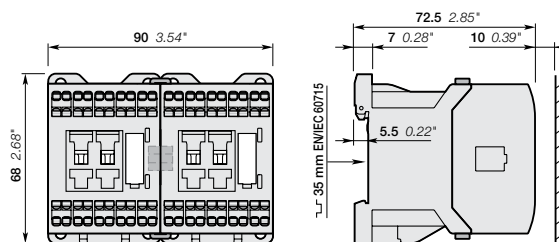

AS/L09..S, AS/L12..S, AS/L16..S
+ VM3 mechanical interlock unit including two BB3 fixing clips

Approximate dimensions B/C6...B/C7

00.00 → Inches
00.00 → [Millimeters]

VB/C6...VB/C7

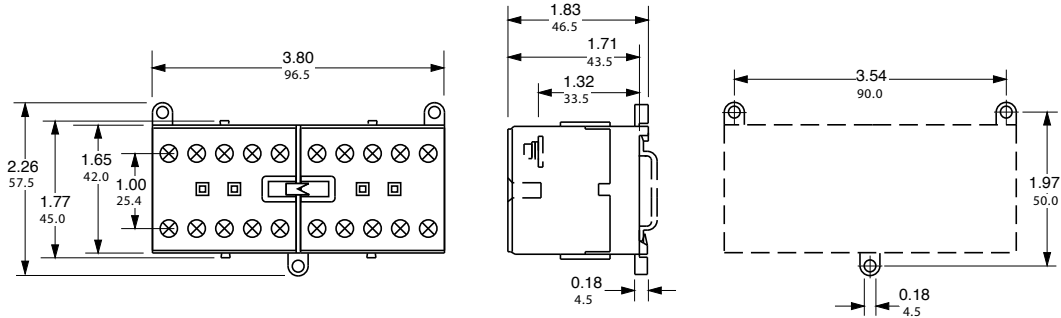

B/C6...B/C7

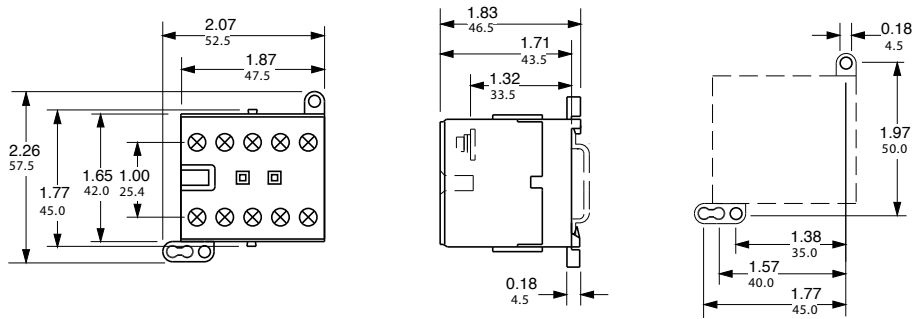

B/C6...B/C7 + CA6

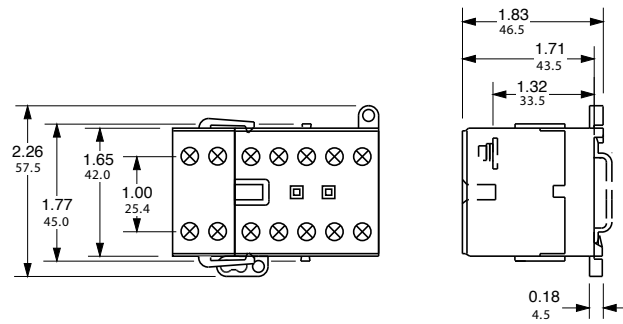

B/C6...B/C7 + CAF6

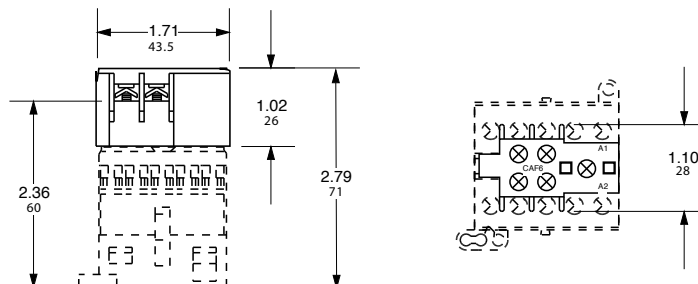

Approximate dimensions A/AE9 – A/AE26, 3 pole

00.00 Inches
00.00 [Millimeters]

A/AE9 – A/AE16 – Contactor, 3 pole

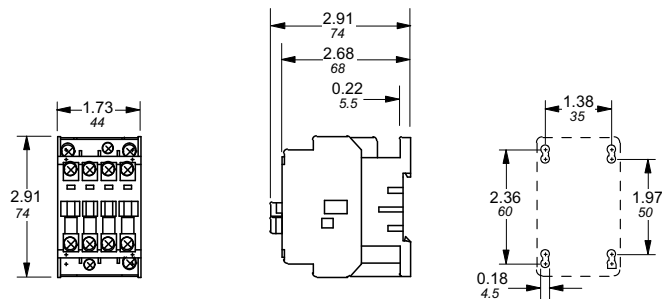

A/AE9 – A/AE16 + VM5 or VE5 – Mechanically interlocked contactor, 3 pole

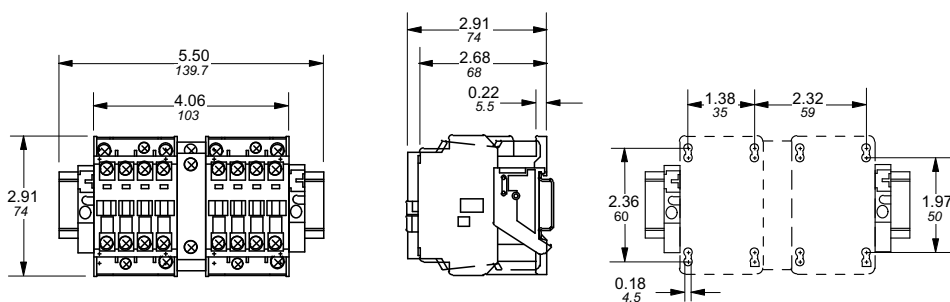

A/AE26 – Contactor, 3 pole

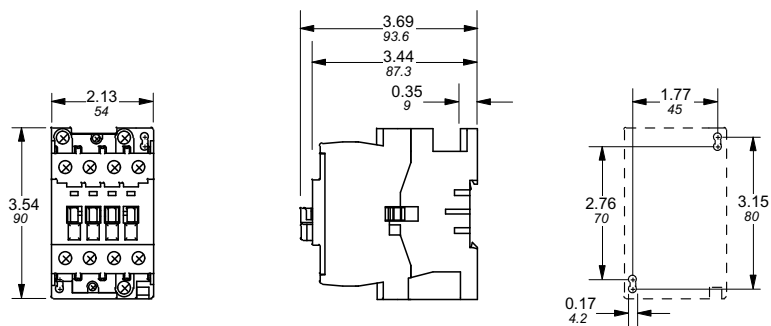

A/AE26 + VM5 or VE5 – Mechanically interlocked contactor, 3 pole

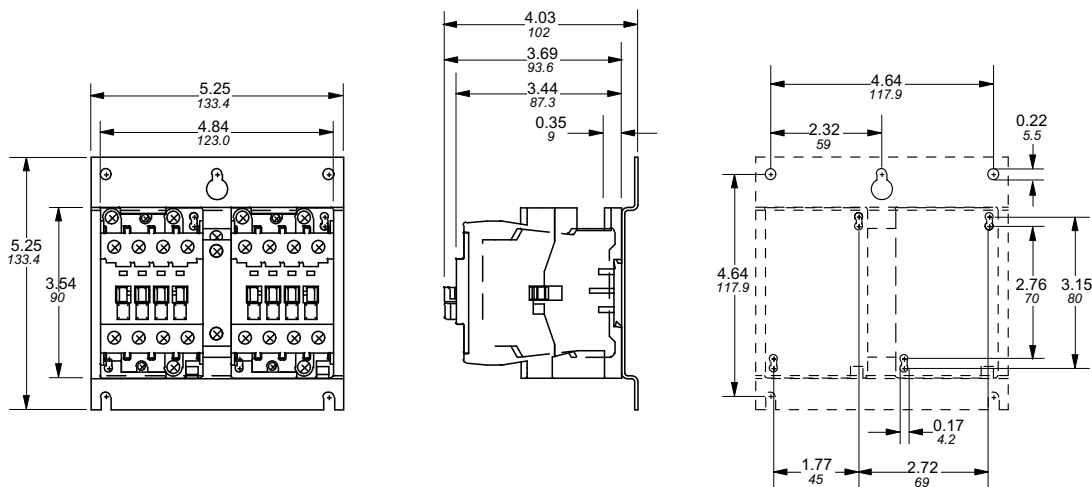

Approximate dimensions A/AE30 – A/AE/AF75, 3 pole

00.00 Inches
00.00 [Millimeters]

A/AE30 & A/AE40 – Contactor, 3 pole

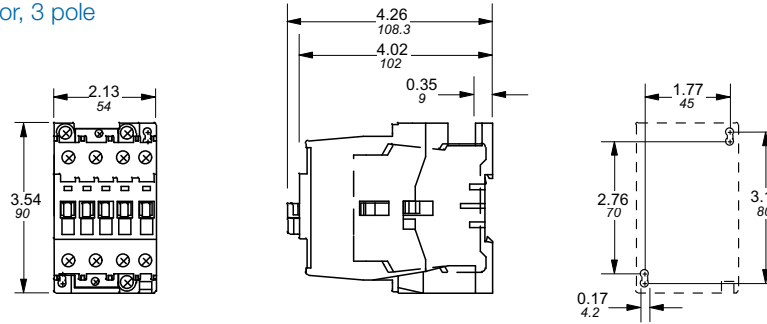

A/AE30 & A/AE40 + VM5 or VE5 – Mechanically interlocked contactor, 3 pole

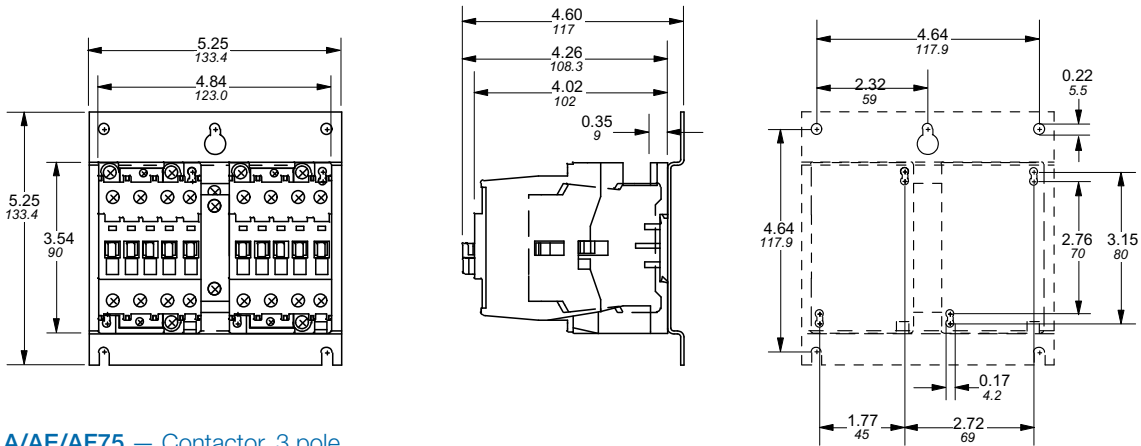

A/AE/AF50 – A/AE/AF75 – Contactor, 3 pole

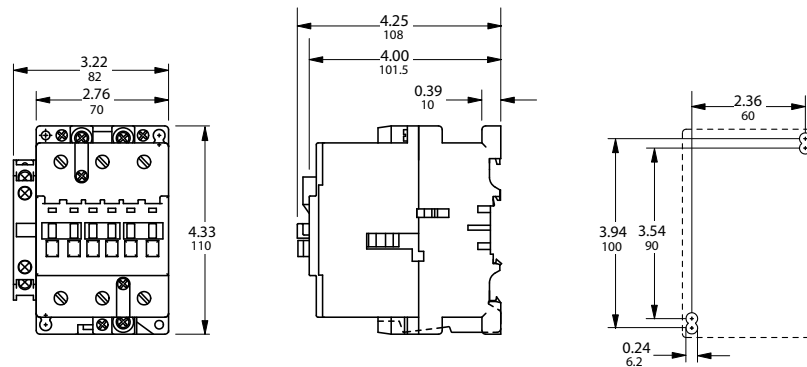

A/AE/AF50 – A/AE/AF75 + VM5 or VE5 – Mechanically interlocked contactor, 3 pole

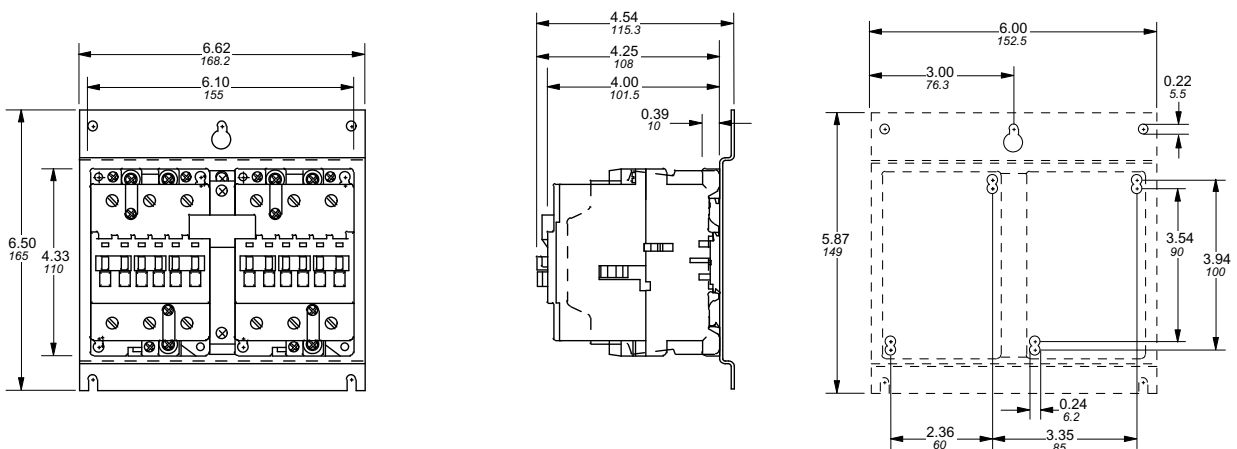

Approximate dimensions A/AE/AF95 & A/AE/AF110, 3 pole

00.00 Inches
00.00 [Millimeters]

A/AE/AF95 & A/AE/AF110 — Contactor, 3 pole

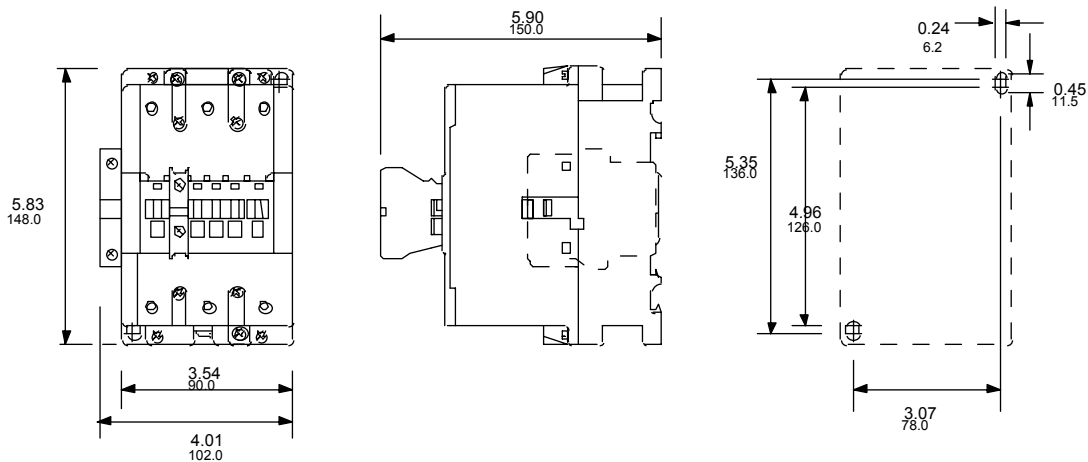

A/AE/AF95 & A/AE/AF110 + VE5 — Mechanically interlocked contactor, 3 pole

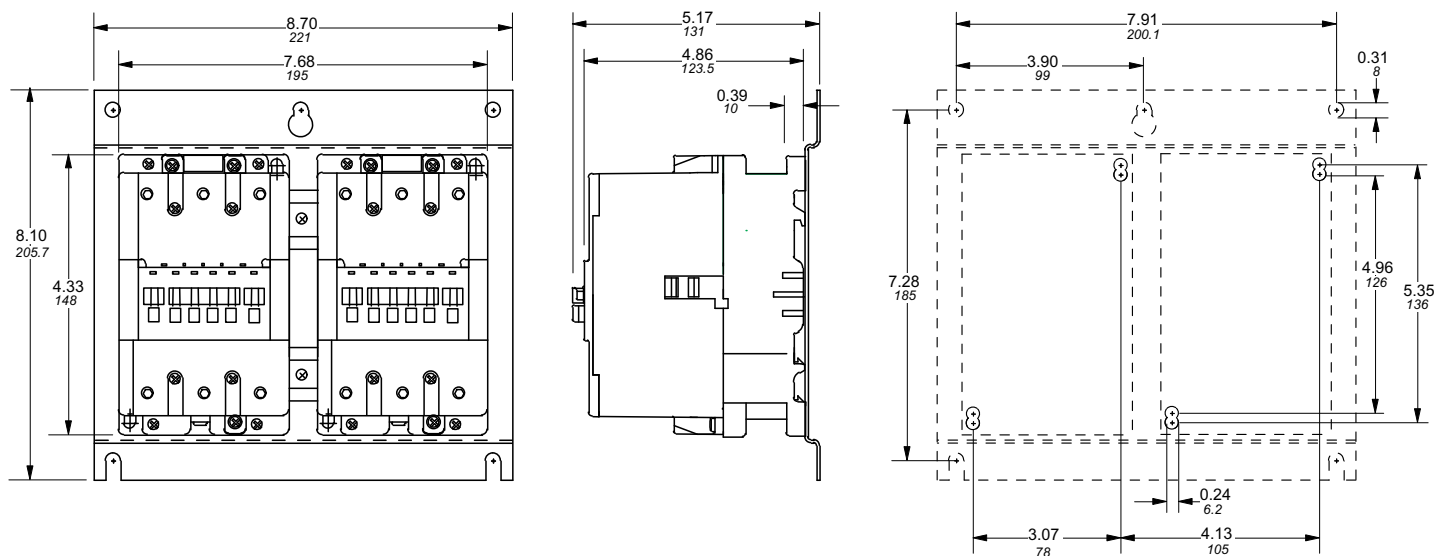

Approximate dimensions A/AE9 – A/AE/AF75, 4 pole

00.00 Inches
00.00 [Millimeters]

A/AE9 – A/AE16 — Contactor, 4 pole

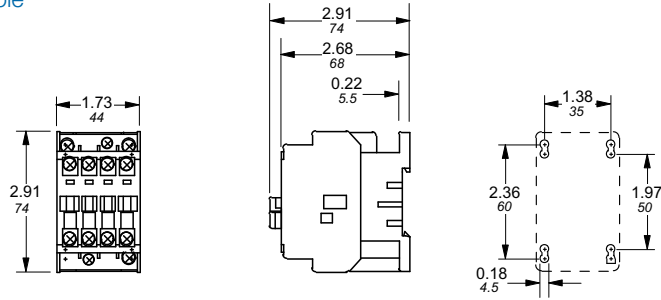

A/AE26 — Contactor, 4 pole

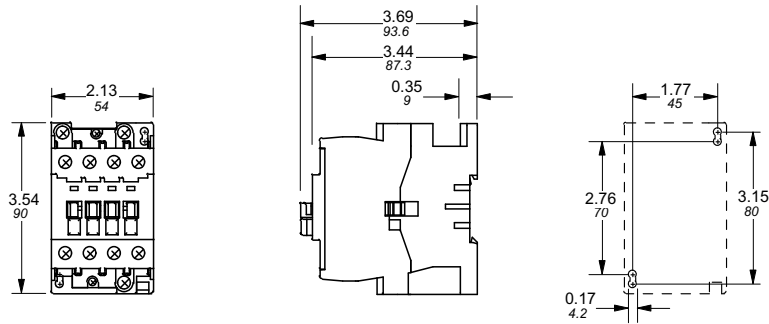

A/AE/AF45 – A/AE/AF75 — Contactor, 4 pole

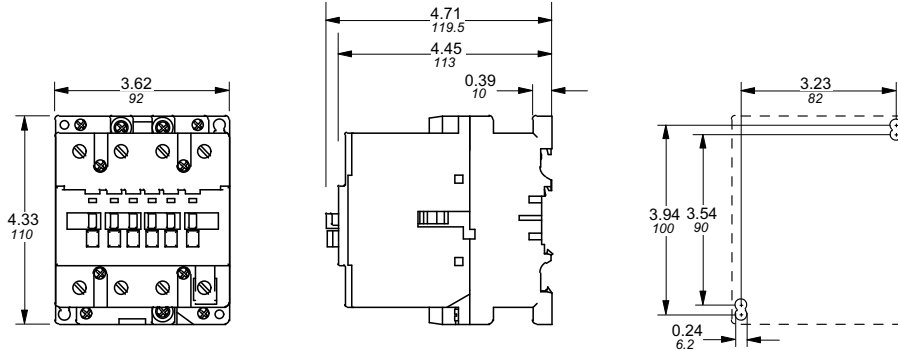

Approximate dimensions AL9 – AL40, 3 & 4 pole

00.00 Inches
00.00 [Millimeters]

AL9, AL12., AL16 — Contactor, 3 & 4 pole

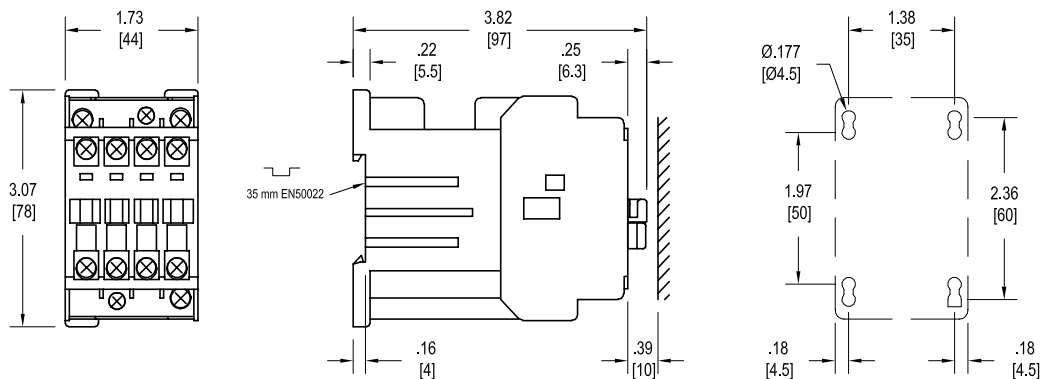

AL26 — Contactor, 3 & 4 pole

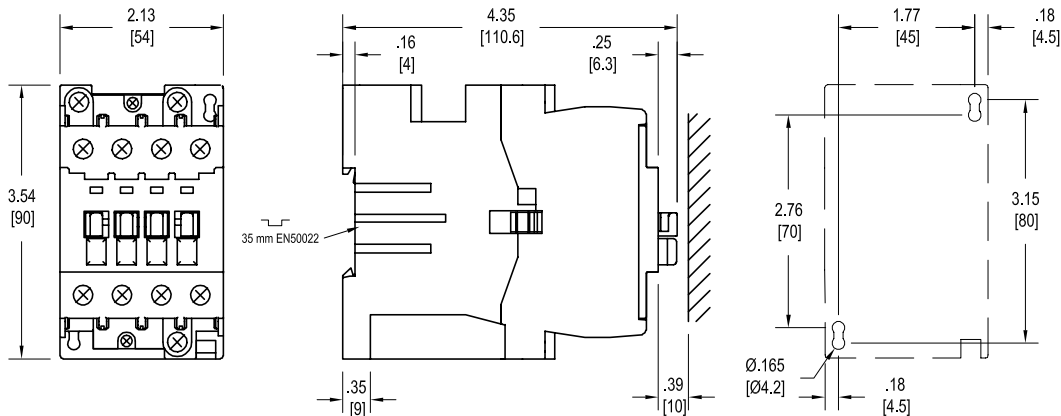

AL30, AL40 — Contactor, 3 pole

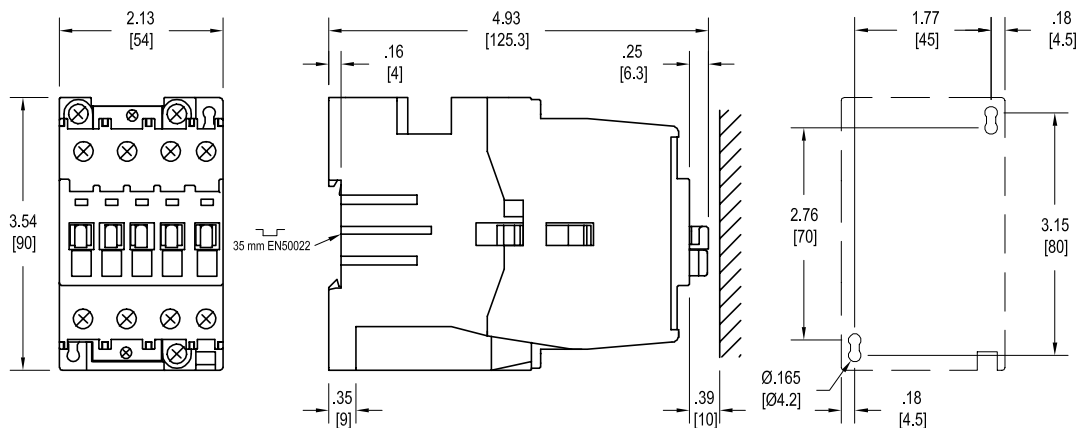

Approximate dimensions Accessories for A/AE9 – A/AE/AF110

00.00 Inches
00.00 [Millimeters]

A/AE9 – A/AE40
A/AE/AF50 – A/AE/AF110

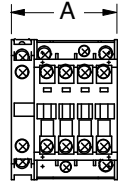

SIDE MOUNTED
AUXILIARY

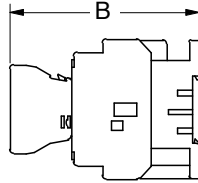

SINGLE POLE
TOP MOUNTED
AUXILIARY

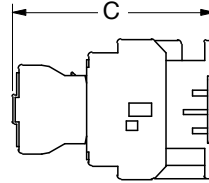

FOUR POLE
TOP MOUNTED
AUXILIARY

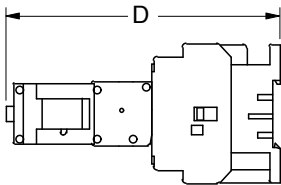

ON-POSITION
LATCH

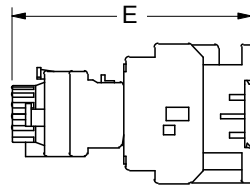

PNEUMATIC
TIMER

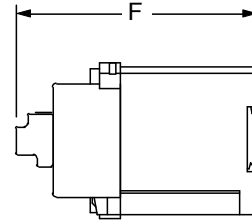

MECH INTERLOCK D.C.
OPERATED

TYPE		A	B	C	D	E	F
A/AE9-16	IN	2.20	3.96	4.21	5.71	5.00	–
	MM	56	100.5	107	145	127	–
A/AE26	IN	2.20	4.72	4.97	6.47	5.76	–
	MM	56	119.8	126.3	164.3	146.3	–
A/AE30-40	IN	2.20	5.30	5.55	7.05	6.34	–
	MM	56	134.5	141	179	161	–
A/AE/AF50-75	IN	3.23	5.27	5.52	7.03	6.32	–
	MM	82	133.9	140.3	178.5	160.4	–
A/AE/AF45	IN	4.09	5.73	5.98	7.48	6.77	–
	MM	104	145.5	152	190	172	–
A/AE/AF95-110	IN	4.02	5.91	6.16	–	–	–
	MM	102	150	156.5	–	–	–

Approximate dimensions A/AF145 – A/AF185

00.00 Inches
00.00 [Millimeters]

A/AF145 & A/AF185

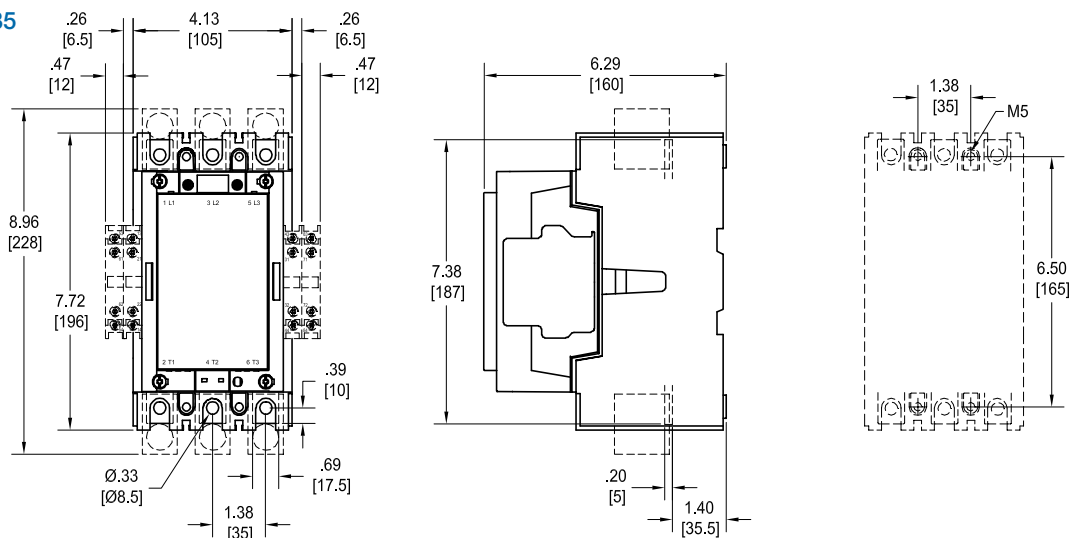

A/AF145, A/AF185 with mechanical interlock

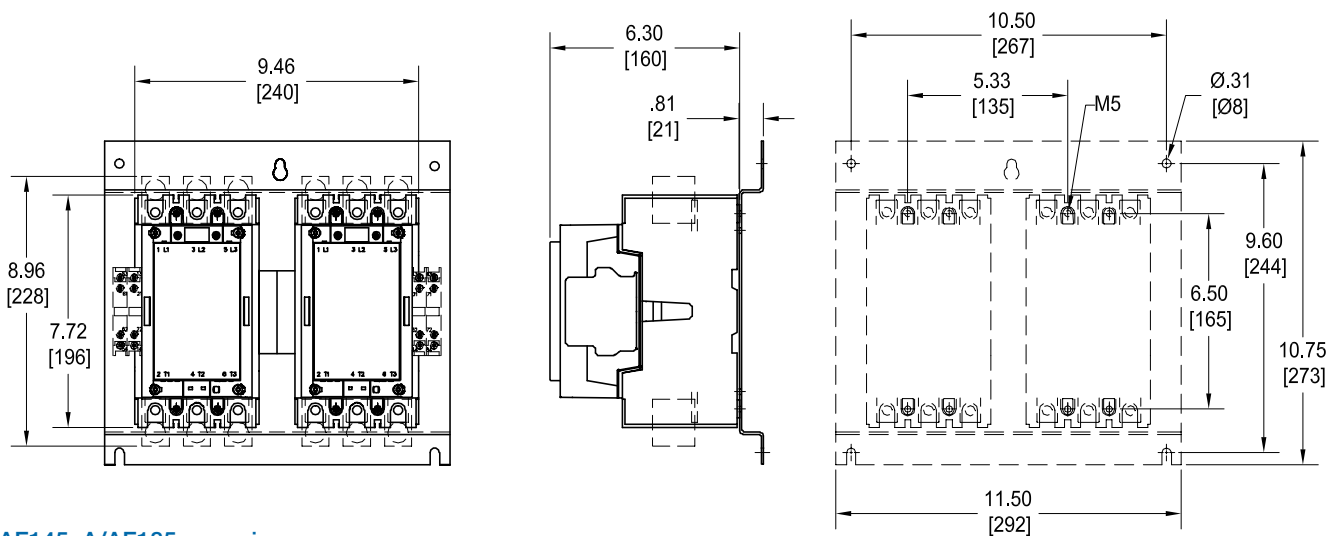

A/AF145, A/AF185 reversing

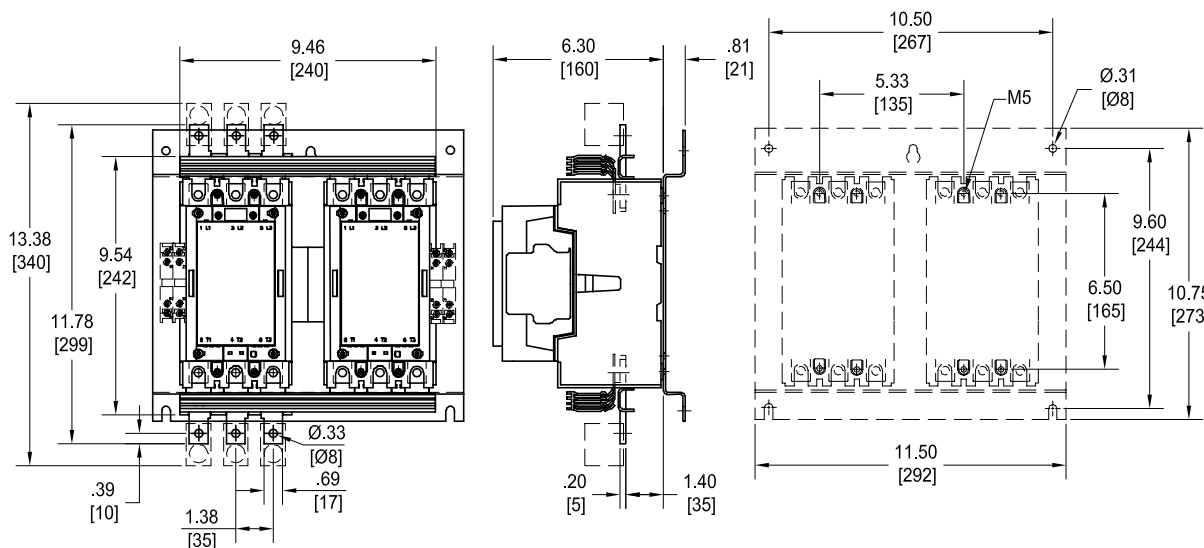

Approximate dimensions A/AF145 – A/AF300

00.00 Inches
00.00 [Millimeters]

A/AF145 – A/AE/AF95-110 mechanically interlocked

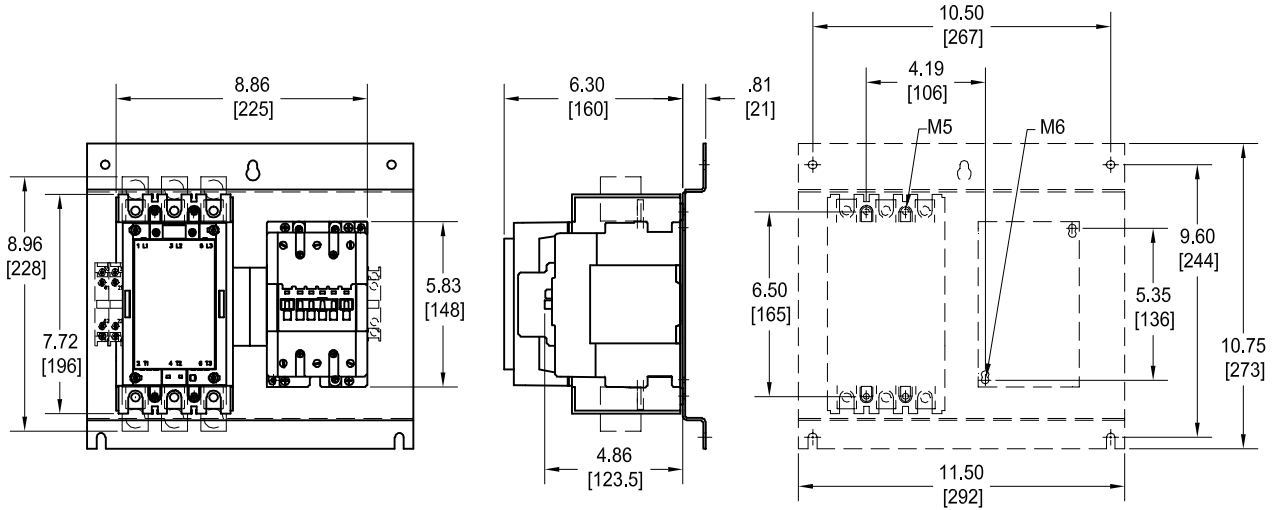

A/AF210, A/AF260, A/AF300

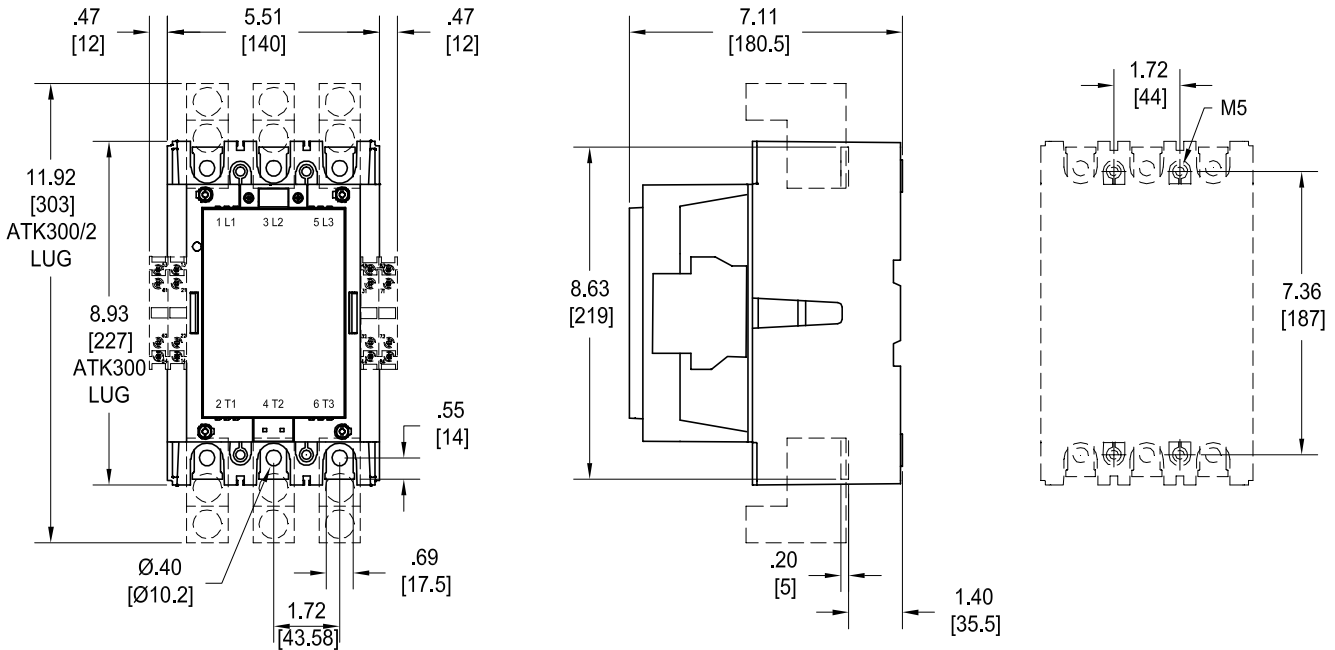

Approximate dimensions A/AF210 – A/AF300

00.00 Inches
00.00 [Millimeters]

A/AF210, A/AF260, A/AF300 with mechanical interlock

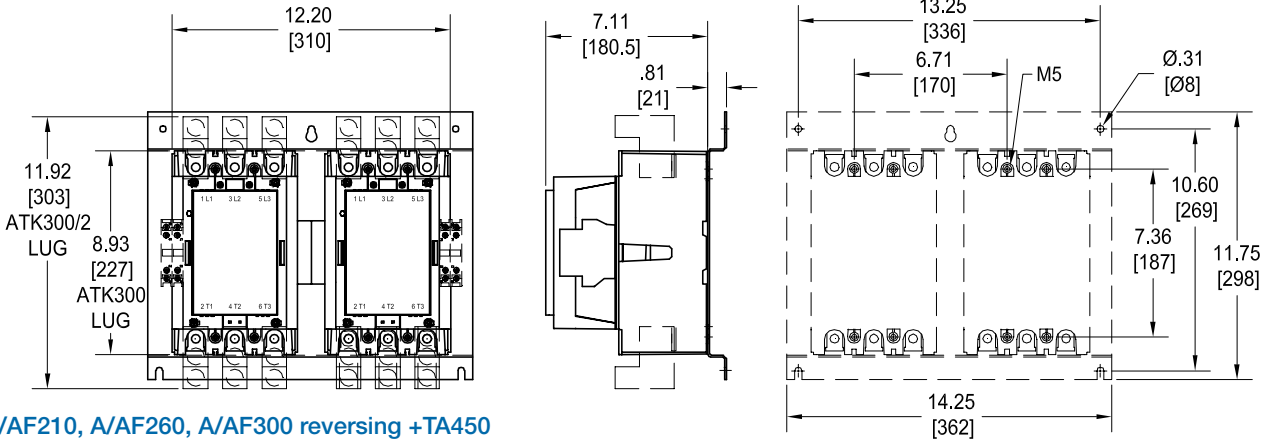

A/AF210, A/AF260, A/AF300 reversing +TA450

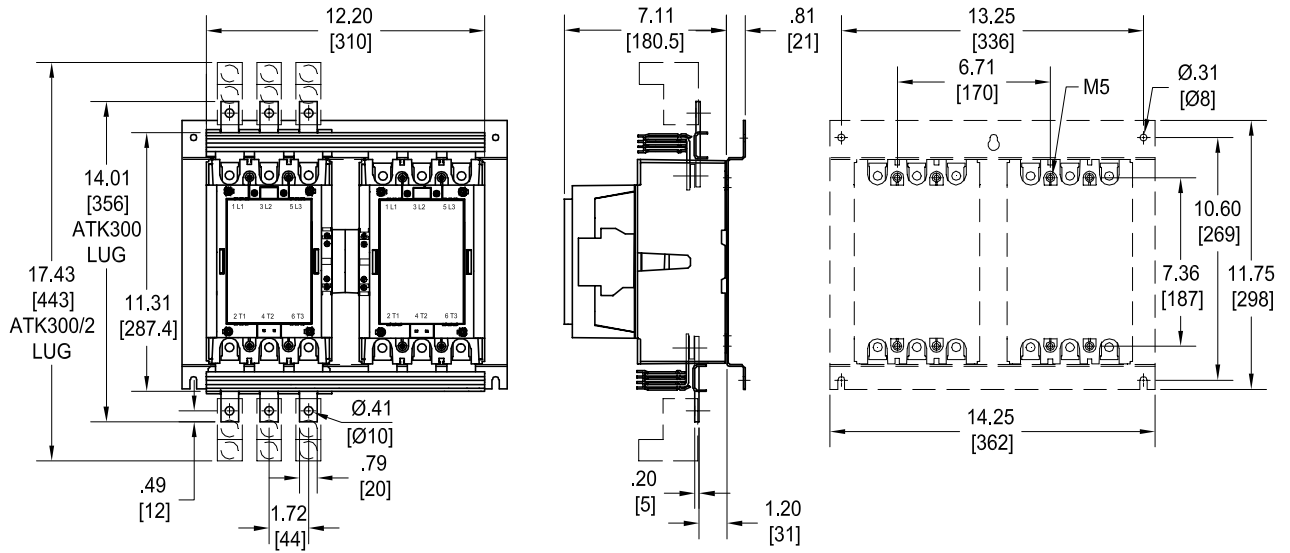

A/AF210, A/AF145 with mechanical interlock

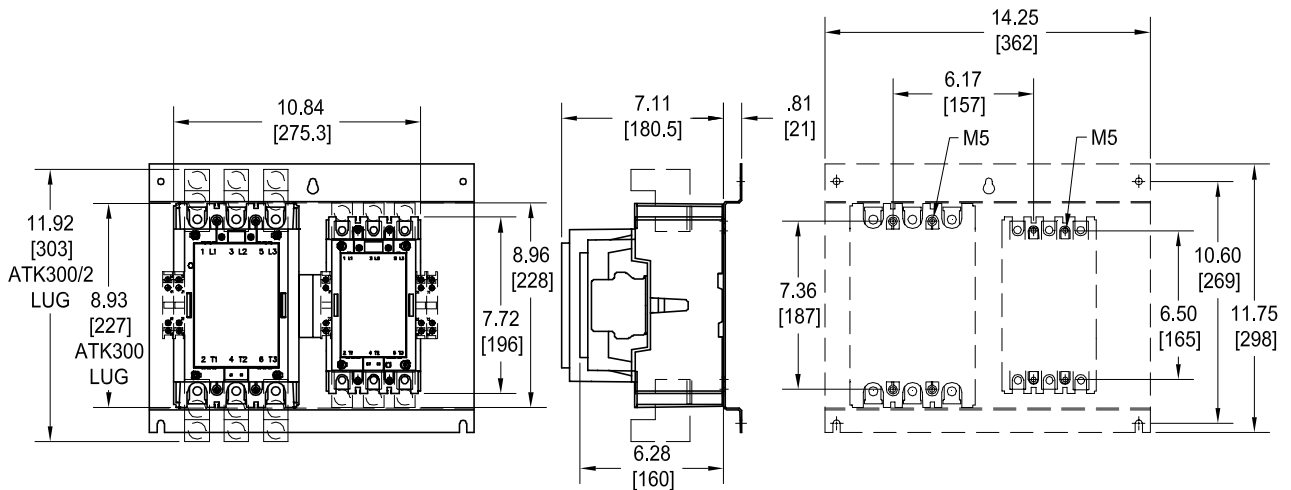

Approximate dimensions AF400 – AF460

00.00 Inches
00.00 [Millimeters]

AF400, AF460

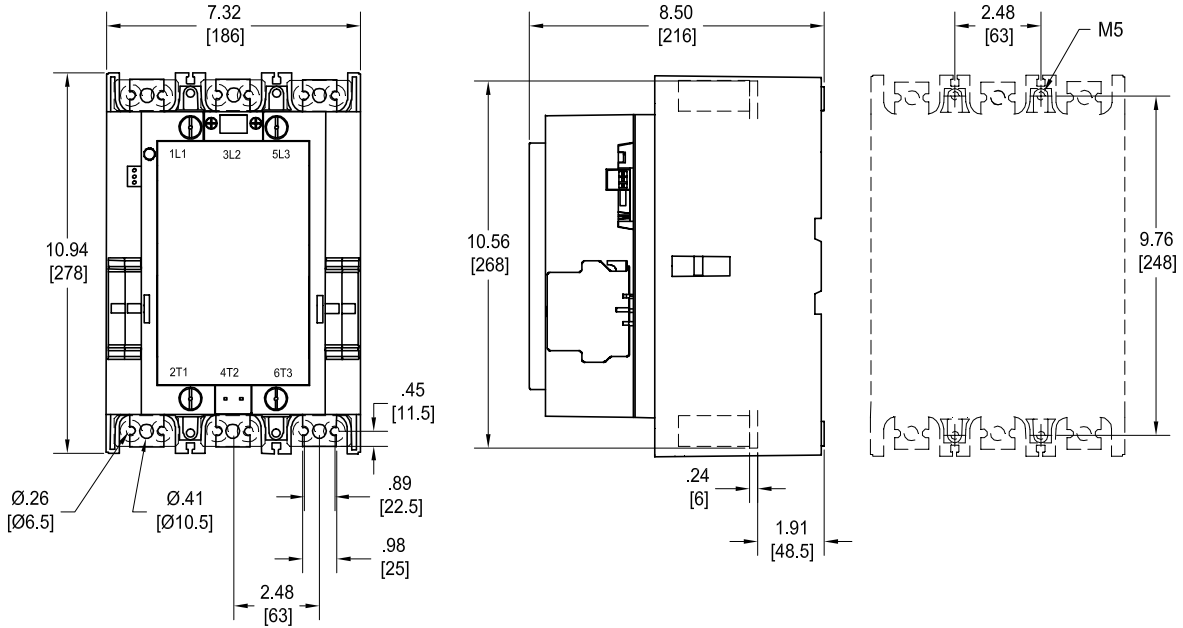

AF400, AF460 with mechanical interlock

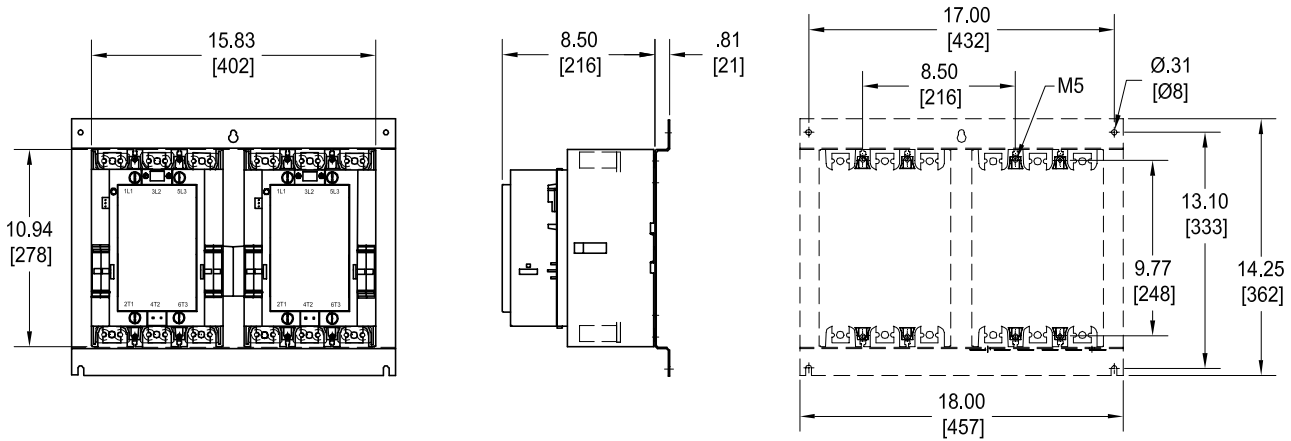

Approximate dimensions AF400 – AF750

00.00 Inches
00.00 [Millimeters]

AF400, AF460 reversing

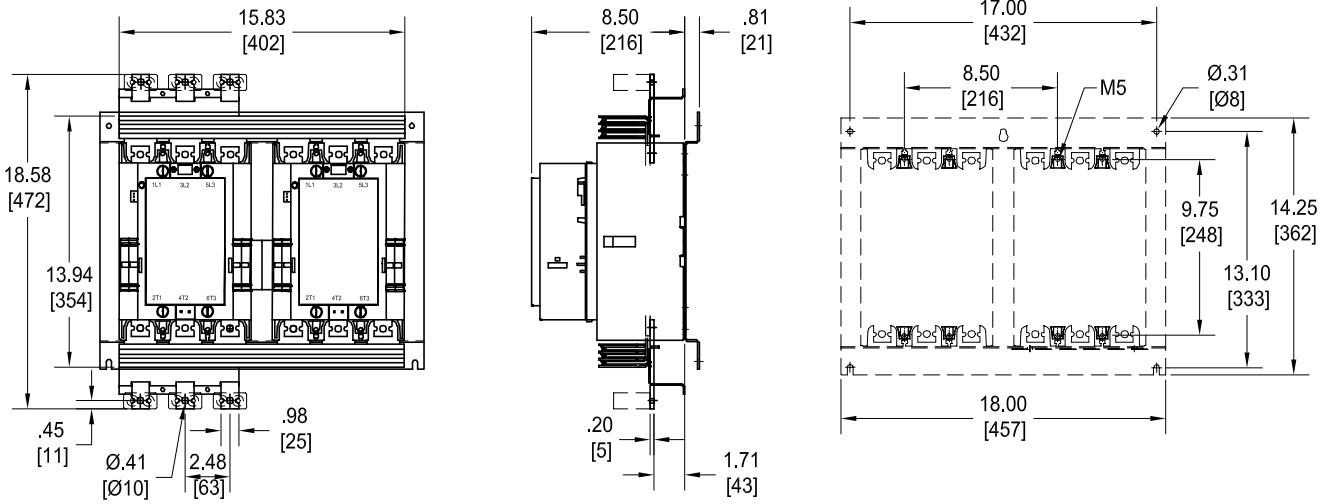

AF580 – AF750

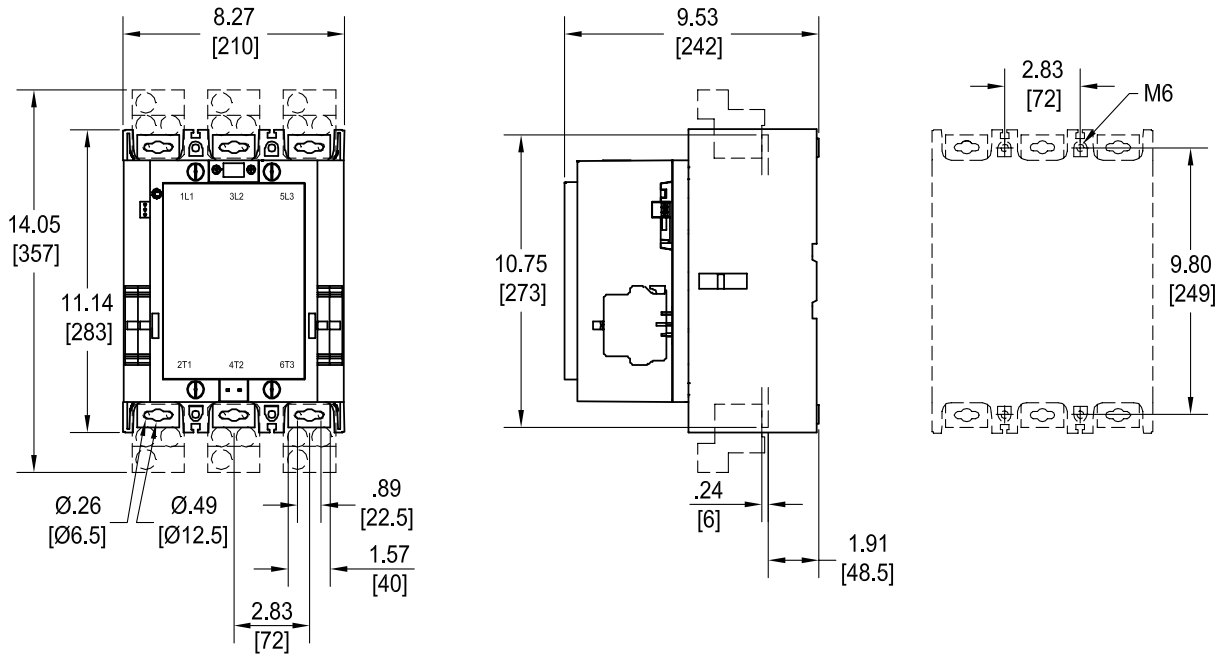

Approximate dimensions AF580 – AF750

00.00 Inches
00.00 [Millimeters]

AF580 – AF750 with mechanical interlock

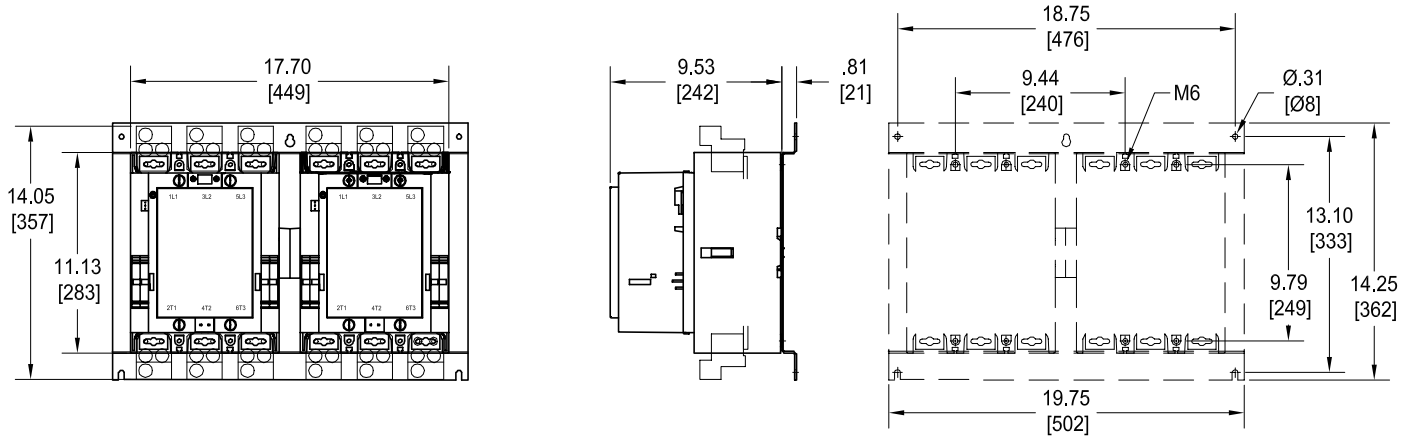

AF580 – AF750 reversing

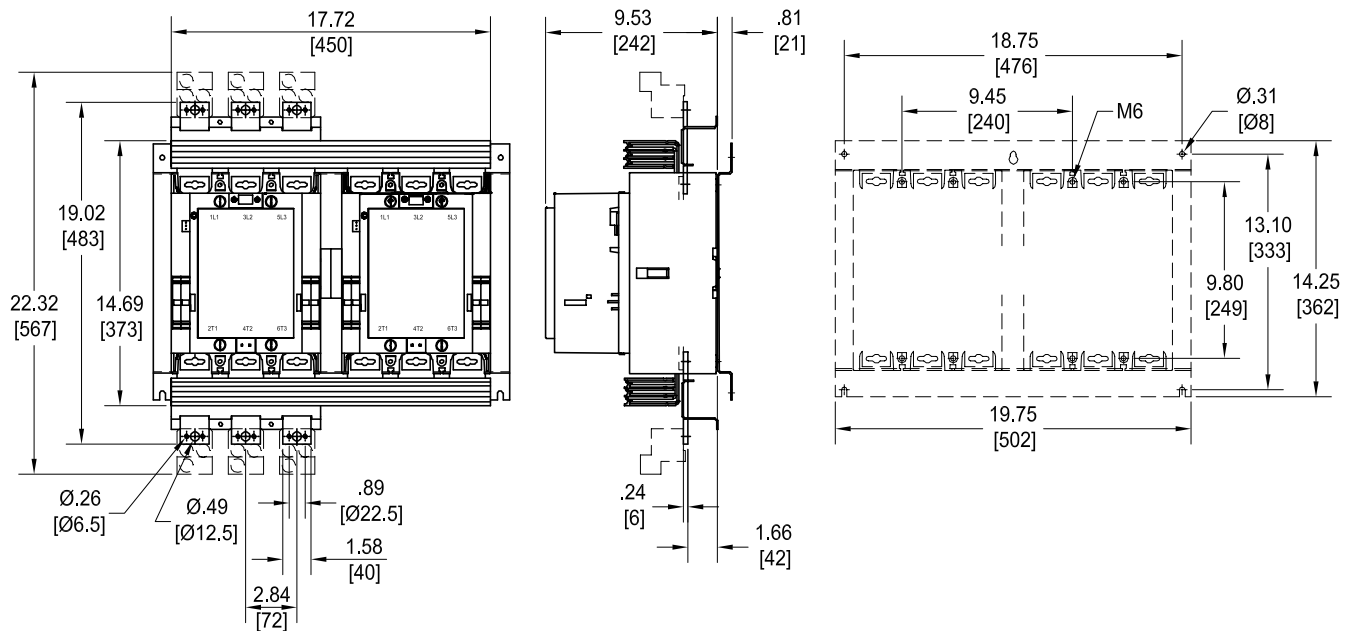

Approximate dimensions AF1250 – AF2050

00.00 Inches
00.00 [Millimeters]

AF1250 – AF2050

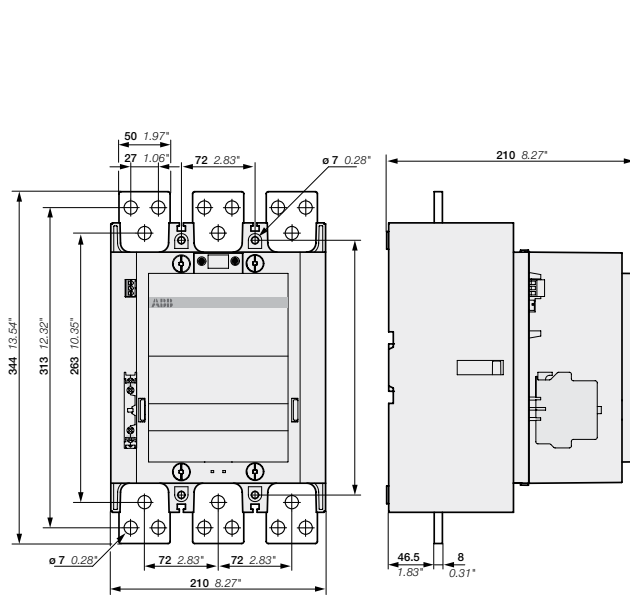

AF1250

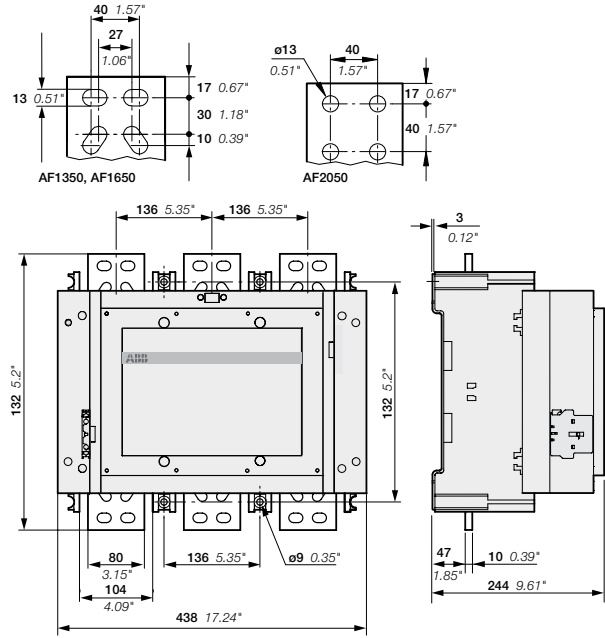

AF1350 ... AF2050

Approximate dimensions EK110 – EK550, 4 pole

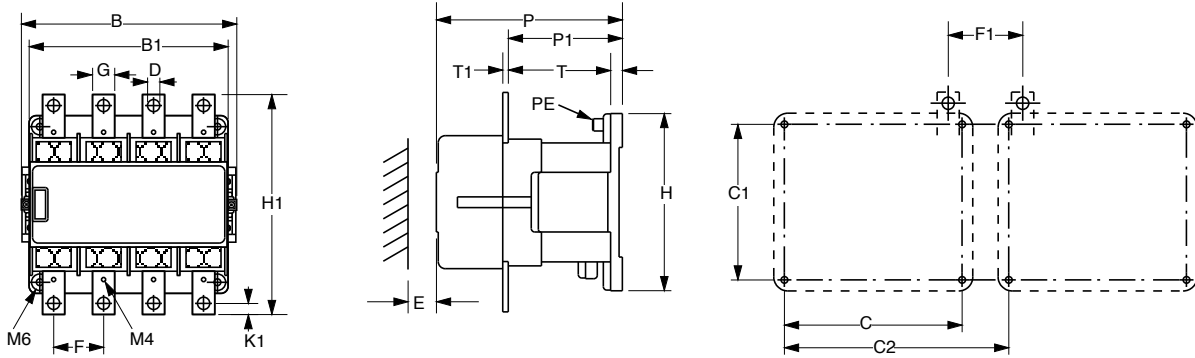

		B	B1	C	C1	D	E	F	F1	G	H	H1	K1	P	P1	T	T1
EK 110	in	6.50	5.35	4.72	5.51	0.26	1.57	1.61	1.69	0.59	6.14	6.14	0.30	6.08	4.03	0.39	0.16
	mm	165	136	120	140	6.6	40	41	43	15	156	156	7.5	154.5	102.3	10	4
EK 150	in	6.50	5.35	4.72	5.51	0.43	1.57	1.65	1.65	0.79	6.14	6.77	0.39	6.08	4.03	0.39	0.16
	mm	165	136	120	140	11	40	42	42	20	156	172	10	154.5	102.3	10	4
EK 175	in	7.91	6.93	6.30	5.51	0.43	0.59	1.77	2.64	0.79	6.14	7.80	0.39	6.77	4.20	0.39	0.20
	mm	201	176	160	140	11	15	45	67	20	156	198	10	172	106.7	10	5
EK 210	in	7.91	6.93	6.30	5.51	0.43	0.59	1.77	2.64	0.79	6.14	7.80	0.39	6.77	4.20	0.39	0.20
	mm	201	176	160	140	11	15	45	67	20	156	198	10	172	106.7	10	5
EK 370	in	10.63	9.61	8.66	7.87	0.43	1.57	2.64	2.76	0.98	8.78	10.71	0.49	8.88	5.49	0.91	0.24
	mm	270	244	220	200	11	40	67	70	25	223	272	12.5	225.5	139.5	23	6
EK 550	in	10.63	9.61	8.66	7.87	0.43	1.57	2.64	2.76	0.98	8.78	10.71	0.49	8.88	5.49	0.91	0.24
EK 1000	mm	270	244	220	200	11	40	67	70	25	223	272	12.5	225.5	139.5	23	6



ABB offers 3 contactor types for capacitive switching:

- **UA...RA contactors for capacitor switching (UA16...RA to UA110...RA)** with preinstalled damping resistors. The insertion of damping resistors protects the contactor and the capacitor from the highest inrush currents.
- **UA contactors for capacitor switching (UA16 to UA110)** Maximum permissible peak current $\hat{i} \leq 100$ times the nominal rms current of the switched capacitor.
- **A and AF standard contactors** Maximum permissible peak current $\hat{i} \leq 30$ times the nominal rms current of the switched capacitor.

Please contact Technical Support for more information.

UA...RA description

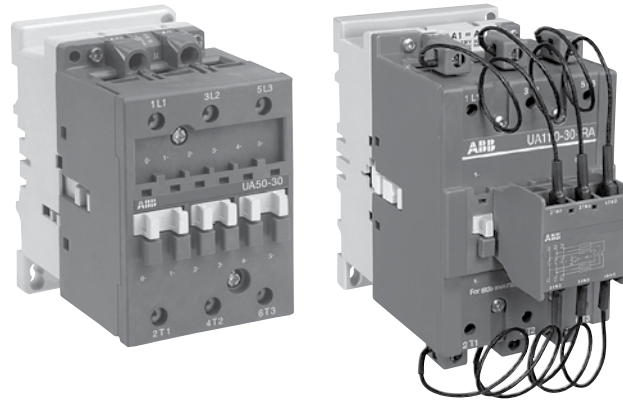
These devices intended for capacitor switching can be used for installations in which the peak current far exceeds 100 times nominal rms current. The contactors are delivered complete with their damping resistors and must be used without additional inductances. The capacitors must be discharged (maximum residual voltage at terminals ≤ 50 V) before being re-energized when the contactors are making.

- The UA...RA contactors are fitted with a special front-mounted block, which ensures the serial insertion of 3 damping resistors into the circuit to limit the current peak on energization of the capacitor bank
- Their connection also ensures capacitor precharging in order to limit the second current peak occurring upon making of the main poles
- The insertion of resistors allows to damp the highest current peak of the capacitor when switching on, whatever its level.
- Control circuit: AC operated
- Add-on auxiliary contact blocks for side mounting and a wide range of accessories.
- CE mark
- UL file #E312527 (16...75), #E36588 (95...110)
- CSA file #LR56745 (16...75), cULus (95...110)

UA description

UA contactors can be used for the switching of capacitor banks whose inrush current peaks are less than or equal to 100 times nominal rms current. The capacitors must be discharged (maximum residual voltage at terminals ≤ 50 V) before being re-energized when the contactors are making. These contactors are of the block type design with:

- Control circuit: AC operated
- Add-on auxiliary contact blocks for front or side mounting and a wide range of accessories.
- CE mark
- UL file #E312527 (26...75), #E36588 (95...110)
- CSA file #LR56745 (26...75), cULus (95...110)

Contactors for capacitive switching

AC-6b utilization category according to IEC 60947-4-1

Capacitor transient conditions

In Low Voltage industrial installations, capacitors are mainly used for reactive energy correction (raising the power factor). When these capacitors are energized, overcurrents of high amplitude and high frequencies (3 to 15 kHz) occur during the transient period (1 to 2 ms).

The amplitude of these current peaks, also known as "inrush current peaks", depends on the following factors:

- The network inductances.
- The transformer power and short-circuit voltage.
- The type of power factor correction.

There are 2 types of power factor correction: fixed or automatic.

Fixed power factor correction consists of inserting, in parallel on the network, a capacitor bank whose total power is provided by the assembly of capacitors of identical or different ratings.

The bank is energized by a contactor that simultaneously supplies all the capacitors (a single step).

The inrush current peak, in the case of fixed correction, can reach 30 times the nominal current of the capacitor bank.



Single-step capacitor bank scheme
Use the A/AF... contactor ranges.

An automatic power factor correction system, on the other hand, consists of several capacitor banks of identical or different ratings (several steps), energized separately according to the value of the power factor to be corrected.

An electronic device automatically determines the power of the steps to be energized and activates the relevant contactors.

The inrush current peak, in the case of automatic correction, depends on the power of the steps already on duty, and can reach 100 times the nominal current of the step to be energized.

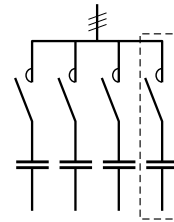

Multi-step capacitor bank scheme
Use the UA... or UA..RA contactor ranges.

Steady state condition data

The presence of harmonics and the network's voltage tolerance lead to a current, estimated to be 1.3 times the nominal current I_n of the capacitor, permanently circulating in the circuit.

Taking into account the manufacturing tolerances, the exact power of a capacitor can reach 1.15 times its nominal power.

Standard IEC 60831-1 Edition 2002 specifies that the capacitor must therefore have a maximum thermal current I_T of:

$$I_T = 1.3 \times 1.15 \times I_n = 1.5 \times I_n$$

Consequences for the contactors

To avoid malfunctions (welding of main poles, abnormal temperature rise, etc.), contactors for capacitor bank switching must be sized to withstand:

- **A permanent current that can reach 1.5 times the nominal current of the capacitor bank.**
- **The short but high peak current on pole closing** (maximum permissible peak current \hat{I}).

Contactor selection tool for capacitor switching

In a given application, if the user does not know the value of the inrush current peak, this value can be approximately calculated using the formulas given on the pages "Calculation and dimensioning".

Alternatively by the **CAPCAL selection tool**, available on the ABB Website:

www.abb.com/lowvoltage

right hand side menu

search: "Online product selection tools"

select: "Contactors: AC-6b capacitor switching"

This program allows the calculation of these peaks and gives the references of the ABB contactors according to the installation specifications. This calculation is valid for one or several capacitor banks.

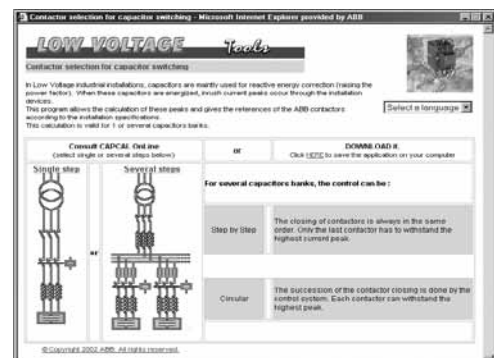

UA, UA...RA 3 pole

For capacitive switching applications up to 130 kVar
AC operated coils

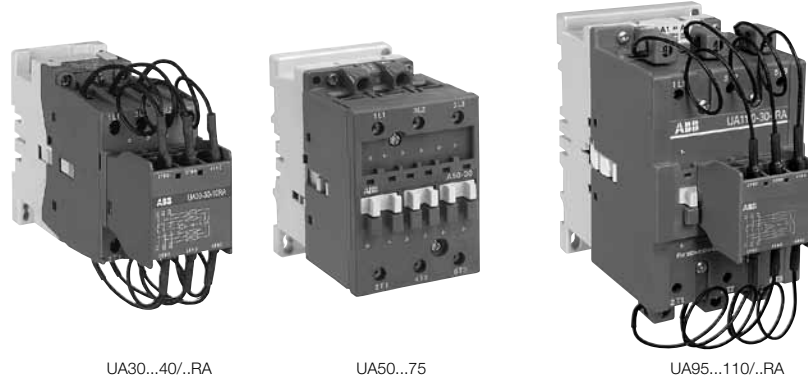

Electrical ratings

IEC/EN 60947-1
IEC/EN 60947-4-1 **CE**

UL 508/60947-4-1A **UL** **SP** **c** **UL** **us**
CSA C22.2 No.14, 60947-4-1-07

Capacitive switching

Rated operational power AC-6b, three phase, 50 Hz, 40°C (kVar)					AC capacitive switching ratings			Standard auxiliary contacts		Catalog number
230... 240V	400... 415V	440V	500... 550V	690V	Power, three phase, 60 Hz (kVar)			NO	NC	
					220... 240V	440... 480V	550... 600V			

UA...RA – rated for capacitors with peak (inrush) current $\hat{i} > 100$ times the rms current (unlimited peak current)

8	12.5	15	18	22	8	16	20	1	-	UA16-30-10-RAΔ
12.5	22	24	30	35	11	22	27	1	-	UA26-30-10-RAΔ
16	30	32	34	45	14	28	35	1	-	UA30-30-10-RAΔ
25	40	50	55	72	25	50	62	-	-	UA50-30-00-RAΔ
								1	1	UA50-30-11-RAΔ
30	50	55	65	80	27.5	55	70	-	-	UA63-30-00-RAΔ
								1	1	UA63-30-11-RAΔ
35	60	65	75	100	32	64	80	-	-	UA75-30-00-RAΔ
								1	1	UA75-30-11-RAΔ
40	70	75	85	120	40	80	100	-	-	UA95-30-00-RAΔ
								1	1	UA95-30-11-RAΔ
45	80	85	95	130	45	95	120	-	-	UA110-30-00-RAΔ
								-	1	UA110-30-11-RAΔ

UA – rated for capacitors with peak (inrush) current $\hat{i} \leq 100$ times the rms current (see technical data for values)

7.5	12.5	13.7	15.5	21.5	IEC/EN applications only – use UA...RA type			1	-	UA16-30-10-Δ
12	20	22	22	30	12.5	25	30	1	-	UA26-30-10-Δ
16	27.5	30	34	45	16	32	40	1	-	UA30-30-10-Δ
20	33	36	40	55	20	40	50	-	-	UA50-30-00-Δ
								1	1	UA50-30-11-Δ
25	45	50	50	70	IEC/EN applications only – use UA...RA type			-	-	UA63-30-00-Δ
								1	1	UA63-30-11-Δ
30	50	55	62	75	27.5	55	70	-	-	UA75-30-00-Δ
								1	1	UA75-30-11-Δ
35	65	65	70	80	35	70	75	-	-	UA95-30-00-Δ
								1	1	UA95-30-11-Δ
40	75	75	80	90	40	80	85	-	-	UA110-30-00-Δ
								-	1	UA110-30-11-Δ

Coil voltage selection chart (Δ)

Rated control circuit voltage U_c	UA16... UA110	UA16RA... UA110RA
24V 50/60	81	81
48V 50/60	83	83
110V/50, 110...120V/60	84	84
230...240V/60	80	80
400...415V/50, 480V/60	51	51
500V/50, 600V/60	55	55

UA16/RA...UA110/RA 3-pole contactors

Unlimited peak current \hat{I}

IEC & UL/CSA Technical data

Main pole - Utilization characteristics according to IEC

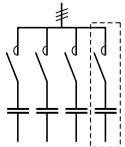
Contactor types	AC operated	UA16..RA	UA26..RA	UA30..RA	UA50..RA	UA63..RA	UA75..RA	UA95..RA	UA110..RA	
Standards		IEC 60947-1 / 60947-4-1 and EN 60947-1 / 60947-4-1								
Rated operational voltage U_e max.		690 V								
Rated frequency (without derating)		50 / 60 Hz								
AC-6b Utilization category										
Rated operational power AC-6b										
For air temperature close to contactor $\theta \leq 40^\circ\text{C}$  Multi-step capacitor bank scheme	230-240 V	8 kvar	12.5 kvar	16 kvar	25 kvar	30 kvar	35 kvar	40 kvar	45 kvar	
		400-415 V	12.5 kvar	22 kvar	30 kvar	40 kvar	50 kvar	60 kvar	70 kvar	80 kvar
		440 V	15 kvar	24 kvar	32 kvar	50 kvar	55 kvar	65 kvar	75 kvar	85 kvar
	500-550 V	18 kvar	30 kvar	34 kvar	55 kvar	65 kvar	75 kvar	85 kvar	95 kvar	
		690 V	22 kvar	35 kvar	45 kvar	72 kvar	80 kvar	100 kvar	120 kvar	130 kvar
		$\theta \leq 55^\circ\text{C}$	230-240 V	7.5 kvar	11.5 kvar	16 kvar	24 kvar	27 kvar	30 kvar	35 kvar
	400-415 V		12.5 kvar	20 kvar	27.5 kvar	40 kvar	45 kvar	50 kvar	60 kvar	70 kvar
	440 V		13 kvar	20 kvar	30 kvar	43 kvar	48 kvar	53 kvar	65 kvar	75 kvar
	500-550 V	16 kvar	25 kvar	34 kvar	50 kvar	60 kvar	65 kvar	75 kvar	82 kvar	
		690 V	21 kvar	31 kvar	45 kvar	65 kvar	75 kvar	80 kvar	105 kvar	110 kvar
		$\theta \leq 70^\circ\text{C}$	230-240 V	6 kvar	9 kvar	11 kvar	20 kvar	23 kvar	25 kvar	30 kvar
	400-415 V		10 kvar	15.5 kvar	19.5 kvar	35 kvar	39 kvar	41 kvar	53 kvar	60 kvar
440 V	11 kvar		17 kvar	20.5 kvar	37 kvar	42.5 kvar	45 kvar	58 kvar	70 kvar	
500-550 V	12.5 kvar	20 kvar	25 kvar	46 kvar	50 kvar	55 kvar	70 kvar	78 kvar		
690 V	17 kvar	26 kvar	32 kvar	60 kvar	65 kvar	70 kvar	85 kvar	100 kvar		
Max. permissible peak current \hat{I}		Unlimited								
Short-circuit protection device for contactors		80 A		125 A	200 A			250 A		
gG type fuse (1)		80 A		125 A	200 A			250 A		
Max. electrical switching frequency		240 cycles/h								
Electrical durability AC-6b	$U_e \leq 440\text{ V}$	250 000 operating cycles								
	$500\text{ V} \leq U_e \leq 690\text{ V}$	100 000 operating cycles								

(1) The fuse ratings given represent the maximum ratings ensuring type 1 coordination according to the definition of standard IEC 60947-4-1.

Main pole - Utilization characteristics according to UL / CSA

Contactor types	AC operated	UA16..RA	UA26..RA	UA30..RA	UA50..RA	UA63..RA	UA75..RA	UA95..RA	UA110..RA	
Power - 60 Hz										
For air temperature close to contactor	$\theta \leq 40^\circ\text{C}$	240 V	8 kvar	11 kvar	14 kvar	25 kvar	27.5 kvar	32 kvar	40 kvar	45 kvar
		480 V	16 kvar	22 kvar	28 kvar	50 kvar	55 kvar	64 kvar	80 kvar	95 kvar
		600 V	20 kvar	27 kvar	35 kvar	62 kvar	70 kvar	80 kvar	100 kvar	120 kvar
Max. permissible peak Current \hat{I}		Unlimited								

Operating principle

The front-mounted block mechanism of the UA..RA contactors ensures:

- early making of the auxiliary "PA" poles with respect to the main "PP" poles
- automatic return to the open position of the auxiliary "PA" poles after the main poles are closed.

When the coil is energized, the early making auxiliary poles connect the capacitor to the network via the set of 3 resistors. The damping resistors attenuate the first current peak and the second inrush current when the main contacts begin to make. Once the main poles are in the closed position, the auxiliary poles automatically break.

When the coil is de-energized, the main poles break ensuring the breaking of the capacitor bank.

The contactor can then begin a new cycle.

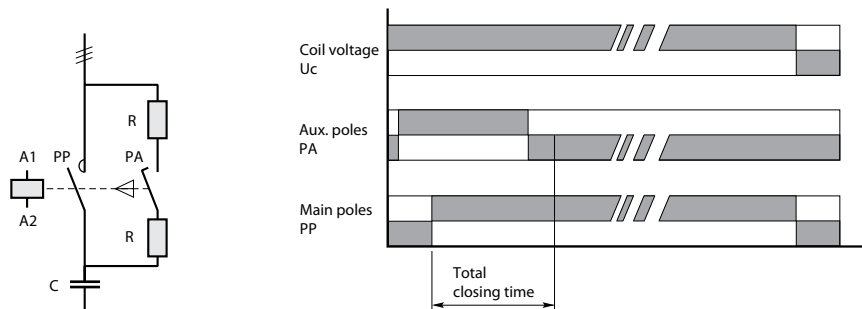

The insertion of resistors allows to damp the highest current peak of the capacitor when switching on, whatever its level.

UA16/RA...UA110/RA 3-pole contactors











Unlimited peak current \hat{I}

General technical data

Capacitive
switching

1

Connecting characteristics

Contactor types	AC operated	UA16..RA	UA26..RA	UA30..RA	UA50..RA UA63..RA UA75..RA	UA95..RA UA110..RA			
Connection capacity (min. ... max.)									
Main conductors (poles)									
	Rigid	Solid ($\leq 4 \text{ mm}^2$)	1 x	1...4 mm ²	1.5...6 mm ²	2.5...16 mm ²	6...50 mm ²	10...95 mm ²	
		Stranded ($\geq 6 \text{ mm}^2$)	2 x	-	-	2.5...16 + 2.5...6 mm ²	6...25 + 6...16 mm ²	6...35 mm ²	
	Flexible with ferrule		1 x	0.75...2.5 mm ²	1.5...4 mm ²	2.5...10 mm ²	6...35 mm ²	10...70 mm ²	
			2 x	-	-	2.5...10 + 2.5...4 mm ²	6...16 + 6...10 mm ²	6...35 mm ²	
	Bars or lugs		L \leq	7.7 mm	10 mm	-	-	-	
			L $>$	3.7 mm	4.2 mm	-	-	-	
Connection capacity acc. to UL/CSA									
			1 or 2 x	AWG 18...10	AWG 12...8	AWG 8...4	AWG 8...1	AWG 6...2/0	
Tightening torque		Recommended		1 Nm / 9 lb.in	1.7 Nm / 15 lb.in	2.3 Nm / 20 lb.in	4 Nm / 35 lb.in	8 Nm / 53 lb.in	
		Max.		1.2 Nm	2.2 Nm	2.6 Nm	4.5 Nm	9 Nm	
Auxiliary conductors (built-in auxiliary terminals + coil terminals)									
	Rigid solid		1 x	1...4 mm ²				0.75...2.5 mm ²	
			2 x	1...4 mm ²				0.75...2.5 mm ²	
	Flexible with ferrule		1 x	0.75...2.5 mm ²			1...2.5 mm ²	0.75...2.5 mm ²	
			2 x	0.75...2.5 mm ²				0.75...2.5 mm ²	
	Lugs	Coil terminals	L \leq	8 mm					
			L $>$	3.7 mm					
		Built-in auxiliary terminals	L \leq	7.7 mm	10 mm	8 mm	-	-	
			L $>$	3.7 mm	4.2 mm	3.7 mm	-	-	
Connection capacity acc. to UL/CSA									
			1 or 2 x	AWG 18...14					
Tightening torque									
Coil terminals		Recommended		1 Nm / 9 lb.in					
		Max.		1.2 Nm					
Built-in auxiliary terminals		Recommended		1 Nm / 9 lb.in					
		Max.		1.2 Nm					
Degree of protection acc. to IEC 60947-1 / EN 60947-1 and IEC 60529 / EN 60529									
Main terminals				IP20		IP10			
Coil terminals				IP20					
Built-in auxiliary terminals				IP20			-	-	
Screw terminals									
Main terminals									
				Delivered in open position, screws of unused terminals must be tightened					
			Screwdriver type	M 3.5	M 4	M 5	M 6	M 8	
				Flat \varnothing 5.5 / Pozidriv 2				Flat \varnothing 6.5 / Pozidriv 2	Hexagon socket (s = 4 mm)
Coil terminals									
			Screwdriver type	M 3.5					
				Flat \varnothing 5.5 / Pozidriv 2					
Built-in auxiliary terminals									
			Screwdriver type	M 3.5	M 4	M 3.5	-	-	
				Flat \varnothing 5.5 / Pozidriv 2				-	-

Other technical characteristics are the same as those of standard A contactors.

UA16...UA110 3-pole contactors

Peak current $\hat{I} \leq 100$ times the rms current
IEC & UL/CSA technical data

Main pole - Utilization characteristics according to IEC

Contactor types	AC operated	UA16	UA26	UA30	UA50	UA63	UA75	UA95	UA110	
Standards		IEC 60947-1 / 60947-4-1 and EN 60947-1 / 60947-4-1								
Rated operational voltage U_e max.		690 V								
Rated frequency (without derating)		50 / 60 Hz								
AC-6b Utilization category										
Rated operational power AC-6b (1)										
For air temperature close to contactor	$\theta \leq 40^\circ\text{C}$	230-240 V	7.5 kvar	12 kvar	16 kvar	20 kvar	25 kvar	30 kvar	35 kvar	40 kvar
		400-415 V	12.5 kvar	20 kvar	27.5 kvar	33 kvar	45 kvar	50 kvar	65 kvar	75 kvar
	$\theta \leq 55^\circ\text{C}$	440 V	13.7 kvar	22 kvar	30 kvar	36 kvar	50 kvar	55 kvar	65 kvar	75 kvar
		500-550 V	15.5 kvar	22 kvar	34 kvar	40 kvar	50 kvar	62 kvar	70 kvar	80 kvar
	$\theta \leq 70^\circ\text{C}$	690 V	21.5 kvar	30 kvar	45 kvar	55 kvar	70 kvar	75 kvar	80 kvar	90 kvar
		230-240 V	6.7 kvar	11 kvar	16 kvar	20 kvar	25 kvar	30 kvar	35 kvar	40 kvar
		400-415 V	11.7 kvar	18.5 kvar	27.5 kvar	33 kvar	43 kvar	50 kvar	65 kvar	70 kvar
		440 V	13 kvar	20 kvar	30 kvar	36 kvar	48 kvar	53 kvar	65 kvar	75 kvar
		500-550 V	14.7 kvar	22 kvar	34 kvar	40 kvar	50 kvar	62 kvar	70 kvar	80 kvar
		690 V	20 kvar	30 kvar	45 kvar	55 kvar	70 kvar	75 kvar	80 kvar	90 kvar
		230-240 V	6 kvar	8.5 kvar	11 kvar	19 kvar	21 kvar	22 kvar	30 kvar	35 kvar
		400-415 V	10 kvar	14.5 kvar	19 kvar	32 kvar	37 kvar	39 kvar	55 kvar	65 kvar
		440 V	11 kvar	16 kvar	20 kvar	35 kvar	41 kvar	43 kvar	55 kvar	70 kvar
		500-550 V	12.5 kvar	19.5 kvar	23.5 kvar	40 kvar	45 kvar	47.5 kvar	60 kvar	75 kvar
		690 V	17 kvar	25 kvar	32 kvar	52 kvar	60 kvar	65 kvar	70 kvar	85 kvar
		$U_e \leq 500$ V	1.8 kA	3 kA	3.5 kA	5 kA	6.5 kA	7.5 kA	9.3 kA	10.5 kA
Max. permissible peak current \hat{I}		$U_e > 500$ V	1.6 kA	2.7 kA	3.1 kA	4.5 kA	5.8 kA	6.75 kA	8 kA	9 kA
Short-circuit protection device for contactors		sized 1.5...1.8 In of the capacitor								
gG type fuse										
Max. electrical switching frequency		240 cycles/h								
Electrical durability AC-6b	$U_e \leq 690$ V	100 000 operating cycles								

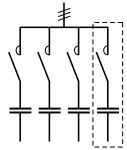

Multi-step capacitor bank scheme

(1) For 220 V and 380 V, multiply by 0.9 the rated values at 230 V and 400 V respectively.
Example: 50 kvar / 400 V corresponding to $0.9 \times 50 = 45$ kvar/380 V.

If, in an application, the current peak is greater than the maximum peak current \hat{I} specified in the tables above, select a higher rating, refer to the UA..RA contactors, or add inductances. (see application guide "Contactors for capacitor switching").

Main pole - Utilization characteristics according to UL / CSA











Contactor types	AC operated	UA16	UA26	UA30	UA50	UA63	UA75	UA95	UA110	
Power - 60 Hz										
For air temperature close to contactor	$\theta \leq 40^\circ\text{C}$	240 V	-	12.5 kvar	16 kvar	20 kvar	-	27.5 kvar	35 kvar	40 kvar
		480 V	-	25 kvar	32 kvar	40 kvar	-	55 kvar	70 kvar	80 kvar
		600 V	-	30 kvar	40 kvar	50 kvar	-	70 kvar	75 kvar	85 kvar

If, in an application, the current peak is greater than the maximum peak current \hat{I} specified in the tables above, select a higher rating, refer to the UA..RA contactors, or add inductances. (see application guide "Contactors for capacitor switching").

UA16 ... UA110 3-pole contactors

Peak current $\hat{I} \leq 100$ times the rms current
General technical data

Connecting characteristics

Contactor types	AC operated	UA16	UA26	UA30	UA50 UA63 UA75	UA95 UA110	
Connection capacity (min. ... max.)							
Main conductors (poles)							
	Rigid	Solid ($\leq 4 \text{ mm}^2$)	1 x 1...4 mm ²	1.5...6 mm ²	2.5...16 mm ²	6...50 mm ²	10...95 mm ²
		Stranded ($\geq 6 \text{ mm}^2$)	2 x 1...4 mm ²	1.5...6 mm ²	2.5...16 mm ²	6...25 mm ²	6...35 mm ²
	Flexible with ferrule		1 x 0.75...2.5 mm ²	0.75...4 mm ²	2.5...10 mm ²	6...35 mm ²	10...70 mm ²
			2 x 0.75...2.5 mm ²	0.75...4 mm ²	2.5...10 mm ²	6...16 mm ²	6...35 mm ²
	Bars or lugs		L \leq 7.7 mm	10 mm	-	-	-
			I $>$ 3.7 mm	4.2 mm	-	-	-
Connection capacity acc. to UL/CSA			1 or 2 x AWG 18...10	AWG 12...8	AWG 8...4	AWG 8...1	AWG 6...2/0
Tightening torque		Recommended	1 Nm / 9 lb.in	1.7 Nm / 15 lb.in	2.3 Nm / 20 lb.in	4 Nm / 35 lb.in	8 Nm / 71 lb.in
		Max.	1.2 Nm	2.2 Nm	2.6 Nm	4.5 Nm	9 Nm
Auxiliary conductors (built-in auxiliary terminals + coil terminals)							
	Rigid solid		1 x 1...4 mm ²				0.75...2.5 mm ²
			2 x 1...4 mm ²				0.75...2.5 mm ²
	Flexible with ferrule		1 x 0.75...2.5 mm ²			1...2.5 mm ²	0.75...2.5 mm ²
			2 x 0.75...2.5 mm ²				0.75...2.5 mm ²
	Lugs	Coil terminals	L \leq 8 mm				
			I $>$ 3.7 mm				
		Built-in auxiliary terminals	L \leq 7.7 mm	10 mm	8 mm	-	-
			I $>$ 3.7 mm	4.2 mm	3.7 mm	-	-
Connection capacity acc. to UL/CSA			AWG 18...14				
Tightening torque							
Coil terminals		Recommended	1 Nm / 9 lb.in				
		Max.	1.2 Nm				
Built-in auxiliary terminals		Recommended	1 Nm / 9 lb.in				
		Max.	1.2 Nm				
Degree of protection acc. to IEC 60947-1 / EN 60947-1 and IEC 60529 / EN 60529							
Main terminals			IP20			IP10	
Coil terminals			IP20				
Built-in auxiliary terminals			IP20				
Screw terminals Delivered in open position, screws of unused terminals must be tightened							
Main terminals			M3.5	M4	M5	M6	M8
		Screwdriver type	Flat \varnothing 5.5 / Pozidriv 2		Flat \varnothing 6.5 / Pozidriv 2		Hexagon socket (s = 4 mm)
Coil terminals			M3.5				
		Screwdriver type	Flat \varnothing 5.5 / Pozidriv 2				
Built-in auxiliary terminals			M3.5	M4	M3.5	-	-
		Screwdriver type	Flat \varnothing 5.5 / Pozidriv 2			-	-

Other technical characteristics are the same as those of standard A contactors.

Approximate dimensions

Main dimensions mm, inches

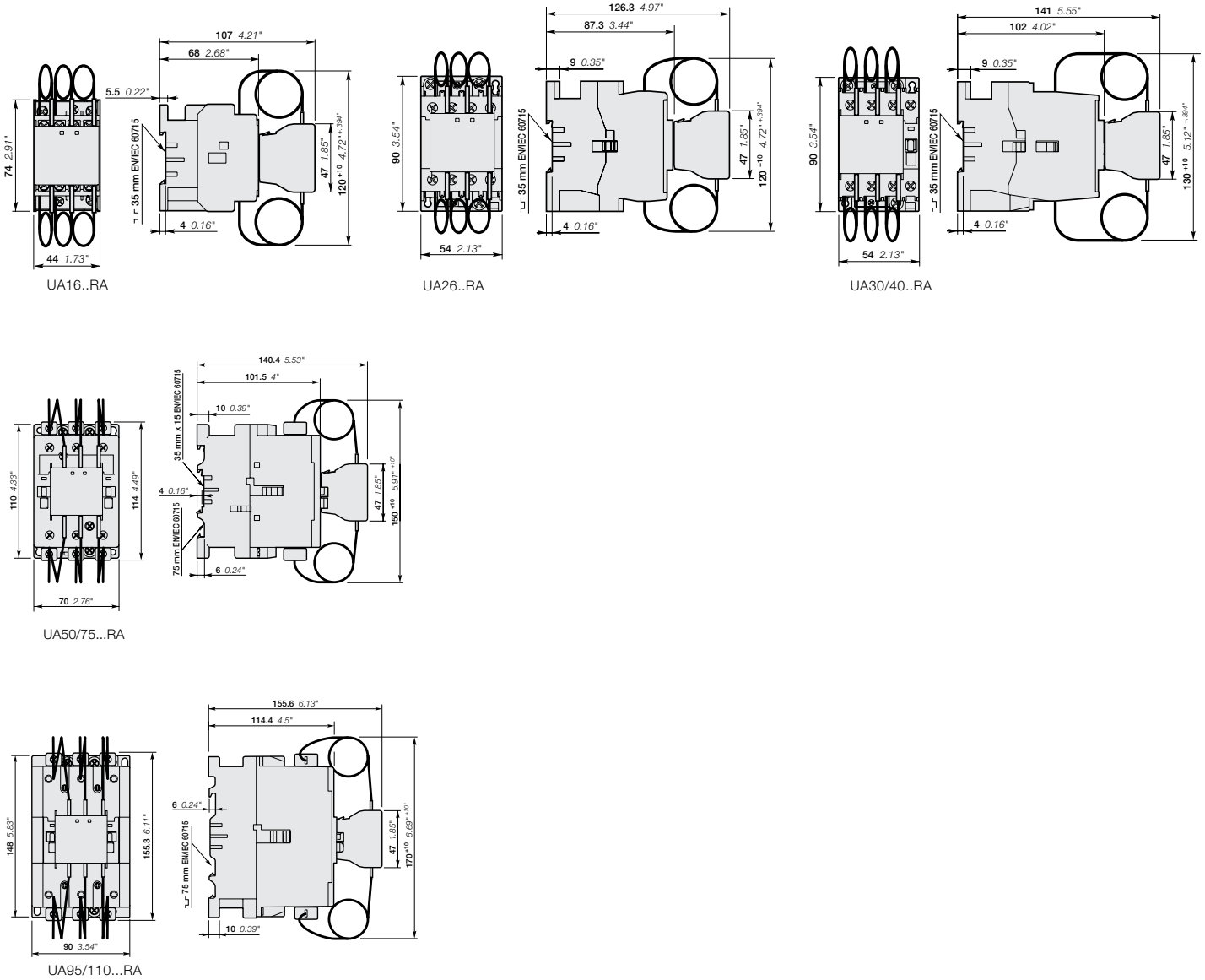

Note: dimensions for UA... contactor identical to UA...RA types less front-mount dampening resistors.



Definite purpose contactors

For applications up to 90 FLA

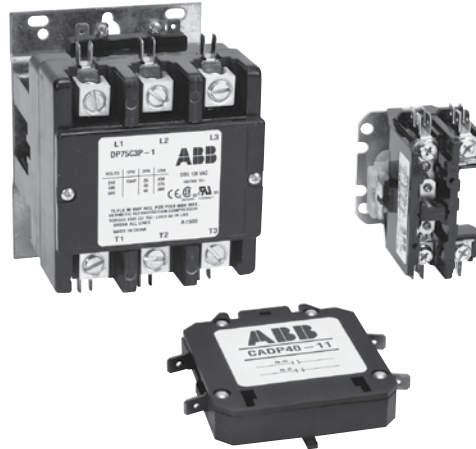

Definite purpose Contactors

Applications

Type DP contactors provide high performance with flexibility and reliability, designed to match numerous applications including:

- Motors
- Power supplies
- Food service equipment
- Compressors
- Business machines
- Resistive heating
- Air conditioning
- Refrigeration equipment
- Welding

Agency approvals

- UL 508 Guide No. NLDX2, File # E224401
- CSA C22.2 No. 221260 (1456104)
Class 3211 04 / 3211 84
- CE/Semko Certified, EN60947-4-1:2001

Features

- Available as:
 - 20A, 25A, 1, 2 or 3 pole
 - 30A, 1, 2, 3 or 4 pole
 - 40A, 2, 3 or 4 pole
 - 50-90A, 3 pole
- Industry standard mounting plate provides easily accessible mounting holes
- Coil terminals are provided with #6-32 screws and (1) .250 quick connect or dual .250 quickconnect terminals
- Exclusive hex, slotted, phillips #10-32 terminal screws for main terminals
- Coil is class B (130° C) insulation system with a wide range of voltages and 50/60 Hz ratings
- Double E magnet assembly provides optimal performance with reduced power consumption
- Snap-in auxiliary switch with 1 SPDT or 2 SPDT contacts available as an option
- 1 N.O. & 1 N.C. auxiliary contact block with 600 VAC rating available as an option
- Base assembly is made from high arc-resistant polyesterplastic

Catalog number explanation

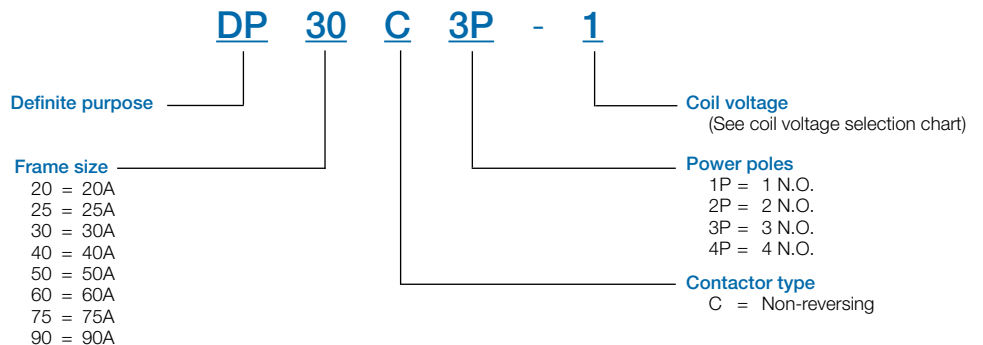

DP non-reversing 1, 2, 3 & 4 pole

For definite purpose applications up to 90 FLA
AC operated coils



DP20C1P...
DP40C1P



DP20C3P...
DP30C3P



DP40C4P

Electrical ratings

AC definite purpose controller ratings				AC resistance air heating, per pole (A)	AC motor ratings, breaking all lines (hp)					N.O. power poles	Catalog number	Catalog number (bulk pack)	Bulk qty.	
Full load amperes (FLA)	Locked rotor Amperes, breaking all lines (LRA) ①				Single phase	Three phase								
	220...240 / 277V	440... 480V	550... 600V			110... 120V	220... 240V	220... 240V	440... 480V					550... 600V
20	120	100	80	30	-	-	-	-	-	1	DP20C1P-Δ	DP20C1P-Δ/B	50	
25	150	125	100	35	-	-	-	-	-		DP25C1P-Δ	DP25C1P-Δ/B		
30	180	125	100	40	-	-	-	-	-		DP30C1P-Δ	DP30C1P-Δ/B		
40	240	160	120	50 ④	-	-	-	-	-		DP40C1P-Δ	DP40C1P-Δ/B		
20	120	100	80	30	-	-	-	-	-	2	DP20C2P-Δ	DP20C2P-Δ/B	50	
25	150	125	100	35	-	-	-	-	-		DP25C2P-Δ	DP25C2P-Δ/B		
30	180	125	100	40	-	-	-	-	-		DP30C2P-Δ	DP30C2P-Δ/B		
40	240	160	120	50 ④	-	-	-	-	-		DP40C2P-Δ	DP40C2P-Δ/B		
20	120	100	80	30	1.5	3	7.5	7.5	7.5	3	DP20C3P-Δ	DP20C3P-Δ/B	25	
25	150	125	100	35	2	5	7.5	15	20		DP25C3P-Δ	DP25C3P-Δ/B		
30	180	150	120	40	2	5	10	15	20		DP30C3P-Δ	DP30C3P-Δ/B		
40	240	200	160	50 ⑤	3	7.5	10	20	25		DP40C3P-Δ	DP40C3P-Δ/B		
50	300 ③	250	200	65	3	7.5 ⑥	15 ⑥	25	25		DP50C3P-Δ	-		-
60	360 ③	300	240	75	5	10 ⑥	25 ⑥	30	30		DP60C3P-Δ	-		-
75	450 ③	375	300	90	5	15	25 ⑥	40	40		DP75C3P-Δ	-		-
90	540 ③	450	360	120	7.5	20	30 ⑥	50	50		DP90C3P-Δ	-		-
20	120	100	80	30	1.5	3	7.5	7.5	7.5	4	DP20C4P-Δ	DP20C4P-Δ/B	25	
25	150	125	100	35	2	5	7.5	15	20		DP25C4P-Δ	DP25C4P-Δ/B		
30	180	150	120	40	2	5	10	15	20		DP30C4P-Δ	DP30C4P-Δ/B		
40	240	200	160	50 ⑤	3	7.5	10	20	25		DP40C4P-Δ	DP40C4P-Δ/B		

Note: 1-pole devices in 2-pole frame with shunt included.

Coil voltage selection chart (Δ)

Control circuit voltage	Control circuit voltage
24V 60 Hz	F
120V/60	1
208/240V AC	2
277V AC	C
480V AC	4
575/600V 60 Hz	6

DP ratings for AF & AS/ASL

ABB has additionally performed definite purpose testing for air conditioning (h.r.c.) applications with AF and AS/ASL series contactors. Please contact Technical Support regarding the use of these devices for applications 20...900 FLA, 80...5600 LRA.

① 1- & 2-pole devices rated per pole
 ② DP20...DP30 intended for single phase resistive applications only above 277V
 ③ 220...240V only
 ④ Max. 277V
 ⑤ Breaking all lines
 ⑥ Suitable at 208V

Accessories



Auxiliary contact blocks

Description	DP20 to DP40, 3 pole and 4 pole configurations	DP50 to DP60	DP75 to DP90*
Form C SPDT	CADP40-10	CADP40-10	-
Double Form C SPDT	CADP40-20	CADP40-20	-
Form Z SPDT (1NO & 1NC)**	CADP40-11	CADP40-11	CADP90-11

** Must be the same polarity on both poles. For a complete description on contact types, please refer to page 1.78.

Mechanical interlock

Application	Catalog number
DP30C3P-*	VM DP-1
DP40C3P-*	VM DP-1

Protective cover

Application	Catalog number
DP20C2P-*	DP-2-AC
DP25C2P-*	DP-2-AC
DP30C2P-*	DP-2-AC

Din-rail mounting bracket

Application	Catalog number
DP20C1P-*	DP/DIN1-2
DP25C1P-*	DP/DIN1-2
DP30C1P-*	DP/DIN1-2
DP20C2P-*	DP/DIN1-2
DP25C2P-*	DP/DIN1-2
DP30C2P-*	DP/DIN1-2

Note: Replace "*" with appropriate coil voltage as per previous page

Technical data

Contact rating of SPDT auxiliary contacts

Voltage	Current rating
125 VAC	10 A, 1/3 HP
120 VAC	4 A on lamp load
250 VAC	10 A, 1/3 HP
125 VDC	0.5 A
250 VDC	0.25 A

Contact rating of 1 N.O. & 1 N.C. auxiliary contacts

	120V	240V	480V	600V
Break (A)	3.0	1.5	0.75	0.6
Make (A)	30	15	7.5	6
Continuous (A)	10	10	10	10

DP20 to DP40, 1 & 2 poles

Coil technical data		DP20 to DP30, 1 pole				DP20 to DP40, 2 poles			
Nominal coil voltage		24	120	208/240	277	24	120	208/240	277
Maximum pickup volts		18	88	177	221	18	88	177	221
Drop out volts range		6 - 15	20 - 70	40 - 140	50 - 165	6 - 15	20 - 70	40 - 170	50 - 165
Nominal inrush VA	50 Hz	31	31	31	31	33	33	33	33
Nominal inrush VA	60 Hz	28	28	28	28	30	30	30	30
Nominal closed VA	50 Hz	6	6	6	6	8	8	8	8
Nominal closed VA	60 Hz	5	5	5	5	6.5	6.5	6.5	6.5
Nominal coil resistance	Ohms	18	420	1800	2500	11	237	1000	1600

Other specifications

Specifications	DP20 to DP30, 1 and 2 poles	DP40, 2 poles
Line and load terminals	# 10 - 32 screw	Box lug
Wire size AWG (min - max)	16 - 8	14 - 4 Cu/Al
Tightening torque (recommended)	25 in. lbs.	40 in. lbs.
Coil terminals	Dual .250" QC	Dual .250" QC
Power Terminals	1 Pole: Quad .250" QC 2 Pole: Dual or Quad .250" QC	Quad Dual or quad
Covers	Optional	Standard
Insulation System	130° C class B	130° C class B

DP20 to DP60, 3 poles

Coil technical data		DP20 to DP40, 3 poles					DP50 to DP60, 3 poles				
Nominal coil voltage		24	120	208/240	277	480	24	120	208/240	277	480
Maximum pickup volts		18	88	177	220	384	18	88	177	220	374
Drop out volts range		6 - 15	20 - 70	40 - 140	50 - 140	150 - 270	6 - 15	20 - 70	40 - 140	50 - 185	150 - 286
Nominal inrush VA	50 Hz	65	65	65	65	65	62	62	62	62	62
Nominal inrush VA	60 Hz	60	60	60	60	60	59	59	59	59	59
Nominal closed VA	50 Hz	7.5	7.5	7.5	7.5	7.5	9	9	9	9	9
Nominal closed VA	60 Hz	6	6	6	6	6	7	7	6	7	7
Nominal coil resistance	Ohms	7	180	720	900	1320	2.4	150	600	750	1452

Other specifications

Specifications	DP20 to DP30, 3 poles	DP40, 3 poles	DP50 to DP60, 3 poles
Line and load terminals	# 10 - 32 screw ①	Box lug ①	Box lug ①
Wire size AWG (min - max)	16 - 8 2	14 - 4 Cu/Al	14 - 2 Cu/Al
Tightening torque (recommended)	22 in. lbs.	40 in. lbs.	50 in. lbs.
Quick connects (power terminals)	Dual .250 QC	Dual .250 QC	Dual .250 QC
Coil terminals	Dual .250 QC ②	Dual .250 QC ②	# 6 - 32 screw & dual .250 QC ②
Covers	Standard	Standard	Standard
Insulation system	130° C class B	130° C class B	130° C class B

① See diagram on page 1.183 for approximate dimensions and description.

② Stranding must be split for # 8 wire.

DP20 to DP40, 4 poles

Coil technical data		DP20 to DP40, 4 poles				
Nominal coil voltage		24	120	208/240	277	480
Maximum pickup volts		18	88	177	220	384
Drop out volts range		6 - 15	20 - 70	40 - 140	65 - 185	150 - 270
Nominal inrush VA	50 Hz	62	62	62	62	62
Nominal inrush VA	60 Hz	59	59	59	59	59
Nominal closed VA	50 Hz	9	9	9	9	9
Nominal closed VA	60 Hz	7	7	6	7	6
Nominal coil resistance	Ohms	6	148	600	750	2100

Other specifications

Specifications	DP20 to DP30, 4 poles	DP40, 4 poles
Line and load terminals	# 10 - 32 screw ①	Box lug ①
Wire size AWG (min - max)	16 - 8 2	14 - 4 Cu/Al
Tightening torque (recommended)	22 in. lbs.	40 in. lbs.
Quick connects (power terminals)	Dual .250 QC	Dual .250 QC
Coil terminals	Dual .250 QC ②	Dual .250 QC ②
Covers	Standard	Standard
Insulation system	130° C class B	130° C class B

DP75 to DP90, 3 poles

Coil technical data		DP75 to DP90, 3 poles				
Nominal coil voltage		24	120	208/240	277	480
Maximum pickup volts		18	88	177	220	384
Drop out volts range		6-15	20-70	40-10	65-185	150 - 270
Nominal inrush VA	50 Hz	285	285	285	285	62
Nominal inrush VA	60 Hz	240	240	240	240	59
Nominal closed VA	50 Hz	42	42	42	42	9
Nominal closed VA	60 Hz	27	27	27	27	6
Nominal coil resistance	Ohms	0.65	16	64	85	2100

Other specifications

Specifications	DP75 to DP90, 3 poles
Line and load terminals	Box lug (1)
Wire size AWG (min-max)	14-1 Cu/Al
Tightening torque (recommended)	50 in. lbs
Quick connects (power terminals)	Dual .250" QC
Coil terminals	Dual .250" QC
Covers	Standard
Insulation system	130°C Class B

① See diagram on page 1.183 for approximate dimensions and description.
 ② Stranding must be split for # 8 wire.

Approximate dimensions

DP20 to DP30, 1 pole

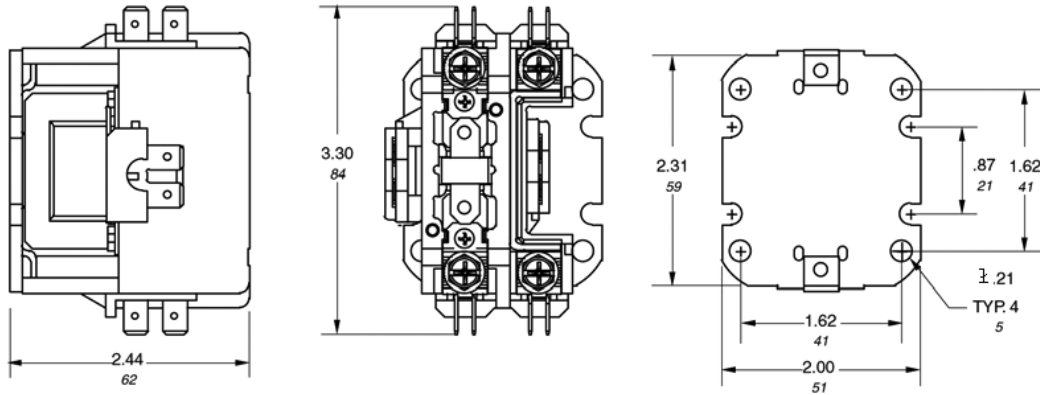

DP20 to DP30, 2 poles

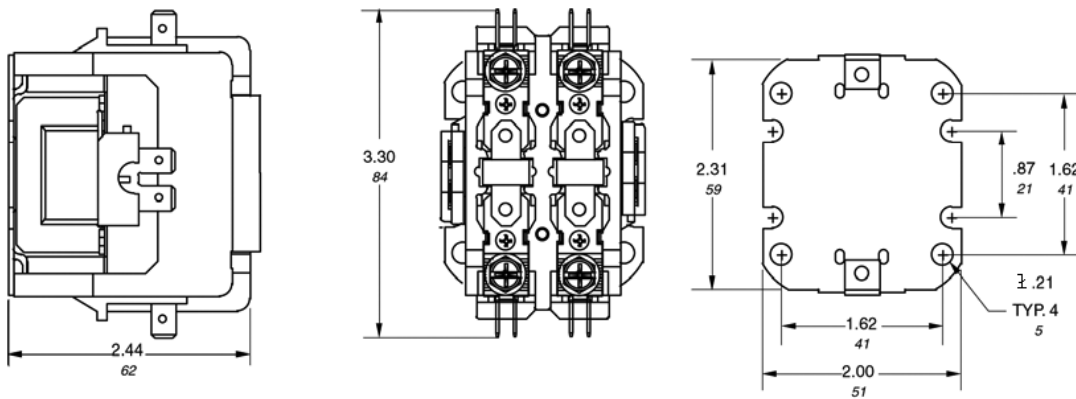

DP20 to DP30, 3 poles

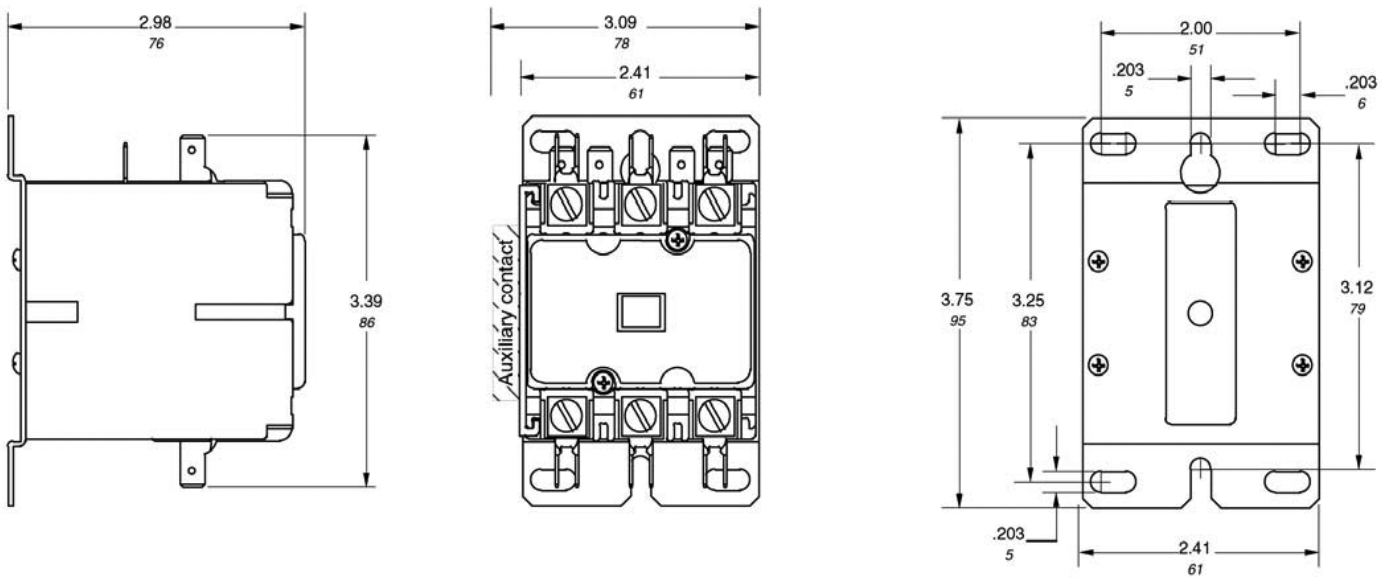

Approximate dimensions

Definite purpose
contactors 1

DP30, 4 poles

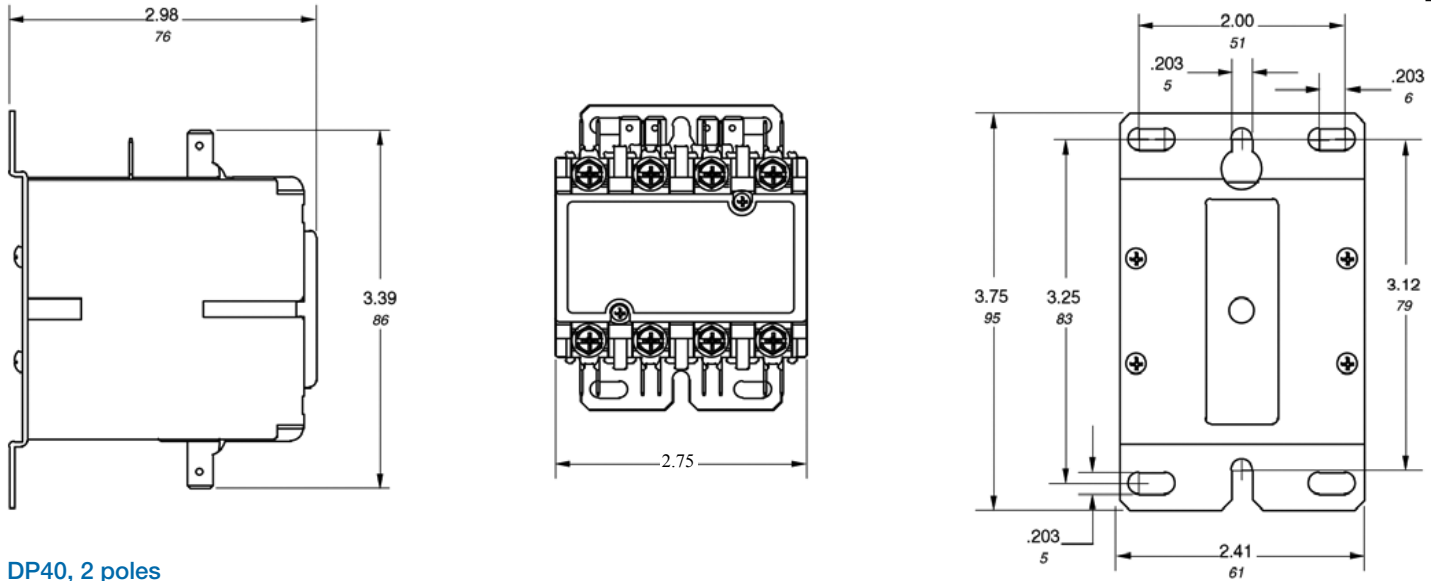

DP40, 2 poles

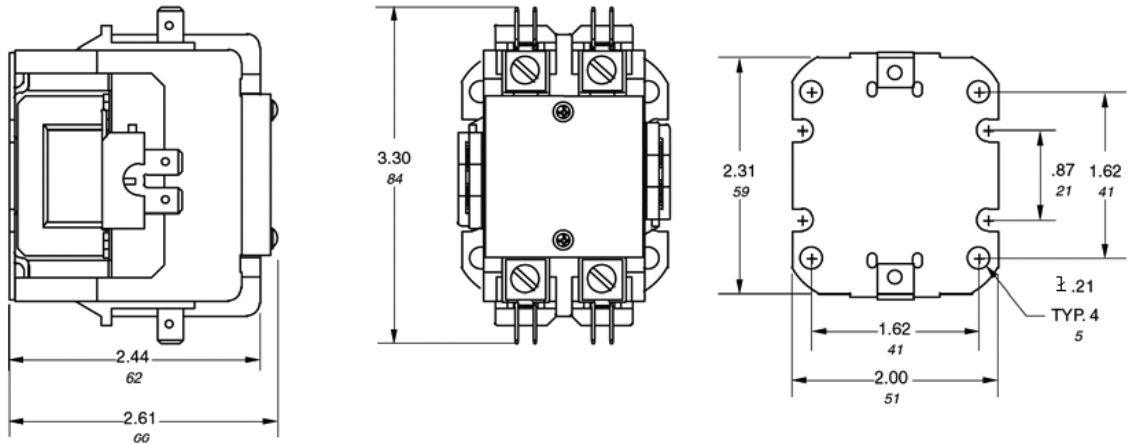

DP40, 3 poles

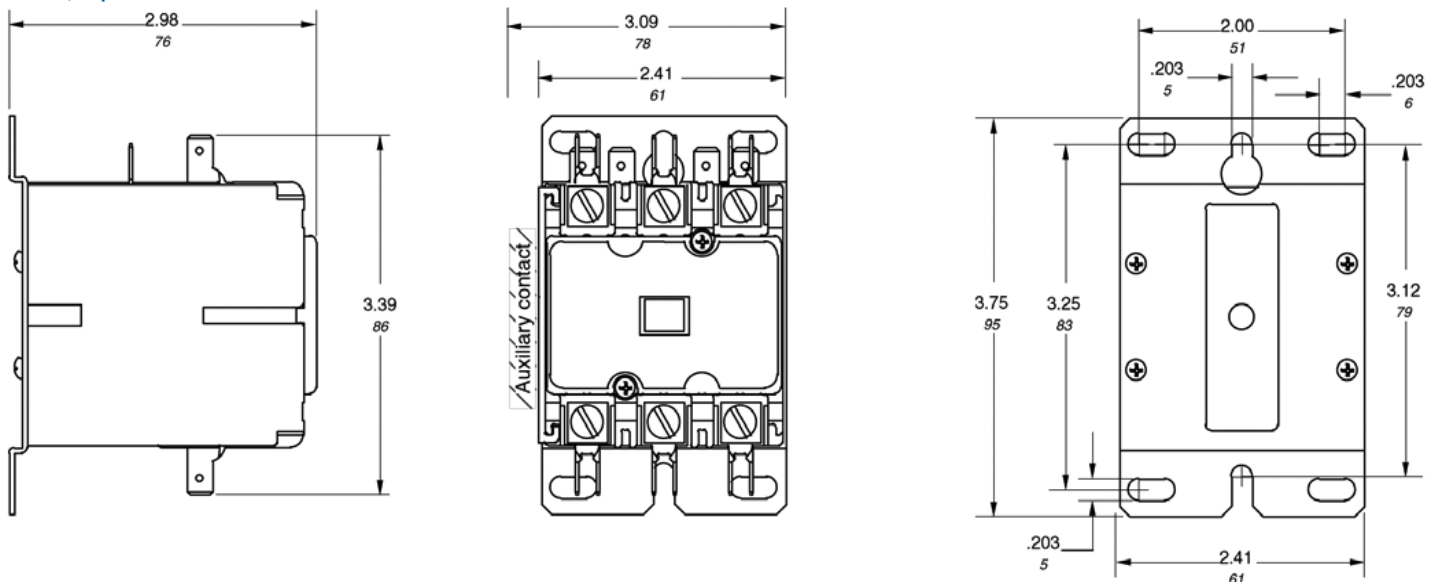

Approximate dimensions

DP40, 4 poles

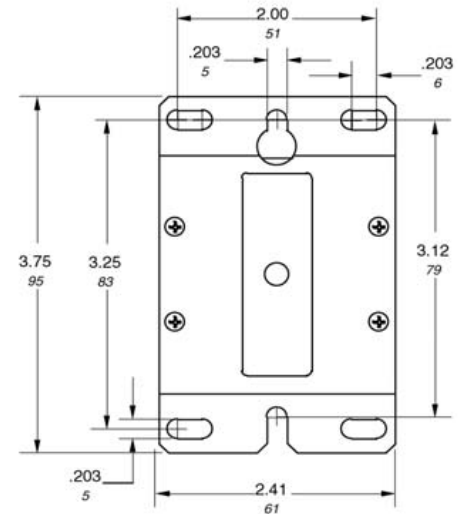
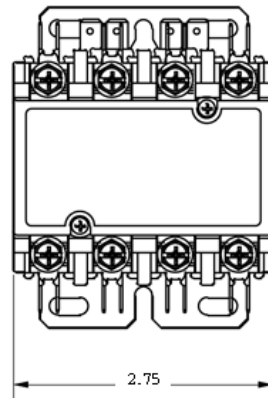
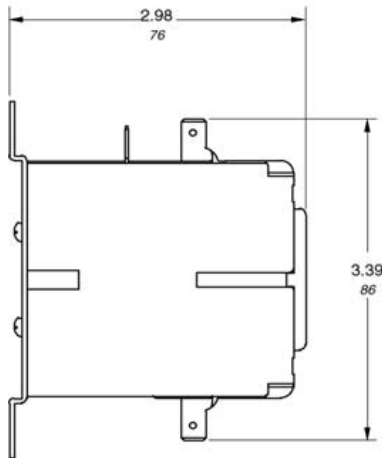

DP50 to DP60, 3 poles

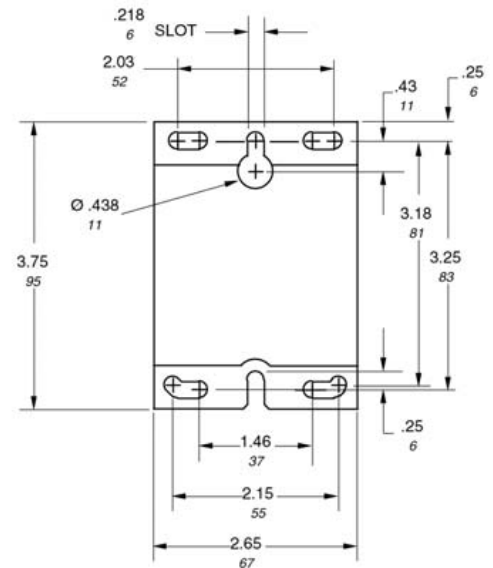
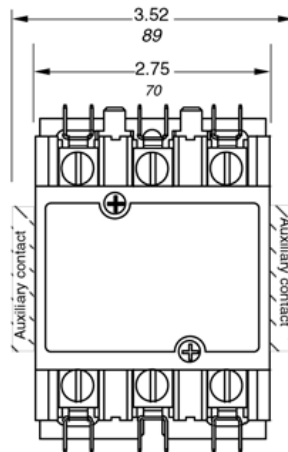
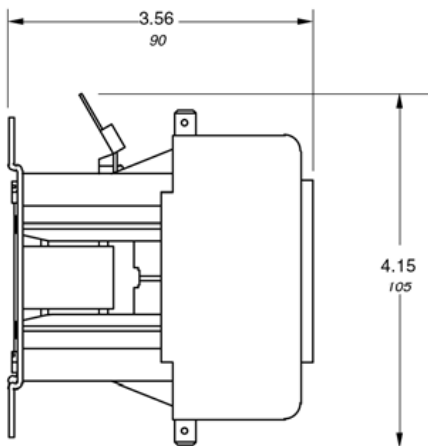

DP75 to DP90, 3 poles

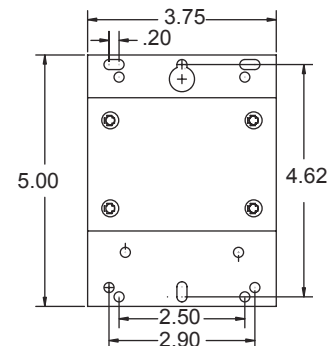
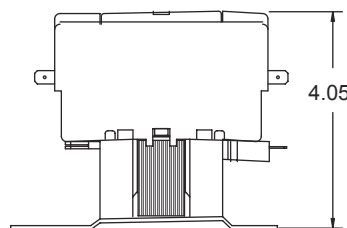
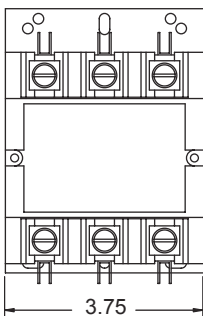

Approximate dimensions

Terminals

Standard on DP 20 to DP30

Standard on DP40

Standard on DP 60

Standard on DP 90

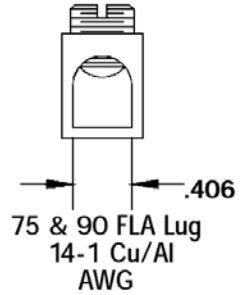
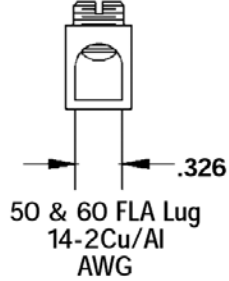
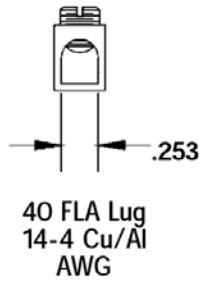

Notes

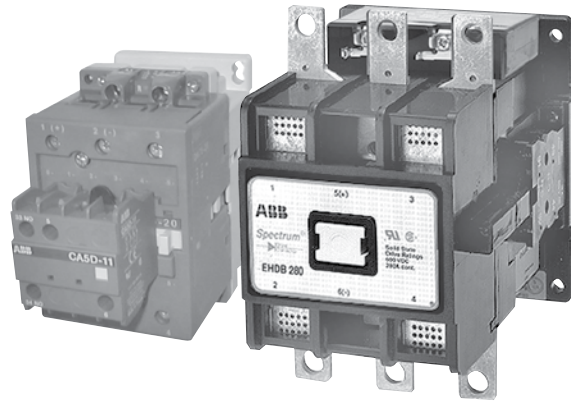

Description

Drive contactors are specifically designed for use with solid state D.C. adjustable speed drive systems. In drive applications, the contactor is not required to make or break the load during normal operation. The N.C. contact is used for dynamic braking applications. EHDB contactors are provided less terminal lugs. Additionally, EHDB contactors carry elevator service ratings.

Type DA

- 60 A continuous
- 160...300V DC dynamic braking
- Double-break contacts
- Identical H/W dimensions to standard A-line
- DIN rail and panel mount
- cULus Recognized – File # E312527
- Motor Controllers, Magnetic – Component (NLDX2, NLDX8)

Type EHDB

- 220..960 A continuous
- 600V DC dynamic braking
- Double-break contacts with magnetic arc chutes
- Elevator service rated
- Replacement parts available
- cULus Recognized – File # E36588
- Motor Controllers, Magnetic – Component (NLDX2, NLDX8)

EHDB, DA75 2- & 3-pole, non-reversing

For DC drive applications up to 960 A
AC or DC operated coils



DA75-21A-11-84



EHDB280C-1L



EHDB520C2P-1L

Electrical ratings

DC continuous current (A)	N.O. power poles DC make/break	N.C. dynamic braking pole			Standard auxiliary contacts		Catalog number 2-pole 2 N.O.	Catalog number 3-pole 2 N.O. + 1 N.C.
		DC make	DC break		N.O.	N.C.		
500V	500V	500V	150V	300V	N.O.	N.C.		
Type DA75, 2 & 3 pole								
60	60	-	-	-	1	1	DA75-20-11-Δ	-
60	60	90	55	-	2	1	-	DA75-21-21-Δ
60	60	90	-	55	1	1	-	DA75-21A-11-Δ

Note: DA75 2 & 3 pole contactors are equipped with polarity-dependent N.O. contacts.

DC continuous current (A)	N.O. power poles DC make/break	N.C. dynamic braking pole		Standard auxiliary contacts		Catalog number 2-pole 2 N.O.	Catalog number 3-pole 2 N.O. + 1 N.C.
		DC make	DC break	N.O.	N.C.		
600V	600V	600V	300V	N.O.	N.C.		
Type EHDB, 2 & 3 pole							
220	333	450	285	1	1	EHDB220C2P-ΔL	EHDB220C-ΔL
280	425	565	363	1	1	EHDB280C2P-ΔL	EHDB280C-ΔL
360	556	728	472	1	1	EHDB360C2P-ΔL	EHDB360C-ΔL
520	780	1040	680	1	1	EHDB520C2P-ΔL	EHDB520C-ΔL
650	975	1300	850	1	1	EHDB650C2P-ΔL	EHDB650C-ΔL
800	1200	1600	1050	1	1	EHDB800C2P-ΔL	EHDB800C-ΔL
960	1440	1920	1250	1	1	EHDB960C2P-ΔL	EHDB960C-ΔL

Note: The polarity of the N.C. dynamic braking pole must be respected; 5/L2 (+) – 6/T2 (-).

Coil voltage selection chart (Δ)

Rated control circuit voltage U _c	DA75	EHDB220... EHDB360	EHDB520... EHDB960
24V/50	81	N	-
24V/60	81	F	-
24V DC	-	Y	Y
48V/60	83	G	-
48V DC	-	W	W
110/50, 110...120/60	84	1	1
125V DC	-	Q	Q
208V/60	34	B	B
220V DC	-	R	R
240V/60	80	2	2
277V/60	42	C	C
480V/60	51	4	4
600V/60	55	6	6

Example:
24V DC input voltage: EHDB280C-YL
120V AC input voltage: DA75-21-21-84

EHDB, DA75 2 & 3 pole, mechanically-interlocked DC drive applications up to 960 A AC or DC operated coils

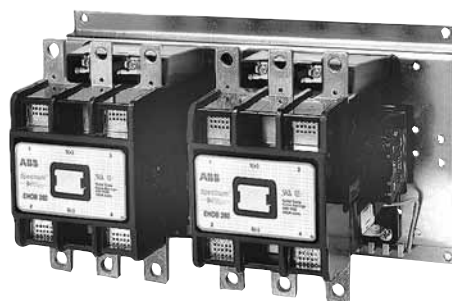

EHDB280M-1L

Electrical ratings

2 & 3 pole mechanically interlocked

DC continuous current (A)	N.O. power poles	N.C. dynamic braking pole		Standard auxiliary contacts		Catalog number 2-pole 2 N.O.	Catalog number 3-pole 2 N.O. + 1 N.C.
	DC make/break	DC make	DC break	N.O.	N.C.		
500V	500V	500V	150V	300V	N.O.	N.C.	
Type DA75, 2 & 3 pole							
60	60	-	-	-	1	1	DA75M-20-11-Δ
60	60	90	-	55	1	1	-
							DA75M-21A-11-Δ

Note: DA75 2 & 3 pole contactors are equipped with polarity-dependent N.O. contacts.

DC continuous current (A)	N.O. power poles	N.C. dynamic braking pole		Standard auxiliary contacts		Catalog number 2-pole 2 N.O.	Catalog number 3-pole 2 N.O. + 1 N.C.
	DC make/break	DC make	DC break	N.O.	N.C.		
600V	600V	600V	300V		N.O.	N.C.	
Type EHDB, 2 & 3 pole							
220	333	450	285	1	1	EHDB220M2P-ΔL	EHDB220M-ΔL
280	425	565	363	1	1	EHDB280M2P-ΔL	EHDB280M-ΔL
360	556	728	472	1	1	EHDB360M2P-ΔL	EHDB360M-ΔL
520	780	1040	680	1	1	EHDB520M2P-ΔL	EHDB520M-ΔL
650	975	1300	850	1	1	EHDB650M2P-ΔL	EHDB650M-ΔL
800	1200	1600	1050	1	1	EHDB800M2P-ΔL	EHDB800M-ΔL
960	1440	1920	1250	1	1	EHDB960M2P-ΔL	EHDB960M-ΔL

Note: The polarity of the N.C. dynamic braking pole must be respected; 5/L2 (+) – 6/T2 (-).

Coil voltage selection chart (Δ)

Rated control circuit voltage U_c	DA75	EHDB220... EHDB360	EHDB520... EHDB960
24V/50	81	N	-
24V/60	81	F	-
24V DC	-	Y	Y
48V/60	83	G	-
48V DC	-	W	W
110/50, 110...120/60	84	1	1
125V DC	-	Q	Q
208V/60	34	B	B
220V DC	-	R	R
240V/60	80	2	2
277V/60	42	C	C
480V/60	51	4	4
600V/60	55	6	6

Example:

24V DC input voltage: EHDB280M-YL

120V AC input voltage: DA75M-21A-11-84

Replacement parts



EHDRC280-1

Coils

	Contactor type	Catalog number
	DA75 EHD220, EHD280 EHD350	ZA75-Δ ① EHDRC280-Δ EHDRC360-Δ
	Withdrawable type	
	EHDB220, EHDB280 EHDB360	EHDBRC280-Δ EHDBRC360-Δ
	EHDB520, EHDB650 EHDB800, EHDB960	EHDBRC650-Δ EHDBRC960-Δ

Δ Substitute the Δ for a coil voltage suffix found in the Coil Voltage Selection Chart. EHDB coils can be used as replacement parts in EHD contactors.

Coil voltage selection chart – DA contactors ①

Hz	Cntr type	Volts														
		12	24	48	110	120	125	208	220	240	277	380	415	440	480	500
60	A	81	83	84	84		34	36	80	42		86	86	51	53	55
50	A	81	83	84				80				85	86			55

NOTE: DC coils are available for DA75 contactors only.

Coil voltage selection chart – EHDB contactors

	Volts														
	24	48	110	120	125	208	220	240	277	380	415	440	480	500	600
60	F	G		1		B	2	2	C				3	4	6
50	N		1				J			3	4			6	
DC	Y	W	P		Q		R								

NOTE: For other voltages, consult factory. • 24VAC coils are not available for sizes EHDB520 – EHDB960. • 48VAC coils are not available for sizes EHDB520 – EHDB960. For these 24V and 48V applications, use an interposing control relay. • 12VDC coils are not available for EHDB520 – EHDB960.

Arc shields

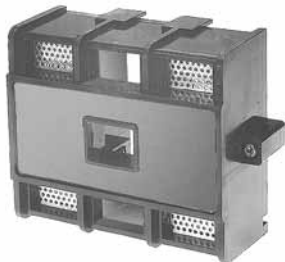

EHDBAS280

	Contactor size	Catalog number
3 Pole	EHDB220	EHDBAS220
	EHDB280	EHDBAS280
	EHDB360	EHDBAS360
	EHDB520	EHDBAS520
	EHDB650	EHDBAS650
	EHDB800	EHDBAS800
	EHDB960	EHDBAS960
2 Pole	EHDB220	EHDBAS220-2
	EHDB280	EHDBAS280-2
	EHDB360	EHDBAS360-2
	EHDB520	EHDBAS520-2
	EHDB650	EHDBAS650-2
	EHDB800	EHDBAS800-2
	EHDB960	EHDBAS960-2

Auxiliary contact blocks – EHDB220 to EHDB960

Contactor size	Description	Terminal markings		Catalog number	
EHDB130 to EHDB960	Standard 1 N.O. & 1 N.C.	13, 14	21, 22	CAL16-11A	L
	Standard 1 N.O. & 1 N.C.	43, 44	31, 32	CAL16-11B	R
EHDB960	Standard 1 N.O. & 1 N.C.	53, 54	61, 62	CAL16-11C	L
	Late break 1 N.O. & 1 N.C.	83, 84	71, 72	CAL16-11D	R
	Late break 1 N.O. & 1 N.C.	47, 48	35, 36	CAL16-11E	L,R

EHDB130 to EHDB960 contactors are provided with a 1 N.O. & 1 N.C. auxiliary contact block mounted on each contactor. One additional 1 N.O. & 1 N.C. auxiliary contact block can be mounted on the left side of the contactor and two additional 1 N.O. & 1 N.C. contact blocks can be mounted on the right side.

Positive driven action auxiliary contact blocks – EHDB220 to EHDB360

Contactor size	Description	Terminal markings		Catalog number	
EHDB220 to EHDB360	Standard 1 N.O. & 1 N.C.	13, 14	21, 22	CAL16-11A	L
	Standard 1 N.O. & 1 N.C.	43, 44	31, 32	CAL16-11B	R

Only one of these auxiliary contact blocks can be mounted on each side of the contactor. They fulfil the mirror contacts IEC609 47-1 Annex F, positive driven action IEC609 47-1, Chapter 4. They also fulfil the elevator standard ASME A17-1-2000.

① For other voltages, see page 1.26.

Replacement parts

Contact kits – 2 Pole, N.O.



EHDBCK280-2

Contactor size	Catalog number
DA75	ZL75
EHDB220	EHDBCK220-2
EHDB280	EHDBCK280-2
EHDB360	EHDBCK360-2
EHDB520	EHDBCK520-2
EHDB650	EHDBCK650-2
EHDB800	EHDBCK800-2
EHDB960	EHDBCK960-2

N.C. DB Kit only



EHDBCK280-NC

Contactor size	Contact rating	Auxiliary interlocks	Catalog number
DA75	55A/160V; 28A/300V	1 NO	CA5D-11
DA75	300V	—	CA5D-01
EHDB220	300V	—	EHDBCK220-NC
EHDB280	300V	—	EHDBCK280-NC
EHDB360	300V	—	EHDBCK360-NC
EHDB520	300V	—	EHDBCK520-NC
EHDB650	300V	—	EHDBCK650-NC
EHDB800	300V	—	EHDBCK800-NC
EHDB960	300V	—	EHDBCK960-NC

Lug kits – 2 & 3 Pole

Contactor size	Wire size	Catalog number
EHDB220 – EHDB280	6-250	EHTK210
EHDB360 – EHDB650	4-500	EHTK550N
EHDB800	(2) 4-500	EHTK700
EHDB960	(3) 2-600	EHTK800

Technical data

Type DA

Contactor		DA75-21	DA75-21A
Center pole			
N.C. Pole, 150V Make	Max. Amps	90	—
N.C. Pole, 150V Break	Max. Amps	55	—
N.C. Pole, 300V Make	Max. Amps	—	90
N.C. Pole, 300V Break	Max. Amps	—	55
DC rating			
Maximum thermal current	A	60	60
Peak interrupting current	A	90	90
Connectable wire size			
Main poles with lugs		8 – 1	8 – 1
Auxiliary contacts, min/max		18 – 10	18 – 10
Main contacts (contactor life)			
Mechanical endurance @ no load	mil.	5	5
Electrical endurance, main poles	mil.	1.5	1.5
Frequency of operations per hour	600	600	600
Auxiliary contacts			
NEMA rating		A600	A600
AC rated voltage	V	600	600
AC thermal rated current	A	10	10
AC maximum making	VA	7200	7200
AC maximum breaking	VA	720	720
NEMA rating		P600	P600
DC rated voltage	V	600	600
DC thermal rated current	A	5	5
DC maximum make-break	A	0.2	0.2
Min. breakdown AC RMS voltage between live parts and ground	V	2200	2200
Minimum permissible load, 17V	A	0.005	0.005
Max. wire size on terminals @ 2/term		10 AWG	10 AWG
Max. operations per hour		600	600
Min. expected mechanical life	mil.	10	10
Min. expected electrical life	mil.	2	2
Coil operating data			
AC power consumption			
Inrush 60 Hz	VA	200	200
Holding 60 Hz	VA	20	20
Holding 60 Hz	W	5.5	5.5
AC operating time (in milliseconds)			
Closing time	ms	20 – 25	20 – 15
Opening time	ms	10 – 15	10 – 15
General data			
Approximate weight	lbs	2.4	2.4
Temperature limits			
Maximum operating temperature	°C	50	50
Minimum operating temperature	°C	-25	-25
Minimum storage temperature	°C	-40	-40
Maximum storage temperature	°C	70	70
Min. breakdown AC RMS voltage	V	2200	2200
Operating altitude			
Maximum operating altitude	feet	10,000	10,000

Technical data

Type EHDB

Contactor model number		EHDB220	EHDB280	EHDB360	EHDB520	EHDB650	EHDB800	EHDB960
N.O. poles, Amps	600 VDC	220	280	360	520	650	800	960
N.C. pole, 600V Make	Max. amps	456	565	728	1040	1300	1600	1920
N.C. pole, 300V Break	Max. amps	285	363	472	680	850	1050	1250
Connectable wire size								
Main poles with lugs		8 – 30	5 – 250 kcmils	4 – 500 kcmils	(2) 4 – 500 kcmils	(2) 4 – 500 kcmils	(3) 2 – 600 kcmils	(3) 2 – 600 kcmils
Auxiliary contacts	min./max.	16/10	16/10	16/10	16/10	16/10	16/10	16/10
DC rating information								
	No. Poles							
Peak interrupting current	A	330	420	540	780	975	1200	1440
Maximum thermal current	A	220	280	360	520	650	800	960
Main contacts (contactor life)								
Mechanical endurance @ no load	mil.	5	5	5	5	5	5	5
Electrical endurance	mil.	1.5	1.5	1.5	1.5	1.5	1.5	1.5
Frequency of operations	per hour	300	300	300	300	300	300	300
Auxiliary contacts								
NEMA rating		A600	A600	A600	A600	A600	A600	A600
AC rated voltage	V	600	600	600	600	600	600	600
AC thermal rated current	A	10	10	10	10	10	10	10
AC maximum making	VA	7200	7200	7200	7200	7200	7200	7200
AC maximum breaking	VA	720	720	720	720	720	720	720
NEMA rating								
DC rated voltage	V	600	600	600	600	600	600	600
DC thermal rated current	A	5	5	5	5	5	5	5
DC maximum make-break	A	0.2	0.2	0.2	0.2	0.2	0.2	0.2
Min. breakdown AC RMS voltage between live parts and ground		2200	2200	2200	2200	2200	2200	2200
Min. permissible load, 17V	A	0.005	0.005	0.005	0.005	0.005	0.005	0.005
Expected mechanical life	mil.	5	5	5	5	5	5	5
Max. operations per hour		300	300	300	300	300	300	300
Coil operating data								
AC power consumption								
Inrush 60 Hz	VA	900	900	1200	2900	2900	400	4000
Holding 60 Hz	VA	52	52	65	105	105	140	140
Holding 60 Hz	W	18	18	22	44	44	60	60
DC power consumption								
Inrush	W	500	500	630	800	800	1100	1100
Holding	W	3.6	3.6	4	20	20	20	20
AC operating time								
Closing time	ms	20 – 30	20 – 30	20 – 30	30 – 50	30 – 50	30 – 50	30 – 50
Opening time	ms	7 – 15	7 – 15	7 – 15	10 – 20	10 – 20	10 – 20	10 – 20
DC operating time								
Closing time	ms	30 – 40	30 – 40	30 – 40	60 – 80	60 – 80	60 – 80	60 – 80
Opening time	ms	27 – 37	27 – 37	27 – 37	10 – 20	55 – 75	55 – 75	55 – 75
General data								
Approximate weight	lbs	9.2	9.2	13	27.3	27.3	37	38
Temperature limits								
Maximum operating temperature	°C	70	70	70	70	70	70	70
Minimum operating temperature	°C	-40	-40	-40	-40	-40	-40	-40
Minimum storage temperature	°C	-50	-50	-50	-50	-50	-50	-50
Maximum storage temperature	°C	70	70	70	70	70	70	70
Min. Breakdown AC RMS Voltage		2200	2200	2200	2200	2200	2200	2200
Operating altitude								
Maximum operating altitude	feet	10,000	10,000	10,000	10,000	10,000	10,000	10,000

Approximate dimensions

Type DA, 2 & 3 pole

DA75

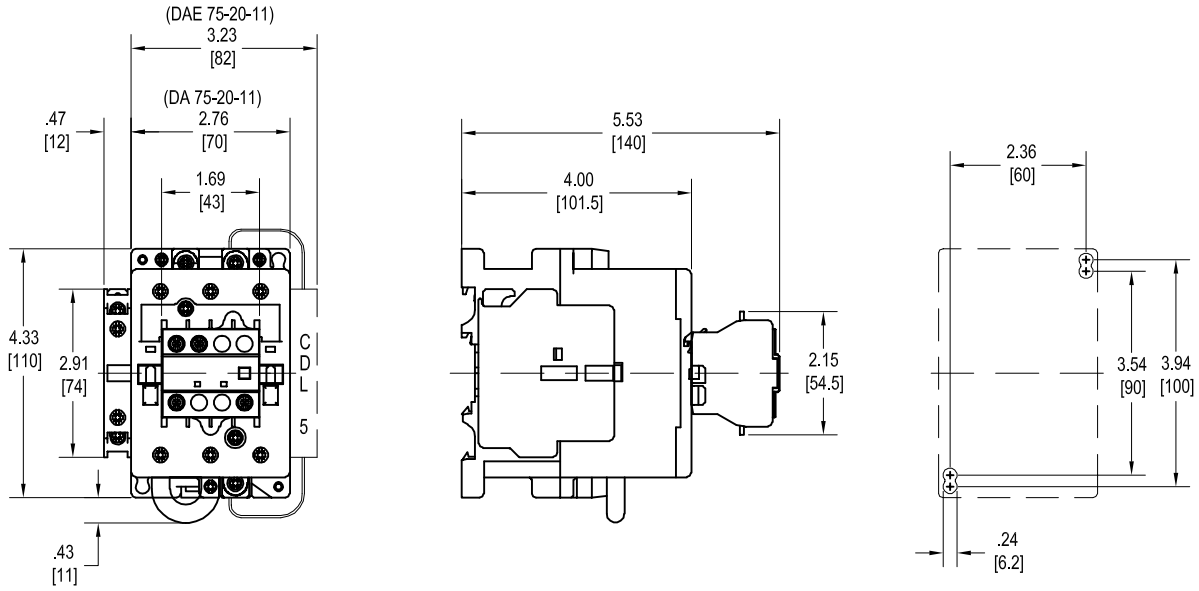

DA75M

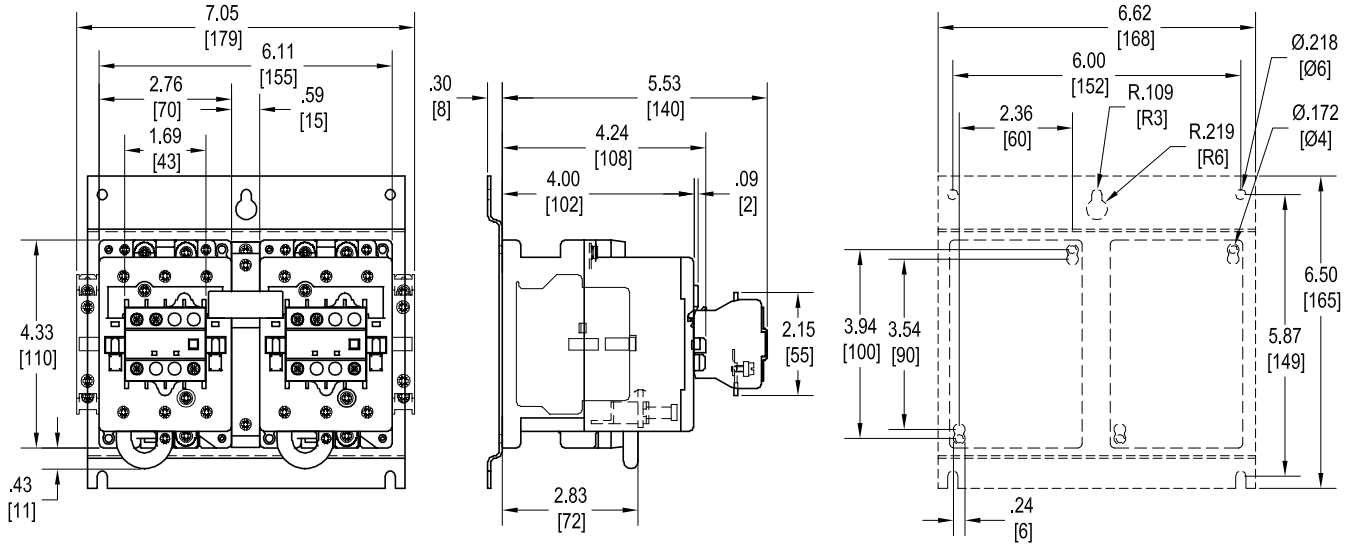

Approximate dimensions

Type EHDB, 2 & 3 pole

Mounting positions

EHDB220 – EHDB960

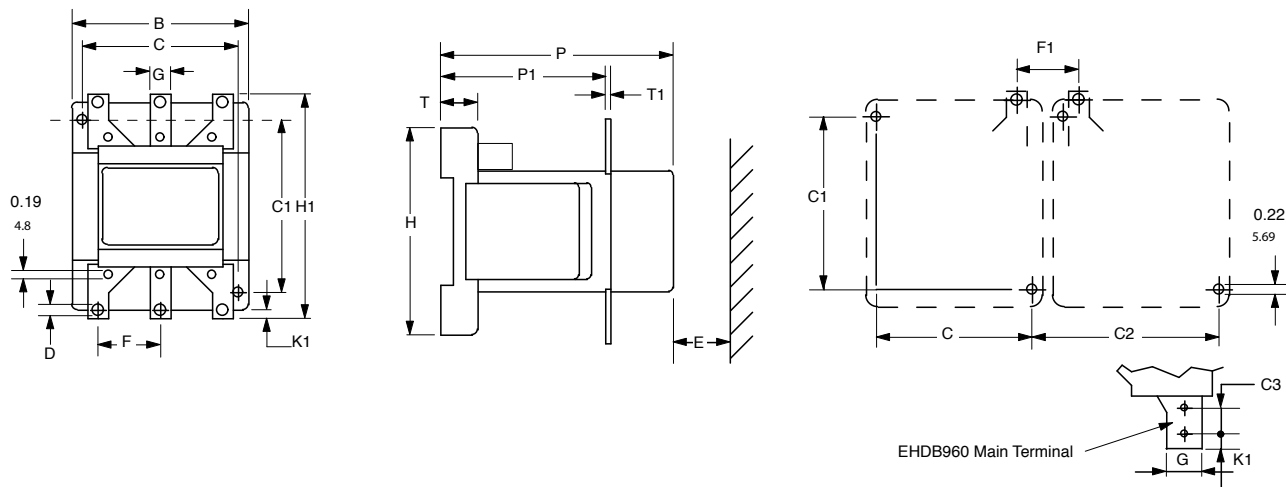

DIM.	B			B2	C	C1				C2	E	D	F	G	H	H1	K1	P	P1	T	T1	C3	
	1, 2	3	4	①		②	③	④															
	Aux. contact block																						
EHDB220in mm	5.35 136	5.83 148	6.30 160	6.46 164	4.72 120	5.51 140	5.39 137	5.39 137	5.87 149	6.34 161	0.59 15	0.24 6	1.77 45	0.79 20	6.14 156	7.79 198	0.39 10	6.65 169	4.06 103	0.41 10.5	0.20 5	—	—
EHDB280in mm	5.35 136	5.83 148	6.30 160	6.46 164	4.72 120	5.51 140	5.39 137	5.39 137	5.87 149	6.34 161	0.59 15	0.24 6	1.77 45	0.79 20	6.14 156	7.79 198	0.39 10	6.65 169	4.06 103	0.41 10.5	0.20 5	—	—
EHDB360in mm	6.92 176	7.44 189	7.72 196	8.11 206	6.30 160	5.51 140	7.20 183	7.32 186	7.48 190	7.76 197	1.18 30	0.24 6	2.44 62	0.98 25	6.14 156	8.14 207	0.49 12.5	6.88 175	4.21 107	0.7 19	0.20 5	—	—
EHDB520in mm	7.80 198	8.23 209	8.62 219	8.90 226	6.69 170	7.87 200	7.91 201	7.91 201	8.19 208	8.54 217	1.57 40	0.24 6	2.64 67	0.98 25	8.78 223	10.71 272	0.49 12.5	8.90 226	5.51 140	0.9 23	0.24 6	—	—
EHDB650in mm	7.80 198	8.23 209	8.62 219	8.90 226	6.69 170	7.87 200	7.91 201	7.91 201	8.19 208	8.54 217	1.57 40	0.24 6	2.64 67	0.98 25	8.78 223	10.71 272	0.49 12.5	8.90 226	5.51 140	0.9 23	0.24 6	—	—
EHDB800in mm	9.61 244	9.96 253	10.31 262	10.63 270	8.66 220	7.87 200	9.69 246	9.69 246	10.00 254	10.35 263	1.57 40	0.24 6	3.23 82	1.57 40	8.78 223	11.57 294	0.79 20	8.90 226	5.51 140	0.9 23	0.24 6	—	—
EHDB960in mm	9.61 244	9.96 253	10.31 262	10.63 270	8.66 220	7.87 200	9.69 246	9.69 246	10.00 254	10.35 263	1.57 40	0.24 6	3.23 82	1.57 40	8.78 223	11.57 294	0.79 20	8.90 226	5.51 140	0.9 23	0.24 6	1.36 34.5	—

- ① Minimum dimension
 - ② Makes distance F1 = F
 - ③ Includes space for three auxiliary contact blocks between the contactors.
 - ④ Includes space for four auxiliary contact blocks between the contactors.
 - ⑤ Damping elements are included.
- NOTE: Screw, nut and washer are included for terminal hardware.

Type DA & EHDB mounting positions

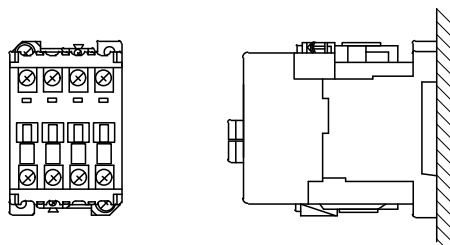

Notes



Lighting contactors A9 – A300

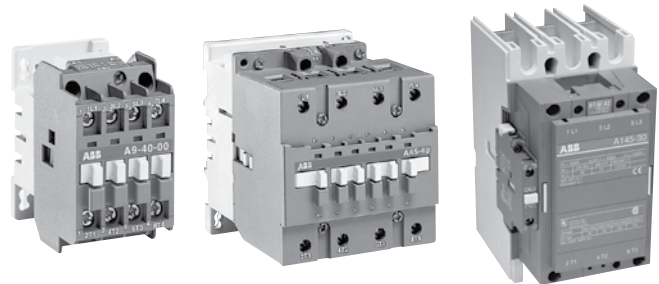

Features

- CE mark
- Compact space saving design
- Standard auxiliary contact configurations:
 - A9 - A40 1 NO or 1 NC
 - A50 - A110 1 NO & 1 NC
- Additional auxiliary contact blocks are available
- Panel mounting with screws or fast, snap-on DIN rail mounting
- Silver alloy double break contact design
- Snap-on front mounted accessories include mechanical latch, pneumatic timer, and 1 & 4 pole auxiliary contact blocks
- Contactors ensure positive safety between their auxiliary contact blocks.
- Easy coil change
- Captive terminal screws
- NEMA, UL, IEC, CSA, VDE and most other international standards
- Touch safe design: All connection terminals are protected against accidental touch
- Terminals supplied open for ease of wiring
- Operates over an extended voltage range of 85% to 110% of rated control voltage
- Screwdriver guide holes
- UL File No: E39231 (A9 - A75); (AE9 - AE75); (AL9 - AL40); (AF50 - AF75)
- UL File No: E36588 (A95 - A110); (AE95 - AE110); (AF145 - AF750)
- CSA File No: LR56745 (A9 - A75); (AE9 - AE75); (AF50 - AF75)
- CSA File No: LR19700 (A95 - A110); (AE95 - AE110); (AF145 - AF750)

Applications

Lighting contactors can be used to control a variety of lighting loads including:

- Tungsten filament lighting loads (incandescent), iodine lamps, quartz-iodine and infrared lamps
- Electric discharge lighting loads (ballast), high intensity discharge (HID), mercury vapor, metal halide and high pressure sodium and fluorescent lamps

Typical applications

- Parking lots
- Industrial plants
- Office buildings
- Theaters and auditoriums
- Stadiums
- Shopping centers
- Airports
- Hospitals
- Transportation lighting
- Institutions

Description

The A-Line lighting contactors are available with or without an enclosure.

- Maximum operating voltage of 600VAC 60Hz
- Includes 3, 4, 8 or 12 pole versions, other versions on request
- Electrically or mechanically held contactors
- IP 20 protection for connection terminals
- Can be mounted onto a mounting plate or a 35 x 7.5mm DIN rail
- UL/CSA Approved

Lighting Contactors

A9 - A300

Electrically & mechanically held



A9-40-00



A45-40-00



A145-30-11

Normally Open Power Poles			Electrically Held			Mechanically Held		
Ballast Amp Rating	Incandescent (Tungsten) Amp Rating	Number of Power Poles	Open Type	UL Type 1 Enclosed		Open Type	UL Type 1 Enclosed	
			Catalog number	Enclosure Size	Catalog number	Catalog number	Enclosure Size	Catalog number
15	15	4	A9-40-00-84	A	A9C4P1-84	A9L-40-00-84	B	A9LC4P1-84
15	15	8	A9-80-00-84	A	A9C8P1-84	A9L-80-00-84	B	A9LC8P1-84
15	15	12	A9-120-00-84	A	A9C12P1-84	A9L-120-00-84	B	A9LC12P1-84
30	20	4	A16-40-00-84	A	A16C4P1-84	A16L-40-00-84	B	A16LC4P1-84
30	20	8	A16-80-00-84	A	A16C8P1-84	A16L-80-00-84	B	A16LC8P1-84
30	20	12	A16-120-00-84	A	A16C12P1-84	A16L-120-00-84	B	A16LC12P1-84
30	30	4	A16-40L-00-84	A	A16C4PL1-84	A16L-40L-00-84	B	A16LC4PL1-84
30	30	8	A16-80L-00-84	A	A16C8PL1-84	A16L-80L-00-84	B	A16LC8PL1-84
30	30	12	A16-120L-00-84	A	A16C12PL1-84	A16L-120L-00-84	B	A16LC12PL1-84
35	35	4	A26-40-00-84	B	A26C4P1-84	A26L-40-00-84	B	A26LC4P1-84
35	35	8	A26-80-00-84	B	A26C8P1-84	A26L-80-00-84	B	A26LC8P1-84
35	35	12	A26-120-00-84	B	A26C12P1-84	A26L-120-00-84	B	A26LC12P1-84
50	50	3	A30-30-10-84	B	A30C3P1-84	A30L-30-10-84	C	A30LC3P1-84
60	60	3	A40-30-10-84	B	A40C3P1-84	A40L-30-10-84	C	A40LC3P1-84
60	60	4	A45-40-00-84	B	A45C4P1-84	A45L-40-00-84	C	A45LC4P1-84
65	65	3	A50-30-00-84	B	A50C3P1-84	A50L-30-00-84	C	A50LC3P1-84
65	65	4	A50-40-00-84	B	A50C4P1-84	A50L-40-00-84	C	A50LC4P1-84
85	85	3	A63-30-00-84	B	A63C3P1-84	A63L-30-00-84	C	A63LC3P1-84
105	105	3	A75-30-00-84	B	A75C3P1-84	A75L-30-00-84	C	A75LC3P1-84
105	105	4	A75-40-00-84	B	A75C4P1-84	A75L-40-00-84	C	A75LC4P1-84
120	120	3	A95-30-00-84	B	A95C3P1-84	---	---	---
200	200	3	A145-30-00-84	E	A145C3P1-84	---	---	---
300	300	3	A210-30-00-84	F	A210C3P1-84	---	---	---
400	400	3	A300-30-00-84	F	A300C3P1-84	---	---	---

Normally Closed Power Poles			Electrically Held			Mechanically Held		
Ballast Amp Rating	Incandescent (Tungsten) Amp Rating	Number of Power Poles	Open Type	UL Type 1 Enclosed		Open Type	UL Type 1 Enclosed	
			Catalog number	Enclosure Size	Catalog number	Catalog number	Enclosure Size	Catalog number
30	20	4	A16-04-00-84	B	A16C4NCP1-84	A16L-04-00-84	B	A16LC4NCP1-84
30	20	8	A16-08-00-84	B	A16C8NCP1-84	A16L-08-00-84	B	A16LC8NCP1-84
30	20	12	A16-012-00-84	B	A16C12NCP1-84	A16L-012-00-84	B	A16LC12NCP1-84

Coil voltage selection

All catalog numbers include a 120VAC coil. To select other coil voltages, substitute the code from the Coil Voltage Selection Chart for the two digits after the last dash in the catalog number.

Ex.: A 240V coil is required for an A75 contactor: A75-30-00-80

Coil voltage selection

Hz	Type	Volts															
		12	24	48	110	120	125	208	220	240	277	380	415	440	480	500	600
60	A		81	83	84	84		34	36	80	42		86	86	51	53	55
50	A		81	83	84				80			85	86			55	

For other voltages, consult factory

Control transformer option

Contactor size	VA rating
A9 - A40	50
A50 - A75	75
A95	100
A145	150
A210 - A300	250

Control transformer voltage selection chart

Hz	Type	Volts			
		208/120	230 - 240/120	460 - 480/120	575 - 600/120
50/60	A	0	7	8	9

For other voltages, consult factory

A9 - A300

Electrically & mechanically held

2 Normally Open & 2 Normally Closed Power Poles			Electrically Held			Mechanically Held		
			Open Type	UL Type 1 Enclosed		Open Type	UL Type 1 Enclosed	
Ballast Amp Rating	Incandescent (Tungsten) Amp Rating	Number of Power Poles	Catalog number	Enclosure Size	Catalog number	Catalog number	Enclosure Size	Catalog number
15	15	2 NO / 2 NC	A9-22-00-84	A	A9C22P1-84	A9L-22-00-84	A	A9LC22P1-84
30	20	2 NO / 2 NC	A16-22-00-84	B	A16C22P1-84	A16L-22-00-84	B	A16LC22P1-84
35	35	2 NO / 2 NC	A26-22-00-84	B	A26C22P1-84	A26L-22-00-84	B	A26LC22P1-84
60	60	2 NO / 2 NC	A45-22-00-84	B	A45C22CP1-84	A45L-22-00-84	C	A45LC22CP1-84
105	105	2 NO / 2 NC	A75-22-00-84	B	A75C22CP1-84	A75L-22-00-84	C	A75LC22CP1-84

NEMA rated

Normally open Power Poles 600 VAC Max.			Electrically held Open type
Ballast Amp Rating	Incandescent (Tungsten) Amp rating	Number of Power poles 1	Catalog number
30	30	3	L30A3010Δ
60	60	3	L60A3010Δ
100	100	3	L100A3000Δ
200	200	3	L200A3000Δ

Control transformer option

Contactor size	VA rating
A9 - A40	50
A50 - A75	75
A95	100
A145	150
A210 - A300	250

Control transformer voltage selection chart

Hz	Type	Volts			
		208/120	230 - 240/120	460 - 480/120	575 - 600/120
50/60	A	0	7	8	9

For other voltages, consult factory

Coil voltage selection

All catalog numbers include a 120VAC coil. To select other coil voltages, substitute the code from the Coil Voltage Selection Chart for the two digits after the last dash in the catalog number.

Ex.: A 240V coil is required for an A75 contactor: A75-30-00-80

Coil voltage selection

Hz	Cntr Type	Volts															
		12	24	48	110	120	125	208	220	240	277	380	415	440	480	500	600
60	A		81	83	84	84		34	36	80	42		86	86	51	53	55
50	A		81	83	84					80			85	86			55

For other voltages, consult factory

Accessories Factory modifications



CAL5-11

CA5-10





WB75-01



RV5/50

Accessories

Auxiliary contact blocks

Mounting on contactors	Positioning	Contacts		Catalog number
				
A 9 ... A 95	Front face	1	-	CA5-10
		-	1	CA5-01
A 9 ... A 40	Front face	3	1	CA5-31M
		2	2	CA5-22M
A 9 ... A 75	Side	1	1	CAL5-11
A 95 ... A 300	Side	1	1	CAL18-11
A145... A 300	Side	1	1	CAL18-11B

Mechanical latch

For contactors	Voltage	Catalog number
A 9 ... A 75	24 ... 28 V a.c./d.c.	WB75A-01
	48 ... 55 V a.c./d.c.	WB75A-03
	110 ... 127V a.c./d.c.	WB75A-04
	230 ... 277 V a.c./d.c.	WB75A-05
	380 ... 440 V a.c./d.c.	WB75A-07
	440 ... 480 V a.c./d.c.	WB75A-08

Surge suppressor, varistor

For contactors	Voltage range	Catalog number
A 9 ... A 110	24 ... 50 V a.c./d.c.	RV5/50
	50 ... 133 V a.c./d.c.	RV5/133
	110 ... 250 V a.c./d.c.	RV5/250
	250 ... 440 V a.c./d.c.	RV5/440

Factory modifications for enclosed contactors

Pilot devices

Description	Suffix code
Selector - 2 position maintained OFF - ON	C
Selector - 3 position maintained HAND OFF - AUTO	D
Pilot light - ON (green)	R

Approximate dimensions

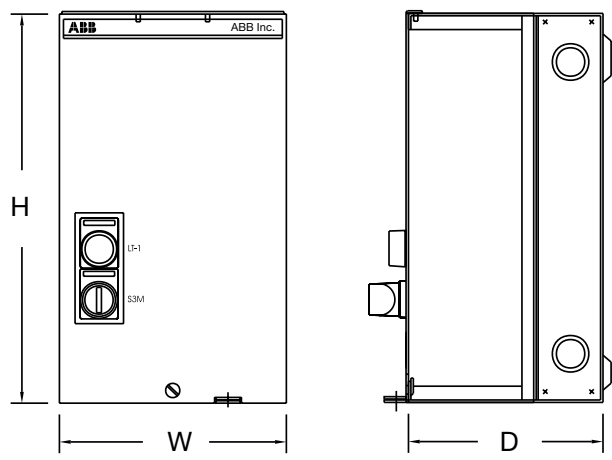

Enclosure dimensions (in)

Type	H	W	D
A	11	6	5
B	13	9	7
C	14	12	8
D	24	12	8
E	30	24	9

Notes

Railway application Contactors



Railway application contactors

Types TBC, TAL & TAE

TNL, ring-tongue termination

1

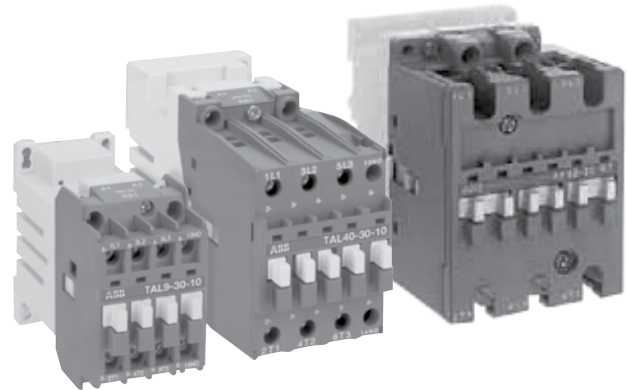

Description

Rolling stock applications necessitate compliance to national and international standards tailored to railway environments (see "Reference Standards" on the following page). In order to improve reliability and durability, most railway applications employ specific connection methods, such as ring-tongue termination.

Coil surge suppression is also popular among rail applications. ABB's AF Series contactors are equipped with integral surge suppression in the form of a free-wheel diode, eliminating the need for additional accessories. AF Series devices are also immune to short time voltage interruption (or voltage dips) up to 20 ms.

Contactors and contactor relays are used in versatile rolling stock applications:

- Lighting
- Heating
- Braking
- Air conditioning
- Ventilation
- Door control

Requirements of railway applications

- Control networks typically utilizing DC (battery source) with wide voltage ranges:
 - 0.7 U_c ... 1.25 U_c (Operating limits included as U_c)
- Wide temperature range: -40 °C... +70 °C
- Shock & vibration withstand
- Fire-retardant / low smoke materials required

Reference standards

The contactor and control relays described in the following pages are in accordance with the following standards:

- IEC 60077-1 and IEC 60077-2 : Railway applications - Electric equipment for rolling stock.
- IEC 61373 : Railway applications - Rolling stock - Shocks and vibration tests.
- NF F 60002 : French standard - Vibration tests.
- IEC 60947-4-1 / EN 60947-4-1 : Low voltage controlgear - Contactors and motor starters.
- IEC 60947-5-1 / EN 60947-5-1 : Low voltage controlgear - Control circuit devices and switching elements.
- NF F 62000 : French standard - Functional tests for French railways (SNCF).

"Fire and Smoke" classification

According to ASTM standards:

ASTM standards, mainly used in North America, device products into two categories:

- For surfaces < 16 inch² the products are tested in accordance with:
 - ASTM E1354 : flammability and visible smoke
- For surfaces > 16 inch² the products are tested in accordance with:
 - E662 (97): density of smoke,
 - E162 (98): flammability of surface and
 - BSS 7239: toxicity of smoke (CO, HF, NO₂, HCl, HCN, SO₂).

Most of contactors, contactor relays and accessories have been tested according to the above standards. Certificates are available on request.

According to NF F standards:

French standards NF F (Normes Francaises Ferroviaires) are mainly used in Europe and Asia.

- NF F 16101: Fire behavior - Material choosing.
- NF F 16102: Fire behavior - Application to electrical equipment.

The contactors and accessories are at severity level 2 or 3 (classification level from 1 to 4) according to flammability (mark l) on the one hand, the opacity and toxicity of smoke (mark F) (CO, CO₂, HCl, HBr, HCN, HF, SO₂) in other hand.

Note: French standards are still used as references in some international railways because they were used for a long time and were alone to qualify the fire and smoke problem. There is no links between ASTM and NFF standards. A plastic material acceptable in NF F frame doesn't mean the acceptability in ASTM frame.

Technical data

Technical data for the following devices is provided in Literature no. 1SBC104032D0201. Please reference this document number at ABB.com to download or contact Technical Support at 1 (888) 385.1221, Option 4

Standard devices, ring-tongue, 3-pole A/L9...A/F75 AC or DC controlled



A26..RT



A50...A75..RT

Electrical ratings

AC general purpose ratings (A)	Maximum motor switching current (A)	AC motor ratings, breaking all lines, three phase, 50/60 Hz (hp)				Standard auxiliary contacts		Catalog number, AC controlled	Catalog number, DC controlled
		200... 208V	220... 240V	440... 480V	550... 600V	NO	NC		
600V	9	2	2	5	7.5	1	-	A93010RT-Δ	AL93010RT-Δ
						-	1	A93001RT-Δ	AL93001RT-Δ
25	11	3	3	7.5	10	1	-	A123010RT-Δ	AL123010RT-Δ
						-	1	A123001RT-Δ	AL123001RT-Δ
30	17	5	5	10	15	1	-	A163010RT-Δ	AL163010RT-Δ
						-	1	A163001RT-Δ	AL163001RT-Δ
40	28	7.5	10	20	25	1	-	A263010RT-Δ	AL263010RT-Δ
						-	1	A263001RT-Δ	AL263001RT-Δ
50	34	10	10	25	30	1	-	A303010RT-Δ	AL303010RT-Δ
						-	1	A303001RT-Δ	AL303001RT-Δ
60	42	10	15	30	40	1	-	A403010RT-Δ	AL403010RT-Δ
						-	1	A403001RT-Δ	AL403001RT-Δ
80	54	15	20	40	50	1	1	A503011RT-Δ	AF503011RT-Δ
						1	1	A633011RT-Δ	AF633011RT-Δ
105	80	25	30	60	75	1	1	A753011RT-Δ	AF753011RT-Δ

Note: devices with ring-tongue termination UL recognized

Coil voltage selection chart (Δ)

Rated control circuit voltage U_c	A9... A75	AL9... AL40	AF50... AF75
12V DC	-	80	80
24V AC	81	-	-
24V DC	-	81	81
20...60V DC	-	-	72
110V/50, 110...120V/60	84	-	-
48...130V AC/DC	-	-	69
100...250V AC/DC	-	-	70
125V DC	-	87	87
220V DC	-	88	88
230...240V/60	80	-	-
240V DC	-	89	89
480V/60	51	-	-
600V/60	55	-	-

Example:

24V DC input voltage: AL303010RT-81

120V AC input voltage: A753011RT-84

Traction-specific, ring-tongue, 3-pole TBC7, TAL9...AF300B DC controlled, standard & ring-tongue termination



TBC7-30



TAL26..RT



TAE50...TAE75..RT



AF210B...AF300B

Electrical ratings

AC general purpose ratings (A)	Maximum motor switching current (A)	AC motor ratings, breaking all lines, three phase, 50/60 Hz (hp)				Standard auxiliary contacts		Catalog number, Standard termination	Catalog number, Ring-tongue termination
		200... 208V	220... 240V	440... 480V	550... 600V	NO	NC		
600V	9.6	2	3	5	5	1	-	TBC7-30-10-Δ	-
						-	1	TBC7-30-01-Δ	-
21	9	2	2	5	7.5	1	-	TAL9-30-10-Δ	TAL9-30-10RT-Δ
						-	1	TAL9-30-01-Δ	TAL9-30-01RT-Δ
25	11	3	3	7.5	10	1	-	TAL12-30-10-Δ	TAL12-30-10RT-Δ
						-	1	TAL12-30-01-Δ	TAL12-30-01RT-Δ
30	17	5	5	10	15	1	-	TAL16-30-10-Δ	TAL16-30-10RT-Δ
						-	1	TAL16-30-01-Δ	TAL16-30-01RT-Δ
40	28	7.5	10	20	25	1	-	TAL26-30-10-Δ	TAL26-30-10RT-Δ
						-	1	TAL26-30-01-Δ	TAL26-30-01RT-Δ
50	34	10	10	25	30	1	-	TAL30-30-10-Δ	TAL30-30-10RT-Δ
						-	1	TAL30-30-01-Δ	TAL30-30-01RT-Δ
60	42	10	15	30	40	1	-	TAL40-30-10-Δ	TAL40-30-10RT-Δ
						-	1	TAL40-30-01-Δ	TAL40-30-01RT-Δ
80	54	15	20	40	50	1	1	TAE50-30-11-Δ	TAE50-30-11RT-Δ
105	80	25	30	60	75	1	1	TAE75-30-11-Δ	TAE75-30-11RT-Δ
150	88	30	30	60	75	1	1	AF95B-30-11-Δ	AF95B-30-11RT-Δ
150	104	30	40	75	100	1	1	AF110B-30-11-Δ	AF110B-30-11RT-Δ
230	130	40	50	100	125	1	1	AF145B-30-11-Δ	AF145B-30-11RT-Δ
250	156	50	60	125	150	1	1	AF185B-30-11-Δ	AF185B-30-11RT-Δ
300	192	60	75	150	200	1	1	AF210B-30-11-Δ	AF210B-30-11RT-Δ
350	248	75	100	200	250	1	1	AF260B-30-11-Δ	AF260B-30-11RT-Δ
400	302	100	100	250	300	1	1	AF300B-30-11-Δ	AF300B-30-11RT-Δ

Note: devices with ring-tongue termination UL recognized

Coil voltage selection chart (Δ)

Rated control circuit voltage U _c	TBC7	TAL9... TAL40	TAE50... TAE75	AF95B... AF300B
17...32V DC	51	51	51	-
24...45V DC	52	52	52	-
20...60V DC	-	-	-	72
36...65V DC	54	54	54	-
42...78V DC	58	58	58	-
50...90V DC	55	55	55	-
48...130V AC/DC	-	-	-	69
77...143V DC	62	62	62	-
90...150V DC	66	66	66	-
100...250V AC/DC	-	-	-	70
152...264V DC	68	68	68	-

Example:
24V DC input voltage: TAL9-30-10-52
120V AC input voltage: AF300B-30-11RT-70

Coil operating limits

For traction-specific catalog numbers starting with "T", the coil operating limits are included in the coil voltage range (U_c min...U_c max.). For AF.B devices, the coil range is nominal with operating limits 15% below and 10% above the range specified.

Traction-specific, ring-tongue, 4-pole & relays

TBC7, TAL9...TAE75, TNL

DC controlled



TBC7-30

TAL26-40..RT

TAE50-40...TAE75-40..RT

TNL80E

4-pole contactors – Electrical ratings

AC general purpose ratings (A)	Main (power) pole Configuration		Standard auxiliary contacts		Catalog number, Standard termination	Catalog number, Ring-tongue termination
	NO	NC	NO	NC		
600V	NO	NC	NO	NC	TBC7-40-00-Δ	-
16	4	-	-	-	TBC7-22-00-Δ	-
	2	2	-	-	TAL9-40-00-Δ	TAL9-40-00RT-Δ
21	4	-	-	-	TAL9-22-00-Δ	TAL9-22-00RT-Δ
	2	2	-	-	TAL16-40-00-Δ	TAL16-40-00RT-Δ
30	4	-	-	-	TAL16-22-00-Δ	TAL16-22-00RT-Δ
	2	2	-	-	TAL26-40-00-Δ	TAL26-40-00RT-Δ
40	4	-	-	-	TAL26-22-00-Δ	TAL26-22-00RT-Δ
	2	2	-	-	TAL45-40-00-Δ	TAL40-40-00RT-Δ
65	4	-	-	-	TAE50-40-00-Δ	TAE50-40-00RT-Δ
80	4	-	-	-	TAE75-40-00-Δ	TAE75-40-00RT-Δ
105	4	-	-	-		

Note: devices with ring-tongue termination UL recognized

Control relays

Pilot duty ratings	Number of contacts				Catalog number, Standard termination	Catalog number, Ring-tongue termination
	1st stack		2nd stack			
	NO	NC	NO	NC		
A600, Q300	2	2	-	-	TNL22E-Δ	TNL22ERT-Δ
	3	1	-	-	TNL31E-Δ	TNL31ERT-Δ
	4	-	-	-	TNL40E-Δ	TNL40ERT-Δ
	4	-	-	4	TNL44E-Δ	TNL44ERT-Δ
	4	-	2	2	TNL62E-Δ	TNL62ERT-Δ
	4	-	4	-	TNL80E-Δ	TNL80ERT-Δ

Note: devices with ring-tongue termination UL recognized

Coil voltage selection chart (Δ)

Rated control circuit voltage U_c	TBC7	TAL9... TAL40	TAE50... TAE75	AF95B... AF300B
17...32V DC	51	51	51	51
24...45V DC	52	52	52	52
36...65V DC	54	54	54	54
42...78V DC	58	58	58	58
50...90V DC	55	55	55	55
77...143V DC	62	62	62	62
90...150V DC	66	66	66	66
152...264V DC	68	68	68	68

Example:

24V DC input voltage: TAL9-22-00-52

120V AC input voltage: TAE75-40-00RT-62

Coil operating limits

For traction-specific catalog numbers starting with "T", the coil operating limits are included in the coil voltage range (U_c min... U_c max.).

Load / supply requirements

4-pole devices can be utilized for controlling either 2 separate loads from 2 separate supplies, or 2 separate loads from 1 supply. These devices are not suitable for controlling 1 load from 2 separate supplies. There is no mechanical overlapping (NO poles will break before NC poles make).

Accessories

Devices in this section of the catalog utilize the same accessories as ABB's standard across-the-line motor switching devices. Please see the below page references for accessories:

Accessory type	Page reference
Surge suppressors	1.52...1.53
Mechanical / electrical interlocks	1.57
Electronic timers	1.59
Replacement coils	1.73

DC Circuit switching Contactors



DC Circuit switching contactors

Up to 2050A, 1000V DC

Type GA/E, GAF, AF

1

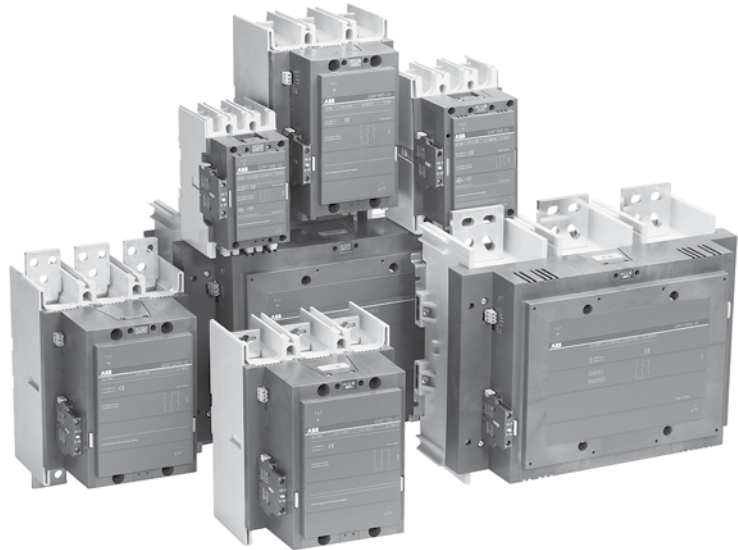

Description

The new GAF range contactors are the latest addition to ABB's well established A/AF range. This further extends our offering of contactors for DC switching at voltages up to 1000 V DC. The GAF contactors utilize all the well known features of the existing A/AF range such as modern and compact design. In addition all the benefits from the AF coil technology and reliability of a proven contactor design. These contactors are rated for DC-1 or DC general purpose applications according to IEC 1000V DC or cULus 600V DC. The new GAF contactors share the external dimensions of its corresponding standard AF contactor.

Applications

- Solar / Photovoltaic power
- Traction / rolling-stock
- Power distribution
- Switchgear
- Battery systems
- Telecom

Type GA / GAE

- DC general use up to 1000V DC, 35A
- AC or DC input voltages
- Pre-wired 3-poles-in-series
- Permanent magnets for high DC breaking
- cULus Listed – File # E319322
 - Switches, Industrial Control (NRNT, NRNT7)

Type AF / GAF

- DC general use up to 600V, 1900A
- DC-1 up to 1000V DC, 2050A
- Electronic AC/ DC coil input voltages
- PLC interface (GAF460...GAF2050)
- Series busbar kits available
- Permanent magnets for high DC breaking
- GAF185...GAF300 cULus Listed – File # E73397
 - Switches, Industrial Control (NRNT, NRNT7)
- GAF460...GAF2050 IEC/EN only
- AF145...AF2650 cULus Listed – File # E73397
 - Switches, Industrial Control (NRNT, NRNT7)

GA75 - GAE75

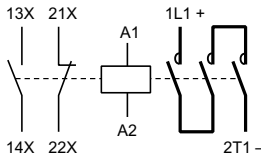
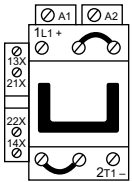
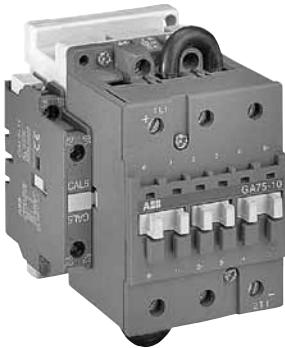

GA75-10-00-84

Electrical ratings

UL/CSA DC general use (A)			IEC / EN DC-1, $\theta \leq 40^\circ$ (A)			Standard auxiliary contacts		Catalog number
440V	600V	1000V	440V	600V	1000V	N.O.	N.C.	
100	75	35	100	75	35	-	-	GA75-10-00-Δ
100	75	35	100	75	35	1	1	GAE75-10-11-Δ

Rated insulation voltage $U_i = 1000V$ d.c. according to IEC 947-4-1.
Maximum switching frequencies: 300 operating cycles/

Additional IEC/EN electrical ratings for GA/E75

Utilization category	Maximum voltage	Rated operational current I_n (A)
DC-3	440V	85
DC-5	220V	85
	440V	35

Coil voltage selection chart (Δ)

Hz	Cntr type	Volts															
		12	24	48	110	120	125	208	220	240	277	380	415	440	480	500	600
60	GA		81	83	84	84		34	75	80	42	48	86	86	51	53	55
50	GA		81	83	84			80				85	86			55	
DC	GAE	80	81	83	86		87		88	89							

For other voltages, see page 1.35.

Accessories

Standard **A** and **AE 40 - 75** contactor accessories are suitable for **GA75** and **GAE75** contactors. Coils are the standard coils for **A** and **AE50 - 75** contactors. Contacts cannot be changed.

Wiring diagrams

In D.C. circuits, the source to earth (or frame) connection mode is an important element.

Three modes are mainly used:

- A** – insulated source, i.e. unearthed (or not connected to the frame).
- B** – source earthed via its central point.
- C** – source earthed via one of its outer poles.

Modes **A** and **B** do not impose any constraints with regard to the distribution of the contactor poles between the two source/load connecting branches. Mode **C** requirements are therefore suitable for modes **A** and **B**.

For mode **C**, all the poles necessary for breaking must be installed in series between the load and the ungrounded source polarity. We recommend this solution for all connection modes.

The above provisions relate to power circuit switching, the SCPD (Short-Circuit Protection Device) must comply with protection rules.

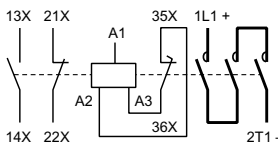
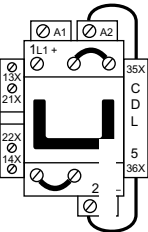
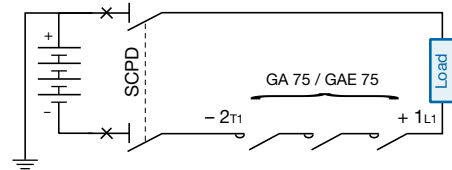
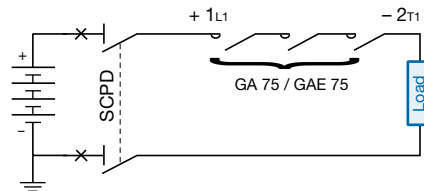

GAE75-10-00-84

GAF185 - GAF2050

DC circuit switching GAF & AF

3 contacts in series

GAF - 1000 V DC max. (IEC)



GAF185
AF145, AF185



GAF300
AF210 ... AF300



GAF460
AF400, AF460



GAF750, GAF1250
AF580 ... AF1250



GAF1650, GAF 2050
AF1350 ... AF2050

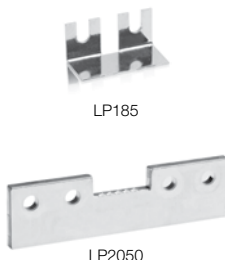

LP185

LP2050

L/R 1 ms, air temperature close to contactor					Catalog number	Reference code	Pkg qty	Weight (1 pce) kg
40 °C	55 °C	60 °C	65 °C	70 °C				
A								
275	250	230	205	180	GAF185-10-11-Δ	1SFL497025RΔ11		3.60
500	400	375	350	325	GAF300-10-11-Δ	1SFL557025RΔ11		6.20
700	600	560	520	480	GAF460-10-11-Δ	1SFL597025RΔ11		12.00
1050	875	800	760	720	GAF750-10-11-Δ	1SFL637025RΔ11		15.00
1250	1040	970	920	875	GAF1250-10-11-Δ	1SFL647025RΔ11		16.00
1650	1450	1380	1325	1270	GAF1650-10-11-Δ	1SFL677025RΔ11		35.00
2050	1750	1650	1575	1500	GAF2050-10-11-Δ	1SFL707025RΔ11		35.00

GAF & AF - 600 V DC max. (UL/CSA) & 850...1000 V DC max. (IEC)

UL/CSA general use, 40 °C			IEC DC-1, 40 °C			Catalog number	Reference code	Pkg qty	Weight (1 pce) kg
A			A						
250			250			GAF185-10-11-Δ	1SFL497025RΔ11		3.60
400			500			GAF300-10-11-Δ	1SFL557025RΔ11		6.20
Use GAF185 - GAF300			See next page for IEC data at various voltages.			AF145-30-11-Δ	1SFL477001RΔ11		3.60
						AF185-30-11-Δ	1SFL497001RΔ11		3.60
						AF210-30-11-Δ	1SFL517001RΔ11		6.20
						AF260-30-11-Δ	1SFL537001RΔ11		6.20
						AF300-30-11-Δ	1SFL597001RΔ11		6.20
						AF400-30-11-Δ	1SFL637001RΔ11		12.00
						AF460-30-11-Δ	1SFL597001RΔ11		12.00
						AF580-30-11-Δ	1SFL617001RΔ11		15.00
						AF750-30-11-Δ	1SFL637001RΔ11		15.00
						AF1250-30-11-Δ	1SFL647001RΔ11		16.00
1350					AF1350-30-11-Δ	1SFL657001RΔ11		34.00	
1900					AF1650-30-11-Δ	1SFL677001RΔ11		35.00	
					AF2050-30-11-Δ	1SFL707001RΔ11		35.00	

Connection bar for contactor ①

GAF185, AF145, AF185	LP185	1SFN074712R1000	2	0.30
GAF300, AF210 ... AF300	LP300	1SFN075112R1000	2	0.40
GAF460, AF400, AF460	LP460	1SFN075712R1000	4	0.55
GAF750, AF580, AF750	LP750	1SFN076112R1000	4	0.95
GAF1250, AF1250	LP1250	1SFN076412R1000	2	1.90
GAF1650, GAF2050, AF1350, AF1650, AF2050	LP2050	1SFN076512R1000	4	2.90

① Not included with the contactor; connection diagrams must be respected

Auxiliary contact blocks, low energy microswitch 0.1 A, N.O or N.C.

AF145...AF2050	N.C.	CEL18-01	1SFN010716R1001		0.05
GAF185...GAF2050	N.O.	CEL18-10	1SFN010716R1010		0.05

AC / DC coils with electronic coil interface

Contactors GAF185 ... GAF300, AF145 ... AF300

Voltage	Voltage	Code	
V - 50/60Hz	V - DC	Δ	Δ
—	20 ... 60	7	2
48 ... 130	48 ... 130	6	9
100...250	100 ... 250	7	0

Contactors GAF460 ... GAF1250, AF400 ... AF1250

Voltage	Voltage	Code	
V - 50/60Hz	V - DC	Δ	Δ
—	24 ... 60	6	8
48 ... 130	48 ... 130	6	9
100 ... 250	100 ... 250	7	0
250 ... 500	250 ... 500	7	1

Contactors GAF1650, GAF2050, AF1350, AF1650, AF2050

100 ... 250	100 ... 250	7	0
-------------	-------------	---	---

Technical data

DC switching ratings AF contactors

IEC

		AF145	AF185	AF210	AF260	AF300	AF400	AF460	AF580	AF750	AF1250	AF1350	AF1650	AF2050
Utilization category DC-1		A	A	A	A	A	A	A	A	A	A	A	A	A
Contacts in series	L/R 1 ms													
1 contact	110 V						600	700	800	1050				
2 contacts	110 V	250	275	350	400	450	600	700	800	1050				
3 contacts	220 V	250	275	350	400	450	600	700	800	1050	1250	1350	1650	2050
3 contacts	600 V						600	700	800	1050	1250	1350	1650	2050
3 contacts	850 V								800	1050	1250	1350	1650	2050
Conductor cross-sectional area	mm ²	120	150	185	240	300 ¹⁾	2x185	2x240	2 x 50x8 ²⁾	1000 ³⁾	2 x 100x5 ²⁾	3 x 100x5 ²⁾	4 x 100x5 ²⁾	

		AF145	AF185	AF210	AF260	AF300	AF400	AF460	AF580	AF750	AF1250	AF1350	AF1650	AF2050
Utilization category DC-3														
Contacts in series	L/R 2.5 ms													
1 contact	110 V						600	700	800	1050				
2 contacts	110 V	250	275	350	400	450	600	700	800	1050				
3 contacts	220 V	250	275	350	400	450	600	700	800	1050				
3 contacts	600 V						600	700	800	1050				
Conductor cross-sectional area	mm ²	120	150	185	240	300 ¹⁾	2x185	2x240	2 x 50x8 ²⁾	1000 ³⁾	2 x 100x5 ²⁾	3 x 100x5 ²⁾	4 x 100x5 ²⁾	

		AF145	AF185	AF210	AF260	AF300	AF400	AF460	AF580	AF750	AF1250	AF1350	AF1650	AF2050
Utilization category DC-5														
Contacts in series	L/R 15 ms													
1 contact	110 V						600	700	800	1050				
2 contacts	110 V	250	275	350	400	450	600	700	800	1050				
3 contacts	220 V	250	275	350	400	450	600	700	800	1050				
3 contacts	600 V						600	700	800	1050				
Conductor cross-sectional area	mm ²	120	150	185	240	300 ¹⁾	2x185	2x240	2 x 50x8 ²⁾	1000 ³⁾	2 x 100x5 ²⁾	3 x 100x5 ²⁾	4 x 100x5 ²⁾	

¹⁾ For currents above 450 A use 300 mm² and terminal extension / enlargement pieces (LW300: see www.abb.com/lowvoltage or local ABB catalog)

²⁾ Dimension of the bars (mm)

³⁾ Max connection bar width 50 mm

cULus

		AF145	AF185	AF210	AF260	AF300	AF400	AF460	AF580	AF750	AF1250	AF1350	AF1650	AF2050
Intended device application general purpose														
Contacts in series														
3 contacts	240 V		250				550	650	750	900	1210		1350	1900
3 contacts	600 V						550	650	750	900	1210		1350	1900

General

- When selecting a contactor for DC switching it is essential to determine the current, the voltage and the L/R time constant of the controlled load.
- The loads are defined by the time constant L/R: non inductive loads such as resistance furnaces (L/R ≈ 1 ms), inductive loads such as shunt motors (L/R ≈ 2 ms) or series motors (L/R ≈ 7.5 ms).
- In addition to the block contactors shown in this document:
 - 1) ABB also offers bar mounted contactors (R-series). Bar contactors can typically be used for higher amps and voltages or other configurations or number of main poles (contacts).

Technical data

DC contactors GAF and AF

Main technical data

IEC60947-4-1

Contactor type GAF		GAF185		GAF300		GAF460		GAF750	GAF1250	GAF1650	GAF2050
Rated operational voltage U_e max	V DC	1000									
IEC 60947-4-1, DC-1, $\theta \leq 40$ °C	A	275		500		700		1050	1250	1650	2050
Conductor cross-sectional area	mm ²	150		300 ¹⁾		2x240		2 x 50x8 ²⁾	1000 ³⁾	3 x 100x5 ²⁾	4 x 100x5 ²⁾

¹⁾ For currents above 450 A use 300 mm² and terminal extension / enlargement pieces (LW300: see www.abb.com/lowvoltage or local ABB catalog)

²⁾ Dimension of the bars (mm)

³⁾ Max connection bar width 50 mm

cULus

Contactor type GAF		GAF185		GAF300
Rated operational voltage U_e max	V DC	600		
Amp-ratings general purpose	A	250		400

General technical data

Contactor type	GAF185												GAF300		GAF460		GAF750		GAF1250		GAF1650		GAF2050	
	AF145	AF185	AF210	AF260	AF300	AF400	AF460	AF580	AF750	AF1250	AF1350	AF1650	AF2050											
Rated making capacity DC-1															1.5 x I_e acc. to IEC60947-4-1									
Rated breaking capacity DC-1															1.5 x I_e acc. to IEC60947-4-1									
Rated frequency limits	Hz														25 ... 400									
Short-circuit protection for contactors without thermal O/L relay - Motor protection excluded															On request or see www.abb.com/lowvoltage or local ABB catalog									
Rated short-time withstand current, I_{sw}															On request or see www.abb.com/lowvoltage or local ABB catalog									
Heat dissipation per pole I_e /DC-1	W	13	16	18	25	32	30	42	32	50	80	80	125											
Rated impulse withstand voltage, U_{imp}	kV	8																						
Ambient temperature close to contactor - during operation / storage	°C	see "Conditions for use", for control voltage limits and authorized mounting																						
Operating altitude	m	≤3000 without derating																						

Magnet system characteristics

Rated control circuit voltage U_c		48 ... 250		48 ... 500		100 ... 250		
- at 50 Hz and 60 Hz	V	48 ... 250		48 ... 500		100 ... 250		
- d.c.	V	20 ... 250		24 ... 500		100 ... 250		
Coil operating limits acc. IEC60947-4-1							0.85 x U_c min. ... 1.1 x U_c max. (at $\theta \leq 70$ °C) Please also refer to "Mounting characteristics"	
Drop-out voltage in % of U_c min.	%	55						
Coil consumption								
Average pull-in value	50 Hz and 60 Hz	VA	430	470	890	850	850	1900
	d.c.	W	500	520	990	950	950	1700
Average holding value	50 Hz and 60 Hz	VA/W	12/3.5	10/2.5	12/4	12/4.5	12/4	48/17
	d.c.	W	2	2	4	4.5	4	16
Operating time coil supply between A1-A2	On request or see www.abb.com/lowvoltage or local ABB catalog							

Mounting characteristics

Mounting positions	- mounting on a vertical plane: any position with a tilt up to $\pm 30^\circ$ - mounting on a horizontal plane: any position with a tilt up to $\pm 30^\circ$, except up-side down		
Fixing			
- by screws (not supplied)	4 x M5	4 x M6	4 x M8

Connections

Recommended connection

All three contacts connected in series without the load in between. This connection is recommended in systems according to the configurations below.

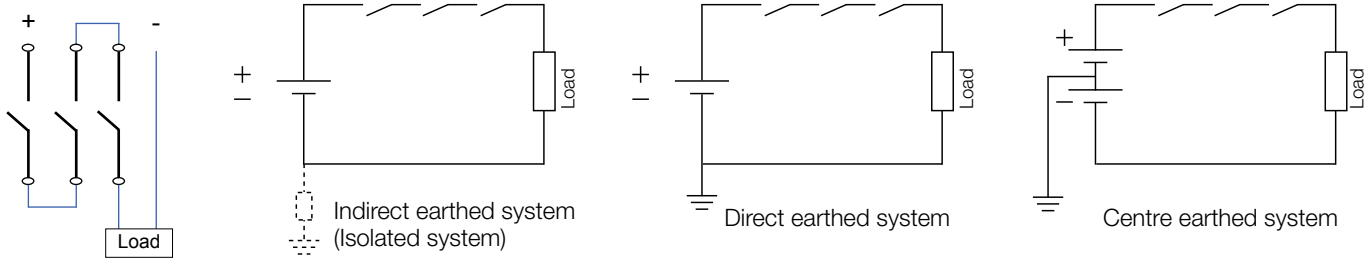

Alternative connection

The load is placed in between the three contacts in an indirect earthed system or in a fully isolated system. If not connected according to the configuration below, a fault to earth could result in one or two contacts breaking the full load which the contactor is not approved for.

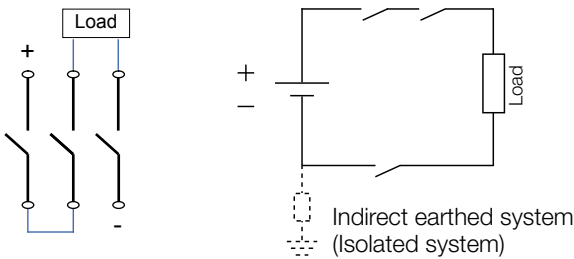

Points to consider

- The above relates to power circuit switching. The SCPD (Short Circuit Protection Device) must comply with applicable protection rules.
- The direction of the current must be as shown on the contactor front label.
- Connection bars for connecting three contacts in series are not delivered with the contactor as standard, but are available as accessories.

For further information regarding connections see Technical paper.

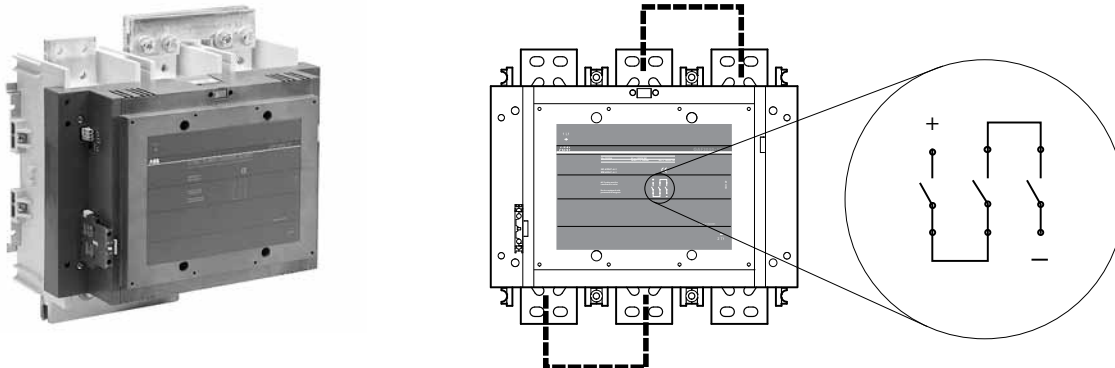

Approximate dimensions (mm)

GA75

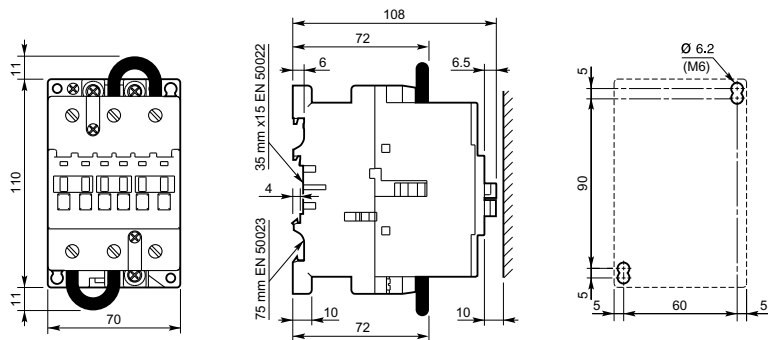

GAE75

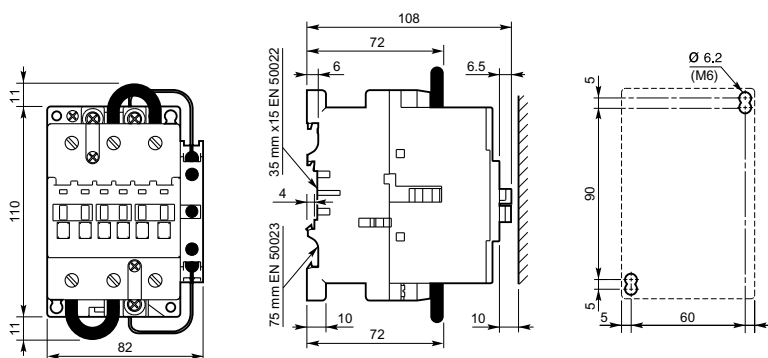

Approximate dimensions

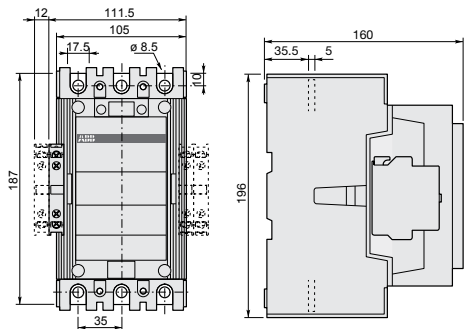

GAF185
AF145, AF185

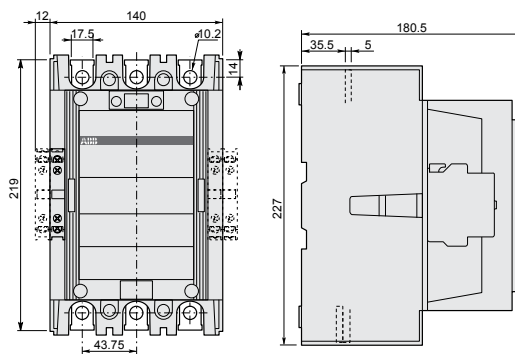

GAF300
AF210 ... AF300

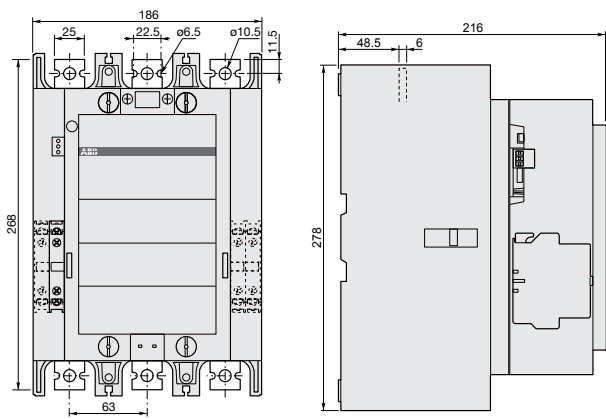

GAF460
AF400, AF460

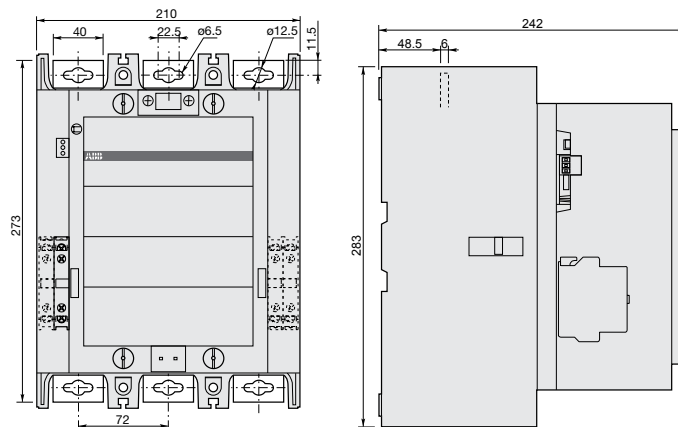

GAF750
AF580, AF750

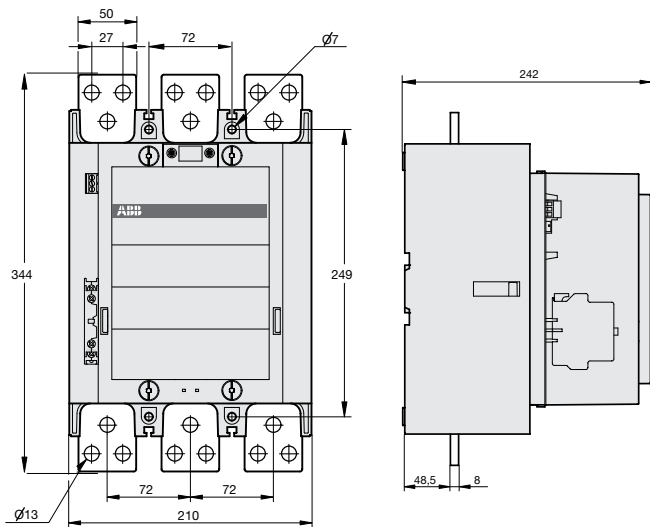

GAF1250,
AF1250

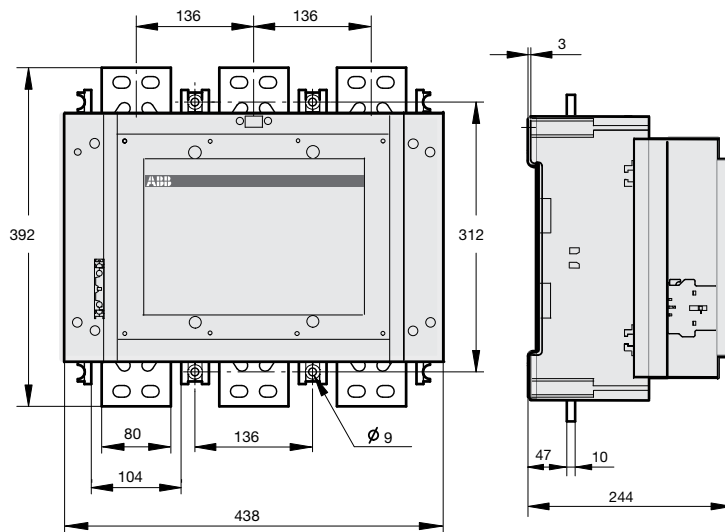

GAF1650, GAF2050
AF1350, AF1650, AF2050

Dimensions in mm
Inch converter: 1 mm = 0.0394 in

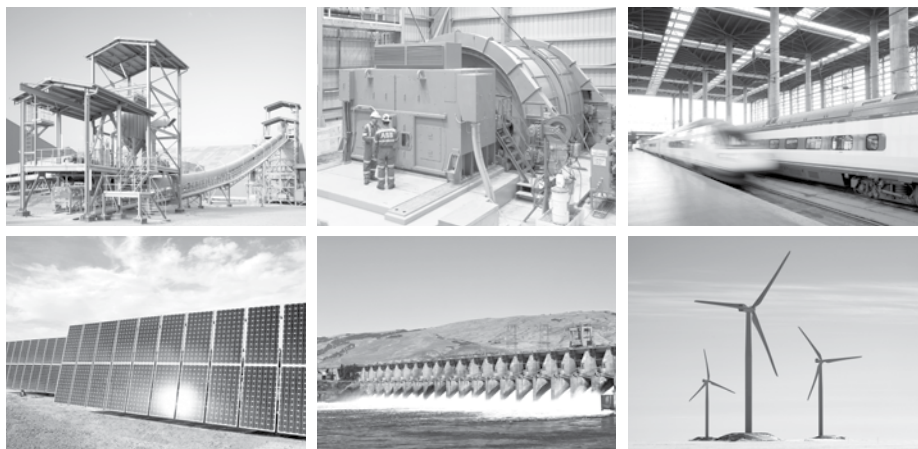

R contactors with variable number of poles and their variants (contactors with N.C. + N.O. poles, couplers...) are used for controlling power circuits up to 1000 V AC or 1500 V DC. They are designed with common standard components. With the combination of these elements and the adaptation possibilities, special versions can be provided. Designed for long-lasting operation and demanding applications, the ABB R contactors are used for many applications all over the world.

Flexibility of design

- Variable number of poles
- Adjustable number of auxiliary contacts
- Optional combination of N.O. & N.C. poles
- Mechanical or magnetic latching available.

Easy maintenance

- Direct access to all the components of the contactor
- Complete and didactic instruction manual
- Spare parts available
- Dedicated service for bar contactors.

Exceptional durability

- Mechanical durability up to 10 millions operating cycles
- Mechanical switching frequency up to 1200 cycles per hour
- Electrical durability up to 350 000 operating cycles.

Ideal for heavy duty applications

- High making and breaking capacity
- Fully compatible with the requirements of utilization categories AC-3, DC-3 and DC-5 (control of AC / DC motors for mining, iron and steel industries...).

Custom-made solutions

- More than 60 years' experience in dealing with customers projects
- Development of solutions from specifications
- Pre-sales support to identify and define customer requirements
- Specialists available to help you, select your product or optimize your configuration.

Bar Contactors

Bar contactors

For heavy duty applications

Bar contactors meet the particular requirements of each AC / DC control application up to 5000 A, where the demands are increasing:

- Power distribution
- Photovoltaic, hydroelectric power stations
- Batteries
- Mining
- Railway networks and rolling stock
- Induction furnaces
- Pump stations
- Travelling cranes.



Control your AC applications up to 5000 A

AC-1 Rated operational current up to 5000 A

AC-3 Rated power up to 1500 kW (1520 A - 440 V)

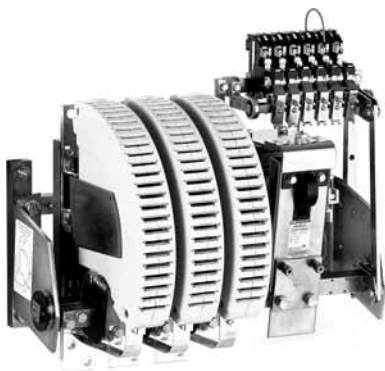

Control your DC applications up to 5000 A

DC-1 Rated operational current up to 5000 A

DC-3 / DC-5 Rated operational current up to 2000 A
1500 V with poles in series

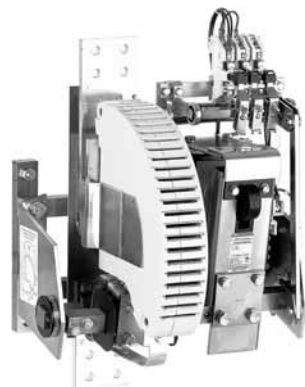

Special applications

AC / DC coupling: LOR.. contactors

Slip ring motor control: FOR.. contactors

AC / DC switching (N.C. / N.O. main poles): NOR & JOR..
contactors

Latching contactors for energy saving and safety require-
ments: AMA or AME contactors

Field discharge: AM(F)-CC-JORE.. contactors

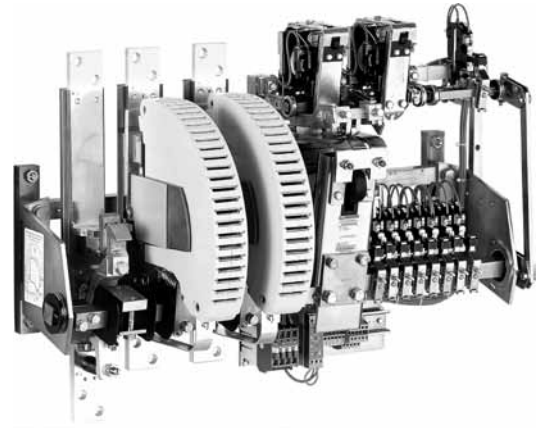

Bar contactors for the AC circuits switching

Voltage U_e up to 1000 V AC
Current I_e up to 4500 A

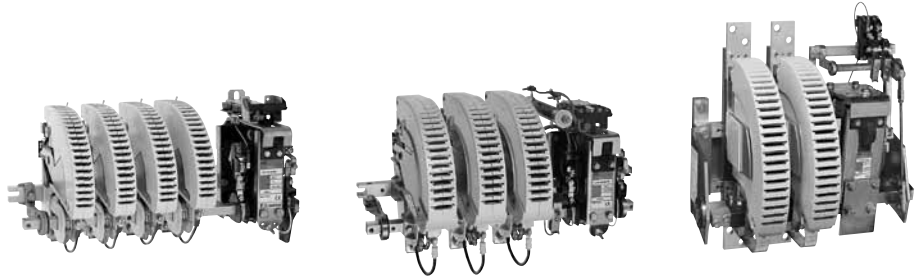

Contactor type	AC control circuit	~	IORR63..-MT	IORR125..-MT	IORR200..-MT	IORR400..-MT	IORR500..-MT	IORR800..-MT
	DC control circuit	≡	IORE63..-MT	IORE125..-MT	IORE200..-MT	IORE400..-MT	IORE500..-MT	IORE800..-MT
Categories		U_e						
AC-1	at 40 °C		I_e : 85 A	170 A	260 A	400 A	550 A	800 A
AC-3	690 V AC		I_e : 85 A	160 A	260 A	400 A	550 A	800 A
	1000 V AC max.		I_e : 56 A	105 A	180 A	280 A	380 A	580 A
AC-3	690 V AC	Power	80 kW	150 kW	240 kW	400 kW	540 kW	780 kW

Voltage U_e up to 500 V AC
Current I_e up to 5000 A

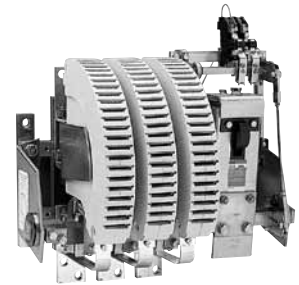

Contactor type	AC control circuit	~	-					IORR800
	DC control circuit	≡	-					IORE800
Categories		U_e						
AC-1	at 40 °C		I_e :	From 85 A to 550 A, select above IOR..-MT				900 A
AC-3	380-415-440 V AC		I_e :	-				800 A
	500 V AC max.		I_e :	-				800 A
AC-3	400 V AC	Power	-					450 kW

Recap:

All contactors fulfill the IEC 60947-4-1 / EN 60947-4-1 standards.

Utilization category AC-1: max. breaking current = 1.5 x I_e ,
max. making current = 1.5 x I_e .

Utilization category AC-3: max. breaking current = 8 x I_e ,
max. making current = 10 x I_e .

Contactors with NC poles, magnetic or mechanical latching devices on request.

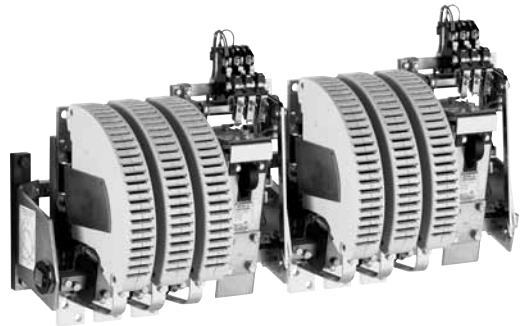
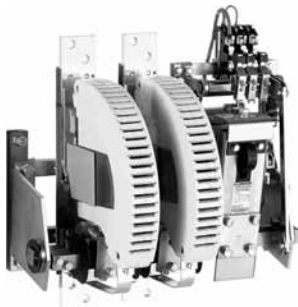

IORR1400..-MT	IORR1700..-MT	IORR2100..-MT	IORR2500..-MT	IORR3200..-MT	IORR3800..-MT	IORR4500..-MT	IORR5100..-MT
IORE1400..-MT	IORE1700..-MT	IORE2100..-MT	IORE2500..-MT	IORE3200..-MT	IORE3800..-MT	IORE4500..-MT	IORE5100..-MT
1250 A	1650 A	1850 A	2200 A	3000 A	3500 A	4000 A	4500 A
970 A	1170 A	1270 A	-	-	-	-	-
610 A	680 A	810 A	-	-	-	-	-
1000 kW	1200 kW	1300 kW	-	-	-	-	-

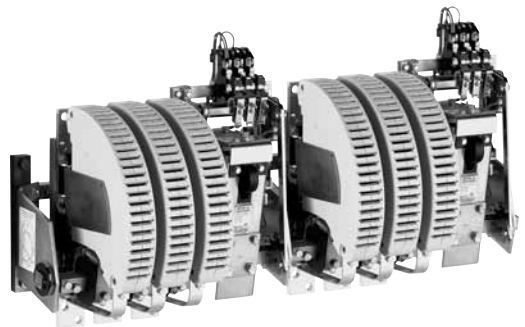
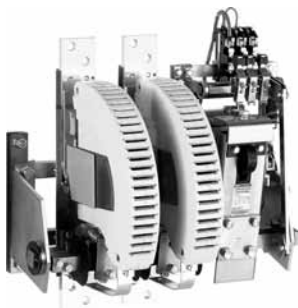

IORR1000	IORR1400	IORR1700	IORR2100	IORR2500	IORR3200	IORR3800	IORR4500	IORR5100
IORE1000	IORE1400	IORE1700	IORE2100	IORE2500	IORE3200	IORE3800	IORE4500	IORE5100
1000 A	1350 A	1650 A	2000 A	2400 A	3200 A	3800 A	4500 A	5000 A
800 A	1060 A	1260 A	1520 A	-	-	-	-	-
800 A	1080 A	1220 A	1340 A	-	-	-	-	-
450 kW	630 kW	750 kW	900 kW	-	-	-	-	-

Bar contactors for the DC circuits switching

Voltage U_e up to 1500 V DC
Current I_e up to 5000 A

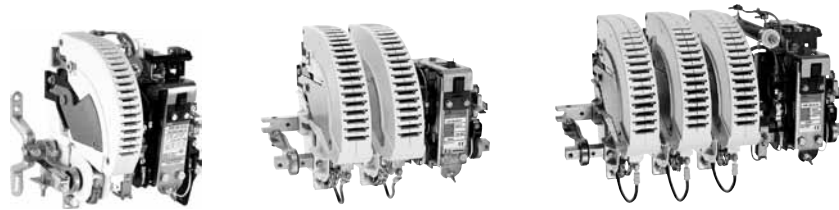

Contactor type	AC control circuit	~	IORR63..-CC	IORR125..-CC	IORR200..-CC	IORR400..-CC	IORR500..-CC
	DC control circuit	≡	IORE63..-CC	IORE125..-CC	IORE200..-CC	IORE400..-CC	IORE500..-CC
Number of poles in series*	Categories	U _e max.					
	1 pole	DC-1	500 V DC	I _e 85 A	170 A	275 A	400 A
DC-3 / DC-5		500 V DC	I _e 68 A	140 A	205 A	350 A	500 A
2 poles	DC-1	1000 V DC	I _e 85 A	170 A	275 A	400 A	550 A
	DC-3 / DC-5	1000 V DC	I _e 68 A	140 A	205 A	350 A	500 A
3 poles	DC-1	1500 V DC	I _e 85 A**	170 A**	275 A**	400 A**	550 A**
	DC-3 / DC-5	1500 V DC	I _e 68 A**	140 A**	205 A**	350 A**	500 A**

*Number of poles to be fitted in series according to the operational voltage and the utilization categories.

**Version with increased insulation for 1000 V DC < U_e ≤ 1500 V DC, please consult us.

Contactors
UL / CSA approved 

Voltage U_e up to 600 V DC
Current I_e up to 2000 A

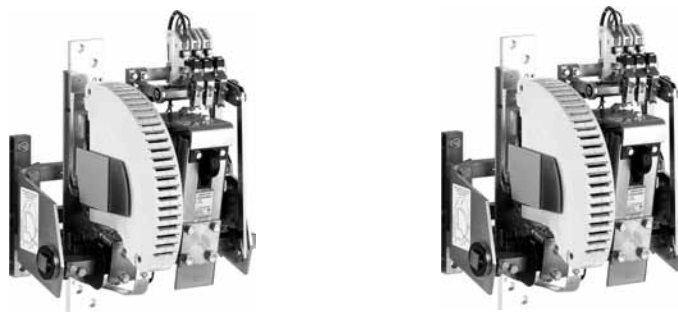

Contactor type	AC control circuit	~	IORR800-10-CC	IORR1000-10-CC	IORR1400-10-CC	IORR1700-10-CC	IORR2100-10-CC
	DC control circuit	≡	IORE800-10-CC	IORE1000-10-CC	IORE1400-10-CC	IORE1700-10-CC	IORE2100-10-CC
		U max.					
1 pole	General use	600 V DC	I _e 800 A	1000 A	1300 A	1700 A	2000 A

Recap:

All contactors fulfill the IEC 60947-4-1 / EN 60947-4-1 standards.

Utilization category DC-1: max. breaking current = 1.5 x I_e,
max. making current = 1.5 x I_e.

Utilization categories DC-3 / DC-5: max. breaking current = 4 x I_e,
max. making current = 4 x I_e.

Contactors with NC poles, magnetic or mechanical latching devices on request.

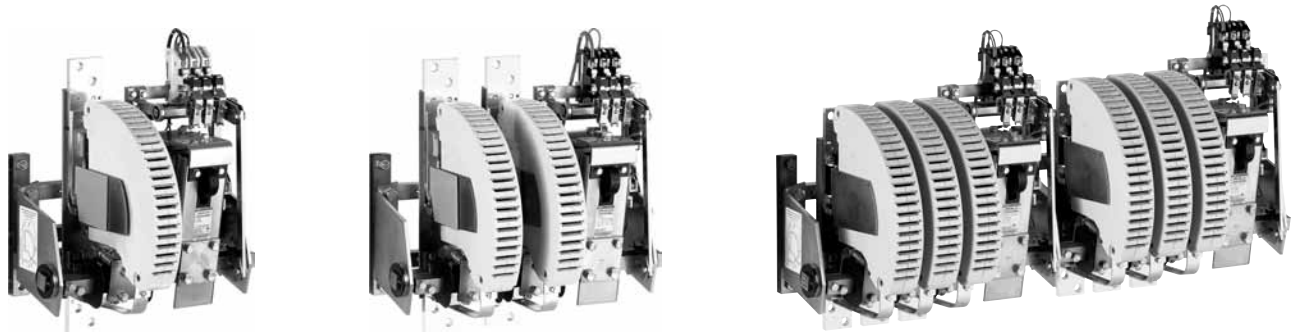

IORR800.-CC IORR1000.-CC IORR1400.-CC IORR1700.-CC IORR2100.-CC IORR2500.-CC IORR3200.-CC IORR3800.-CC IORR4500.-CC IORR5100.-CC
 IORE800.-CC IORE1000.-CC IORE1400.-CC IORE1700.-CC IORE2100.-CC IORE2500.-CC IORE3200.-CC IORE3800.-CC IORE4500.-CC IORE5100.-CC

Ue max.	IORR800.-CC	IORR1000.-CC	IORR1400.-CC	IORR1700.-CC	IORR2100.-CC	IORR2500.-CC	IORR3200.-CC	IORR3800.-CC	IORR4500.-CC	IORR5100.-CC
750 V DC	800 A	1000 A	1250 A	1600 A	2000 A	2300 A	3200 A	3800 A	4500 A	5000 A
600 V DC	720 A	1000 A	1250 A	1600 A	2000 A	On request	On request	On request	On request	On request
1500 V DC	800 A	1000 A	1250 A	1600 A	2000 A	2300 A	3200 A	3800 A	4500 A	5000 A
1000 V DC	720 A	1000 A	1250 A	1600 A	2000 A	On request	On request	On request	On request	On request
1500 V DC	800 A	1000 A	1250 A	1600 A	2000 A	2300 A	3200 A	3800 A	4500 A	5000 A
1500 V DC	720 A	1000 A	1250 A	1600 A	2000 A	On request	On request	On request	On request	On request

Product overview

Upper terminal plate
for power circuit (network)

2 N.O. main poles with arc chutes

Main frame
for contactor fixing

Lower terminal plate
for power circuit (utilization)

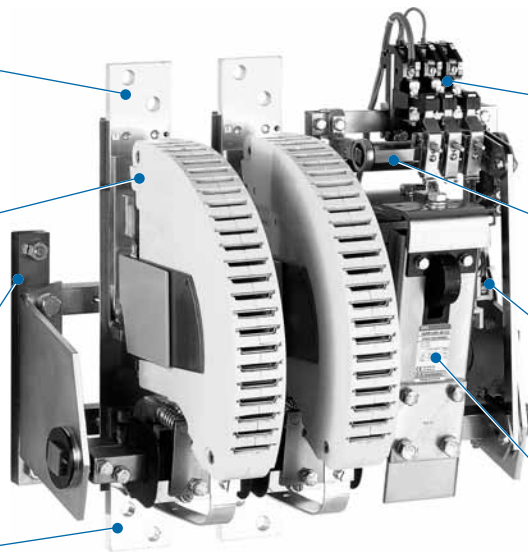

CA15.. auxiliary contacts
1 N.O. + 1 N.C. fitted as
standard (extra auxiliary
contacts on request)

Auxiliary frame
for auxiliary contacts

Connecting terminals
for coil supply

Electro-magnet (RR type),
laminated magnetic circuit,
AC coil, direct supply

Questionnaire

Specification for R contactors

Customer
 Contact person Date
 Tel. e-mail

ABB
 Contact person
 Tel.

Quantity Requested delivery date
 Project / Application

Power circuit

AC switching

Application type

- AC-1 (resistive load)
- AC-3 (direct starting, switching off running motors)
- No load breaking
- Other

Number of poles: N.O. N.C.

Rated operational current I_e A
 Max. making current A
 Max. breaking current A
 Rated operational voltage U_e V Hz

or

DC switching

Application type

- DC-1 (resistive load)
- DC-3 (shunt motors)
- DC-5 (series motors)
- No load breaking
- Other L/R ms

Number of poles: N.O. N.C.

Rated operational current I_e A
 Making current A
 Breaking current min. A max. A
 Rated operational voltage U_e V DC

Auxiliary contacts

Number of N.O. auxiliary contacts
 Number of N.C. auxiliary contacts

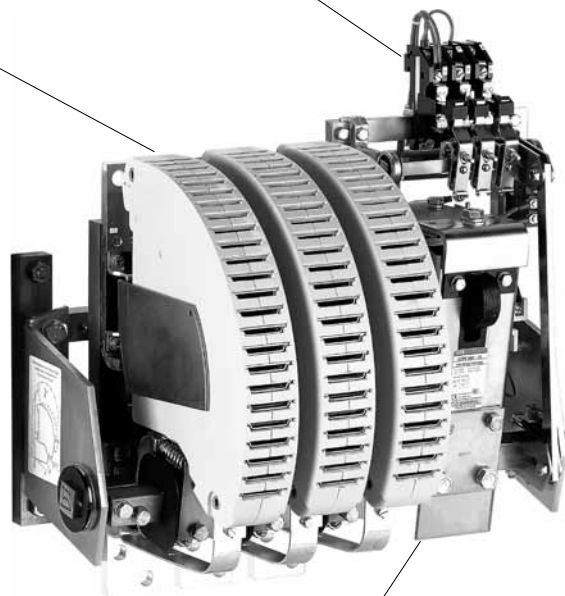

Control circuit (coil)

AC Voltage V Hz
 DC Voltage V DC

Options

- Magnetical latching
- Mechanical latching

Operating conditions

Switching frequency cycles/h
 Mech. durability required (millions of operating cycles)
 Remarks

Accessories

Please add any other useful documents for further information e.g. technical specification, drawing, wiring diagram, etc.

Replacement of an existing contactor

Brand
 Type
 Fixing dimension F = mm
 Overall dimensions W = mm
 H = mm
 D = mm

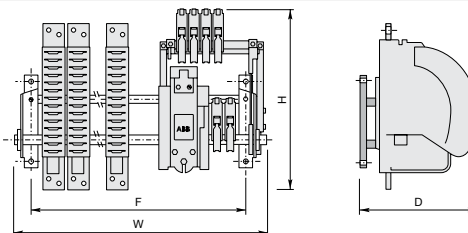

Please photocopy and forward. Questionnaire also available on the ABB Website:

www.abb.com/lowvoltage Section: Our offering Select: Control Products > Contactors > Bar mounted contactors

Notes