



TISP4072F3LM THRU TISP4082F3LM,
TISP4125F3LM THRU TISP4180F3LM,
TISP4240F3LM THRU TISP4380F3LM

BIDIRECTIONAL THYRISTOR OVERVOLTAGE PROTECTORS

TISP4xxxF3LM Overvoltage Protector Series

**Ion-Implanted Breakdown Region
Precise and Stable Voltage
Low Voltage Overshoot under Surge**

Device	V _{DRM} V	V _(BO) V
'4072	58	72
'4082	66	82
'4125	100	125
'4150	120	150
'4180	145	180
'4240	180	240
'4260	200	260
'4290	220	290
'4320	240	320
'4380	270	380

Rated for International Surge Wave Shapes

Waveshape	Standard	I _{TSP} A
10/160 μs	FCC Part 68	60
0.5/700 μs	I3124	38
10/700 μs	ITU-T K.20/21	50
10/560 μs	FCC Part 68	45
10/1000 μs	REA PE-60	35

..... **UL Recognized Component**

Description

These devices are designed to limit overvoltages on the telephone line. Overvoltages are normally caused by a.c. power system or lightning flash disturbances which are induced or conducted on to the telephone line. A single device provides 2-point protection and is typically used for the protection of 2-wire telecommunication equipment (e.g. between the Ring to Tip wires for telephones and modems). Combinations of devices can be used for multi-point protection (e.g. 3-point protection between Ring, Tip and Ground).

The protector consists of a symmetrical voltage-triggered bidirectional thyristor. Overvoltages are initially clipped by breakdown clamping until the voltage rises to the breakover level, which causes the device to crowbar into a low-voltage on state. This low-voltage on state causes the current resulting from the overvoltage to be safely diverted through the device. The high crowbar holding current prevents d.c. latchup as the diverted current subsides.

How To Order

Device	Package	Carrier	For Standard Termination Finish Order As	For Lead Free Termination Finish Order As
TISP4xxxF3LM	Straight Lead DO-92 (LM)	Bulk Pack	TISP4xxxF3LM	TISP4xxxF3LM-S
		Tape and Reeled	TISP4xxxF3LMR	TISP4xxxF3LMR-S
	Formed Lead DO-92 (LMF)	Tape and Reeled	TISP4xxxF3LMFR	TISP4xxxF3LMFRS

Insert xxx value corresponding to protection voltages of 072, 082, 125 etc.

*RoHS Directive 2002/95/EC Jan 27 2003 including Annex NOVEMBER 1997 - REVISED FEBRUARY 2005
Specifications are subject to change without notice.
Customers should verify actual device performance in their specific applications.

LM Package (Top View)

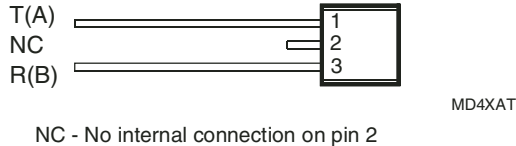

LMF Package (LM Package with Formed Leads) (Top View)

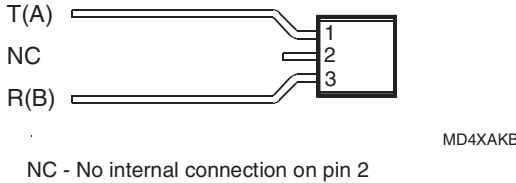

Device Symbol



Terminals T and R correspond to the alternative line designators of A and B

TISP4xxxF3LM Overvoltage Protector Series

BOURNS®

Description (continued)

This TISP4xxxF3LM range consists of ten voltage variants to meet various maximum system voltage levels (58 V to 270 V). They are guaranteed to voltage limit and withstand the listed international lightning surges in both polarities. These protection devices are supplied in a DO-92 (LM) cylindrical plastic package. The TISP4xxxF3LM is a straight lead DO-92 supplied in bulk pack and on tape and reeled. The TISP4xxxF3LMF is a formed lead DO-92 supplied only on tape and reeled.

Absolute Maximum Ratings, $T_A = 25\text{ }^\circ\text{C}$ (Unless Otherwise Noted)

Rating	Symbol	Value	Unit	
Repetitive peak off-state voltage ($0\text{ }^\circ\text{C} < T_J < 70\text{ }^\circ\text{C}$)	'4072	± 58	V	
	'4082	± 66		
	'4125	± 100		
	'4150	± 120		
	'4180	± 145		
	'4240	± 180		
	'4260	± 200		
	'4290	± 220		
	'4320	± 240		
	'4380	± 270		
Non-repetitive peak on-state pulse current (see Notes 1, 2 and 3)	I_{TSP}		A	
2/10 μs (FCC Part 68, 2/10 μs voltage wave shape) excluding '4072 - '4082				175
8/20 μs (ANSI C62.41, 1.2/50 μs voltage wave shape) excluding '4072 - '4082				120
10/160 μs (FCC Part 68, 10/160 μs voltage wave shape)				60
5/200 μs (VDE 0433, 2 kV, 10/700 μs voltage wave shape)				50
0.2/310 μs (I3124, 1.5 kV, 0.5/700 μs voltage wave shape)				38
5/310 μs (ITU-T K.20/21, 1.5 kV, 10/700 μs voltage wave shape)				38
5/310 μs (FTZ R12, 2 kV, 10/700 μs voltage wave shape)				50
10/560 μs (FCC Part 68, 10/560 μs voltage wave shape)				45
10/1000 μs (REA PE-60, 10/1000 μs voltage wave shape)				35
2/10 μs (FCC Part 68, 2/10 μs voltage wave shape) '4072 - '4082 only				80
8/20 μs (ANSI C62.41, 1.2/50 μs voltage wave shape) '4072 - '4082 only				70
Non-repetitive peak on-state current (see Notes 2 and 3)	I_{TSM}	4	A	
50/60 Hz, 1 s				
Initial rate of rise of on-state current, Linear current ramp, Maximum ramp value $< 38\text{ A}$	di_T/dt	250	A/ μs	
Junction temperature	T_J	-40 to +150	$^\circ\text{C}$	
Storage temperature range	T_{stg}	-55 to +150	$^\circ\text{C}$	

- NOTES: 1. Initially the TISP must be in thermal equilibrium with $0\text{ }^\circ\text{C} < T_J < 70\text{ }^\circ\text{C}$.
 2. The surge may be repeated after the TISP returns to its initial conditions.
 3. Above $70\text{ }^\circ\text{C}$, derate linearly to zero at $150\text{ }^\circ\text{C}$ lead temperature.

TISP4xxxF3LM Overvoltage Protector Series

BOURNS®

Electrical Characteristics for R and T Terminals, $T_J = 25\text{ }^\circ\text{C}$ (Unless Otherwise Noted)

Parameter	Test Conditions	Min	Typ	Max	Unit
I_{DRM} Repetitive peak off-state current	$V_D = \pm V_{\text{DRM}}$, $0\text{ }^\circ\text{C} < T_J < 70\text{ }^\circ\text{C}$			± 10	μA
$V_{(\text{BO})}$ Breakover voltage	$dv/dt = \pm 250\text{ V/ms}$, $R_{\text{SOURCE}} = 300\ \Omega$			'4072 ± 72 '4082 ± 82 '4125 ± 125 '4150 ± 150 '4180 ± 180 '4240 ± 240 '4260 ± 260 '4290 ± 290 '4320 ± 320 '4380 ± 380	V
$V_{(\text{BO})}$ Impulse breakover voltage	$dv/dt = \pm 1000\text{ V}/\mu\text{s}$, $R_{\text{SOURCE}} = 50\ \Omega$ $di/dt < 20\text{ A}/\mu\text{s}$			'4072 ± 86 '4082 ± 96 '4125 ± 143 '4150 ± 168 '4180 ± 198 '4240 ± 267 '4260 ± 287 '4290 ± 317 '4320 ± 347 '4380 ± 407	V
$I_{(\text{BO})}$ Breakover current	$dv/dt = \pm 250\text{ V/ms}$, $R_{\text{SOURCE}} = 300\ \Omega$	± 0.15		± 0.6	A
V_T On-state voltage	$I_T = \pm 5\text{ A}$, $t_W = 100\ \mu\text{s}$			± 3	V
I_H Holding current	$I_T = \pm 5\text{ A}$, $di/dt = -/+ 30\text{ mA/ms}$	± 0.15			A
dv/dt Critical rate of rise of off-state voltage	Linear voltage ramp, Maximum ramp value $< 0.85V_{\text{DRM}}$	± 5			$\text{kV}/\mu\text{s}$
I_D Off-state current	$V_D = \pm 50\text{ V}$			± 10	μA
C_{off} Off-state capacitance	$f = 100\text{ kHz}$, $V_d = 1\text{ V r.m.s.}$, $V_D = 0$, $f = 100\text{ kHz}$, $V_d = 1\text{ V r.m.s.}$, $V_D = -50\text{ V}$			'4072 - '4082 63 '4125 - '4180 43 '4240 - '4380 44 '4072 - '4082 25 '4125 - '4180 15 '4240 - '4380 11	pF

Thermal Characteristics

Parameter	Test Conditions	Min	Typ	Max	Unit
$R_{\theta\text{JA}}$ Junction to free air thermal resistance	EIA/JESD51-3 PCB mounted in an EIA/JESD51-2 enclosure			120	$^\circ\text{C}/\text{W}$

NOVEMBER 1997 - REVISED FEBRUARY 2005

Specifications are subject to change without notice.

Customers should verify actual device performance in their specific applications.

Parameter Measurement Information

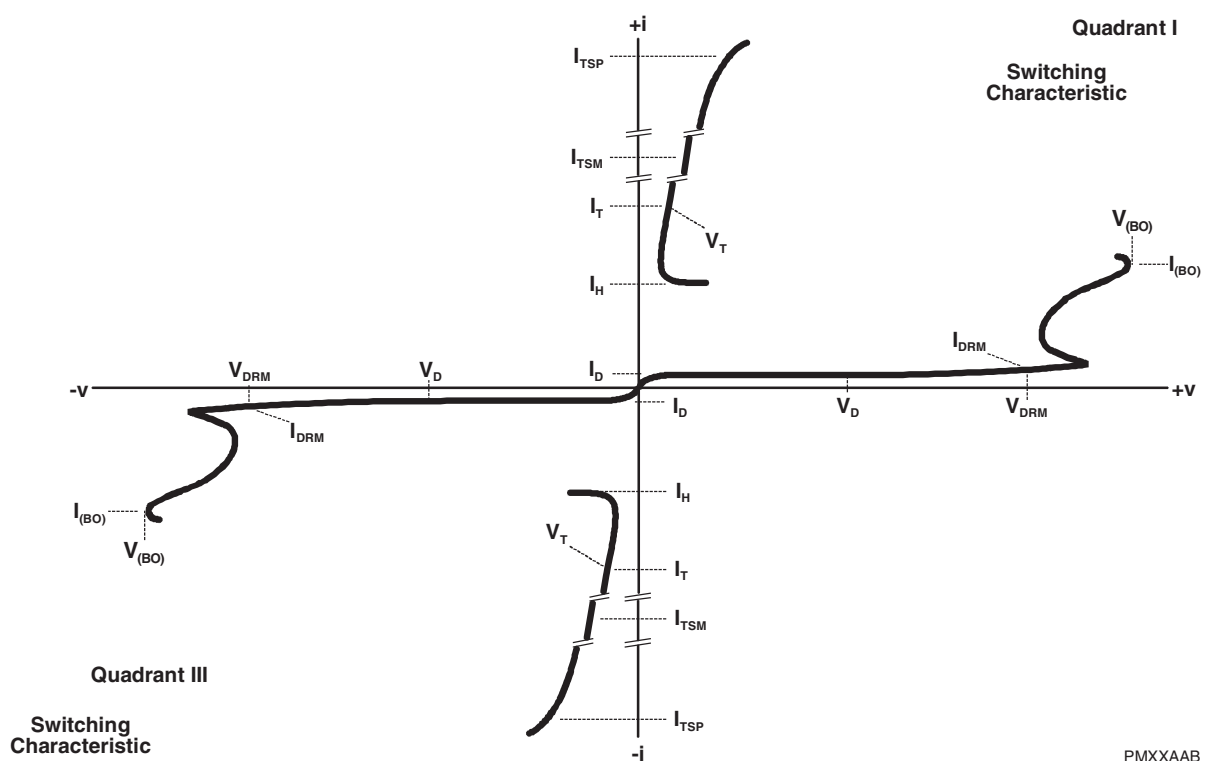

PMXXAAB

Figure 1. Voltage-Current Characteristic for R and T Terminals
All Measurements are Referenced to the T Terminal

Typical Characteristics

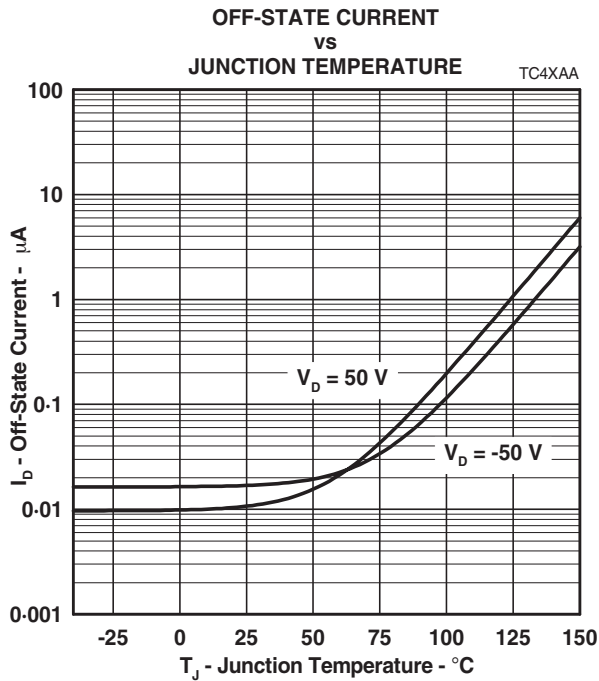

Figure 2.

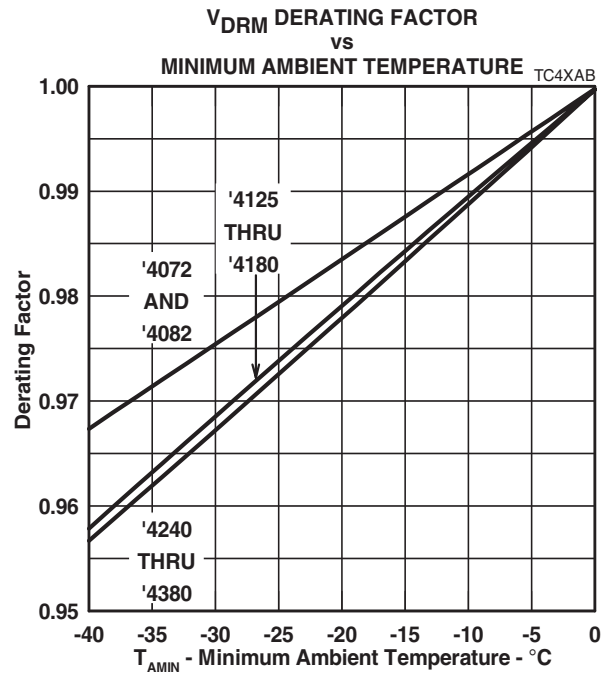

Figure 3.

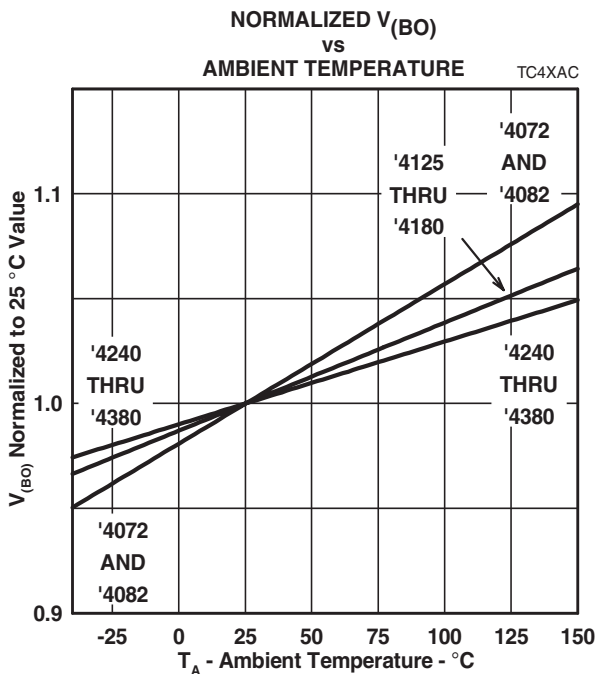

Figure 4.

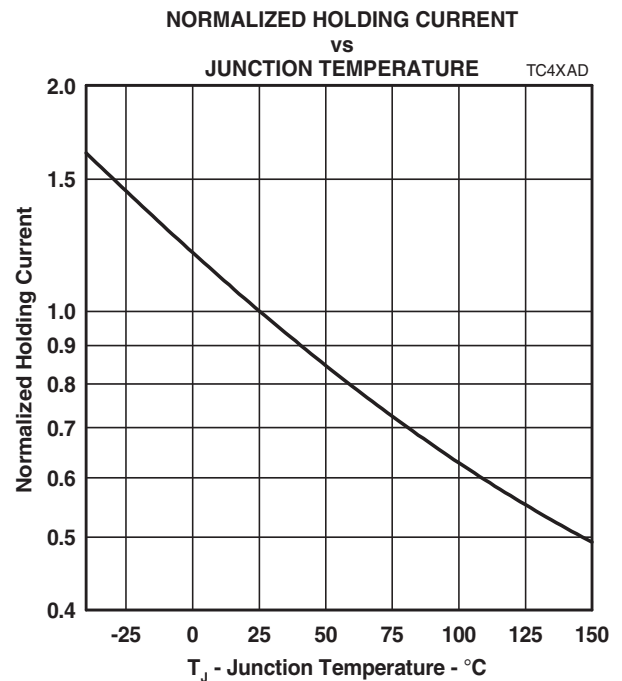
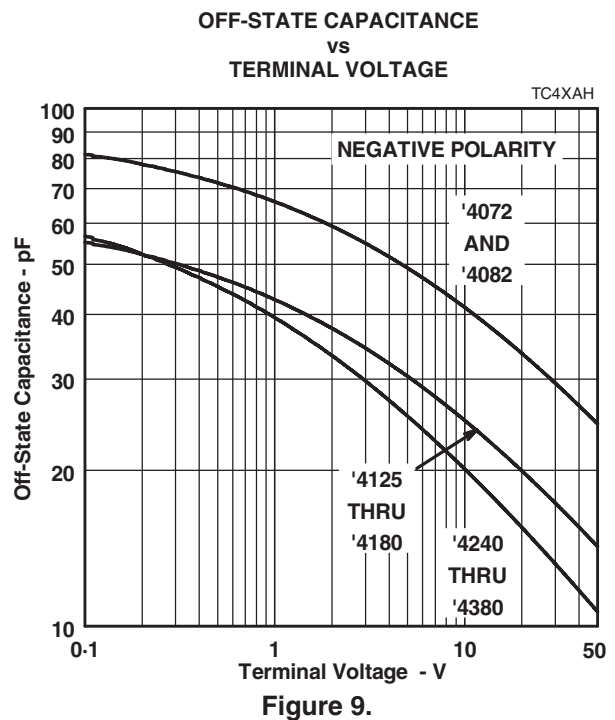
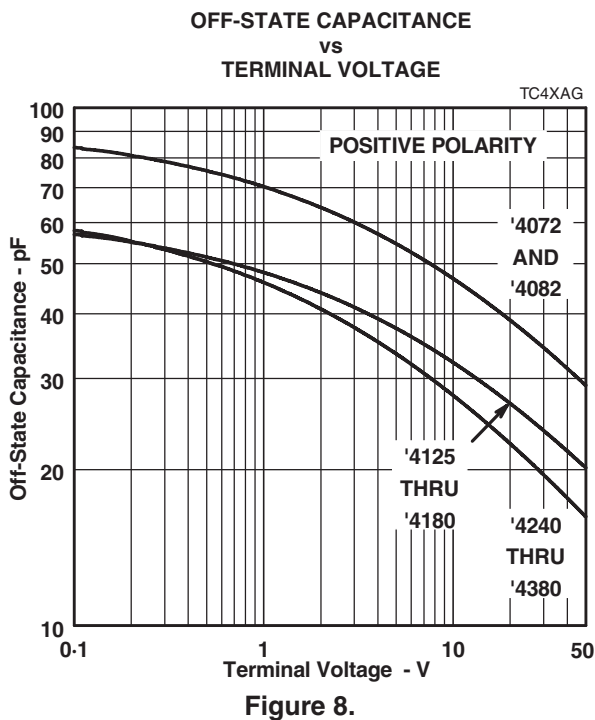
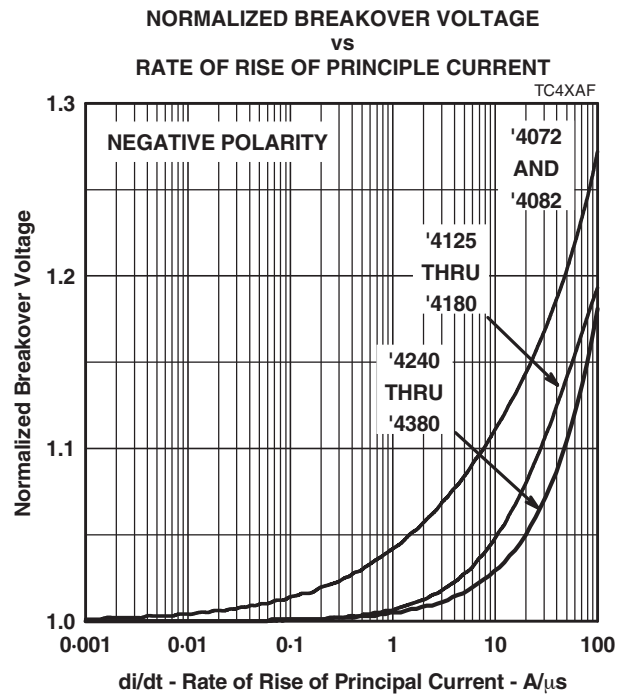
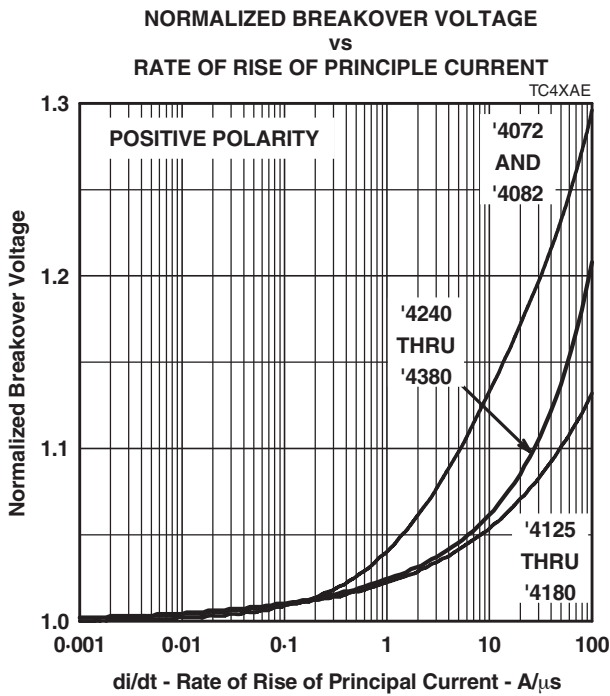

Figure 5.

Typical Characteristics



Typical Characteristics

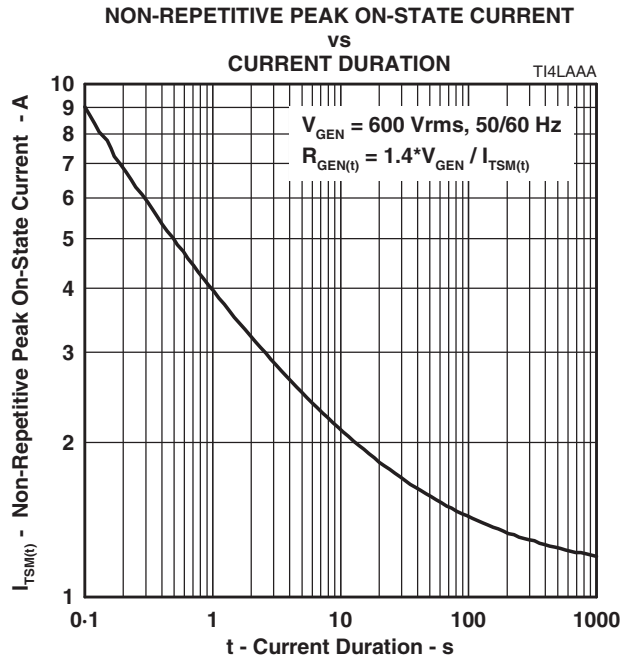

Figure 10.

TISP4xxxF3LM Overvoltage Protector Series

BOURNS®

MECHANICAL DATA

Device Symbolization Code

Devices will be coded as below.

Device	Symbolization Code
TISP4072F3	4072F3
TISP4082F3	4082F3
TISP4125F3	4125F3
TISP4150F3	4150F3
TISP4180F3	4180F3
TISP4240F3	4240F3
TISP4260F3	4260F3
TISP4290F3	4290F3
TISP4320F3	4320F3
TISP4380F3	4380F3

Carrier Information

Devices are shipped in one of the carriers below. A reel contains 2,000 devices.

Package Type	Carrier	For Standard Termination Finish Order As	For Lead Free Termination Finish Order As
Straight Lead DO-92	Bulk Pack	TISP4xxxF3LM	TISP4xxxF3LM-S
Straight Lead DO-92	Tape and Reeled	TISP4xxxF3LMR	TISP4xxxF3LMR-S
Formed Lead DO-92	Tape and Reeled	TISP4xxxF3LMFR	TISP4xxxF3LMFRS

MECHANICAL DATA

LM002 (DO-92) 2-Pin Cylindrical Plastic Package

This single-in-line package consists of a circuit mounted on a lead frame and encapsulated within a plastic compound. The compound will withstand soldering temperature with no deformation, and circuit performance characteristics will remain stable when operated in high humidity conditions. Leads require no additional cleaning or processing when used in soldered assembly.

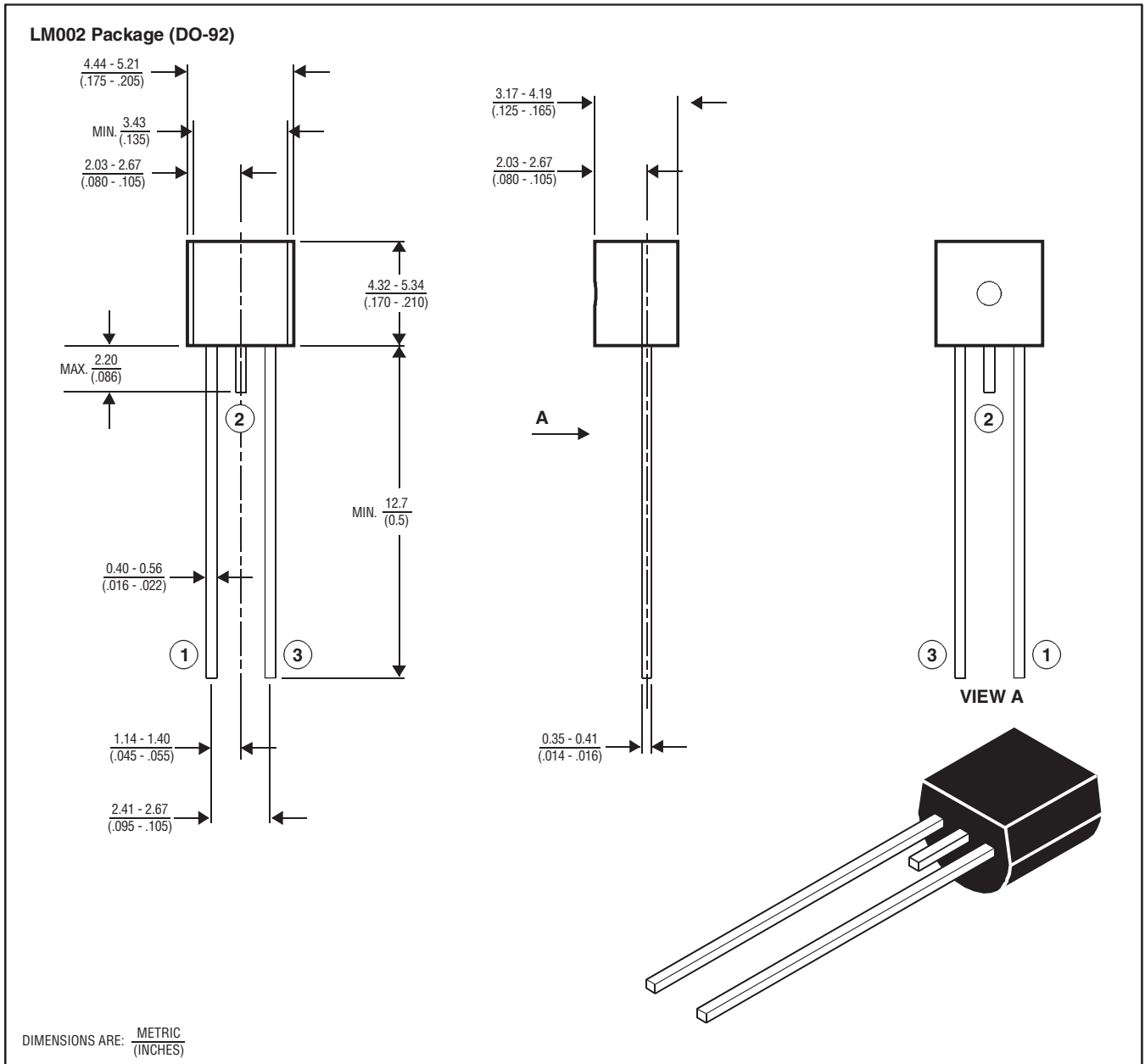

MD4XARA

MECHANICAL DATA

LM002 (DO-92) - Formed Leads Version - 2-Pin Cylindrical Plastic Package

This single-in-line package consists of a circuit mounted on a lead frame and encapsulated within a plastic compound. The compound will withstand soldering temperature with no deformation, and circuit performance characteristics will remain stable when operated in high humidity conditions. Leads require no additional cleaning or processing when used in soldered assembly.

LMF002 (DO-92) - Formed Leads Version of LM002

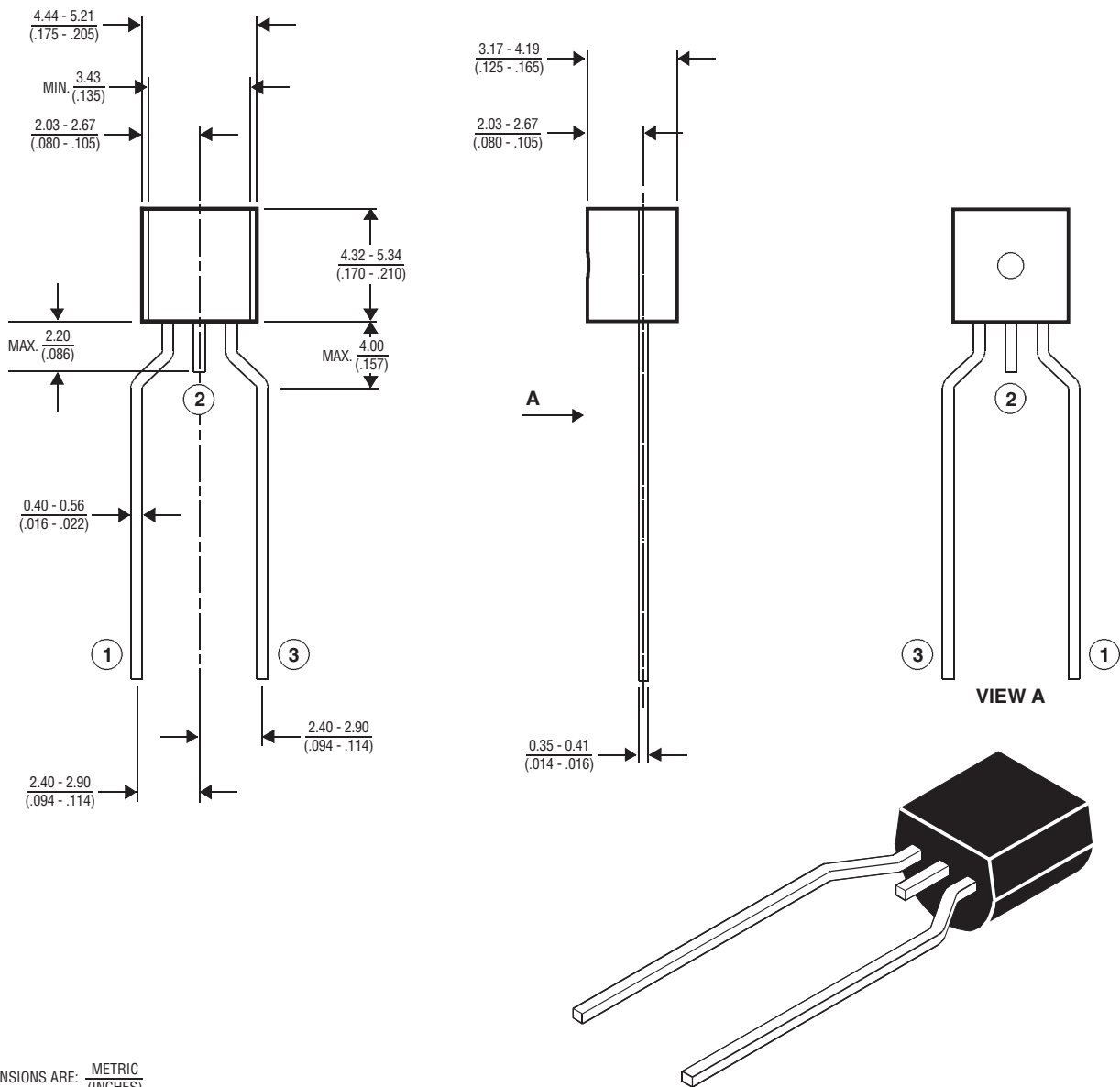

DIMENSIONS ARE: METRIC (INCHES)

MD4XASA

MECHANICAL DATA

Tape Dimensions

LMF002 Package (Formed Lead DO-92) Tape

LMF002 Tape Dimensions Conform to the Requirements of EIA-468-B

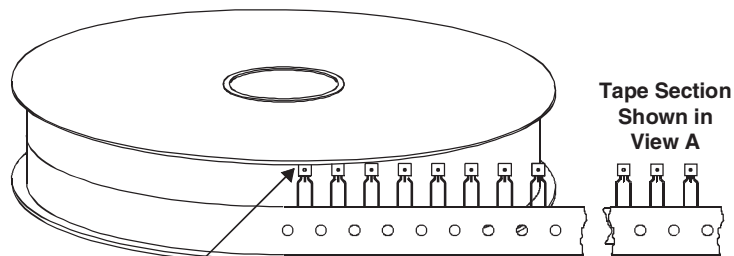
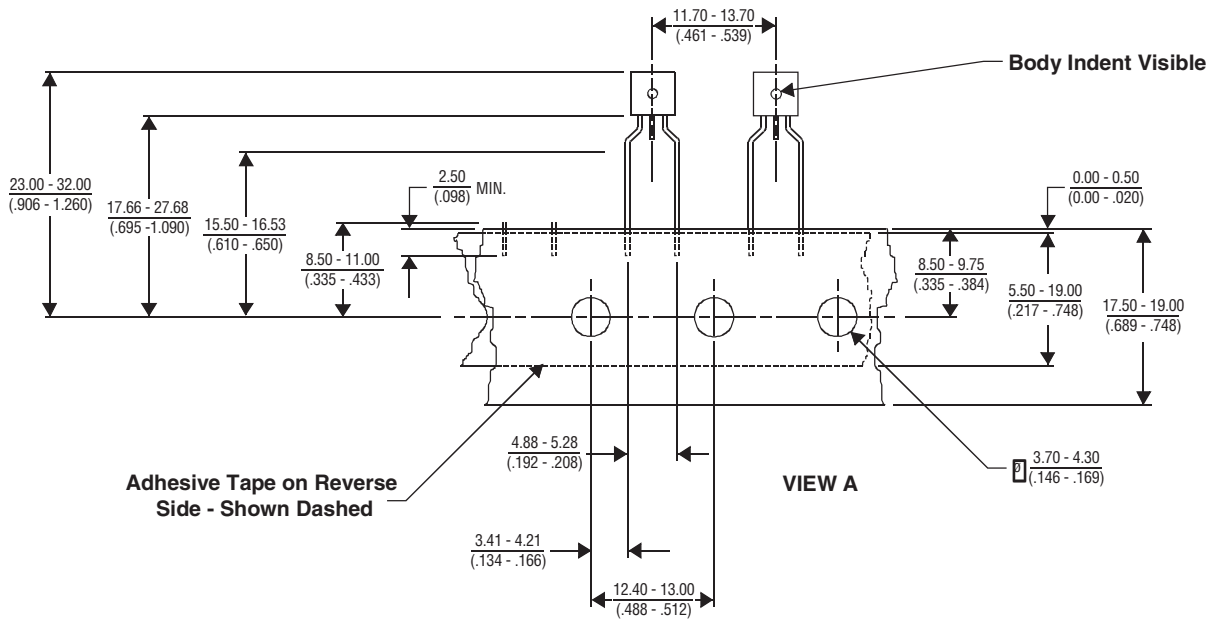

DIMENSIONS ARE: METRIC
(INCHES)

MD4XAQC

"TISP" is a trademark of Bourns, Ltd., a Bourns Company, and is Registered in U.S. Patent and Trademark Office.
"Bourns" is a registered trademark of Bourns, Inc. in the U.S. and other countries.

NOVEMBER 1997 - REVISED FEBRUARY 2005

Specifications are subject to change without notice.

Customers should verify actual device performance in their specific applications.