

NBC-M12MSX/ 2,0-94F/R4QC - Network cable



1407480

<https://www.phoenixcontact.com/de/produkte/1407480>

Please be informed that the data shown in this PDF document is generated from our Online Catalog. Please find the complete data in the user documentation. Our General Terms of Use for Downloads are valid.



Network cable, Ethernet CAT6_A (10 Gbps), CC-Link IE CAT6_A (10 Gbps), 8-position halogen-free, shielded (Advanced Shielding Technology), Plug straight M12, coding: X SPEEDCON / IP67, on Plug straight RJ45 Push Pull / IP67, cable length: 2 m

Commercial Data

Item number	1407480
Packing unit	1 pc
Minimum order quantity	1 pc
Sales Key	C1 - Sensor-Aktor-Kabel
Product Key	BF1CMJ
Catalog Page	Page 403 (C-2-2019)
GTIN	4046356777599
Weight per Piece (including packing)	137,2 g
Weight per Piece (excluding packing)	137,2 g
Customs tariff number	85444210
Country of origin	PL

Technical Data

Notes

General	Further products with variable cable type and variable cable length can be found in the accessories section
---------	---

Product properties

Product type	Data cable preassembled
Number of positions	8
Sensor type	Ethernet
Application	Standard
No. of cable outlets	1
Number of slots	1
Shielded	yes
Coding	X

Interfaces

Bus system	Ethernet
Signal type/category	Ethernet CAT6 _A , 10 Gbps CC-Link IE CAT6 _A , 10 Gbps

Signaling

Status display	No
Status display present	No

Electrical properties

Nominal voltage U_N	48 V AC
	60 V DC
Nominal current I_N	0.5 A
Transmission medium	Copper
Transmission characteristics (category)	CAT6 _A

Material specifications

Color Handle area	black
-------------------	-------

Connector

Connection 1

Type	Plug straight M12 SPEEDCON / IP67
Number of positions	8
Coding type	X (Data)
Handle color	black
Material	CuZn (Contact) Ni/Au (Contact surface) PP (Contact carriers)

NBC-M12MSX/ 2,0-94F/R4QC - Network cable



1407480

<https://www.phoenixcontact.com/de/produkte/1407480>

	TPU, hardly inflammable, self-extinguishing (Grip)
	Zinc die-cast, nickel-plated (Screw connection)
Insertion/withdrawal cycles	≥ 100
Contact resistance	≤ 5 mΩ
Insulation resistance	≥ 100 MΩ
Tightening torque	0.4 Nm
Degree of protection	IP67
Ambient temperature (operation)	-25 °C ... 90 °C
Number of positions	8
Insertion/withdrawal cycles	100

Connection 2

Type	Plug straight RJ45 Push Pull / IP67
Number of positions	8 (8)
Handle color	black
Material	CuSn (Contact) Ni/Au (Contact surface) PC (Contact carriers) PA GF (Housing)
Insertion/withdrawal cycles	≥ 750
Ambient temperature (operation)	-40 °C ... 70 °C
Number of positions	8
Degree of protection	IP67

Cable/line

Cable length	2 m
--------------	-----

Ethernet 10 Gbit [94F]

Dimensional drawing	
Cable weight	42 kg/km
UL AWM Style	20963 (80°C/30 V)
Number of positions	8
Shielded	yes
Cable type	Ethernet 10 Gbit [94F]
Conductor structure	4x2xAWG26/7; S/FTP
Signal runtime	5.13 ns/m
Conductor structure signal line	7x 0.16 mm
AWG signal line	26

NBC-M12MSX/ 2,0-94F/R4QC - Network cable



1407480

<https://www.phoenixcontact.com/de/produkte/1407480>

Conductor cross section	4x 2x 0.14 mm ²
Wire diameter incl. insulation	1.04 mm
External cable diameter	6.4 mm ±0.2 mm
Outer sheath, material	PUR
External sheath, color	water blue RAL 5021
Conductor material	Bare Cu litz wires
Material wire insulation	Foamed PE
Single wire, color	white/blue-blue, white/orange-orange, white/green-green, white/brown-brown
Thickness, outer sheath	0.65 mm
Twisted pairs	2 cores to the pair
Type of pair shielding	Aluminum-lined foil
Overall twist	4 pairs for core
Optical shield covering	70 %
Insulation resistance	≥ 500 MΩ*km
Loop resistance	≤ 290.00 Ω/km
Wave impedance	100 Ω ±5 Ω (at 100 MHz)
Cable capacity	47 nF/km
Nominal voltage, cable	≤ 100 V
Test voltage Core/Core	700 V (50 Hz, 1 min.)
Test voltage Core/Shield	700 V (50 Hz, 1 min.)
Minimum bending radius, fixed installation	4 x D
Minimum bending radius, flexible installation	8 x D
Tensile strength	≤ 100 N
Near end crosstalk attenuation (NEXT)	75.3 dB (with 1 MHz)
	66.3 dB (at 4 MHz)
	61.8 dB (at 8 MHz)
	60.3 dB (at 10 MHz)
	57.2 dB (at 16 MHz)
	55.8 dB (at 20 MHz)
	54.3 dB (at 25 MHz)
	52.8 dB (at 31.25 MHz)
	48.4 dB (at 62.5 MHz)
	45.3 dB (at 100 MHz)
	40.8 dB (at 200 MHz)
	39.3 dB (at 250 MHz)
	38.1 dB (at 300 MHz)
36.3 dB (at 400 MHz)	
34.8 dB (at 500 MHz)	
Power-summated near end crosstalk attenuation (PSNEXT)	72.3 dB (with 1 MHz)
	63.3 dB (at 4 MHz)
	58.8 dB (at 8 MHz)
	57.3 dB (at 10 MHz)
	54.2 dB (at 16 MHz)

NBC-M12MSX/ 2,0-94F/R4QC - Network cable



1407480

<https://www.phoenixcontact.com/de/produkte/1407480>

	52.8 dB (at 20 MHz)
	51.3 dB (at 25 MHz)
	49.9 dB (at 31.25 MHz)
	45.4 dB (at 62.5 MHz)
	42.3 dB (at 100 MHz)
	37.8 dB (at 200 MHz)
	36.3 dB (at 250 MHz)
	35.1 dB (at 300 MHz)
	33.3 dB (at 400 MHz)
	31.8 dB (at 500 MHz)
Return loss (RL)	20 dB (with 1 MHz)
	23 dB (at 4 MHz)
	24.5 dB (at 8 MHz)
	25 dB (at 10 MHz)
	25 dB (at 16 MHz)
	25 dB (at 20 MHz)
	24.2 dB (at 25 MHz)
	23.3 dB (at 31.25 MHz)
	20.7 dB (at 62.5 MHz)
	19 dB (at 100 MHz)
	16.4 dB (at 200 MHz)
	15.6 dB (at 250 MHz)
	15.6 dB (at 300 MHz)
	15.6 dB (at 400 MHz)
	15.6 dB (at 500 MHz)
Shield attenuation	3.1 dB (with 1 MHz)
	5.7 dB (at 4 MHz)
	8 dB (at 8 MHz)
	8.9 dB (at 10 MHz)
	11.2 dB (at 16 MHz)
	12.6 dB (at 20 MHz)
	14.1 dB (at 25 MHz)
	15.8 dB (at 31.25 MHz)
	22.5 dB (at 62.5 MHz)
	28.7 dB (at 100 MHz)
	41.4 dB (at 200 MHz)
	46.6 dB (at 250 MHz)
	51.4 dB (at 300 MHz)
	60.1 dB (at 400 MHz)
	67.9 dB (at 500 MHz)
	≥ 80 dB (at 30 ... 100 MHz)
Halogen-free	according to IEC 60754-1
Flame resistance	according to IEC 60332-1-2
Resistance to oil	in accordance with DIN EN 60811-2-1

NBC-M12MSX/ 2,0-94F/R4QC - Network cable



1407480

<https://www.phoenixcontact.com/de/produkte/1407480>

Ambient temperature (operation)	-40 °C ... 80 °C (cable, fixed installation)
	-20 °C ... 80 °C (Cable, flexible installation)
Ambient temperature (installation)	-20 °C ... 80 °C

Environmental and real-life conditions

Ambient conditions

Degree of protection	IP65 (M12 connector)
	IP67 (M12 connector)
	IP67 (RJ45 connector)
Ambient temperature (operation)	-25 °C ... 90 °C (M12 connector)
	-40 °C ... 70 °C (RJ45 connector)

Standards and regulations

M12

Standards/specifications	IEC 61076-2-109
--------------------------	-----------------

Drawings

Dimensional drawing

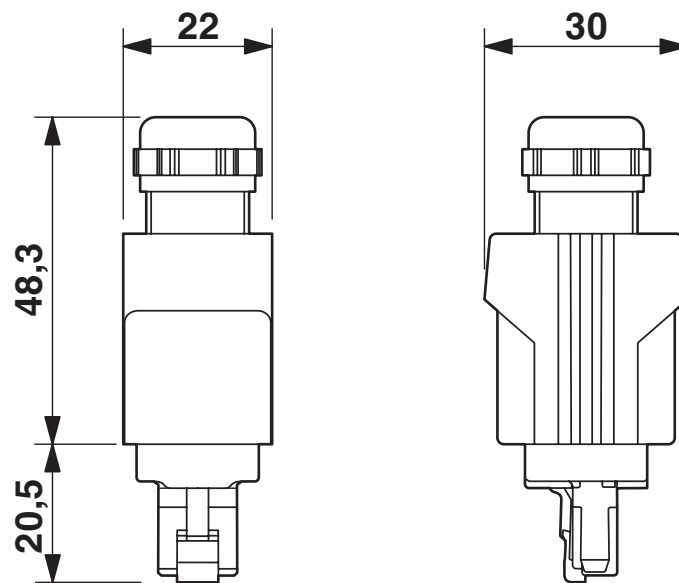

RJ45 Push-Pull connector, IP67

Schematic diagram

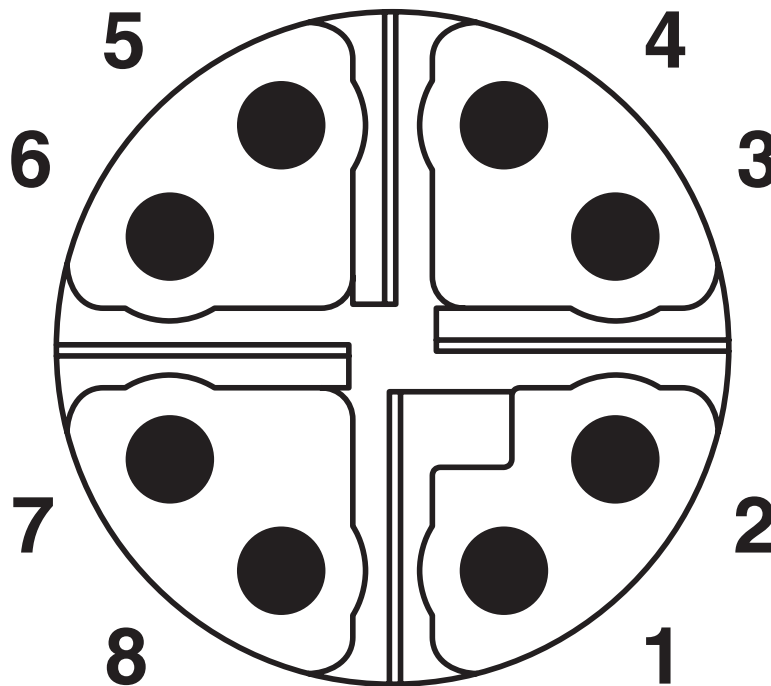

Pin assignment of M12 plug, 8-pos., X-coded, pin side view

Schematic diagram

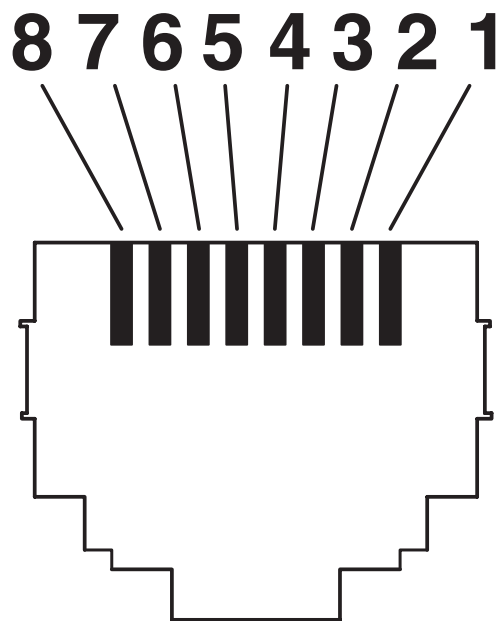

Connector pin assignment plug RJ45

Dimensional drawing

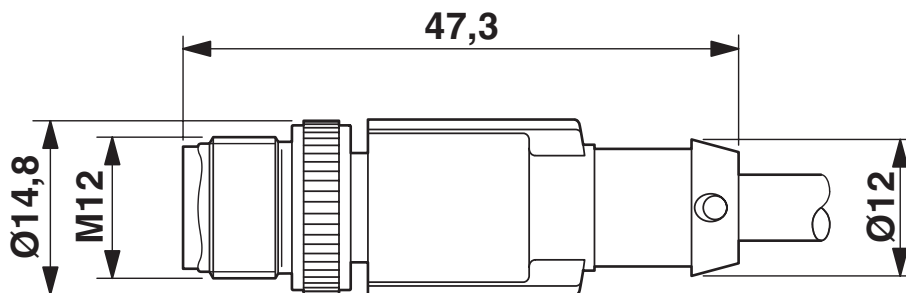

Plug, M12 x 1, straight, shielded

Circuit diagram

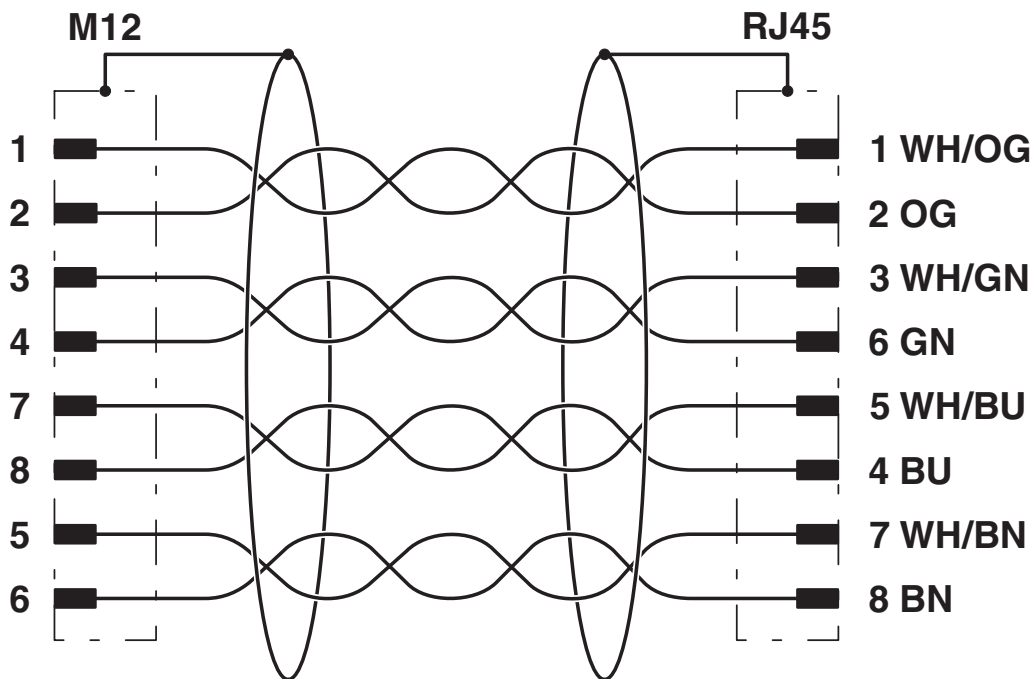

NBC-M12MSX/ 2,0-94F/R4QC - Network cable





1407480

<https://www.phoenixcontact.com/de/produkte/1407480>

Approvals

 UL Listed Approval ID: FILE E 335024				
	Nominal Voltage U_N	Nominal Current I_N	Cross Section AWG	Cross Section mm^2
	30 V	0.5 A	-	-

 cUL Listed Approval ID: FILE E 335024				
	Nominal Voltage U_N	Nominal Current I_N	Cross Section AWG	Cross Section mm^2
	30 V	0.5 A	-	-

 EAC-RoHS Approval ID: RU D-DE.HB35.B.00387	
--	--

NBC-M12MSX/ 2,0-94F/R4QC - Network cable



1407480

<https://www.phoenixcontact.com/de/produkte/1407480>

Classifications

ECLASS

ECLASS-11.0	27060307
ECLASS-12.0	27060307
ECLASS-13.0	27060307

ETIM

ETIM 8.0	EC001855
----------	----------

UNSPSC

UNSPSC 21.0	26121600
-------------	----------

NBC-M12MSX/ 2,0-94F/R4QC - Network cable



1407480

<https://www.phoenixcontact.com/de/produkte/1407480>

Environmental Product Compliance

China RoHS	Environmentally friendly use period: unlimited = EFUP-e
	No hazardous substances above threshold values

NBC-M12MSX/ 2,0-94F/R4QC - Network cable

1407480

<https://www.phoenixcontact.com/de/produkte/1407480>



Accessories

NBC-M12MSX-R4RC-10G/.../... - Network cable

1408646

<https://www.phoenixcontact.com/de/produkte/1408646>



Network cable, Ethernet CAT6_A (10 Gbps), CC-Link IE CAT6_A (10 Gbps), 8-position, Variable cable type, shielded (Advanced Shielding Technology), Plug straight M12, coding: X / IP67, on Plug straight RJ45 Push Pull / IP67, cable length: Free input (0.2 ... 40.0 m)

NBC-M12MSX-R4QC-10G/.../... - Network cable

1408645

<https://www.phoenixcontact.com/de/produkte/1408645>



Network cable, Ethernet CAT6_A (10 Gbps), CC-Link IE CAT6_A (10 Gbps), 8-position, Variable cable type, shielded (Advanced Shielding Technology), Plug straight M12, coding: X / IP67, on Plug straight RJ45 Push Pull / IP67, cable length: Free input (0.2 ... 40.0 m)

NBC-M12MSX/ 2,0-94F/R4QC - Network cable



1407480

<https://www.phoenixcontact.com/de/produkte/1407480>

TSD 04 SAC - Torque screwdriver

1208429

<https://www.phoenixcontact.com/de/produkte/1208429>



Torque screwdriver, with preset torque of 0.4 Nm and 4 mm hexagonal drive for M12 connectors

TSD-M 1,2NM - Torque screwdriver

1212224

<https://www.phoenixcontact.com/de/produkte/1212224>



Torque screw driver, accuracy as per EN ISO 6789 standard, adjustable from 0.3 - 1.2 Nm

NBC-M12MSX/ 2,0-94F/R4QC - Network cable



1407480

<https://www.phoenixcontact.com/de/produkte/1407480>

TSD-M SAC-BIT ADAPTER - Adapter insert

1212600

<https://www.phoenixcontact.com/de/produkte/1212600>



Adapter bit for TSD-M...torque tools, E6.3-1/4" drive with 4 mm hexagon to accommodate SAC bits

SAC BIT M12-D15 - Tool

1208432

<https://www.phoenixcontact.com/de/produkte/1208432>



Nut for assembling sensor/actuator cables with M12 connector and M12 connectors for assembly, with a knurl diameter of 15 mm, for 4 mm hexagonal drive

NBC-M12MSX/ 2,0-94F/R4QC - Network cable



1407480

<https://www.phoenixcontact.com/de/produkte/1407480>

PROT-M12 FS-PA-CHAIN - Sealing cap

1430873

<https://www.phoenixcontact.com/de/produkte/1430873>

M12 sealing cap made of plastic with fixing band, for sensor cables, for free M12 plugs



SAC-M12-EXCLIP-M - Locking clip

1558988

<https://www.phoenixcontact.com/de/produkte/1558988>

Locking clip for the pin side of sensor/actuator cables with M12 connector and M12 connectors for assembly, for knurl diameter: 15 mm or for Allen key with a wrench size of 14 mm, prevents the disconnection of plug-in connections without tools



NBC-M12MSX/ 2,0-94F/R4QC - Network cable



1407480

<https://www.phoenixcontact.com/de/produkte/1407480>

CUTFOX 12 - Cable-cutting tool

1212128

<https://www.phoenixcontact.com/de/produkte/1212128>



Cable cutter, for copper and aluminum up to 12 mm diameter (up to 35 mm²)

CUTFOX-S VDE - Diagonal cutter

1212207

<https://www.phoenixcontact.com/de/produkte/1212207>



Diagonal cutter for hard (piano wire) and soft wires, VDE 1000 V AC/1500 V DC tested

NBC-M12MSX/ 2,0-94F/R4QC - Network cable

1407480

<https://www.phoenixcontact.com/de/produkte/1407480>



VS-CABLE-STRIP-VARIO - Stripping tool

1657407

<https://www.phoenixcontact.com/de/produkte/1657407>

Stripping tool, for the multi-level stripping of shielded cables



MICROFOX-SP-1 - Diagonal cutter

1212487

<https://www.phoenixcontact.com/de/produkte/1212487>

Electronic diagonal cutter, tapered head, without chamfer, with opening spring, non-reflective phosphate-treated surface, punched version



NBC-M12MSX/ 2,0-94F/R4QC - Network cable



1407480

<https://www.phoenixcontact.com/de/produkte/1407480>

WIREFOX 4 - Stripping tool

1212156

<https://www.phoenixcontact.com/de/produkte/1212156>



Stripping tool, for cables and conductors (especially for rubber and silicone insulations) from 0.1 - 4 mm², self-adjusting, stripping length of up to 18 mm, cutting capacity of up to 10 mm² stranded/1.5 mm² solid, replaceable stripping blade

WIREFOX-E 4 - Stripping tool

1212704

<https://www.phoenixcontact.com/de/produkte/1212704>



Stripping tool, for cables and conductors (especially for rubber and silicone insulations) from 0.1 - 4 mm², self-adjusting, stripping length of up to 18 mm, cutting capacity of up to 10 mm² stranded/1.5 mm² solid, replaceable stripping blade

NBC-M12MSX/ 2,0-94F/R4QC - Network cable

1407480

<https://www.phoenixcontact.com/de/produkte/1407480>

WIREFOX 10 - Stripping tool

1212150

<https://www.phoenixcontact.com/de/produkte/1212150>



Stripping tool, for cables and conductors from 0.02 - 10 mm², self-adjusting, stripping length of up to 18 mm, cutting capacity of up to 10 mm² stranded/1.5 mm² solid, replaceable stripping blade

WP-CTA POM 13,0 BK - Protective hose adapter

1422884

<https://www.phoenixcontact.com/de/produkte/1422884>



Protective hose adapter, for corrugated hoses with a nominal size of 13 (10 x 13), corrugated in parallel

NBC-M12MSX/ 2,0-94F/R4QC - Network cable

1407480

<https://www.phoenixcontact.com/de/produkte/1407480>

WP-PA HF 13,0 BK - Protective hose

3240681

<https://www.phoenixcontact.com/de/produkte/3240681>



Protective hose, material: PA 6, UV-resistant: yes, flexible, degree of protection: IP68, color: black, flammability rating in acc. with UL 94: V0, inner diameter: 10 mm, Total length: 50 m

WP-PA HF-HB 13,0 BK - Protective hose

3240839

<https://www.phoenixcontact.com/de/produkte/3240839>



Protective hose, material: PA 6, UV-resistant: yes, flexible, degree of protection: IP68, color: black, flammability rating in acc. with UL 94: HB, inner diameter: 10 mm, Total length: 50 m

NBC-M12MSX/ 2,0-94F/R4QC - Network cable

1407480

<https://www.phoenixcontact.com/de/produkte/1407480>

SACC-M12MSX-8QO SH ETH - Data connector

1411043

<https://www.phoenixcontact.com/de/produkte/1411043>



Data connector, Ethernet CAT6_A (10 Gbps), 8-position, halogen-free, shielded, Plug straight M12, X, Insulation displacement connection, knurl material: Zinc die-cast, nickel-plated, external cable diameter 5 mm ... 9.7 mm

SACC-M12FSX-8QO SH ETH - Data connector

1414586

<https://www.phoenixcontact.com/de/produkte/1414586>



Data connector, Ethernet CAT6_A (10 Gbps), 8-position, halogen-free, shielded, Socket straight M12, X, Insulation displacement connection, knurl material: Zinc die-cast, nickel-plated, external cable diameter 5 mm ... 9.7 mm

NBC-M12MSX/ 2,0-94F/R4QC - Network cable

1407480

<https://www.phoenixcontact.com/de/produkte/1407480>

SACC-CC-8QO SH ETH - Conductor connectors

1414412

<https://www.phoenixcontact.com/de/produkte/1414412>



Cable connector, Ethernet CAT6_A (10 Gbps), 8-pos., halogen-free, shielded, insulation displacement connection, housing material: zinc die-cast, nickel-plated, outer cable diameter of 5 mm ... 9.7 mm

VS-08-M12MS-10G-P SCO - Data connector

1417430

<https://www.phoenixcontact.com/de/produkte/1417430>



Data connector, Ethernet CAT6_A (10 Gbps), 8-position, shielded, Plug straight M12 SPEEDCON, X, Piercecon[®] fast connection, knurl material: Zinc die-cast, nickel-plated, external cable diameter 4 mm ... 8 mm

NBC-M12MSX/ 2,0-94F/R4QC - Network cable

1407480

<https://www.phoenixcontact.com/de/produkte/1407480>

VS-08-M12MR-10G-P SCO - Data connector

1417443

<https://www.phoenixcontact.com/de/produkte/1417443>



Data connector, Ethernet CAT6_A (10 Gbps), 8-position, shielded, Plug angled M12 SPEEDCON, X, Piercecon[®] fast connection, knurl material: Zinc die-cast, nickel-plated, external cable diameter 4 mm ... 8 mm

SACC-M12MSX-8CT-CL SH - Data connector

1422844

<https://www.phoenixcontact.com/de/produkte/1422844>



Data connector, Ethernet CAT6_A (10 Gbps), PROFINET CAT6_A (10 Gbps), 8-position, shielded, Plug straight M12, X, Crimp connection, knurl material: Zinc die-cast, tin-plated, external cable diameter 6.5 mm ... 10 mm, without crimp contacts

NBC-M12MSX/ 2,0-94F/R4QC - Network cable



1407480

<https://www.phoenixcontact.com/de/produkte/1407480>

SACC-M12MRX-8CT-CL SH - Data connector

1422845

<https://www.phoenixcontact.com/de/produkte/1422845>



Data connector, Ethernet CAT6_A (10 Gbps), PROFINET CAT6_A (10 Gbps), 8-position, shielded, Plug angled M12, X, Crimp connection, knurl material: Zinc die-cast, tin-plated, external cable diameter 6.5 mm ... 10 mm, without crimp contacts

VS-08-RJ45-10G/Q - RJ45 connector

1419001

<https://www.phoenixcontact.com/de/produkte/1419001>



RJ45 connector, design: RJ45, degree of protection: IP20, number of positions: 8, 10 Gbps, CAT6_A, material: Plastic, connection method: Insulation displacement connection, cable outlet: straight, color: black, Ethernet

NBC-M12MSX/ 2,0-94F/R4QC - Network cable

1407480

<https://www.phoenixcontact.com/de/produkte/1407480>

CUC-IND-C1ZNI-S/R4IE8 - RJ45 connector

1421607

<https://www.phoenixcontact.com/de/produkte/1421607>



RJ45 connector, design: RJ45, degree of protection: IP20, number of positions: 8, 1 Gbps, CAT5, material: Metal, connection method: Insulation displacement connection, cable outlet: straight, color: green, Ethernet

CUC-IND-C1ZNI-T/R4IE8 - RJ45 connector

1421877

<https://www.phoenixcontact.com/de/produkte/1421877>



RJ45 connector, design: RJ45, degree of protection: IP20, number of positions: 8, 1 Gbps, CAT5, material: Metal, connection method: Insulation displacement connection, cable outlet: angled, Ethernet

NBC-M12MSX/ 2,0-94F/R4QC - Network cable



1407480

<https://www.phoenixcontact.com/de/produkte/1407480>

CUC-IND-C1ZNI-B/R4IE8 - RJ45 connector

1421876

<https://www.phoenixcontact.com/de/produkte/1421876>



RJ45 connector, design: RJ45, degree of protection: IP20, number of positions: 8, 1 Gbps, CAT5, material: Metal, connection method: Insulation displacement connection, cable outlet: angled, Ethernet

CUC-V06-C1PGY-S/R4CEA:1 - RJ45 connector

1414406

<https://www.phoenixcontact.com/de/produkte/1414406>



RJ45 connector, design: RJ45, degree of protection: IP67, number of positions: 2, 10 Gbps, CAT6_A, material: Plastic, connection method: Crimp connection, connection cross section: AWG 24- 27, cable outlet: straight, color: gray, Ethernet/PROFINET

NBC-M12MSX/ 2,0-94F/R4QC - Network cable



1407480

<https://www.phoenixcontact.com/de/produkte/1407480>

CUC-V06-C1PBK-S/R4CEA:1 - RJ45 connector

1414410

<https://www.phoenixcontact.com/de/produkte/1414410>



RJ45 connector, design: RJ45, degree of protection: IP67, number of positions: 8, 10 Gbps, CAT6_A, material: Plastic, connection method: Crimp connection, connection cross section: AWG 24- 27, cable outlet: straight, color: black, Ethernet/PROFINET

VS-PPC-C1-RJ45-POBK-8I10G - RJ45 connector

1422205

<https://www.phoenixcontact.com/de/produkte/1422205>



RJ45 connector, degree of protection: IP65/IP67, number of positions: 8, 10 Gbps, CAT6_A, material: Plastic, connection method: Crimp connection, connection cross section: AWG 27- 24, cable outlet: straight, color: black, Ethernet

Phoenix Contact 2023 © - all rights reserved
<https://www.phoenixcontact.com>

PHOENIX CONTACT Deutschland GmbH
Flachsmarktstraße 8
D-32825 Blomberg
+49 52 35/3-1 20 00
info@phoenixcontact.de