

XS1N12NA349D

Inductive proximity sensors XS, inductive sensor XS1 M12, L50mm, brass, Sn4mm, 12...24 VDC, M12



Main

Range of product	Telemecanique Inductive proximity sensors XS
Series name	General purpose
Sensor type	Inductive proximity sensor
Device application	-
Sensor name	XS1
Sensor design	Cylindrical M12
Size	50 mm
Body type	Fixed
Detector flush mounting acceptance	Flush mountable
Material	Metal
Enclosure material	Nickel plated brass
Type of output signal	Discrete
Wiring technique	3-wire
[Sn] nominal sensing distance	4 mm
Discrete output function	1 NO
Output circuit type	DC
Discrete output type	NPN
Electrical connection	Male connector M12, 4 pins
[Us] rated supply voltage	12...24 V DC with reverse polarity protection
Switching capacity in mA	<= 200 mA DC with overload and short-circuit protection
IP degree of protection	IP67 conforming to IEC 60529 IP69K conforming to DIN 40050

Complementary

Thread type	M12 x 1
Detection face	Frontal
Front material	PPS
Operating zone	0...3.2 mm
Differential travel	1...15% of Sr
Status LED	Output state: 1 LED (yellow)
Supply voltage limits	10...36 V DC
Switching frequency	<= 2500 Hz
Maximum voltage drop	<2 V (closed)
Current consumption	0...10 mA no-load
Maximum delay first up	5 ms
Maximum delay response	0.2 ms
Maximum delay recovery	0.2 ms
Marking	CE
Threaded length	30 mm
Height	12 mm
Length	50 mm
Net weight	0.02 kg

Environment

Product certifications	CSA UL
Ambient air temperature for operation	-25...50 °C
Ambient air temperature for storage	-40...85 °C
Vibration resistance	25 gn amplitude = +/- 2 mm (f = 10...55 Hz) conforming to IEC 60068-2-6
Shock resistance	50 gn for 11 ms conforming to IEC 60068-2-27

Packing Units

Unit Type of Package 1	PCE
Number of Units in Package 1	1
Package 1 Height	1.7 cm
Package 1 Width	5.5 cm
Package 1 Length	15.4 cm
Package 1 Weight	28 g
Unit Type of Package 2	S01
Number of Units in Package 2	22
Package 2 Height	15 cm
Package 2 Width	15 cm
Package 2 Length	40 cm
Package 2 Weight	1.023 kg
Package 3 Height	15 cm

Offer Sustainability

Sustainable offer status	Green Premium product
REACH Regulation	REACH Declaration
EU RoHS Directive	Pro-active compliance (Product out of EU RoHS legal scope) EU RoHS Declaration
Mercury free	Yes
RoHS exemption information	Yes
Environmental Disclosure	Product Environmental Profile
Circularity Profile	End Of Life Information

Contractual warranty

Warranty	18 months
----------	-----------

Dimensions

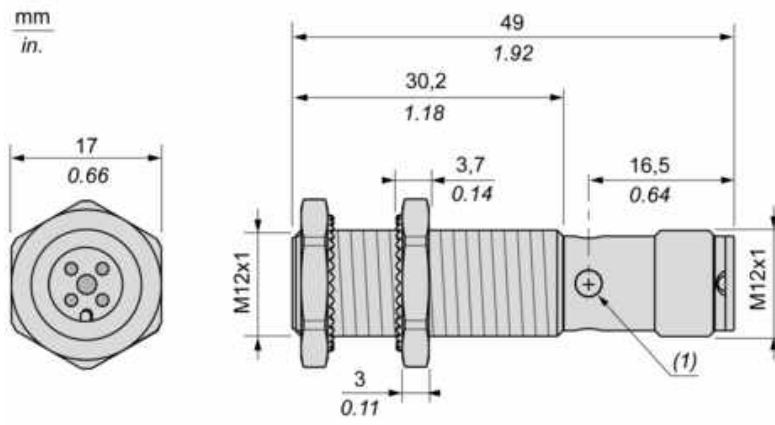

(1) : LED

Minimum Mounting Distances in mm

Side by side

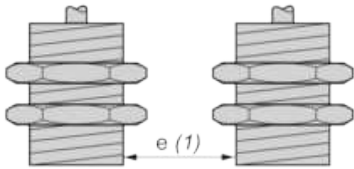

$e(1) \geq 8 \text{ mm}/0.31 \text{ in.}$

Face to face

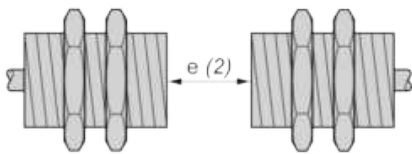

$e(2) \geq 48 \text{ mm}/1.89 \text{ in.}$

Facing a metal object

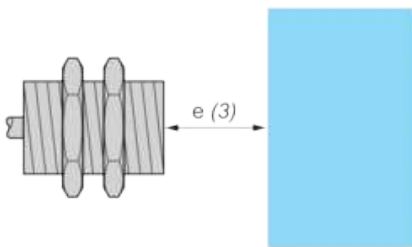

$e(3) \geq 12 \text{ mm}/0.47 \text{ in.}$

Mounted in a metal support

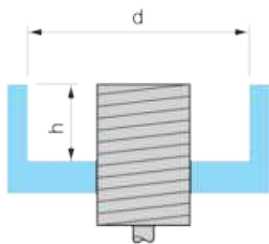

$d \geq 14 \text{ mm}/0.55 \text{ in.}$

$h \geq 2.4 \text{ mm}/0.09 \text{ in}$

Wiring Schemes

M8 Connector

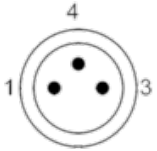

NPN

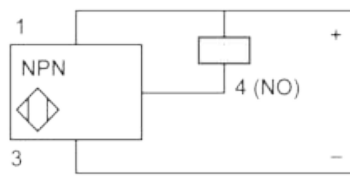

Performance Curves

Standard Steel Target : 12x12x1 mm

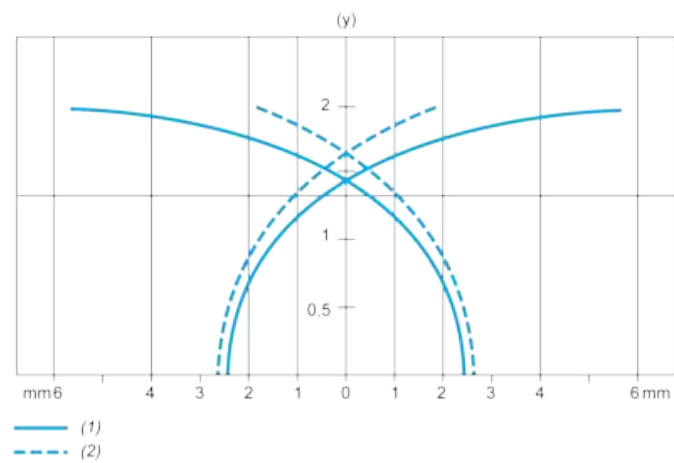

(1) Pick-up points

(2) Drop-out points (object approaching from the side)

(y) Sensing distance in mm