

Long Distance Reflective Switch

OPB732, OPB732WZ



Features:

- PC board mounting (OPB732)
- 24" (610 mm) 26 AWG wired with mounting tabs (OPB732WZ)
- Non-contact infrared switch
- Up to 1" or more reflective distance depending on circuitry

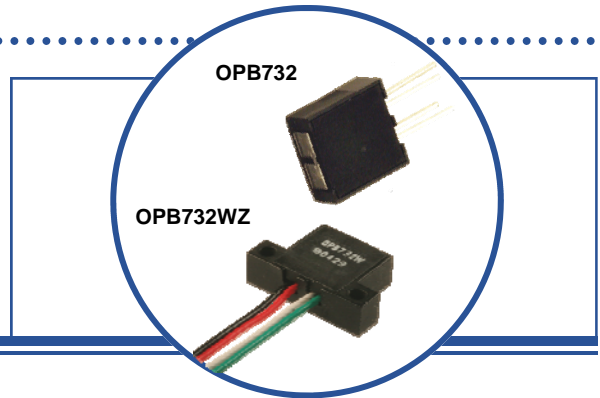

Description:

OPB732 uses an Infrared LED and Phototransistor in a reflective switch configuration. The assembly is offered with either PCBoard through hole pins (**OPB732**) or 24" (610 mm), 26 AWG wires (**OPB732WZ**), and uses an opaque housing to reduce the sensor's ambient light sensitivity. The emitter and sensor are protected by a clear window, providing a device that can operate in a dusty environment. The phototransistor can be configured as a Common Collector or Common Emitter device.

While an object is in the reflective path of the device, light from the LED will be reflected back to the housing irradiating the surface (base) of the phototransistor. When Infrared light strikes the phototransistor, the transistor becomes forward biased and is considered to be in the "ON" state, providing an $I_{C(ON)}$ current proportional to the light striking the phototransistor. With the Infrared light from the LED not being reflected to the phototransistor, the phototransistor turns "OFF," minimizing the $I_{C(ON)}$ current.

Custom electrical, wire and cabling and connectors are available. Contact your local representative or OPTEK for more information.

Applications:

- Non-contact reflective object sensor
- Assembly line automation
- Machine automation
- Equipment security
- Door sensor
- Machine safety
- End of travel sensor

Ordering Information		
Part Number	LED Peak Wavelength	Lead Length / Spacing
OPB732	850 nm	0.150" / see diagram
OPB732WZ		24" / 26 AWG Wire

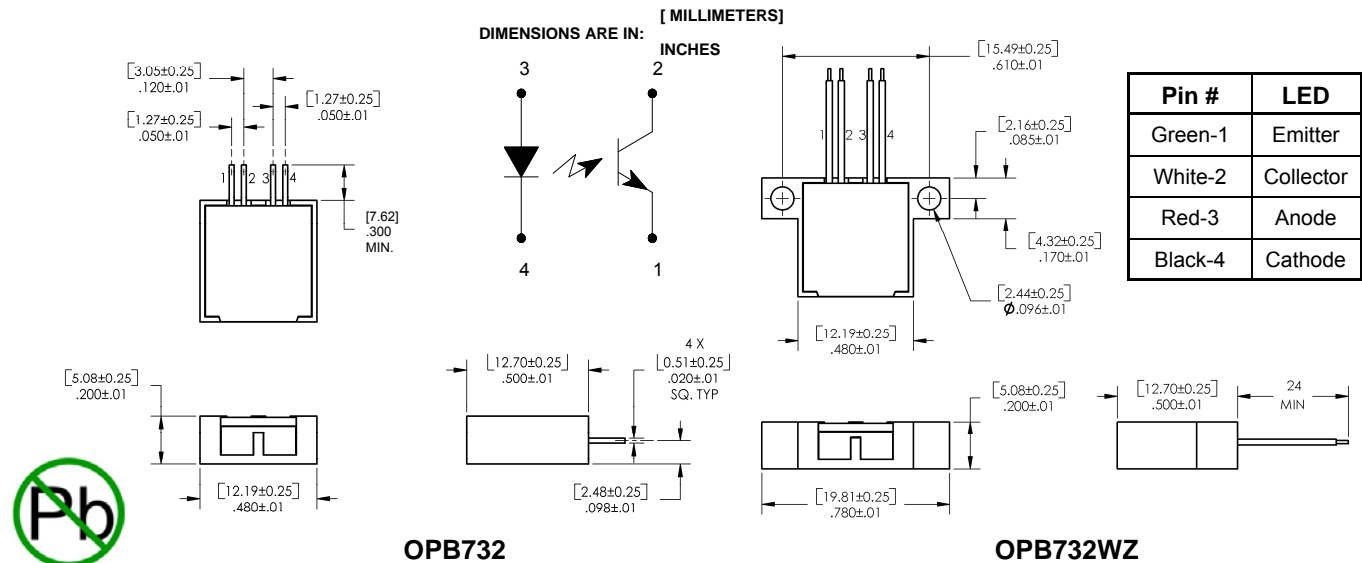

RoHS

OPTEK reserves the right to make changes at any time in order to improve design and to supply the best product possible.

Absolute Maximum Ratings ($T_A = 25^\circ\text{C}$ unless otherwise noted)

Storage Temperature	-40° C to +100° C
Operating Temperature	-40° C to +85° C
Lead Soldering Temperature (1/16" (1.6mm) from case for 5 seconds with soldering iron) ⁽²⁾	260° C

LED

Forward Current	50 mA
Peak Forward current (2 μs pulse width, 0.1% Duty Cycle)	1 A
Reverse DC Voltage	3 V
Power Dissipation	100 mW

Output Photo Transistor

Collector-Emitter Voltage	30 V
Collector DC Current	50 mA
Power Dissipation	100 mW

Electrical Characteristics ($T_A = 25^\circ\text{C}$ unless otherwise noted)

SYMBOL	PARAMETER	MIN	TYP	MAX	UNITS	CONDITIONS
--------	-----------	-----	-----	-----	-------	------------

Input LED (See OP265 for additional information, reference only)

V_F	Forward Voltage	-	-	1.8	V	$I_F = 20\text{ mA}$
I_R	Reverse Current	-	-	100	μA	$V_R = 2\text{ V}$

Output Phototransistor (See OP505 for additional information, reference only)

$V_{(BR)CEO}$	Collector-Emitter Breakdown Voltage	30	-	-	V	$I_C = 100\ \mu\text{A}$, $E_E = 0\text{ mw/cm}^2$
I_{CEO}	Collector-Emitter Dark Current	-	-	100	nA	$V_{CE} = 10\text{ V}$, $E_E = 0\text{ mw/cm}^2$

Coupled

$V_{CE(SAT)}$	Collector-Emitter Saturation Voltage ⁽⁴⁾	-	-	0.4	V	$I_C = 250\ \mu\text{A}$, $I_F = 30\text{ mA}$, (4)
$I_{C(ON)}$	On-State Collector Current ⁽⁴⁾	0.25	-	-	mA	$V_{CE} = 1\text{ V}$, $I_F = 30\text{ mA}$, (4)
I_{CX}	Cross Talk	-	-	50	μA	$V_{CE} = 5\text{ V}$, $I_F = 30\text{ mA}$, No reflective surface

Notes:

- (1) All parameters tested using pulse technique.
- (2) RMA flux is recommended. Duration can be extended to 10 seconds maximum when flow soldering.
- (3) Methanol or isopropanol are recommended as cleaning agents. The plastic housing is soluble in chlorinated hydrocarbons and keytones.
- (4) Distance = 1" (from front of package to a 90% diffuse reflective white card)

OPTEK reserves the right to make changes at any time in order to improve design and to supply the best product possible.

$I_{C(ON)}$ vs Distance ($I_F=30mA$)

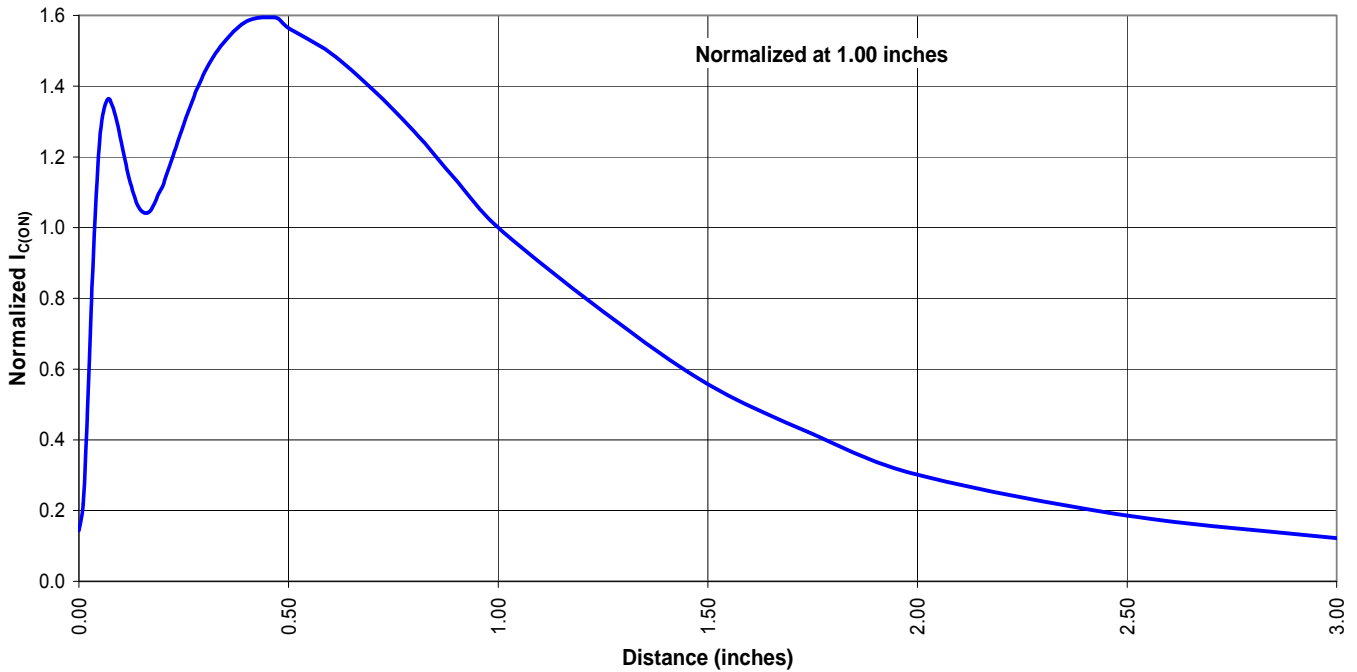

DC—Drive Circuit for LED & Phototransistor

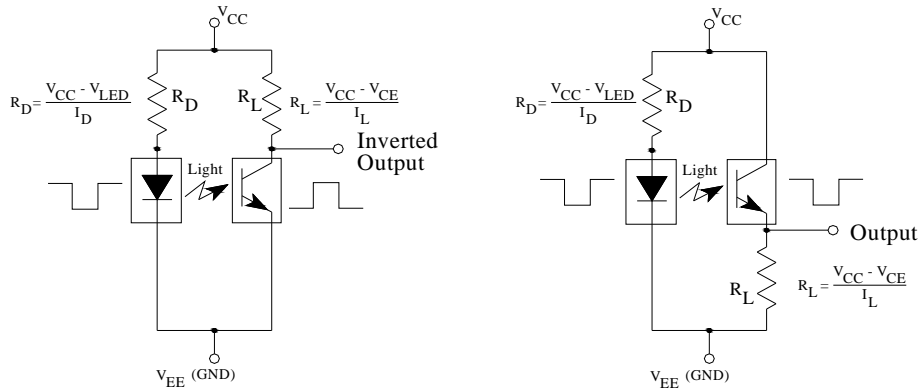

Pulsed—Drive Circuit for LED & Phototransistor

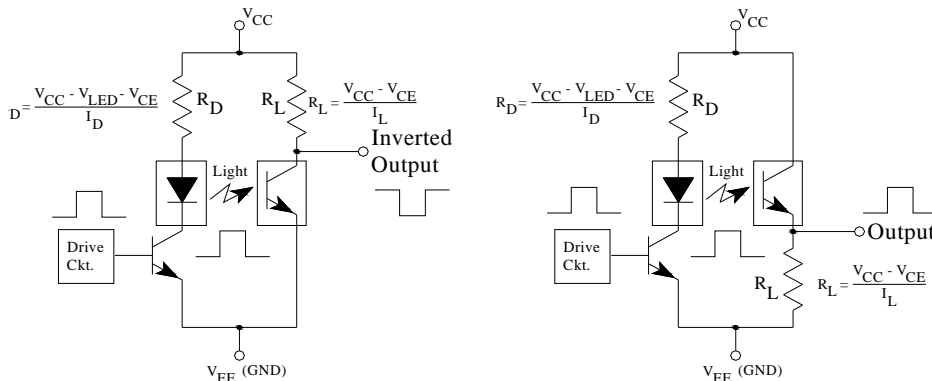

OPTEK reserves the right to make changes at any time in order to improve design and to supply the best product possible.