

LSTTL TO

TTL BUFFER	74OL6000
TTL INVERTER	74OL6001
CMOS BUFFER	74OL6010
CMOS INVERTER	74OL6011

PACKAGE

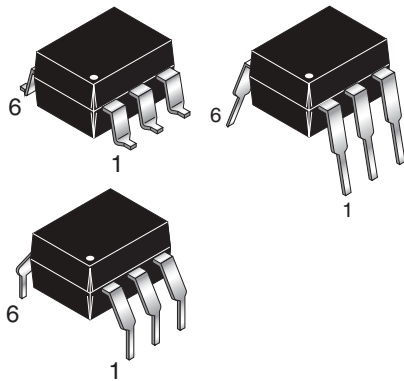

SYMBOL

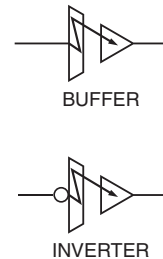

DESCRIPTION

OPTOLOGIC™ is the first family of truly logic compatible optically coupled logic interface gates.

The family consists of four device types offering LSTTL to TTL and LSTTL to CMOS interfacing. Each of these interfacing functions is available as a buffer ($A=B$), or as an inverter ($A=\bar{B}$).

The LSTTL input compatibility is provided by an input integrated circuit, with industry standard logic levels. This input amplifier IC switches a temperature compensated current source driving a high speed 850 nm AlGaAs LED emitter. This novel integration scheme eliminates CTR degradation over time and temperature.

The emitter is optically coupled to an integrated photodetector/high-gain, high-speed output amplifier IC. The superior 15kV/μS common-mode noise rejection is ensured through the use of an optically transparent noise shield.

The TTL compatible output has a totem-pole with a fan-out of 10. The CMOS compatible output has an open collector Schottky-clamped transistor that interfaces to any CMOS logic between 4.5 and 15 volts. The 74OL6010/11 may also be used to drive power MOSFETS or transistors up to 15 volts.

The Optologic coupler family typically offers propagation of delays of 60 ns and can support 15 MBaud data communication.

The two input chips and the output chip are assembled in a 6-pin DIP high insulation voltage plastic package. Fairchild's proprietary OPTOPLANAR® construction provides a withstand test voltage of 5300 VRMS (1 minute).

FEATURES

- Industry first LSTTL to TTL and LSTTL to CMOS complete logic-to-logic optocoupler
- Incorporates LED drive circuitry — use as logic gate
- Very high speed
- Choice of buffer or inverter
- Choice of TTL or CMOS compatible output up to 15 volts
- Fan-out of 10 TTL loads, fan-in 1 LSTTL load
- Internal noise shield — very high CMR of ±15 kV/μS
- UL recognized (File #E90700)
- Same noise immunity as LSTTL/TTL.

APPLICATIONS

- Transmission line interface — receiver and driver
- Excellent as bridged receiver in fast LAN highways
- Bus interface
- Logic family interface with ground loop noise elimination
- High speed AC/DC voltage sensing
- Driver for power semiconductor devices
- Level shifting
- Replaces fast pulse transformers

LSTTL TO

TTL BUFFER	74OL6000
TTL INVERTER	74OL6001
CMOS BUFFER	74OL6010
CMOS INVERTER	74OL6011

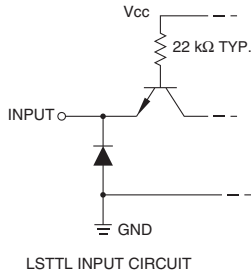

All Inputs

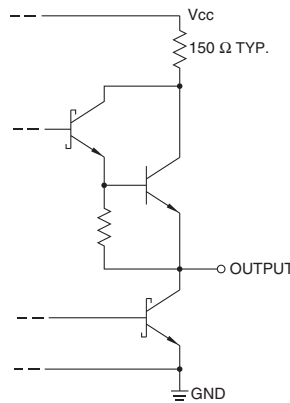

TTL OUTPUT CIRCUIT
74OL6000/01 Output

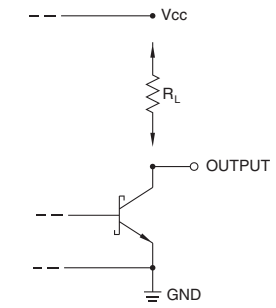

74OL6010/11 Output

PIN CONFIGURATION	
1- V_{CCI} (Input V_{CC})	6- V_{CCO} (Output V_{CC})
2- V_{IN} (Data In)	5- V_O (Data Out)
3-GND, (Input GND)	4-GND _O (Output GND)

DEVICE CONFIGURATION				
Part Number	Logic Compatibility		Logic Function	Output Configuration
	Input	Output		
74OL 6000	LSTTL	TTL	BUFFER	TOTEM POLE
74OL 6001	LSTTL	TTL	INVERTER	TOTEM POLE
74OL 6010	LSTTL	CMOS	BUFFER	OPEN COLLECTOR
74OL 6011	LSTTL	CMOS	INVERTER	OPEN COLLECTOR

LSTTL TO

TTL BUFFER	74OL6000
TTL INVERTER	74OL6001
CMOS BUFFER	74OL6010
CMOS INVERTER	74OL6011

SCHEMATIC

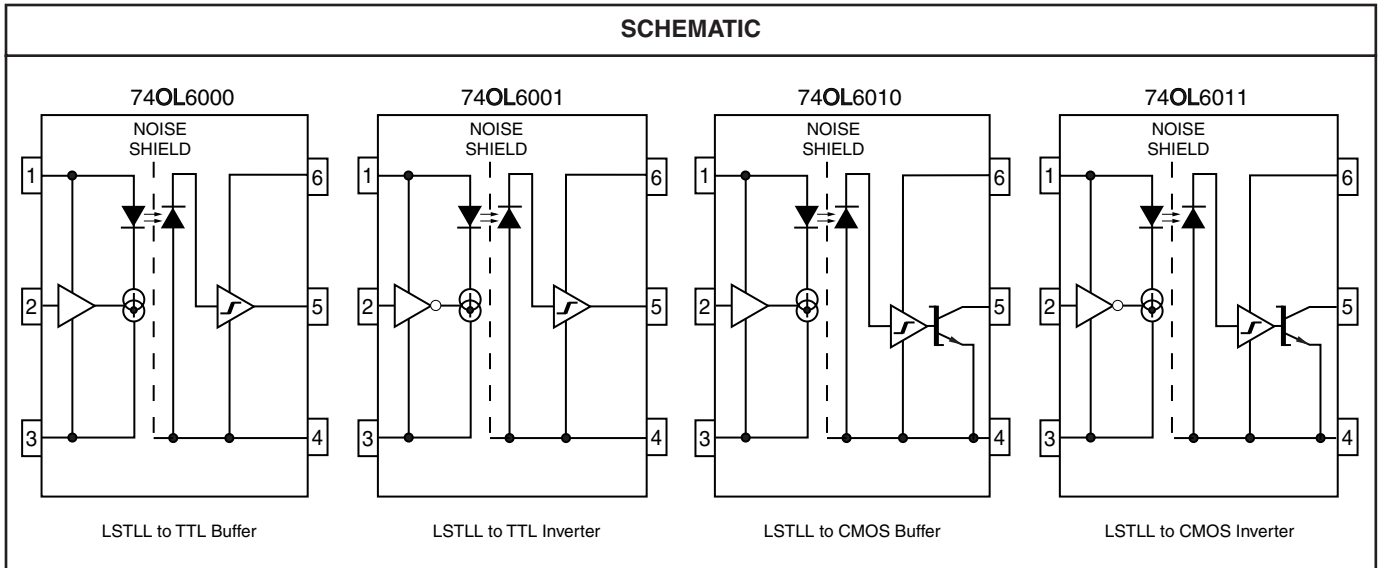

LSTTL TO

TTL BUFFER	74OL6000
TTL INVERTER	74OL6001
CMOS BUFFER	74OL6010
CMOS INVERTER	74OL6011

ELECTRICAL CHARACTERISTICS ($T_A = 0^\circ\text{C}$ to 70°C Unless otherwise specified)

Parameter	Symbol	Min	Typ*	Max	Units	Test Conditions			Notes
						74OL6000	74OL6001	74OL6000/01	
TTL OUTPUT 74OL6000/01									
Input Supply Voltage	V_{CCI}	4.5	5.0	5.5	V				1
Output Supply Voltage	V_{CCO}	4.5	5.0	5.5	V				1
High-Level Input Voltage	V_{IH}	2.0			V				1
Low-Level Input Voltage	V_{IL}			0.8	V				1
Input Clamp Voltage	V_{IK}			-1.2	V			$V_{CCI} = 4.5\text{ V}, I_I = -18\text{ mA}$	1
High-Level Input Current	I_{IH}		1.0	40.0	μA			$V_{CCI} = 5.5\text{ V}, V_{IH} = 4.5\text{ V}$	1
Low-Level Input Current	I_{IL}		-200.0	-400.0	μA			$V_{CCI} = 5.5\text{ V}, V_{IL} = 0.4\text{ V}$	1
Input Supply Current (high)	I_{CCIH}		10.0	14.0	mA			$V_{CCI} = 5.5\text{ V}, V_{IN} = V_{IH}$	1
Input Supply Current (low)	I_{CCIL}		10.0	14.0	mA			$V_{CCI} = 5.5\text{ V}, V_{IN} = V_{IL}$	1
High-Level Output Voltage	V_{OH}	2.4	3.0		V	$V_{IN} = 2.0\text{ V}$	$V_{IN} = 0.8\text{ V}$	$V_{CCI} = 4.5\text{ V}, V_{CCO} = 4.5\text{ V}, I_{OH} = -400\text{ mA}$	1
Low-Level Output Voltage	V_{OL}		0.6		V	$V_{IN} = 0.8\text{ V}$	$V_{IN} = 2.0\text{ V}$	$V_{CCI} = 4.5\text{ V}, V_{CCO} = 4.5\text{ V}, I_{OL} = 16\text{ mA}$	1
			0.5	$V_{CCI} = 4.5\text{ V}, V_{CCO} = 4.5\text{ V}, I_{OL} = 4\text{ mA}$					
High-Level Output Current	I_{OH}		-8.0	-10.0	mA	$V_{IN} = V_{IH}$	$V_{IN} = V_{IL}$	$V_{CCI} = 4.5\text{ V}, V_{CCO} = 4.5\text{ V}, V_{OH} = 2.4\text{ V}$	1
Low-Level Output Current	I_{OL}	16.0			mA	$V_{IN} = 0.8\text{ V}$	$V_{IN} = 2.0\text{ V}$	$V_{CCI} = 4.5\text{ V}, V_{CCO} = 4.5\text{ V}, V_{OL} = 0.6\text{ V}$	1
Short-Circuit Output Current	I_{OS}	-5.0	-25.0	-40.0	mA	$V_{IN} = V_{IH}$	$V_{IN} = V_{IL}$	$V_{CCI} = 5.5\text{ V}, V_{CCO} = 5.5\text{ V}$	1
Output Supply Current (high)	I_{CCOH}		9.0	15.0	mA	$V_{IN} = V_{IH}$	$V_{IN} = V_{IL}$	$V_{CCI} = 5.5\text{ V}, V_O = V_{OH}, V_{CCO} = 5.5\text{ V}$	1
Output Supply Current (low)	I_{CCOL}		8.0	12.0	mA	$V_{IN} = V_{IL}$	$V_{IN} = V_{IH}$	$V_{CCI} = 5.5\text{ V}, V_O = V_{OL}, V_{CCO} = 5.5\text{ V}$	1

*All typical values are at $T_A = 25^\circ\text{C}$

SWITCHING CHARACTERISTICS ($T_A = 25^\circ\text{C}$ Unless otherwise specified)

Parameter	Symbol	Min	Typ	Max	Units	Test Conditions	Fig.	Notes
TTL OUTPUT 74OL6000/01								
Propagation Delay Time For Output Low Level	t_{PHL}		60	100	ns	$V_{CCI} = 5\text{ V}, V_{CCO} = 5\text{ V}$	15, 17	1
Propagation Delay Time For Output High Level	t_{PLH}		70	100	ns		15, 17	1
Output Rise Time For Output High Level	t_r		45		n		15, 17	1
Output Fall Time For Output Low Level	t_f		5		ns		15, 17	1

LSTTL TO

TTL BUFFER	74OL6000
TTL INVERTER	74OL6001
CMOS BUFFER	74OL6010
CMOS INVERTER	74OL6011

ELECTRICAL CHARACTERISTICS ($T_A = 0^\circ\text{C}$ to 70°C Unless otherwise specified)

Parameter	Symbol	Min	Typ*	Max	Units	Test Conditions			Notes
						74OL6010	74OL6011	74OL6010/11	
CMOS OUTPUT 74OL6010/11									
Input Supply Voltage	V_{CCI}	4.5	5.0	5.5	V				1
Output Supply Voltage	V_{CCO}	4.5		15.0	V				1,3
High-Level Input Voltage	V_{IH}	2.0			V				1
Low-Level Input Voltage	V_{IL}			0.8	V				1
Input Clamp Voltage	V_{IK}			-1.2	V			$V_{CCI} = 4.5\text{ V}, I_I = -18\text{ mA}$	1
High-Level Input Current	I_{IH}		1.0	40.0	μA			$V_{CCI} = 5.5\text{ V}, V_{IH} = 4.5\text{ V}$	1
Low-Level Input Current	I_{IL}		-200.0	-400.0	μA			$V_{CCI} = 5.5\text{ V}, V_{IL} = -0.4\text{ V}$	1
Input Supply Current (high)	I_{CCIH}		10.0	14.0	mA			$V_{CCI} = 5.5\text{ V}, V_{IN} = V_{IH}$	1
Input Supply Current (low)	I_{CCIL}		10.0	14.0	mA			$V_{CCI} = 5.5\text{ V}, V_{IN} = V_{IL}$	1
Low-Level Output Voltage	V_{OL}	0.4	0.6	100.0	V	$V_{IN} = 0.8\text{ V}$	$V_{IN} = 2.0\text{ V}$	$V_{CCI} = 4.5\text{ V}, V_{CCO} = 4.5\text{ V}, I_{OL} = 16\text{ mA}$	1
			0.5					$V_{CCI} = 4.5\text{ V}, V_{CCO} = 4.5\text{ V}, I_{OL} = 4\text{ mA}$	
High-Level Output Current	I_{OH}		1.0		μA	$V_{IN} = V_{IH}$	$V_{IN} = V_{IL}$	$V_{CCI} = 4.5\text{ V}, V_{OH} = 15\text{ V}, V_{CCO} = 4.5 - 15\text{ V}$	1
Low-Level Output Current	I_{OL}	16.0			mA	$V_{IN} = 0.8\text{ V}$	$V_{IN} = 2.0\text{ V}$	$V_{CCI} = 4.5\text{ V}, V_{OL} = 0.6\text{ V}, V_{CCO} = 4.5 - 15\text{ V}$	1
Output Supply Current (high)	I_{CCOH}		9.0	12.0	mA	$V_{IN} = V_{IH}$	$V_{IN} = V_{IL}$	$V_{CCI} = 5.5\text{ V}, V_O = V_{OH}, V_{CCO} = 4.5\text{ V}$	1
			11.0	18.0				$V_{CCI} = 5.5\text{ V}, V_O = V_{OL}, V_{CCO} = 15\text{ V}$	
Output Supply Current (low)	I_{CCOL}		8.0	12.0	mA	$V_{IN} = V_{IL}$	$V_{IN} = V_{IH}$	$V_{CCI} = 5.5\text{ V}, V_O = V_{OL}, V_{CCO} = 4.5\text{ V}$	1
			11.0	18.0				$V_{CCI} = 5.5\text{ V}, V_O = V_{OL}, V_{CCO} = 15\text{ V}$	

*All typical values are at $T_A = 25^\circ\text{C}$

SWITCHING CHARACTERISTICS ($T_A = 25^\circ\text{C}$ Unless otherwise specified)

Parameter	Symbol	Min	Typ	Max	Units	Test Conditions	Fig.	Notes
TTL OUTPUT 74OL6010/11								
Propagation Delay Time For Output Low Level	t_{PHL}		60	120	ns	$V_{CCI} = 5\text{ V}, V_{CCO} = 5\text{ V}, R_L = 470\ \Omega$	15, 18	1
Propagation Delay Time For Output High Level	t_{PLH}		100	180	ns		15, 18	1
Output Rise Time For Output High Level	t_r		50		ns		15, 18	1
Output Fall Time For Output Low Level	t_f		5		ns		15, 18	1

LSTTL TO	TTL BUFFER	74OL6000
	TTL INVERTER	74OL6001
	CMOS BUFFER	74OL6010
	CMOS INVERTER	74OL6011

ABSOLUTE MAXIMUM RATINGS ($T_A = 25^\circ\text{C}$ unless otherwise specified)

Parameter	Symbol	Device	Value	Units
TOTAL DEVICE				
Storage Temperature	T_{STG}	All	-55 to +125	$^\circ\text{C}$
Operating Temperature	T_{OPR}	All	0 to +70	$^\circ\text{C}$
Lead Solder Temperature	T_{SOL}	All	260 for 10 sec	$^\circ\text{C}$
Power Dissipation	P_D	All	350	mW
EMITTER				
Input Supply Voltage	V_{CCI}	All	7	V
Input Voltage	V_{IN}	All	7	V
DETECTOR				
Average Output Current	I_O (avg)	All	40	mA
Output Supply Voltage	V_{CCO}	74OL6000/01	7	V
		74OL6010/11	18	
Output Voltage	V_O	74OL6000/01	7	V
		74OL6010/11	18	

ELECTRICAL CHARACTERISTICS ($T_A = 0^\circ\text{C}$ to 70°C Unless otherwise specified)

Parameter	Symbol	Min	Typ	Max	Units	Test Conditions	Fig.	Notes
74OL6000/01/10/11								
Common Mode Transient Immunity at Logic High Level Output	CM_H	5000	15000		V/ μS	$V_{CCI} = 5\text{ V}, V_{CCO} = 5\text{ V}, V_{CM} = 50\text{ Vp-p}$	16, 19	
Common Mode Transient Immunity at Logic Low Level Output	CM_L	-5000	-15000		V/ μS		16, 19	
Common Mode Coupling Capacitance	C_{CM}		0.005		pF			
Capacitance (input-output)	C_{I-O}		0.7		pF	$V_{I-O} = 0, f = 1\text{ MHz}$		2
Withstand Insulation Test Voltage	V_{ISO}	5300			VRMS	$T_A = 25^\circ\text{C}, t = 1\text{ min}, I_{I-O} \leq 1\text{ mA}$		2
Insulation Resistance	R_{ISO}		10^{11}		Ω	$V_{I-O} = 500\text{ VDC}$		2

LSTTL TO

TTL BUFFER	74OL6000
TTL INVERTER	74OL6001
CMOS BUFFER	74OL6010
CMOS INVERTER	74OL6011

Figure 1. Input Current vs. Ambient Temperature

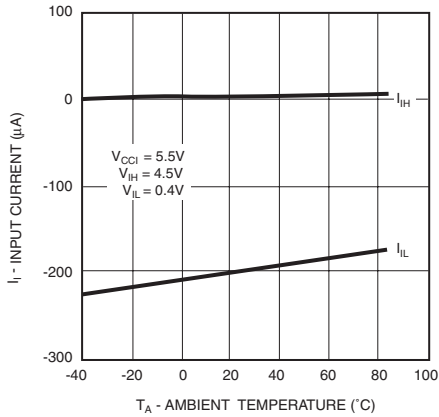

Figure 2. Input Supply Current vs. Ambient Temperature

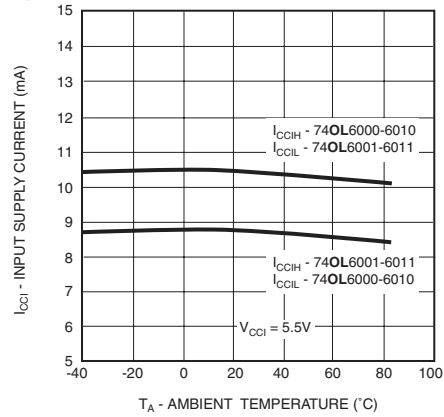

Figure 3. Output Supply Current vs. Ambient Temperature

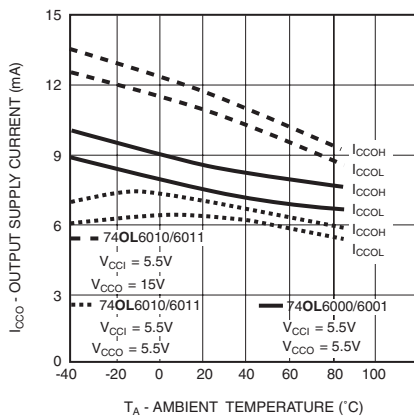

Figure 4. Output Current vs. Ambient Temperature

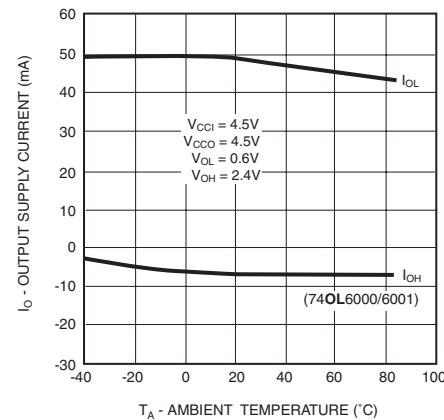

Figure 5. High-Level Output Voltage vs. Ambient Temperature

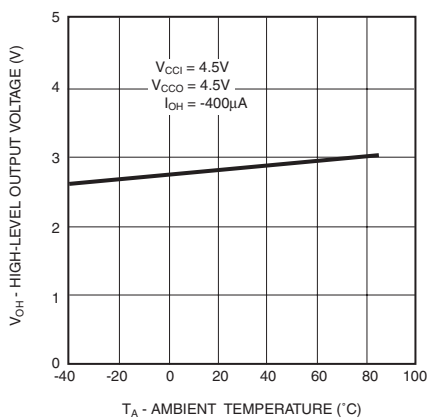
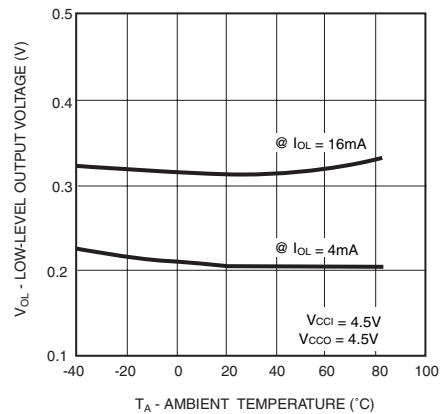

Figure 6. Low-Level Output Voltage vs. Ambient Temperature



LSTTL TO

TTL BUFFER	74OL6000
TTL INVERTER	74OL6001
CMOS BUFFER	74OL6010
CMOS INVERTER	74OL6011

Figure 7. 74OL6010/11 Leakage Current vs. Ambient Temperature

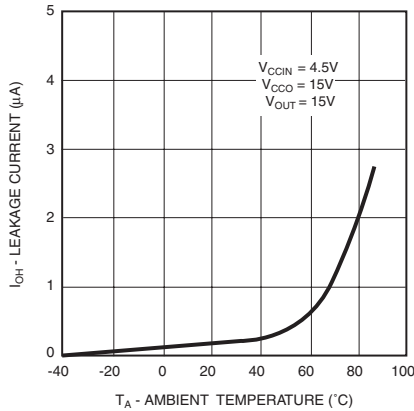

Figure 8. 74OL6000/01 Switching Times vs. Ambient Temperature

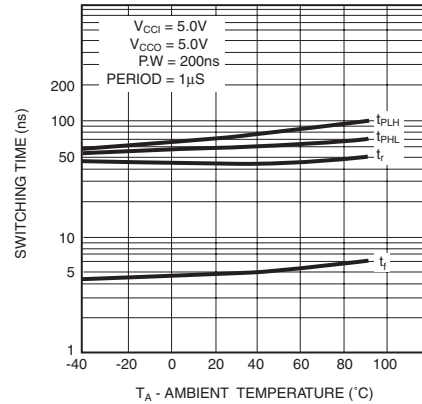

Figure 9. 74OL6010/11 Switching Times vs. Ambient Temperature

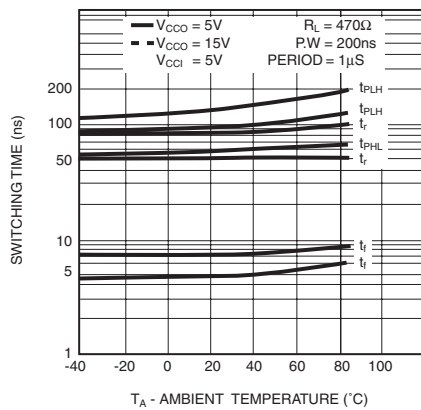

Figure 10. Common Mode Rejection vs. Common Mode Voltage

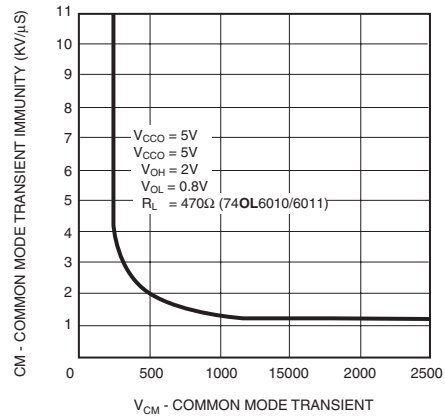

Figure 11. Supply Current vs. Supply Voltage

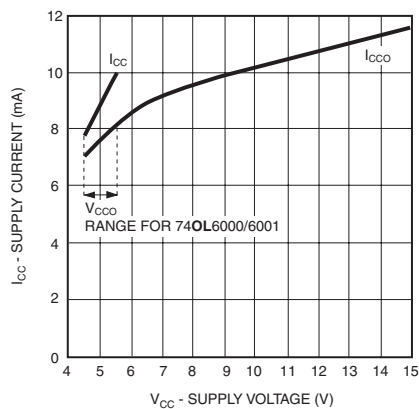
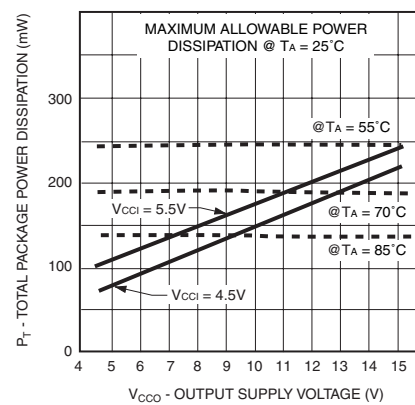

Figure 12. Power Dissipation vs. Ambient Temperature



LSTTL TO

TTL BUFFER	74OL6000
TTL INVERTER	74OL6001
CMOS BUFFER	74OL6010
CMOS INVERTER	74OL6011

Figure 13. Input Threshold Voltage vs. Ambient Temperature

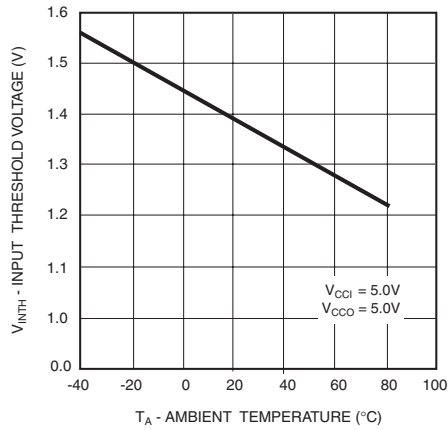

Figure 14. Input Current vs. Input Voltage

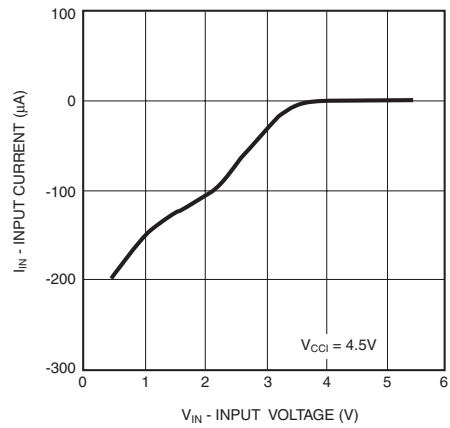

Figure 15. Switching Time Test Circuit

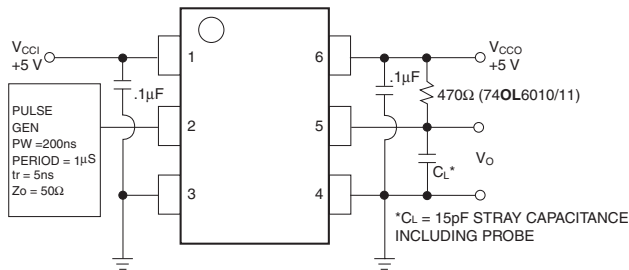
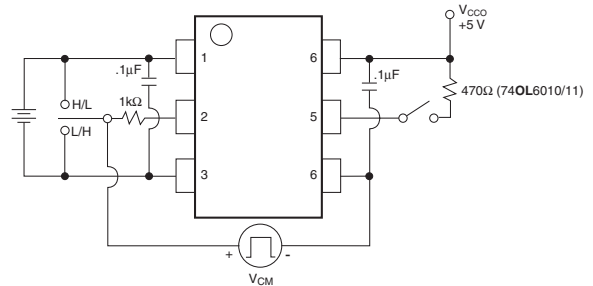

Figure 16. Common Mode Rejection Test Circuit



LSTTL TO

TTL BUFFER	74OL6000
TTL INVERTER	74OL6001
CMOS BUFFER	74OL6010
CMOS INVERTER	74OL6011

Figure 17. 74OL6000/01 Switching Times vs. Ambient Temperature

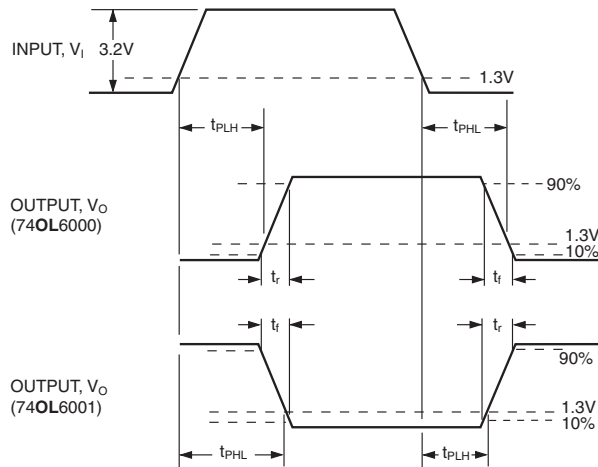

Figure 18. Switching Parameters 74OL6010/11

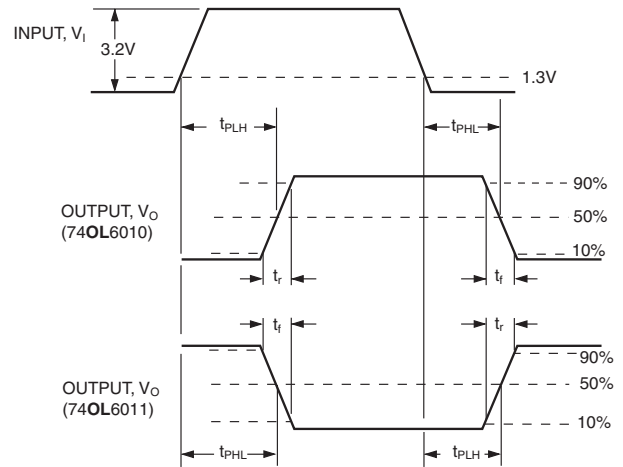

Figure 19. Common Mode Rejection Waveforms

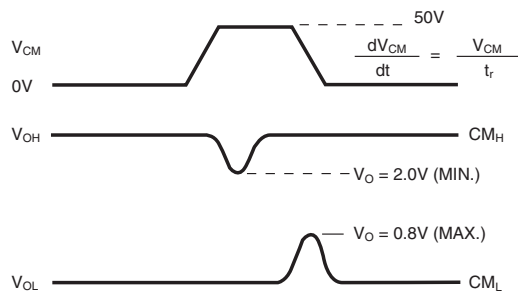
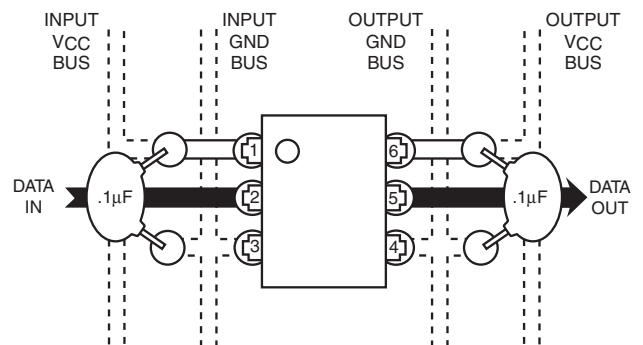

Figure 20. Suggested PCB Lay-Out



NOTE

1. The VCCO and VCCI supply voltages to the device must each be bypassed by a $0.1\mu F$ capacitor or larger. This can be either a ceramic or solid tantalum capacitor with good high frequency characteristics. Its purpose is to stabilize the operation of the high-gain amplifiers. Failure to provide the bypass will impair the DC and switching properties. The total lead length between capacitor and optocoupler should not exceed 1.5mm. See Fig. 20.
2. Device considered a two-terminal device. Pins 1, 2 and 3 shorted together, and Pins 4, 5 and 6 shorted together.
3. For example, assuming a V_{CCI} of 5.0V, and an ambient temperature of $70^\circ C$, the maximum allowable V_{CCO} is 12.1V.

LSTTL TO	TTL BUFFER	74OL6000
	TTL INVERTER	74OL6001
	CMOS BUFFER	74OL6010
	CMOS INVERTER	74OL6011

ORDERING INFORMATION

Option	Order Entry Identifier	Description
S	.S	Surface Mount Lead Bend
SD	.SD	Surface Mount; Tape and Reel
W	.W	0.4" Lead Spacing
300	.300	VDE 0884
300W	.300W	VDE 0884, 0.4" Lead Spacing
3S	.3S	VDE 0884, Surface Mount
3SD	.3SD	VDE 0884, Surface Mount, Tape and Reel

MARKING INFORMATION

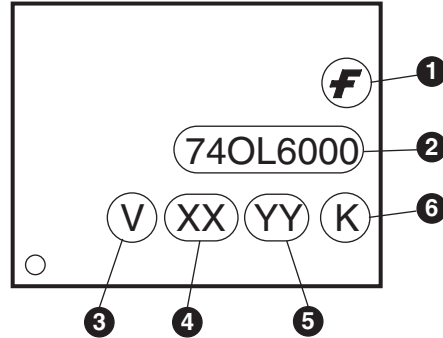

Definitions	
1	Fairchild logo
2	Device number
3	VDE mark (Note: Only appears on parts ordered with VDE option – See order entry table)
4	Two digit year code, e.g., '03'
5	Two digit work week ranging from '01' to '53'
6	Assembly package code

LSTTL TO

TTL BUFFER	74OL6000
TTL INVERTER	74OL6001
CMOS BUFFER	74OL6010
CMOS INVERTER	74OL6011

Reflow Profile (Black Package, No Suffix)

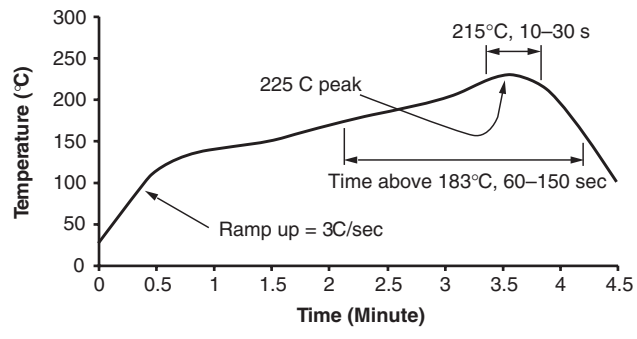

- Peak reflow temperature: 225°C (package surface temperature)
- Time of temperature higher than 183°C for 60–150 seconds
- One time soldering reflow is recommended

LSTTL TO

TTL BUFFER	74OL6000
TTL INVERTER	74OL6001
CMOS BUFFER	74OL6010
CMOS INVERTER	74OL6011

APPLICATION

Local area data communication systems can greatly improve their noise immunity by including OPOTOLOGIC gates in the design.

The Optologic input amplifier offers the feature of very high input impedance that permits their use as bridged line receivers. The system show above illustrates an optically isolated transmitter and multidrop receiver system. The network uses a 74OL6000 and buffer (Figure D) to isolate the transmitter and drive the 75Ω coax cable. This application uses a 1000 ft. aerial suspension 75Ω CATV coax cable with data taps at 250 ft. intervals. The 74OL6001s function as bridged receivers, and as many as 30 receivers could be placed along the line with minimal signal degradation. The communication cable is terminated with a single 75Ω load at the far end of the line.

Signal quality "Eye Pattern" is shown in Figures A, B and C with a 10MBaud NRZ Psuedo-Random Sequence (PRS). Traces 1-3 in Figure A describes the transmitter section. Traces 4-7 in Figure B show the output of the four Optologic bridged terminations. Traces 8-11 in Figure C illustrate "Eye Pattern" as seen at the output of a 74LS04 logic gate. The data quality is well preserved in that only a 30% Eye closure is seen at the receiver located 1000 ft. from the transmitter.

The data communication system is completely optically isolated from all of the terminal equipments. Power for the transmitter (V_{CCO}) and receiver (V_{CC}) is taken from an isolated power supply and distributed through a drain or messenger wire.

Figure A

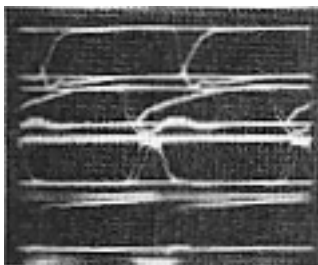

HORIZONTAL = 20 ns/DIV 42-11
VERTICAL = 2 V/DIV

Figure B

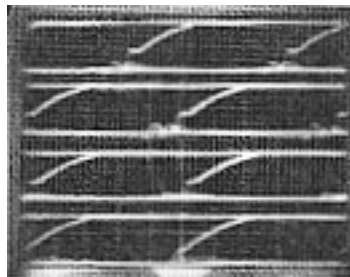

HORIZONTAL = 20 ns/DIV 42-12, 02
VERTICAL = 2 V/DIV

Figure C

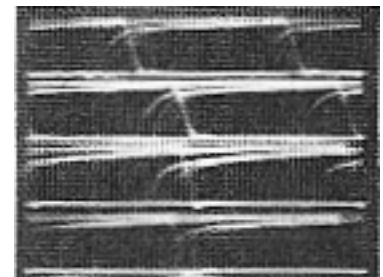

HORIZONTAL = 20 ns/DIV 42-13/03
VERTICAL = 2 V/DIV

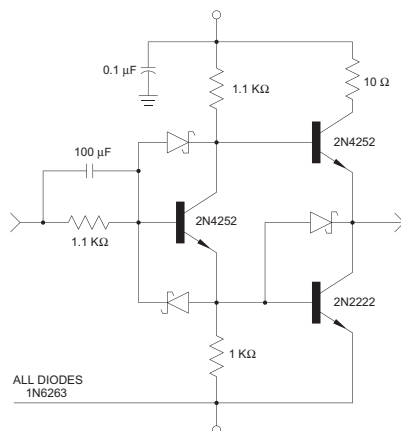
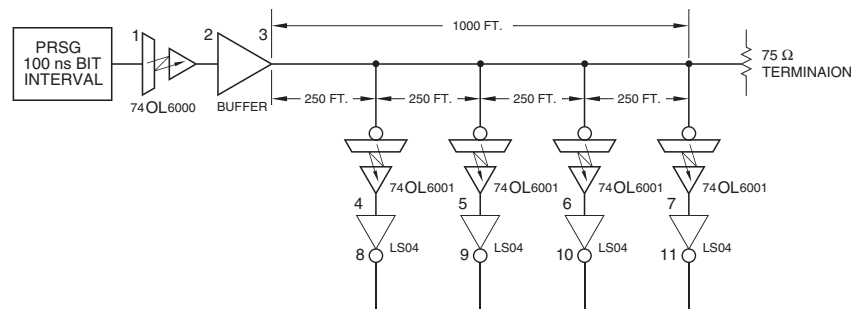

Figure D Buffer



LSTTL TO	TTL BUFFER	74OL6000
	TTL INVERTER	74OL6001
	CMOS BUFFER	74OL6010
	CMOS INVERTER	74OL6011

DISCLAIMER

FAIRCHILD SEMICONDUCTOR RESERVES THE RIGHT TO MAKE CHANGES WITHOUT FURTHER NOTICE TO ANY PRODUCTS HEREIN TO IMPROVE RELIABILITY, FUNCTION OR DESIGN. FAIRCHILD DOES NOT ASSUME ANY LIABILITY ARISING OUT OF THE APPLICATION OR USE OF ANY PRODUCT OR CIRCUIT DESCRIBED HEREIN; NEITHER DOES IT CONVEY ANY LICENSE UNDER ITS PATENT RIGHTS, NOR THE RIGHTS OF OTHERS.

LIFE SUPPORT POLICY

FAIRCHILD'S PRODUCTS ARE NOT AUTHORIZED FOR USE AS CRITICAL COMPONENTS IN LIFE SUPPORT DEVICES OR SYSTEMS WITHOUT THE EXPRESS WRITTEN APPROVAL OF THE PRESIDENT OF FAIRCHILD SEMICONDUCTOR CORPORATION. As used herein:

1. Life support devices or systems are devices or systems which, (a) are intended for surgical implant into the body, or (b) support or sustain life, and (c) whose failure to perform when properly used in accordance with instructions for use provided in the labeling, can be reasonably expected to result in a significant injury of the user.
2. A critical component in any component of a life support device or system whose failure to perform can be reasonably expected to cause the failure of the life support device or system, or to affect its safety or effectiveness.