

AS-i add-on module for safe switching-off Connection control circuit: screw terminal

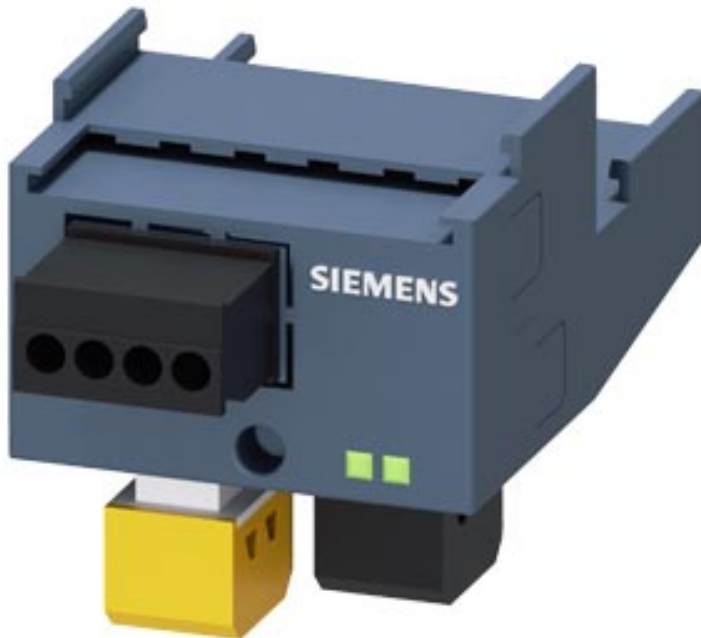











General technical data		
Product brand name		SIRIUS
Product designation		AS-i mounting module for safe shutdown
Protection class IP		IP20
Relative humidity during operation	%	10 ... 90
<b>Ambient temperature</b>		
• during transport	°C	-25 ... +70
• during storage	°C	-25 ... +80
• during operation	°C	-20 ... +60
Reference code acc. to DIN EN 61346-2		K
Reference code acc. to DIN 40719 extended according to IEC 204-2 acc. to IEC 750		K
Installation/ mounting/ dimensions		
Width	mm	45
Height	mm	50
Depth	mm	78
Connections/ Terminals		
Wire stripping length	mm	7

<b>Type of electrical connection</b>		screw-type terminals
• for auxiliary and control current circuit		
Tightening torque for auxiliary contacts with screw-type terminals	N·m	0.5 ... 0.6

## Certificates/ approvals

<b>Certificate of suitability</b>	IEC / EN 60947-6-2	
-----------------------------------	--------------------	--

General Product Approval		EMC	Declaration of Conformity	
 CSA	 UL		 RCM	 EG-Konf.
				<a href="#">Miscellaneous</a>

Shipping Approval					other
 ABS	 BUREAU VERITAS	 LRS	 PRS	 RMRS	 ASi

other
<a href="#">Confirmation</a>

## Further information

**Information- and Downloadcenter (Catalogs, Brochures,...)**

<https://www.siemens.com/ic10>

**Industry Mall (Online ordering system)**

<https://mall.industry.siemens.com/mall/en/en/Catalog/product?mlfb=3RA6970-3B>

**Cax online generator**

<http://support.automation.siemens.com/WW/CAXorder/default.aspx?lang=en&mlfb=3RA6970-3B>

**Service&Support (Manuals, Certificates, Characteristics, FAQs,...)**

<https://support.industry.siemens.com/cs/ww/en/ps/3RA6970-3B>

**Image database (product images, 2D dimension drawings, 3D models, device circuit diagrams, EPLAN macros, ...)**

[http://www.automation.siemens.com/bilddb/cax\\_de.aspx?mlfb=3RA6970-3B&lang=en](http://www.automation.siemens.com/bilddb/cax_de.aspx?mlfb=3RA6970-3B&lang=en)

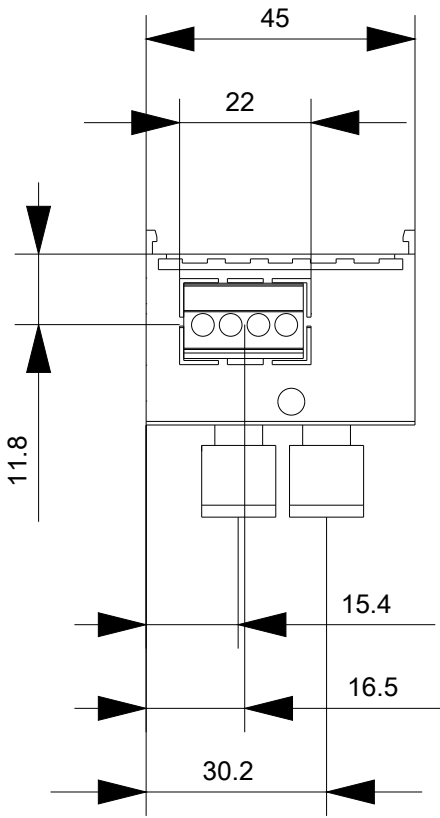

last modified:

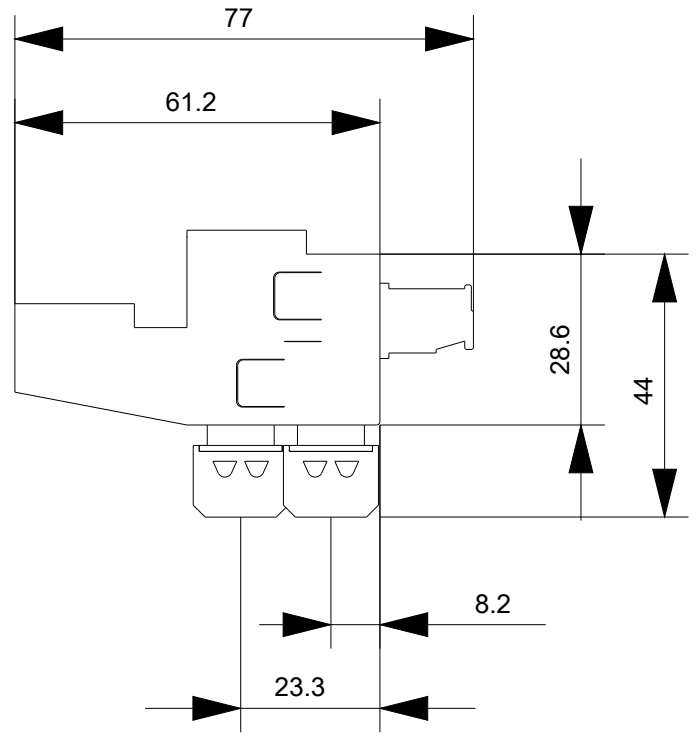

04/07/2020