

8	7	6	5
BASE PART NUMBER	THICKNESS	MATERIAL	STANDARD LENGTH PART NUMBER
0077-0018 (STANDARD)	0.089 ± 0.005 [0.0035]	BeCu ALLOY 25 TH01	0077001802
0078-0018 (ULTRASOFT)	0.051 ± 0.005 [0.0020]	BeCu ALLOY 25 TH01	0078001802

PLATING CODE TABLE	
NUMBER CODE	PLATING TYPE
02	BRIGHT FINISH
17	BRIGHT TIN
19	BRIGHT NICKEL
MORE PLATING OPTIONS AVAILABLE CONTACT LAIRD SALES FOR DETAILS	

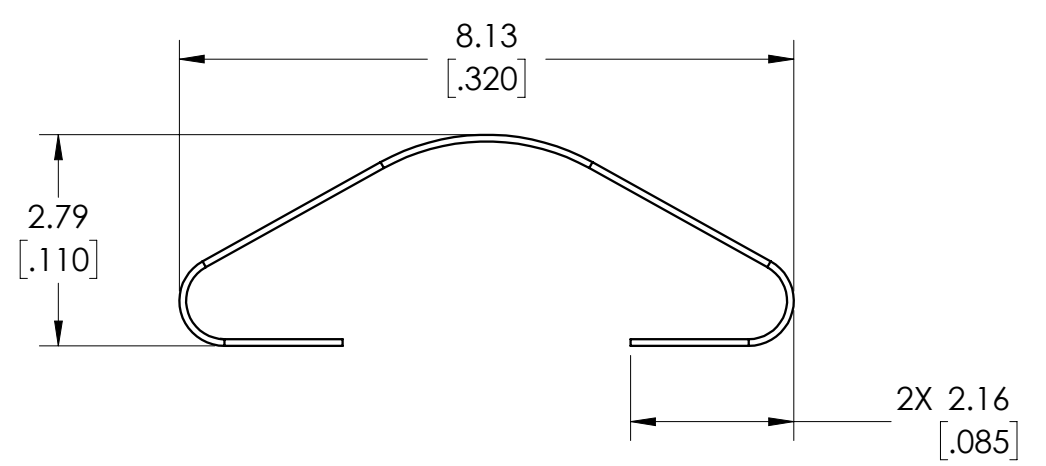
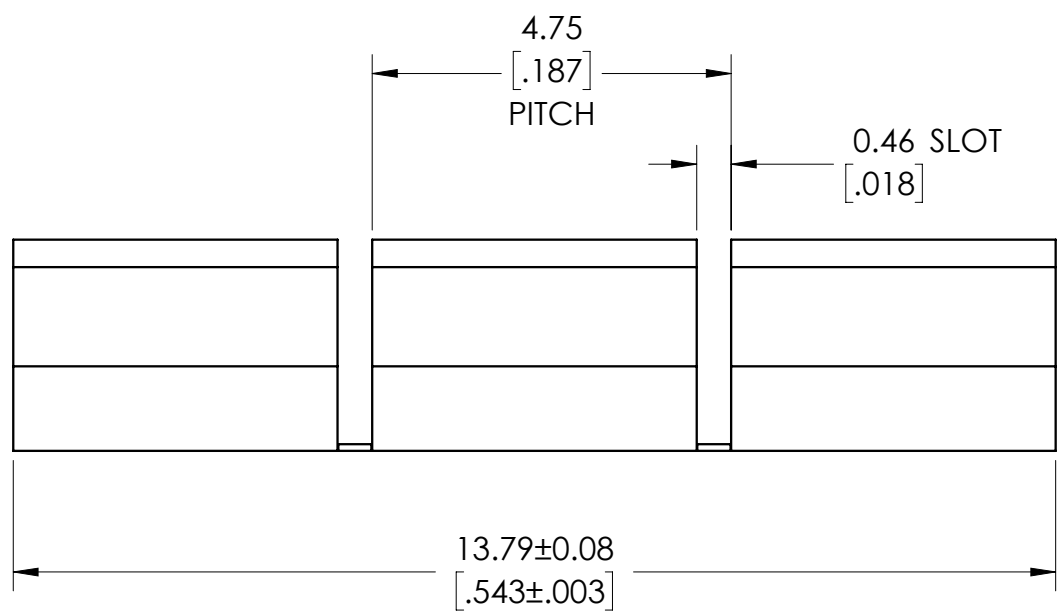

PART NUMBER CONFIGURATION:
007X 0018 XX

7 FOR STANDARD
8 FOR ULTRASOFT

PLATING CODE
(SEE TABLE)

EXAMPLE: 0078001817
ULTRASOFT, BRIGHT TIN PLATING

UNITS: MM [INCH]	Laird	LAIRD DRAWING NUMBER: 0077-0018-SALES
TOLERANCES: X.X = ± 0.4 X.XX = ± 0.2 X.XXX = ± 0.1		THIS IS AN UNCONTROLLED SALES DRAWING. THE DIMENSIONAL CHARACTERISTICS AND TOLERANCES OF THIS PART SHOWN ON THIS DRAWING AS A REFERENCE TO THE DIMENSIONAL SPECIFICATIONS OF THE LAIRD STANDARD PRODUCTION DRAWING FOR THIS PART. ANY SUBSEQUENT CHANGES TO THE STANDARD PART SPECIFICATION WILL SUPERSEDE THIS SALES DRAWING.
ANGULAR: X° = ± 3° X.X° = ± 1.0°	3RD ANGLE PROJECTION	DESIGNED IN SOLIDWORKS
	SCALE: 10:1	SHEET 1 OF 1
	SIZE B	