



OUR INNOVATION MOVES



# Duralon Composite Bearings Catalog

Imperial



Download the most up-to-date version  
at [rexnord.com/documentation](http://rexnord.com/documentation)

## Applications

**Duralon bearings can be used in a wide range of other applications that require:**

- Precision Tolerances
- Self-Lubricating to prevent build up of dirt, dust and paper collection
- Low wear rate for longer bearing life
- High Load and Shock resistance
- Reduced galling and scoring
- Corrosion resistance in wet environments
- Simple design
- Reduced weight
- Low sliding friction

## Construction Equipment

*Motor Grader Pivot Points*

Applications are in the hinge pins that connect the arms that raise & lower the scraper blade and the clevises used on the steering cylinders. Bearings are exposed to severe impact loads and dusty and dirty environments.



## Agriculture Equipment

*Cotton Harvester*

Self-lubricating bearings are used in the universal joint pivots. High load oscillating joint.



## Cylinders, Valves and Actuators

*Hydraulic & Pneumatic Cylinders*

Self-lubricating bearings provide long life without the need for external lubricants. Bearing precision maintains the rod location minimizing seal leakage. Cylinders can experience high side loads which react at the rod and the piston bearings. Self-lubricating bearings replace nodular iron, cast bronze, and other strip bearing materials.



## Recreational

### *Snowmobiles and ATV's*

Self-lubricating bearings can handle temperature variations from -65° up to +325° F. Self-lubricating bearings do not “gum up” from the belt dust. This is a high load application on continuously varying transmission weights, rollers, and linear sheave half bearings.



## Food

### *Packaging Machinery*

Self-lubricating bearings eliminate the need for maintenance and lubrication. Environmental exposure to mild alkalis, acid, brine solutions, and wash down fluids as well as low and high temperatures and dust are not a problem.

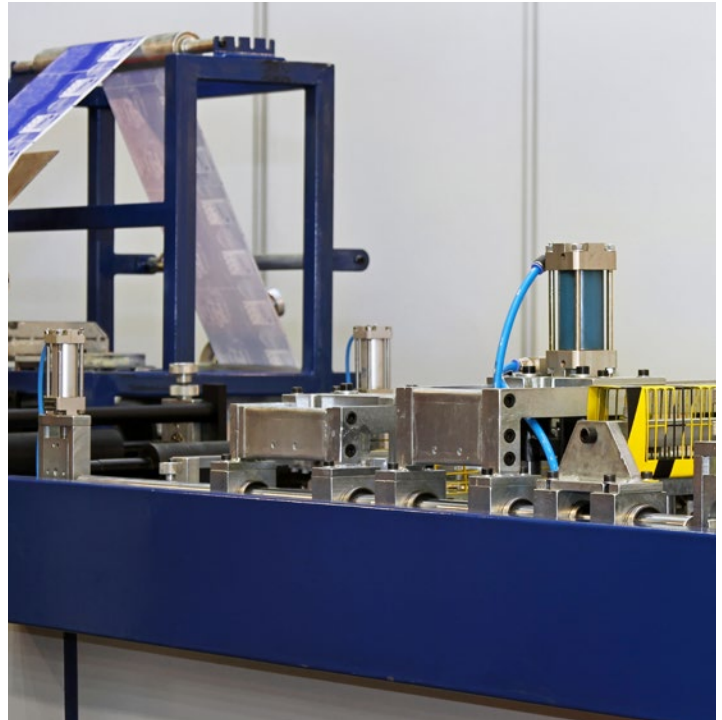

## Fresh & Saltwater

### *Self-Unloading Barges*

The dual-pivot cylinder mounting uses self-lubricating bearings, allowing the boom to swing and elevate a 250 foot long conveyor with a load capacity of 200 tons.

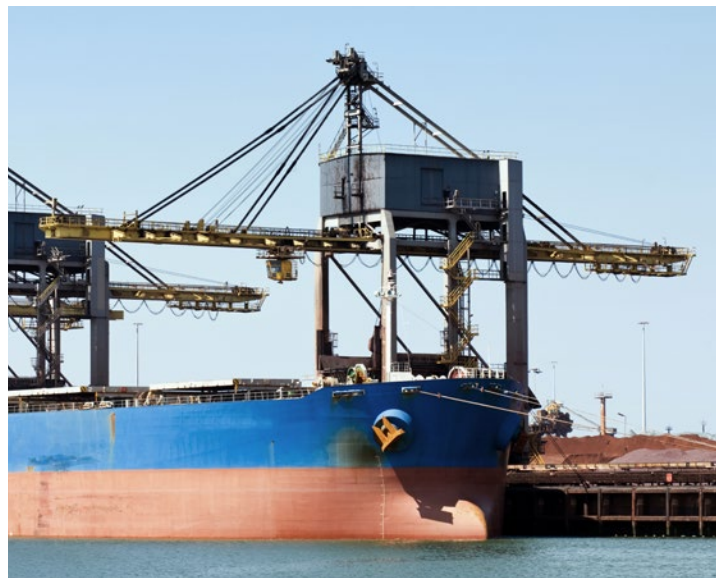



This Certificate of Registration acknowledges

## **Rexnord Industries, LLC Filament**

2324 Curtiss Street  
Downers Grove, Illinois 60515  
United States

is registered as a Single Site quality management system in conformance with

### **ISO 9001:2015 and AS9100D**

The audit was conducted in accordance with the requirements of SAE AS9104/1:2012-01. PRI Registrar<sup>SM</sup> is accredited under the ICOP Scheme.

### **Scope of Registration:**

Manufacture of Composite Bearings

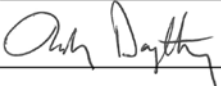

  
**Randy Daugharthy**  
Director of PRI Registrar

Number: 14207  
Issued: 07-Feb-2021  
Expires: 06-Feb-2024

## Table of Contents

<p><b>Applications ..... 2</b></p> <p>Construction Equipment ..... 2</p> <p>Agriculture Equipment ..... 2</p> <p>Cylinders, Valves and Actuators ..... 2</p> <p>Recreational ..... 3</p> <p>Food ..... 3</p> <p>Fresh &amp; Saltwater ..... 3</p> <p><b>ISO 9001 Certificate ..... 4</b></p> <p><b>General Description ..... 6</b></p> <p>Features and Benefits ..... 6</p> <p>Size and Shape Available ..... 6</p> <p><b>Material Properties ..... 7</b></p> <p>Thermal Properties ..... 7</p> <p>Electrical Properties ..... 7</p> <p>Chemical Properties ..... 7</p> <p><b>Design and Application Guidelines ..... 8</b></p> <p>Loads and ratings ..... 8</p> <p>Load-life relationship ..... 8</p> <p>Motion ..... 8</p> <p>Temperature ..... 8</p> <p>Full Rotation ..... 9</p> <p>Friction ..... 9</p> <p>Environmental ..... 9</p> <p><b>Duralon Bearing Selection ..... 10</b></p> <p>Life Calculation ..... 10</p> <p>Size Selection ..... 10</p> <p><b>Bearing Fatigue and Failure ..... 12</b></p> <p>Wear ..... 12</p> <p>Ultimate Strength ..... 12</p> <p>Fretting Corrosion ..... 12</p>	<p><b>Installation Practices &amp; Retention Methods</b></p> <p>Press Fit Retention and Shaft Running Clearances ... 13</p> <p>Machining dimensional Information ..... 13</p> <p>Other retention methods ..... 14</p> <p>General bonding recommendations ..... 14</p> <p>Shaft Recommendations ..... 15</p> <p><b>Machining Guidelines ..... 16</b></p> <p><b>Competitive Non-Lubricated Bearings ..... 17</b></p> <p><b>Appendix ..... 19</b></p> <p><b>Chemical Resistance of Duralon® Bearings ..... 20</b></p> <p><b>Duralon Product Nomenclature ..... 22</b></p> <p><b>Product Data Sheets ..... 23</b></p> <p>Thinwall Straight Sleeve Bearing ..... 23</p> <p>Thinwall Straight Sleeve Bearing (Metric) ..... 24</p> <p>Heavywall Straight Sleeve Bearing ..... 25</p> <p>Square Bore Bearings ..... 26</p> <p>Hex Bore Bearing ..... 27</p> <p>Linear Composite Bearings ..... 28</p> <p>Flange Bearings ..... 29</p> <p>Thrust Washers ..... 30</p> <p>Annular Bearings ..... 31</p> <p>Split Metallic Outer Race Annular Bearings ..... 32</p> <p>Actuator Nuts and Helical Bearings ..... 33</p> <p>Mounted Bearings ..... 34</p>
---	---

## General Description

Duralon bearings are a self-lubricated bearing, normally used between 4,000 and 30,000 psi in sliding and oscillating linkages. It is constructed from woven Teflon® high strength fiber and bondable yarns to make up the bearing element. Continuous strands of fiberglass and epoxy resin make up the matrix of the composite bearing material.

## Features and Benefits

Duralon Features	Duralon Benefits
Strength	Applications that have 30,000 psi dynamically Optimizes strength/weight ratio
Corrosion Resistance	Resists galvanic and fretting corrosion
Self-Lubricating	Eliminates contaminating lubricants Operates above or below useful temperature of lubricants Eliminates complex lubrication systems Minimizes slipstick problems
Seizure Resistance	Minimizes galling and scoring
Lightweight	77% of steel weight, 30% of aluminum – easier handling, reduces equipment weight
Non-Metallic	Electrical insulation Reduces noise volumes USDA approved for non-contact use

## Size and Shape Available

<b>Straight Sleeve Bearings</b>	Round, Square and Hex Bore Round Bore Diameter – 1/8" to 26" PTFE fabric on ID bore and optional on OD
<b>Linear Bearings</b>	Bore Diameter – 1/4" to 4" Available in open configuration to clear pedestal shaft mounts
<b>Flange Bearings</b>	Bore Diameter – 1/8" to 26" Available with or without woven PTFE liner on the flange face
<b>Thrust Washers</b>	Outer Diameter – 3/8" to 18"
<b>Spherical Annular</b>	Bore Diameter - 1/4" to 6"
<b>Acuator Bearing</b>	Bore Diameter – consult Rexnord Engineering Bore Shapes – Helical and threaded

## Material Properties

### Mechanical Properties

The mechanical properties of the filament wound back-up material are derived from the modulus of elasticity of the individual materials, and the construction. The values shown in Table 1 have been developed by using standard tests for cylindrical shapes.

	<b>Modulus (PSI)</b>	<b>Ultimate Strength (PSI)</b>
Axial Compression	.8x10 <sup>6</sup>	20,000
Hoop Tension	2.7x10 <sup>6</sup>	35,000
Bending	1.5x10 <sup>6</sup>	25,000
Torsion (45 degree helix angle)	1.5x10 <sup>6</sup>	27,000
Interlaminar Shear	N/A	3,000-5,000

Impact resistance (notch).....41 ft.lb./in.  
 Specific gravity .....1.9  
 Spring rate .....3.467x10<sup>6</sup> lb./in.  
 Ultimate strength (Sleeve Configuration) .....77,000 psi

NOTE: These values are applicable in -65 deg. to 250° F temperature range. Bearing wall thickness was .125" in these tests; varying that dimension and/or the helical winding angle will alter these values.

### Thermal Properties

Comparative values of the coefficient of expansion for the filament wound back-up material, aluminum and steel are given in table 2. The similarity between steel and filament wound back-up material in the hoop direction should be noted. A higher value for thermal expansion is realized in the axial direction because of the fiberglass filament orientation.

<b>Thermal Properties</b>	<b>Duralon Bearing filament wound material</b>	<b>Aluminum</b>	<b>Steel</b>
1. Expansion (IN/IN/°F)			
Axial Direction	15.0x10 <sup>-6</sup>	13.3x10 <sup>-6</sup>	6.0x10 <sup>-6</sup>
Hoop Direction	7.0x10 <sup>-6</sup>	13.3x10 <sup>-6</sup>	6.0x10 <sup>-6</sup>
2. Conductivity (BTU IN/FT 2°F Hr)	1.4	610-1100	95-185

### Electrical Properties

The filament wound back-up material is an electrical insulator. Its dielectric strength is about 300 volts per mil. Since the back-up material is electrically non-conducting, electrolytic or galvanic action will not take place between it and the housing or the shaft.

### Chemical Properties

While Duralon bearings are typically chemical resistant, however due to the wide range of exposures, specific conditions must be checked. See Appendix for listing. Consult Rexnord engineers at (800) 591-0886 or [www.rexnordcomposites.com](http://www.rexnordcomposites.com) with specific conditions and applications.



## Design and Application Guidelines

The overall performance of filament wound bearings is directly affected by operating factors such as applied loads, operating motions, duty cycle, environmental conditions, installation methods, shaft finish and hardness. While specific design criteria are not available for all applications, certain guidelines must be followed to provide the rated life.

### Loads and ratings

The filament wound back-up material in Duralon journal bearings is capable of withstanding static radial load levels as high as 60,000 psi on the projected bearing area. This is in excess of the fabric liner capability of (50,000 psi) based on previous experiences. The load deflection relationship of Duralon journal bearings and metal-backed Teflon lined bearings is very similar. The yield point and ultimate strength of the filament wound back-up material are approximately equal.

$$\text{PSI} = \frac{\text{Load lbs.}}{\text{I.D.} \times \text{W}}$$

### Load-life relationship

Since accumulated wear terminates the useful life of a properly selected Teflon liner bearing, the Duralon selection procedure is based on the use of Bearing Area Factors (BAF), rather than load ratings, to select a bearing which meets the combined load-life requirements of the application. The Bearing Area Factor (BAF) is a numerical index of a bearing's dynamic performance ability and is based upon effective bearing area.

Duralon bearings are rated on the basis of L10 life expectancy which means that 90% of a given group of bearings will exceed the predicted life. The correlation of load and life is shown in the lower half of the Selection Chart which relates the BAF to cycle of life. BAF values for bearings involving standard combinations of bore and length, are shown in the bearing listings.

Bearing Area Factor

$$\text{BAF} = \text{I.D.}^{.491} \times (\text{W} - .090)$$

$$\text{I.D.} = \text{Bearing Inner Diameter}$$

$$\text{W} = \text{Bearing Length}$$

All dimensions are in inches

### Motion

Duralon bearings can withstand various degrees of motion, depending upon speed and load. They will operate under all degrees of motion normally encountered in applications. Note that the degree of oscillation can affect bearing performance and must be taken into account when making a bearing selection, as shown on the nomograph.

Laboratory testing of Filament journal bearings has shown their capacity to operate successfully under the low speeds, (less than 90 cycles per minute), high load conditions, (up to 30,000 psi), as well as the high speeds, (up to 300 cpm), light load conditions (less than 5,000 psi)

### Temperature

The normal operating temperature range for Duralon bearings is -65° to 325° F. Satisfactory operation can be obtained with limited exposure to temperatures as high as 400° F. However, at continuous temperatures above 325° F an increase in wear rates will be experienced. Contact a Rexnord engineer for applications at cryogenic temperature, as well as for applications with continuous temperatures above 325° F. High temperature non-standard Duralon bearings are available.



## Full Rotation

Full rotation can be accommodated if load and speed are below the curve in the following graph. See reference formula for pressure and velocity.

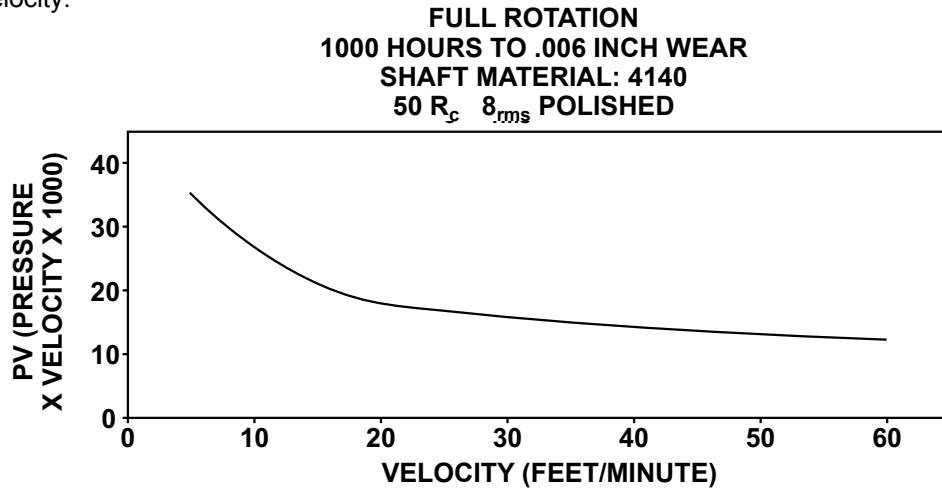

Formulae used in the selection of Duralon bearings.

Bearing Pressure

$$\text{PSI} = \frac{\text{Load lbs.}}{\text{I.D.} \times \text{W}}$$

Speed (Surface Velocity)

Full Rotation

$$\text{Surface velocity (Ft/Min)} = .262 \times \text{I.D.} \times \text{RPM}$$

\*All dimensions are in inches

## Friction

Duralon bearings offer low-friction operation. Friction coefficients vary from .21 to .05 depending on the load level. Increased loading results in significant decrease in coefficient of friction as shown below. Also as the bearing “breaks in” the coefficient of friction decreases.

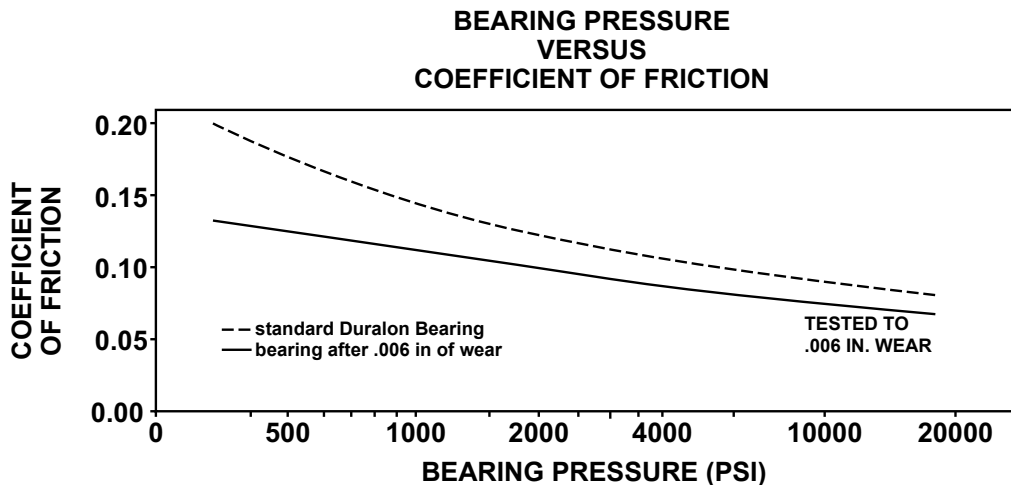

## Environmental

Duralon bearings are resistant to most environmental elements encounter in the bearing applications. Predictable wear lived have been obtained when bearings were operated in various fluids. However, specific test or evaluations is recommended.

## Duralon Bearing Selection

The Duralon selection graph is designed to handle general applications described by the following parameters:

Speed not exceeding 60 cycles per minute (12FPM)

Pressures not exceeding 25,000 psi

Oscillations 10° and greater, up to 90° included angle

For application requirements exceeding these parameters – consult a Rexnord engineer.

Duralon selection problems are typically either: (a) a life calculation where load and size are known or (b) a size selection, where load and required life are known.

Using the selection graph, and following the steps outlined can handle either situation:

### Life Calculation – (known load, oscillation and bearing size)

1. Convert oscillation angle to included angle, then follow that line horizontally until it intersects load level.
2. From that point, drop vertically down the chart until the BAF value is intersected. See section Design and Application Guidelines - Load-life relationship for complete explanation of BAF.
3. From that point, follow horizontally and read resulting cycles of life (to .006 wear).

### Size Selection – (known load, oscillation and required life)

1. Locate the intersection of the oscillation angle and load lines.
2. Drop vertically down the chart until the required life value is intersected.
3. Determine the required capacity BAF by following the inclined line from that point.
4. Select appropriate size bearing from the thin or heavy series with a BAF in excess of that value, incorporating any known size restrictions – and checking to assure that pin strength (bending) is adequate.

### Example – Life Calculation – See graph “RED LINES (Dashed)” for example on next page

Information required to use the selection chart is as follows:

Oscillation angle  $\pm 25$  degrees

Radial Load 15,000 lbs

Bearing size 1" dia,  $\frac{5}{8}$ " long

1. Included angle equals the plus and minus motion although the midpoint of the cycle  $\pm 25$  degrees equals an included angle of 50 degrees (point 1)
  - a. Radial load equals 15,000 lbs (point 2). These two intersect at (point 3).
2. The BAF for a 1" dia., with  $\frac{5}{8}$ " (.625) width bearing is .536, as found (point 4). This line intersects that (point 3) requirement at (point 5).
3. To determine life to .006 inch wear from chart read the vertical axis value (point 6), which equals 130,000 cycles.

### Example – Size Selection – See graph “BLUE LINES (Bolded)” for example on next page

Information to use chart is as follows:

Oscillation angle  $\pm 30$  degrees

Radial Load 20,000 lbs

Required life 500,000 cycles

Size restriction Cannot exceed 1  $\frac{1}{4}$ " dia pin

1. Included angle equals the plus and minus motion through the midpoint of the cycle, thus  $\pm 30$  degrees equals an included angle of 60 degrees (point 7) the radial load is 20,000 pounds (point 8), and the intersection of angle and load is (point 9).
2. Move down the chart vertically until the 500,000 cycle life (point 10) line is intersected - (point 11).
3. Follow the inclined line and read the required BAF value (point 12) or 1.5.
4. With a required BAF of 1.5, any bearing from the Product Data Sheets that exceeds the value could be selected ie. with a 1  $\frac{1}{4}$ " dia. pin, a 1  $\frac{1}{2}$ " length is required, thus a 701-00020-048. However, if a 1" dia. pin will accept the load, a longer 1  $\frac{3}{4}$ " length is required (701-00016-056). Checking of pin bending strength is appropriate.

EQUIVALENT RADIAL LOAD-POUNDS

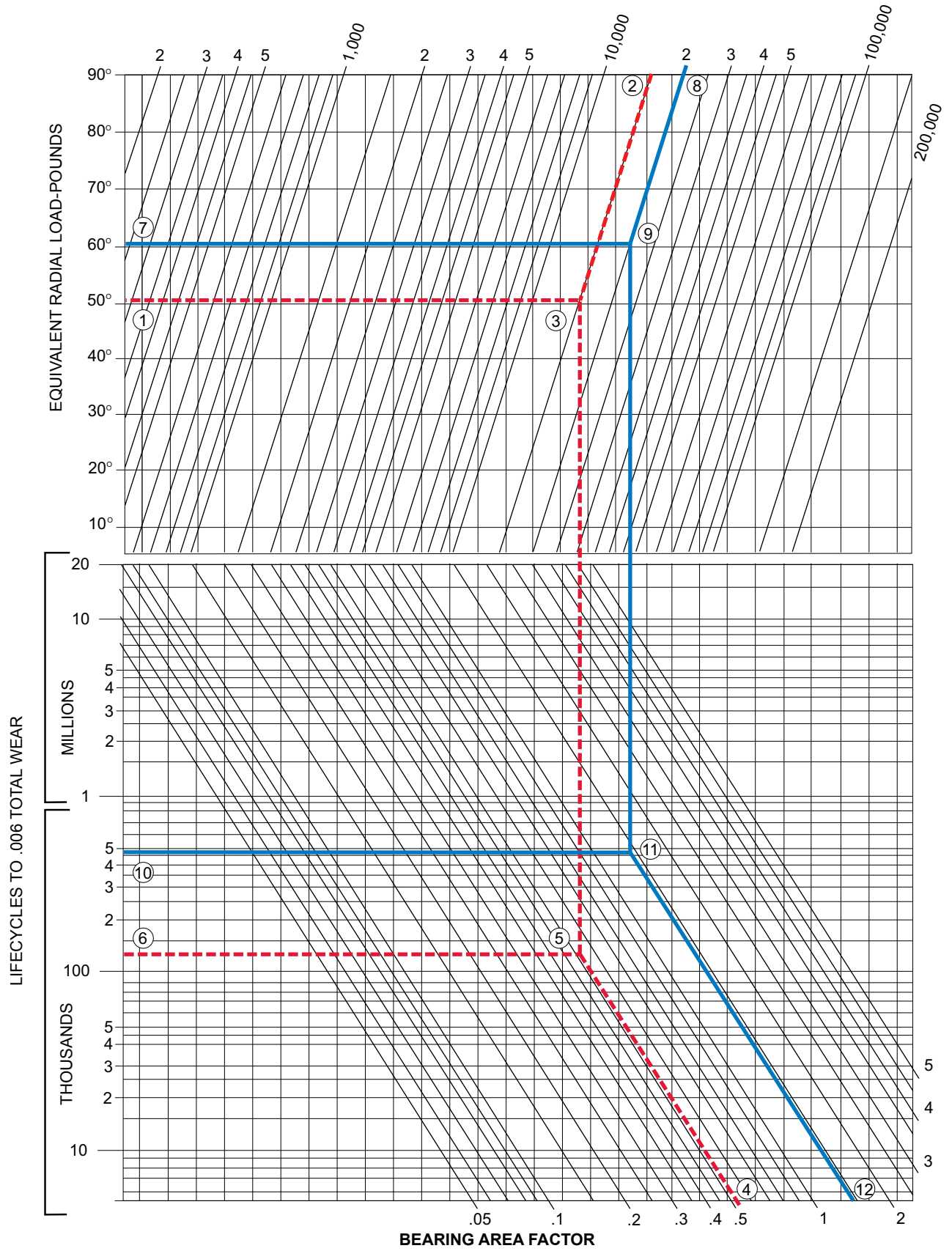

## Bearing Fatigue and Failure

### Wear

Bearing failure can be defined in various ways; however typically sliding type bearings relate it to a wearing away of the load carrying surface and resulting increase in clearance. Traditionally the industry value for evaluating wear life is .006. This is based on early work associated with TFE fabric liners; where the composition of the material changed as wear progressed. Significant changes in wear rate, torque, etc. occurred at about that point. However, since Duralon liner composition does not change, significant additional wear life is available beyond .006.

Bearing industry premise not only defines life (wear), but also typically assigns a probability or confidence level to those values. The traditional failure probability rating is 10%, known throughout the industry as an L-10 rating – meaning 10% will fall short of the value, but 90% will exceed it! An L-10 life rating is more conservative than the “average” (L-50) value.

### Ultimate Strength

All materials, metallic and non-metallic have varying capabilities to support applied load. In bearings, the basic materials, processing, and construction all contribute to the basic ability to support load – or the ultimate capacity of the bearing. In situations where loads exceed the ultimate strength of a bearing, the structure is fractured, resulting in rapid or even instantaneous failure. Since self-lubricating bearings cover a wide range of materials and constructions, some are not capable of withstanding loading above 1000 psi without experiencing ultimate load failures.

### Fretting Corrosion and Its Effect

When converting to a self-lubricating bearing, the external lubricant film is removed from the bearing loading zone. This allows contact between the bearing and the bearing to the shaft. This contact can cause fretting corrosion under the following conditions:

Motion	Examples
Small angles of oscillation	Toggle linkage
Small relative motion	Linear movement of a shaft in a shock absorber
Vibration	Torsional vibration from a diesel engine crank shaft or an unbalanced electric motor
Cyclic loading	Variable speed belt drive s

Metallic surfaces exposed to the above conditions start to fatigue. Particles break off and begin to oxidize resulting in fretting corrosion. It can occur at high or low loads. In ferrous metals this produces a residue of iron oxide, a reddish appearing dust commonly called jeweler’s rouge. These metallic particles are very abrasive and can cause wear of the shaft surface and bearing. The can occur even if the shaft surfaces are 50 Rc or harder.

Fretting Corrosion



### Fretting Corrosion Solutions

A hard, corrosion resistant wear surface will minimize fretting corrosion. Several processes have been used to eliminate fretting corrosion as follows:

1. Polished hard chrome plating .0005/.0010 inches thick.
2. Electroless nickel plating .0003 to .0005 inches thick.
3. Melonite QPQ heat treatment.

Other considerations are necessary when selecting the above process. Contact a Rexnord engineer for an in-depth analysis Melonite QPQ™ is a trademark of Houghton Durferrit GmbH, Germany.

## Installation Practices & Retention Methods

### Press Fit Retention and Shaft Running Clearances

The standard method of sleeve bearing retention is a “press” or interference fit. The dimensional listing for thin wall Duralon bearings provides recommended housing bores that develop a press fit range of .0002” to .0022” on diameter.

The press fit range for heavy wall Duralon bearings is larger. Refer to the dimensional listing for recommended housing bores. To avoid shearing the bearing OD, the press fit should not exceed .008”. The length/outside diameter ratio should not be greater than 2 to avoid buckling of the Duralon bearing.

If the application will see large temperature variations, the differences in the coefficients of expansion of the bearing and the housing must be considered when determining the amount of interference fit required, especially if the housing is aluminum.

When determining shaft running clearance, one must take into account that the bearing bore diameter will be reduced an amount equal to the press fit between the bearing and housing. In other words, if your bearing press fit is .002”, your bearing ID will be reduced .002”. Table 8 lists recommended minimum shaft running clearances for catalog bearings.

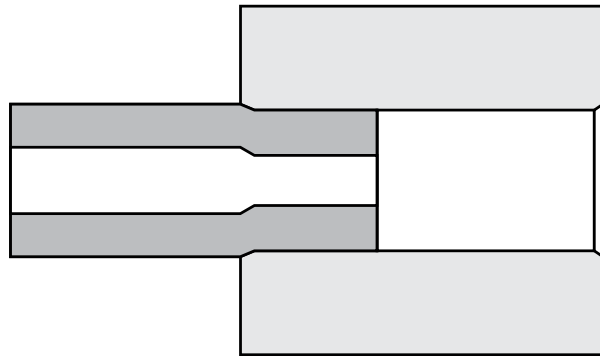

Recommended minimum shaft running clearances

Bore diameter (in.)	Minimum diametral clearance (in.)
Up to .999	0.0005
1.000 - 1.999	0.001
2.000 - 2.999	0.002
3.000 - 3.999	0.003
4.000 - 4.999	0.004
5.000 - 5.999	0.005
6.000 - 6.999	0.006
7.000 - 7.999	0.007
8.000 - 8.999	0.008
9.000 - 9.999	0.009
10	0.01

Consult a Rexnord engineer for special bearing retention or shaft clearance requirements.

## Other retention methods

Set Screws

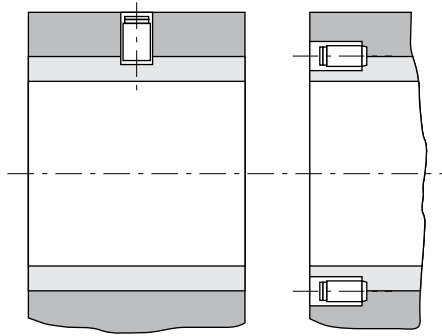

Normally used in steel housings this will allow torque transmission

Bonding

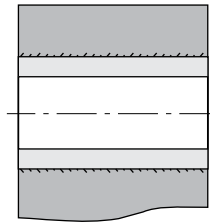

Several types of adhesives can be used

Snap Rings

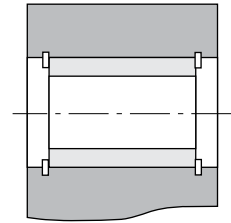

Used for linear travel on small diameter bearings

Bolts Thru Washer

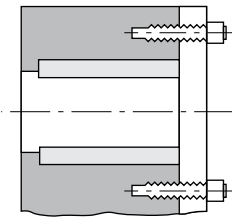

Easy assembly & disassembly  
Mostly found on linear motion large diameter gearings

Staking Ring

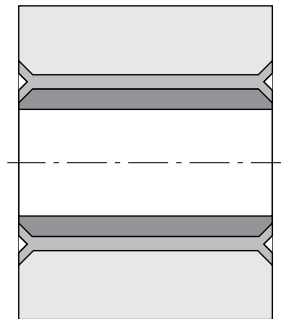

When either a spacer or the housing can be used to stake over the bearing O. D.

Dowel Pin

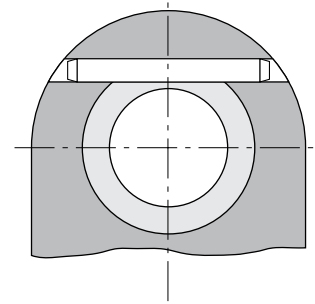

Stops motion in two directions

## General bonding recommendations

Another popular bearing retention method is bonding the bearing into the housing. This method reduces the effect of tolerance buildup in the bearing ID after assembly, minimizing shaft and bearing clearance range. This method also improves concentricity between multiple bearings on one or more shafts. Epoxies give the highest bond shear strength. Any 2-part epoxy that will bond fiberglass to metal will work.

The housing I.D. and bearing O.D. must be free of contaminants - water, oil, grease, dirt, etc. When bonding, do not allow the ambient temperature to drop below 50°F and do not accelerate the curing process by heating the assembly up. Heat may cause the viscosity of the epoxy resin to drop, allowing it to run to one side of the bearing. This will reduce the bond strength. For proper bond thickness, allow .005" to .010" diametral clearance between the bearing O.D. and the housing I.D. Shafting can be used to align multiple bearings on one shaft while the adhesive cures.

Any bearing retention grade cyanoacrylate compound can also be used to retain Duralon bearings. Cyanoacrylates are used to enhance a light press fit or retain the bearing with a pure bond. Consult the adhesive supplier for the best recommendation to bond fiberglass to metal. The bearing OD may need to be primed prior to application of the cyanoacrylate to activate the bearing surface. The same primer used to prepare aluminum surfaces will usually work with Duralon bearings.

## Shaft Recommendations

Since the shaft surface significantly affects the operation of the journal bearing design, its selection in regard to material, hardness, coating and surface roughness is crucial.

High loads require smooth surfaces with hardened and heat treated shafts. With stress levels of 8,000 to 30,000 psi shafting should have a surface finish of 8 micro inch or better to achieve optimum performance. However, tests have been run on 25-30 micro inch finishes with 55 Rc shafts at 4,000 psi with acceptable results.

### Shafting Materials

A number of shaft materials have been used in conjunction with Duralon bearings:

1. 52100 high carbon steel
2. 4140 chrome and nickel plated steel
3. 300 and 400 series stainless steel
4. Precipitation hardened grades 17-4PH, 15-5PH, 13-8PH Moly chrome and nickel plated stainless steel
5. 2000 and 7000 series aluminum grade hard anodized
6. Low to high carbon steels

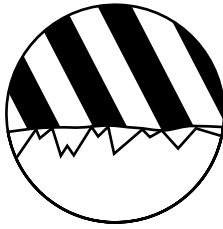

Sharp surface scratches

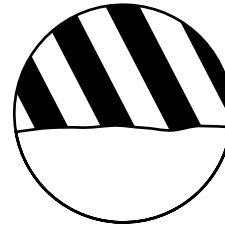

Smooth surface scratches

Surface roughness values do not define the character of the finish. Polished shafting (right) normally produces longer bearing life.



## Machining Guidelines

The following information should be used as a guide. As a general rule, the machining or cutting should be done wet to reduce dust. After any machining, wash the bearing to remove any abrasives from the bore.

### Turning

Use carbide or diamond tools.

If carbide is used:

- It should have at least a 10 deg. to 25 deg. side relief angle and the same end relief angle, grade CQ2 or equivalent.
- Feeds and speed at approximately the same rate as turning wood.

If diamond tools are used:

- Any good manufacturer diamond tool should be used. For example: Mega Diamond, GE Compacx, etc.
- Same speeds as carbide.

### Grinding

Silicon carbide grinding wheels work the best, but any grinding wheel will work for small quantities:

39 C 46 K8 VK - Norton

6 C 46 K6 VSC - Cincinnati

- Rough stock removal = up to .050 inch per pass.
- Finish stock removal = .004 to .010 inch per pass with one wiping pass.
- Part speed based on surface finish requirements. A good starting point is about 100 SFM.

### Facing or Grooving

Same tools as used in turning may be used.

### Cut-Off

Any reinforced cut-off wheel will cut fiberglass. Maximum wheel width should not exceed .125".

If non-reinforced wheels are used, an Everett #91, up to <sup>3</sup>/<sub>32</sub>" wide works well.

Plated diamond wheels also work very well using an 80/120 grit size.

### Deburring inside diameter

Placing a tightly fitting arbor on the bore of the bearing to support the inside diameter during the cutting will minimize peeling, fuzz and loose strings.

80 grit paper can be used to break the corners. Care should be taken not to roll the fabric back into the bore.

### Sizing of Bearing I.D

The bore of the Duralon bearing is not normally machined. If sizing is required after assembly, we recommend the removal of no more than .002" on diameter. The recommended method to size bearing bore is to use 200-400 grit wet/dry emery paper. If possible, size multiple bearings on the same shaft at the same time to maintain concentricity. It is important to wash out all abrasive particles from the bearing bore after sizing.

## Competitive Non-Lubricated Bearings

A vast number of metallic and non-metallic, lined and unlined sliding bearings are available. The various combinations of materials and construction, as well as performance characteristics and cost, can present quite a dilemma for the correct selection of a bearing.

Characteristics such as static capacity or ultimate strength must be considered from a structural standpoint and control some selections. Wear life or dynamic performance capabilities are the prime concern in others. Temperature limits may be a factor in regard to the liner or lubrication. There is a wide range of chemical capabilities, electrical conductivity, and other properties that can be the key in still other applications.

General grouping of friction bearings include: molded plastic materials, metallic bearings with liner strips, powdered metal with oil impregnation. Teflon lined with fiberglass backing and Teflon fabric lined with metal backing.

Within the group of fiberglass-backed bearings, those made from chopped fibers or braided filament has lower strength than those of filament-wound construction. Filament wound bearings rank high in static structural capacity and are also often tops in dynamic performance or wear-rate considerations.

Powdered metal bearings with oil impregnation – if re-lubricated, offer high dynamic ratings, but are subject to wear if the oil is lost. There are also high load and temperature limitations.

Metallic backed parts, with strip liners offer better wear life, but have only modest static capacity and temperature resistance. Molded plastic bearings can offer temperature advantages, but frequently have very low static capacity ratings.

Rexnord has tested a variety of bearings under two basic conditions: (1) high load/low speed, (2) low load/high speed. Table 9 reports the results of these tests.

### B10 Life in Cycles to .006" Wear

Bearing Type	Low Load Test	High Load Test
Duralon Bearing	25.2 x 10 <sup>6</sup>	1.00 x 10 <sup>6</sup>
Powder Bronze	70,000	0
Strip Overly (Teflon, Bronze, Steel Backed)Str	.58 x 10 <sup>6</sup>	14,000
Strip Overly (Tape, Steel Backed)	30,000	220
Fiberglass Backed (Nomex, Teflon)	.40 x 10 <sup>6</sup>	.20 x 10 <sup>6</sup>
Filament Wound Composite (woven PTFE)	3.72 x 10 <sup>6</sup>	1460
Filament Wound Composite (PTFE Fiber)	7.0 x 10 <sup>6</sup>	.36 x 10 <sup>6</sup>
Filament Wound Composite (Tape Liner)	1.0 x 10 <sup>6</sup>	12,000
Laminated Thermo Setting Resin (PTFE Fabric)	45,420	0
Laminated Phenolic	less than 7,000	0
Molded Compounded Teflon	0	0
Oil Filled Molded Plastic	58,000	0
Molybdenum Disulfide Filled Nylon	900	0

#### Test conditions

##### Low Load Test

Load: 4,000 psi    Speed: 168 CPM    Oscillations ±10°    (Travel .52 inches per cycle)

##### High Load Test

Load: 20,000 psi    Speed: 90 CPM    Oscillations ±25°    (Travel 1.3 inches per cycle)

All tests were conducted on 4140 steel pins with 50Rc hardness and a finish of 8 RMS polished or better. Test bearings were 1.50" I.D. x 0.5" wide.

## Competitive Non-Lubricated Bearings (cont.)

Machine Design – 1972-73 Bearing Reference Issue

Bearing Material	Load Capacity (psi)	Max Temp. (F)	Max Speed (fpm)	PV Limit Psi Load Time s Surface Fpm
Porous bronze	4,500	160	1,500	50,000
Porous iron	8,000	160	800	50,000
Phenolics	6,000	200	2,500	15,000
Nylon	1,000	200	1,000	3,000
TFE	500	500	50	1,000
Reinforced Teflon	2,500	500	1,000	10,000
<b>TFE fabric*</b>	<b>60,000</b>	<b>500</b>	<b>150</b>	<b>25,000</b>
Polycarbonate	1,000	220	1,000	3,000
Acetal	1,000	180	1,000	3,000
Carbon-graphite	600	750	2,500	15,000
Rubber	50	150	4,000	X
Wood	2,000	160	2,000	12,000

\*Show Duralon bearing classification. Not to be used for design purposes.

## Friction Properties

Bearing Material	Co-efficient	Slip Stick
Steel-on-Steel	0.50	Yes
Bronze-on-Steel	0.35	Yes
Aluminum Bronze-on-Steel	0.45	Yes
Sintered Bronze-on-Steel (mineral oil)	0.13	No
Bronze-on-Steel (mineral oil)	0.16	No
Copper Film Deposited on Steel	0.30	Yes
Lead Film Deposited on Copper-on-Steel	0.18	Yes
Copper Lead Alloy-on-Steel	0.22	Yes
Acetal-on-Steel	0.20	No
Nylon-on-Steel	0.32	Yes
UHMWP-on-Steel	0.20	Yes
Telfon-on-Steel	0.40	No
<b>Duralon-on-Steel</b>	<b>.05-.21</b>	<b>No</b>

## Appendix

### Reference Formula:

#### Bearing Area Factor

$$\text{BAF} = \text{I.D.}^{.491} \times (\text{W} - .090)$$

I.D. = Bearing Inner Diameter  
W = Bearing Length  
All dimensions are in inches

#### Bearing Pressure

$$\text{PSI} = \frac{\text{Load lbs.}}{\text{I.D.} \times \text{W}}$$

#### Oscillatory Motion

$$\text{Surface velocity (Ft/Min)} = \frac{\text{I.D.} \times 2 \times \text{included angle} \times \text{CPM}}{1.38 \times 10^3}$$

#### Bearing Weight (lbs)

$$.7854 \times (\text{O.D.}^2 - \text{I.D.}^2) \times \text{Length} \times .07$$

## Chemical Resistance of Duralon® Bearings

CHEMICAL	TEMP (°F)
Acetaldehyde	-
Acetic Acid 0 - 10%	150
Acetic Acid 10 - 50%	100
Acetic Acid Glacial	100
Acetone 0 - 5%	150
Acrylic Acid	-
Adipic Acid Solution	250
Alcohol Ethyl 10%	100
Alcohol Isopropyl 10%	100
Alcohol Methyl	100
Alcohol Methyl Isobutyl 10%	150
Alcohol Secondary Butyl 10%	150
Allyl Chloride	100
Aluminum Chloride	300
Aluminum Fluoride	150
Aluminum Hydroxide	150
Aluminum Nitrate	250
Aluminum Sulfate	300
Alums	300
Ammonia Gas - Dry	150
Ammonia - Wet	100
Ammonium Chloride	200
Ammonium Carbonate	200
Ammonium Fluoride 25%	150
Ammonium Hydroxide 0 - 10%	200
Ammonium Hydroxide 10 - 20%	150
Ammonium Hydroxide 20 - 30%	100
Ammonium Nitrate	250
Ammonium Persulfate	-
Ammonium Phosphate	150
Ammonium Sulfate	300
Amyl Acetate	75
Amyl Chloride	75
Aniline	75
Antimony Trichloride	150
Barium Carbonate	250
Barium Chloride	250
Barium Hydroxide 0 - 10%	200
Barium Sulphate	200
Barium Sulfide	300
Beer	200
Benzene	100
Benzene - 5% Kerosene	200
Benzene Sulfonic Acid	-
Benzoic Acid	200
Black Liquor	-
Borax	250
Boric Acid	200
Bromic Acid	150
Bromine - Liquid	-
Bromine Water	-
Butane	100
Butadiene	100
Butyl Acetate	75
Butyl Cellosolve	150
Butyric Acid 0 - 50%	150
Calcium Bisulfate	150
Calcium Carbonate	300
Calcium Chlorate	200
Calcium Chloride	300
Hydrobromic Acid 50%	150

CHEMICAL	TEMP (°F)
Calcium Hydroxide 0 - 50%	200
Calcium Hypochloride 0 - 20%	-
Calcium Nitrate	250
Calcium Sulfate	250
Carbon Dioxide	250
Carbon Bisulfate	-
Carbon Tetrachloride	100
Carbonic Acid	150
Castor Oil	200
Chloroacetic Acid 0 - 25%	100
Chlorine, Dry	-
Chlorine, Wet	-
Chlorine, Water	-
Chlorine Dioxide 15%	-
Chlorobenzene	100
Chloroform 100%	-
Chromic Acid 5 - 100%	-
Chromic Fluoride	75
Copper Chloride	250
Copper Fluoride	250
Copper Nitrate	250
Copper Sulfate	200
Crude Oil - Sour	300
Crude Oil - Sweet	300
Diacetone Alcohol	150
Dimethylamine	-
Dichlorobenzene 100%	100
Dichloroethylene	75
Diethylene Triamine 100%	-
Ethyl Cellusolve	100
Ethyl Ether	75
Ethyl Acetate	150
Ethyl Chloride	75
Ethylene Chlorohydrin	-
Ethylene Diamine	-
Ethylene Glycol	200
Ethylene Oxide	-
Fatty Acids	200
Ferric Chloride	300
Ferric Nitrate	250
Ferric Sulfate	-
Ferrous Chloride	250
Ferrous Sulfate	200
Fluorine Gas - Wet	-
Fluorosilicic Acid 10%	200
Fluoroboric Acid	-
Formaldehyde 40%	150
Formic Acid 25%	100
Freon	150
Gas - Natural	200
Gasoline - Sour	300
Gasoline, Refined, 108 Octane	150
Glucose	300
Glycerin	300
Glycol Ethylene	200
Glycol, Propylene	250
Heptane	150
Hexane	75
Hexylene Glycol Alcohol	150
Hydraulic Fluid	200
Propane	100

These results are based on testing of the fiberglass backing.  
This chart should only be used as a guide.

## Chemical Resistance of Duralon® Bearings

CHEMICAL	TEMP (°F)
Hydrochloric Acid 0 - 37%	200
Hydrochloric Acid 30% + Chlorine Gas 50%	-
Hydrocyanic Acid 10%	-
Hydrofluoric Acid	-
Hydrogen	150
Hydrogen Peroxide 10%	150
Hydrogen Peroxide 20%	75
Hydrogen Peroxide 30%	75
Hydrogen Sulfide - Dry	250
Hydrogen Sulfide - Aqueous	250
Hypochlorous Acid 10%	200
Jet Fuel	250
Kerosene	250
Lactic Acid	200
Lauric Acid	200
Lead Acetate	250
Levulinic Acid 25%	200
Magnesium Carbonate	250
Magnesium Chloride	300
Magnesium Hydrozide	250
Magnesium Nitrate	250
Magnesium Sulfate	300
Maleic Acid 100%	150
Mercury	300
Methyl Ethyl Ketone	75
Methyl Isobutyl Ketone	150
Methyl Isobutyl Carbitol	100
Mineral Oils	300
Naptha	200
Napthalene	150
Nickel Chloride	300
Nickel Nitrate	200
Nitric Acid 10%	-
Nitric Acid 15%	-
Nitric Acid 20%	-
Oleic Acid	200
Oxalic Acid	250
Perchloric Acid 10%	75
Phenol 1%	150
Phosphoric Acid 1 - 75%	250
Phosphoric Acid 75 - 100%	-
Phosphorous Pentoxide 0 - 54%	200
Picric Acid	75
Pickling Acid, Sulfuric & Hydrochloric	250
Plating Solutions	200
Potassium Bicarbonate	300
Potassium Bromide	200
Potassium Carbonate	250
Potassium Chloride	300
Potassium Dichromate	250
Potassium Hydroxide	200
Potassium Nitrate	300
Potassium Permanganate 10%	150
Potassium Permanganate 25%	150
Potassium Sulfate	150

CHEMICAL	TEMP (°F)
Silicic Acid	200
Silver Nitrate	250
Soap	250
Sodium Acetate	200
Sodium Bicarbonate	250
Sodium Bisulfate	250
Sodium Bromide	200
Sodium Carbonate	300
Sodium Chlorate	-
Sodium Chloride	300
Sodium Cyanide	250
Sodium Dichromate	250
Sodium Ferrocyanide	300
Sodium Fluoride	250
Sodium Hydroxide 0 - 50%	200
Sodium Hypochlorite 15%	-
Sodium Methoxide 40%	150
Sodium Nitrate	300
Sodium Peroxide	75
Sodium Phosphate	200
Sodium Silicate	150
Sodium Sulfate	300
Sodium Sulfite	200
Sodium Thiosulfate	150
Stannic Chloride	200
Stearic Acid	150
Sulfamic Acid 25%	200
Sulfite Liquors	-
Sulfur Dioxide - Wet & Dry	-
Sulfuric Acid 10%	250
Sulfuric Acid 25%	150
Sulfuric Acid 50%	100
Sulfuric Acid 80%	-
Sulfurous Acid 7%	200
Tannic Acid	200
Tartaric Acid	250
Tetraethyl Lead	100
Toluol 100%	150
Trichloroacetic Acid	-
Trichloroethylene	150
Triethylamine	75
Trisodium Phosphate	150
Tung Oil	200
Turpentine	75
Urea	150
Vinegar	150
Vinyl Acetate	150
Water, Deionized	300
Water, Distilled	300
Water, Fresh	300
Water, Salt	300
Water, Sea	300
Xylene	-
Zinc Chloride	250
Zinc Sulfate	250

- For chemicals not listed, 48-hour testing is recommended. Submerge a test bearing in the chemical for 48 hours and observe any changes. Most reactions will occur in the first 24 hours. Consult Rexnord Engineering with any questions.
- The effect of bacteria is unknown.
- ALKALINITY – Strong caustic solutions (NaOH – Sodium Hydroxide – 10%) at elevated temperatures will attack the polymers in the bearing. However, caustic solutions used in food processing wash downs will not, provided the shaft does not corrode.

# Duralon Product Nomenclature

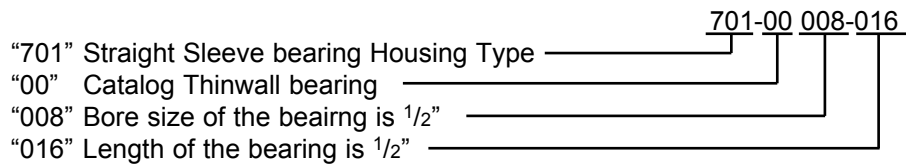
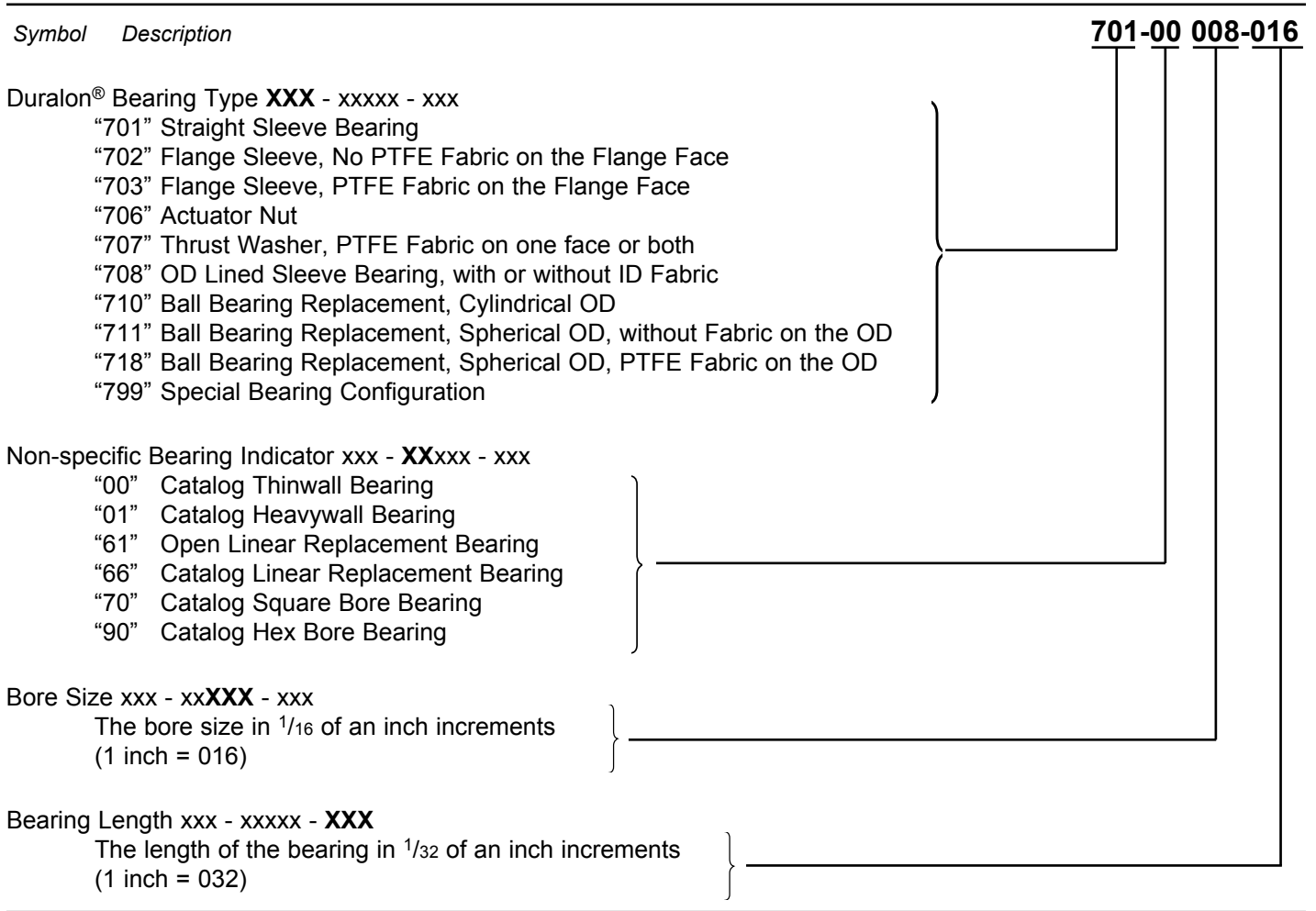



# Thinwall Straight Sleeve Bearing



## Features of Straight Sleeve Bearings

- Size:** Standard & Metric sizes - from .250" to 2.750" inside diameter
- Load:** Typical dynamic loads - 4,000 to 30,000 psi, Ultimate 77,000 psi
- Motion:** Oscillatory, pivot, linear sliding and slow speed full rotation
- Friction:** Coefficients vary from .16 @ 500 psi to .07 @ 20,000 psi
- Electrical:** Filament wound back-up material is an electrical insulator
- Chemical:** Resistant to most chemicals, see Appendix or consult Rexnord engineer
- Temperature:** -65°F to +325°F for Continuous, 400°F for Intermittent

The bearing consists of a self-lubricating woven Teflon fiber and polyester fiber liner supported by a filament wound continuous fiberglass fiber and epoxy resin matrix.

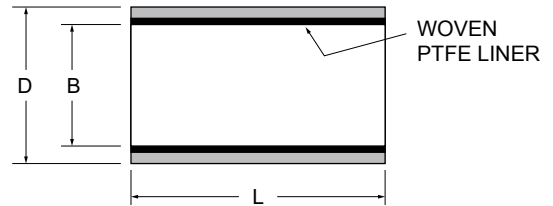

**BEARING MODEL NUMBER CALLOUT**

701-01XXX-XXX

BEARING TYPE CODE: STRAIGHT SLEEVE BEARING  
 CATALOG THIN WALL SERIES  
 BEARING BORE IN MULTIPLES OF 1/16"  
 BEARING LENGTH IN MULTIPLES OF 1/32"

Model Number	THINWALL					MODEL NUMBER SUFFIX													Maximum Length
	B	D	Hsg Bore	Max Shaft Dia	Wt (Ref)	L= Length Suffix in Multiples of 1/32" (Tolerance +.000/-.020)													
	±.0005	±.0005	±.0005		Lb/in.	0.250	0.375	0.500	0.625	0.750	0.875	1.000	1.125	1.250	1.375	1.500	1.750	2.000	
701-00004-XXX	0.2535	0.3762	0.3750	0.2500	0.0043	-008	-012	-016	-020	-024	-028	-032	-036	<b>-040</b>	<b>-044</b>	<b>-048</b>	<b>-056</b>	<b>-064</b>	3.000
701-00006-XXX	0.3785	0.5012	0.5000	0.3750	0.0060	-008	-012	-016	-020	-024	-028	-032	-036	<b>-040</b>	<b>-044</b>	<b>-048</b>	<b>-056</b>	<b>-064</b>	6.000
701-00008-XXX	0.5035	0.6262	0.6250	0.5000	0.0077	-008	-012	-016	-020	-024	-028	-032	-036	<b>-040</b>	<b>-044</b>	<b>-048</b>	<b>-056</b>	<b>-064</b>	6.000
701-00010-XXX	0.6285	0.7512	0.7500	0.6250	0.0094	<b>-008</b>	-012	-016	-020	-024	-028	-032	-036	-040	-044	<b>-048</b>	<b>-056</b>	<b>-064</b>	10.000
701-00012-XXX	0.7535	0.8762	0.8750	0.7500	0.0111	<b>-008</b>	-012	-016	-020	-024	-028	-032	-036	-040	-044	<b>-048</b>	<b>-056</b>	<b>-064</b>	10.000
701-00014-XXX	0.8785	1.0637	1.0625	0.8750	0.0199	<b>-008</b>	<b>-012</b>	-016	-020	-024	-028	-032	-036	-040	-044	-048	<b>-056</b>	<b>-064</b>	10.000
701-00016-XXX	1.0035	1.1887	1.1875	1.0000	0.0224	<b>-008</b>	<b>-012</b>	-016	-020	-024	-028	-032	-036	-040	-044	-048	-056	-064	10.000
701-00018-XXX	1.1285	1.3137	1.3125	1.1250	0.0250	<b>-008</b>	<b>-012</b>	<b>-016</b>	-020	-024	-028	-032	-036	-040	-044	-048	-056	-064	10.000
701-00020-XXX	1.2535	1.4387	1.4375	1.2500	0.0276	<b>-008</b>	<b>-012</b>	<b>-016</b>	-020	-024	-028	-032	-036	-040	-044	-048	-056	-064	10.000
701-00022-XXX	1.3785	1.5637	1.5625	1.3750	0.0301	<b>-008</b>	<b>-012</b>	<b>-016</b>	<b>-020</b>	-024	-028	-032	-036	-040	-044	-048	-056	-064	10.000
701-00024-XXX	1.5035	1.6887	1.6875	1.5000	0.0325	<b>-008</b>	<b>-012</b>	<b>-016</b>	<b>-020</b>	-024	-028	-032	-036	-040	-044	-048	-056	-064	10.000
701-00026-XXX	1.6285	1.8137	1.8125	1.6250	0.0352	<b>-008</b>	<b>-012</b>	<b>-016</b>	<b>-020</b>	<b>-024</b>	-028	-032	-036	-040	-044	-048	-056	-064	10.000
701-00028-XXX	1.7535	1.9387	1.9375	1.7500	0.0378	<b>-008</b>	<b>-012</b>	<b>-016</b>	<b>-020</b>	<b>-024</b>	<b>-028</b>	-032	-036	-040	-044	-048	-056	-064	10.000
701-00030-XXX	1.8785	2.0637	2.0625	1.8750	0.0404	<b>-008</b>	<b>-012</b>	<b>-016</b>	<b>-020</b>	<b>-024</b>	<b>-028</b>	-032	-036	-040	-044	-048	-056	-064	10.000
701-00032-XXX	2.0035	2.1887	2.1875	2.0000	0.0429	<b>-008</b>	<b>-012</b>	<b>-016</b>	<b>-020</b>	<b>-024</b>	<b>-028</b>	<b>-032</b>	-036	-040	-044	-048	-056	-064	10.000
701-00034-XXX	2.1285	2.3137	2.3125	2.1250	0.0455	<b>-008</b>	<b>-012</b>	<b>-016</b>	<b>-020</b>	<b>-024</b>	<b>-028</b>	<b>-032</b>	-036	-040	-044	-048	-056	-064	10.000
701-00036-XXX	2.2535	2.4387	2.4375	2.2500	0.0480	<b>-008</b>	<b>-012</b>	<b>-016</b>	<b>-020</b>	<b>-024</b>	<b>-028</b>	<b>-032</b>	-036	-040	-044	-048	-056	-064	10.000
701-00040-XXX	2.5035	2.6887	2.6875	2.5000	0.0532	<b>-008</b>	<b>-012</b>	<b>-016</b>	<b>-020</b>	<b>-024</b>	<b>-028</b>	<b>-032</b>	<b>-036</b>	-040	-044	-048	-056	-064	10.000
701-00044-XXX	2.7545	2.9487	2.9475	2.7500	0.0612	<b>-008</b>	<b>-012</b>	<b>-016</b>	<b>-020</b>	<b>-024</b>	<b>-028</b>	<b>-032</b>	<b>-036</b>	-040	-044	-048	-056	-064	10.000
						Standard MODEL SIZES are noted in <b>BLACK</b> , for MODEL SIZES in <b>RED (BOLD)</b> consult Rexnord Duralon Engineering													

# Thinwall Straight Sleeve Bearing (Metric)



## Features of Straight Sleeve Metric Bearing (Metric)

- Size:** Metric sizes - from 4mm to 660mm
- Load:** Typical dynamic loads - 4,000 to 30,000 psi, Ultimate 77,000 psi
- Motion:** Oscillatory, pivot, linear sliding and slow speed full rotation
- Friction:** Coefficients vary from .16 @ 500 psi to .07 @ 20,000 psi
- Electrical:** Filament wound back-up material is an electrical insulator
- Chemical:** Resistant to most chemicals, see Appendix or consult Rexnord engineer
- Temperature:** -65°F to +325°F for Continuous, 400°F for Intermittent

The bearing consists of a self-lubricating woven Teflon fiber and polyester fiber liner supported by a filament wound continuous fiberglass fiber and epoxy resin matrix.

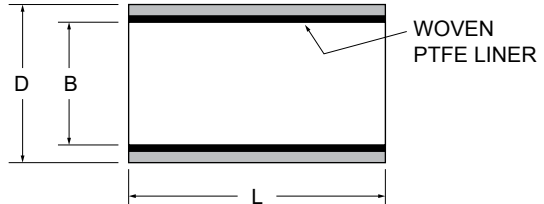

BEARING MODEL NUMBER CALLOUT

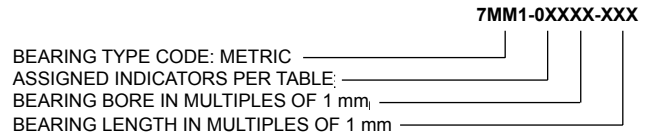

THINWALL - METRIC							MODEL NUMBER SUFFIX										
Model Number	B	Tolerance	D	Tolerance	Hsq Bore	Tolerance	Max Shaft Dia	L= Length Suffix in Multiples of 1mm (Tolerance +.000/- .500)									
								10	20	30	40	50	60	70	80	90	100
7MM1-02006-XXX	6,0855	±,0125	8,034	±,013	,8000	±,015	5,978	-010	-020	-030	-040	-050	-060	-070	<b>-080</b>	<b>-090</b>	<b>-100</b>
7MM1-03006-XXX	6,0855	±,0125	9,032	±,012	,9000		5,978	-010	-020	-030	-040	-050	-060	-070	<b>-080</b>	<b>-090</b>	<b>-100</b>
7MM1-02008-XXX	8,0900	±,0130	10,033	±,013	,10000		7,972	-010	-020	-030	-040	-050	-060	-070	-080	-090	-100
7MM1-03008-XXX	8,0900	±,0130	11,033	±,012	,11000		7,972	-010	-020	-030	-040	-050	-060	-070	-080	-090	-100
7MM1-02010-XXX	10,0890	±,0130	12,034	±,012	,12000	±,018	9,972	-010	-020	-030	-040	-050	-060	-070	-080	-090	-100
7MM1-03010-XXX	10,0890	±,0130	13,035	±,012	,13000		9,972	-010	-020	-030	-040	-050	-060	-070	-080	-090	-100
7MM1-02012-XXX	12,0880	±,0130	14,036	±,013	,14000		11,966	-010	-020	-030	-040	-050	-060	-070	-080	-090	-100
7MM1-03012-XXX	12,0880	±,0130	15,037	±,013	,15000		11,966	-010	-020	-030	-040	-050	-060	-070	-080	-090	-100
7MM1-02014-XXX	14,0895	±,0125	16,035	±,013	,16000	±,021	13,966	-010	-020	-030	-040	-050	-060	-070	-080	-090	-100
7MM1-03014-XXX	14,0895	±,0125	18,036	±,012	,18000		15,966	-010	-020	-030	-040	-050	-060	-070	-080	-090	-100
7MM1-02016-XXX	16,0885	±,0125	18,036	±,012	,18000		15,966	-010	-020	-030	-040	-050	-060	-070	-080	-090	-100
7MM1-03016-XXX	16,0885	±,0125	20,038	±,013	,20000		17,966	-010	-020	-030	-040	-050	-060	-070	-080	-090	-100
7MM1-02018-XXX	18,0900	±,0130	20,038	±,013	,20000	±,025	17,966	-010	-020	-030	-040	-050	-060	-070	-080	-090	-100
7MM1-03018-XXX	18,0900	±,0130	22,039	±,012	,22000		19,959	-010	-020	-030	-040	-050	-060	-070	-080	-090	-100
7MM1-02020-XXX	20,0890	±,0130	23,038	±,013	,23000		19,959	-010	-020	-030	-040	-050	-060	-070	-080	-090	-100
7MM1-03020-XXX	20,0890	±,0130	23,038	±,012	,24000		19,959	-010	-020	-030	-040	-050	-060	-070	-080	-090	-100
7MM1-02022-XXX	22,0880	±,0130	25,039	±,012	,25000	±,025	21,959	-010	-020	-030	-040	-050	-060	-070	-080	-090	-100
7MM1-03022-XXX	22,0880	±,0130	27,038	±,012	,27000		21,959	-010	-020	-030	-040	-050	-060	-070	-080	-090	-100
7MM1-02025-XXX	25,0875	±,0125	28,039	±,013	,28000		24,959	-010	-020	-030	-040	-050	-060	-070	-080	-090	-100
7MM1-03025-XXX	25,0875	±,0125	30,038	±,013	,30000		24,959	-010	-020	-030	-040	-050	-060	-070	-080	-090	-100
7MM1-02030-XXX	30,0890	±,0130	34,043	±,013	,34000	±,025	29,959	<b>-010</b>	-020	-030	-040	-050	-060	-070	-080	-090	-100
7MM1-03030-XXX	30,0890	±,0130	35,039	±,012	,35000		39,950	<b>-010</b>	-020	-030	-040	-050	-060	-070	-080	-090	-100
7MM1-02040-XXX	40,0890	±,0130	44,043	±,013	,44000		39,950	<b>-010</b>	-020	-030	-040	-050	-060	-070	-080	-090	-100
7MM1-03040-XXX	40,0890	±,0130	46,043	±,012	,46000		44,950	<b>-010</b>	<b>-020</b>	-030	-040	-050	-060	-070	-080	-090	-100
7MM1-02045-XXX	45,0875	±,0125	50,043	±,013	,50000	±,030	44,950	<b>-010</b>	<b>-020</b>	-030	-040	-050	-060	-070	-080	-090	-100
7MM1-03045-XXX	45,0875	±,0125	51,044	±,013	,51000		49,950	<b>-010</b>	<b>-020</b>	-030	-040	-050	-060	-070	-080	-090	-100
7MM1-02050-XXX	50,0890	±,0130	55,047	±,013	,55000		49,950	<b>-010</b>	<b>-020</b>	-030	-040	-050	-060	-070	-080	-090	-100
7MM1-03050-XXX	50,0890	±,0130	58,041	±,012	,58000		49,950	<b>-010</b>	<b>-020</b>	-030	-040	-050	-060	-070	-080	-090	-100

Standard MODEL SIZES are noted in **BLACK**, for MODEL SIZES in **RED (BOLD)** consult Rexnord Duralon Engineering

# Heavywall Straight Sleeve Bearing



## Features of Straight Sleeve Bearings

- Size:** Standard & Metric sizes - from 1.750" to 12.000" inside diameter
- Load:** Typical dynamic loads - 4,000 to 30,000 psi, Ultimate 77,000 psi
- Motion:** Oscillatory, pivot, linear sliding and slow speed full rotation
- Friction:** Coefficients vary from .16 @ 500 psi to .07 @ 20,000 psi
- Electrical:** Filament wound back-up material is an electrical insulator
- Chemical:** Resistant to most chemicals, see Appendix or consult Rexnord engineer
- Temperature:** -65°F to +325°F for Continuous, 400°F for Intermittent

The bearing consists of a self-lubricating woven Teflon fiber and polyester fiber liner supported by a filament wound continuous fiberglass fiber and epoxy resin matrix.

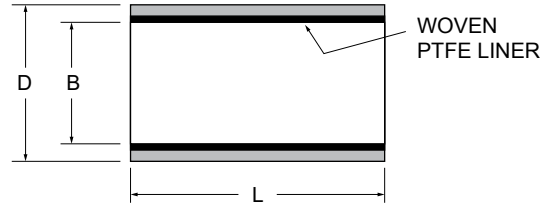

## BEARING MODEL NUMBER CALLOUT

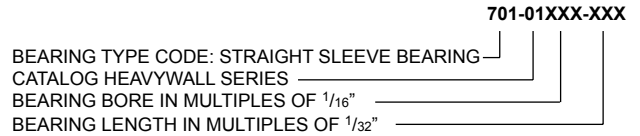

HEAVYWALL									MODEL NUMBER SUFFIX										
Model Number	B	Tolerance	D	Tolerance	Housing Bore	Tolerance	Max Shaft Dia	Wt (Ref) Lb/in.	L = Length Suffix in Multiples of 1/32" (Tolerance +.000/-.020)										
									1.000	1.125	1.250	1.375	1.500	1.750	2.000	3.500	4.000	6.000	10.000
701-01028-XXX	1.7590	±.0010	2.2505	±.0005	2.2470	±.001	1.7500	0.1086	-032	-040	-048	-056	-064	-080	-096	-112	-128	-192	-320
701-01032-XXX	2.0090		2.5005		2.4970		2.0000	0.1222	-032	-040	-048	-056	-064	-080	-096	-112	-128	-192	-320
701-01036-XXX	2.2590		2.7505		2.7470		2.2500	0.1357	-032	-040	-048	-056	-064	-080	-096	-112	-128	-192	-320
701-01040-XXX	2.5090		3.0005		2.9970		2.5000	0.1493	-032	-040	-048	-056	-064	-080	-096	-112	-128	-192	-320
701-01044-XXX	2.7590	+0.0013 -0.0012	3.2505	±.0005	3.2470	±.001	2.7500	0.1628	-032	-040	-048	-056	-064	-080	-096	-112	-128	-192	-320
701-01048-XXX	3.0097		3.5005		3.4970		3.0000	0.1762	-032	-040	-048	-056	-064	-080	-096	-112	-128	-192	-320
701-01052-XXX	3.2597		3.7505		3.7470		3.2500	0.1898	-032	-040	-048	-056	-064	-080	-096	-112	-128	-192	-320
701-01056-XXX	3.5097		4.0005		3.9970		3.5000	0.2033	-032	-040	-048	-056	-064	-080	-096	-112	-128	-192	-320
701-01060-XXX	3.7597	±.0015	4.2505	±.0005	4.2470	±.001	3.7500	0.2169	-032	040	-048	-056	-064	-080	-096	-112	-128	-192	-320
701-01064-XXX	4.0105		4.5005		4.4970		4.0000	0.2302	-032	040	-048	-056	-064	-080	-096	-112	-128	-192	-320
701-01068-XXX	4.2605		4.7505		4.7470		4.2500	0.2437	-032	-040	-048	-056	-064	-080	-096	-112	-128	-192	-320
701-01072-XXX	4.5125		5.0005		4.9970		4.5000	0.2562	-032	-040	-048	-056	-064	-080	-096	-112	-128	-192	-320
701-01076-XXX	4.7615	+0.0018 -0.0017	5.2505	±.0007 -.0008	5.2470	±.0015	4.7500	0.2702	-032	-040	-048	-056	-064	-080	-096	-112	-128	-192	-320
701-01080-XXX	5.0112		5.5005		5.4970		5.0000	0.2840	-032	-040	-048	-056	-064	-080	-096	-112	-128	-192	-320
701-01084-XXX	5.2612		5.7505		5.7470		5.2500	0.2975	-032	-040	-048	-056	-064	-080	-096	-112	-128	-192	-320
701-01088-XXX	5.5142		6.0008		5.9960		5.5000	0.3095	-032	-040	-048	-056	-064	-080	-096	-112	-128	-192	-320
701-01092-XXX	5.7642	±.0020	6.2508	±.0007 -.0008	6.2460	±.0015	5.7500	0.3230	-032	-040	-048	-056	-064	-080	-096	-112	-128	-192	-320
701-01096-XXX	6.0140		6.5008		6.4960		6.0000	0.3367	-032	-040	-048	-056	-064	-080	-096	-112	-128	-192	-320
701-01100-XXX	6.2640		6.7508		6.7460		6.2500	0.3502	-032	-040	-048	-056	-064	-080	-096	-112	-128	-192	-320
701-01104-XXX	6.5140		7.0008		6.9955		6.5000	0.3636	-032	-040	-048	-056	-064	-080	-096	-112	-128	-192	-320
701-01108-XXX	6.7640	+0.0023 -0.0022	7.2508	±.001	7.2455	±.0015	6.7500	0.3771	-032	-040	-048	-056	-064	-080	-096	-112	-128	-192	-320
701-01112-XXX	7.0137		7.5008		7.4955		7.0000	0.3910	-032	-040	-048	-056	-064	-080	-096	-112	-128	-192	-320
701-01120-XXX	7.5137		8.0008		7.9955		7.5000	0.4179	-032	-040	-048	-056	-064	-080	-096	-112	-128	-192	-320
701-01128-XXX	8.0135		8.2508		8.4955		8.0000	0.4453	-032	-040	-048	-056	-064	-080	-096	-112	-128	-192	-320
701-01136-XXX	8.5135	±.0025	9.0010	±.001	8.9955	±.0015	8.5000	0.4727	-032	-040	-048	-056	-064	-080	-096	-112	-128	-192	-320
701-01144-XXX	9.0135		9.5010		9.4955		9.0000	0.4997	-032	-040	-048	-056	-064	-080	-096	-112	-128	-192	-320
701-01152-XXX	9.5135		10.0010		9.9955		9.5000	0.5267	-032	-040	-048	-056	-064	-080	-096	-112	-128	-192	-320
701-01160-XXX	10.0135		10.5010		10.4955		10.0000	0.5537	-032	-040	-048	-056	-064	-080	-096	-112	-128	-192	-320
701-01168-XXX	10.5135	±.0025	11.0010	±.001	10.9955	±.0015	10.5000		-032	-040	-048	-056	-064	-080	-096	-112	-128	-192	-320
701-01176-XXX	11.0135		11.5010		11.4955		11.0000		-032	-040	-048	-056	-064	-080	-096	-112	-128	-192	-320
701-01184-XXX	11.5135		12.0010		11.9955		11.5000		-032	-040	-048	-056	-064	-080	-096	-112	-128	-192	-320
701-01192-XXX	12.0135		12.5010		12.4955		12.0000		-032	-040	-048	-056	-064	-080	-096	-112	-128	-192	-320
									Standard MODEL SIZES are noted in <b>BLACK</b> , for MODEL SIZES in <b>RED (BOLD)</b> consult Rexnord Duralon Engineering										

# Square Bore Bearings



## Features of Square Bore Duralon Bearings

- Size:** Standard sizes - from .250" to 1.500" inside diameter, larger sizes available
- Load:** Typical dynamic loads - 4,000 to 30,000 psi, Ultimate 77,000 psi
- Motion:** Linear sliding and/or torque transmission
- Friction:** Coefficients vary from .16 @ 500 psi to .07 @ 20,000 psi
- Electrical:** Filament wound back-up material is an electrical insulator
- Chemical:** Resistant to most chemicals, see Appendix or consult Rexnord engineer
- Temperature:** -65°F to +325°F for Continuous, 400°F for Intermittent

The bearing consists of a self-lubricating woven Teflon fiber and polyester fiber liner supported by a filament wound continuous fiberglass fiber and epoxy resin matrix.

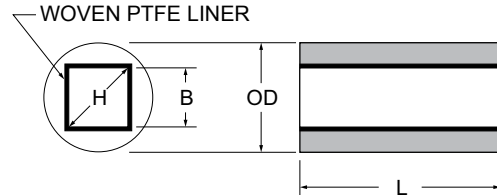

BEARING MODEL NUMBER CALLOUT



SQUARE BORE				MODEL NUMBER SUFFIX													MAXIMUM LENGTH
Model Number	B ±.001	D ±.0005	H Minimum	L= Length Suffix in Multiples of 1/32" (Tolerance +.000/-.020)													
				0.250	0.375	0.500	0.625	0.750	0.875	1.000	1.125	1.250	1.375	1.500	1.750	2.000	
701-70004-XXX	0.254	0.5012	0.313	-008	-012	-016	-020	-024	-028	-032	-036	<b>-040</b>	<b>-044</b>	<b>-048</b>	<b>-056</b>	<b>-064</b>	3.000
701-70006-XXX	0.379	0.7512	0.490	-008	-012	-016	-020	-024	-028	-032	-036	<b>-040</b>	<b>-044</b>	<b>-048</b>	<b>-056</b>	<b>-064</b>	6.000
701-70008-XXX	0.504	0.8762	0.667	-008	-012	-016	-020	-024	-028	-032	-036	<b>-040</b>	<b>-044</b>	<b>-048</b>	<b>-056</b>	<b>-064</b>	6.000
701-70010-XXX	0.629	1.0012	0.843	<b>-008</b>	-012	-016	-020	-024	-028	-032	-036	-040	-044	<b>-048</b>	<b>-056</b>	<b>-064</b>	10.000
701-70012-XXX	0.754	1.2512	1.020	<b>-008</b>	-012	-016	-020	-024	-028	-032	-036	-040	-044	<b>-048</b>	<b>-056</b>	<b>-064</b>	10.000
701-70014-XXX	0.879	1.5012	1.197	<b>-008</b>	<b>-012</b>	-016	-020	-024	-028	-032	-036	-040	-044	-048	<b>-056</b>	<b>-064</b>	10.000
701-70016-XXX	1.004	1.6262	1.374	<b>-008</b>	<b>-012</b>	-016	-020	-024	-028	-032	-036	-040	-044	-048	-056	-064	10.000
701-70018-XXX	1.129	1.8762	1.551	<b>-008</b>	<b>-012</b>	<b>-016</b>	-020	-024	-028	-032	-036	-040	-044	-048	-056	-064	10.000
701-70020-XXX	1.254	2.0012	1.727	<b>-008</b>	<b>-012</b>	<b>-016</b>	-020	-024	-028	-032	-036	-040	-044	-048	-056	-064	10.000
701-70022-XXX	1.379	2.2512	1.904	<b>-008</b>	<b>-012</b>	<b>-016</b>	<b>-020</b>	-024	-028	-032	-036	-040	-044	-048	-056	-064	10.000
701-70024-XXX	1.504	2.5012	2.081	<b>-008</b>	<b>-012</b>	<b>-016</b>	<b>-020</b>	-024	-028	-032	-036	-040	-044	-048	-056	-064	10.000

\* Standard MODEL SIZES are noted in **BLACK**,  
for MODEL SIZES in **RED (BOLD)** consult Rexnord Duralon Engineering

# Hex Bore Bearing



## Features of Hex Bore Duralon Bearings

- Size:** Standard sizes - from .250" to 1.500" inside diameter
- Load:** Typical dynamic loads - 4,000 to 30,000 psi, Ultimate 77,000 psi
- Motion:** Linear sliding and/or torque transmission
- Friction:** Coefficients vary from .16 @ 500 psi to .07 @ 20,000 psi
- Electrical:** Filament wound back-up material is an electrical insulator
- Chemical:** Resistant to most chemicals, see Appendix or consult Rexnord engineer
- Temperature:** -65°F to +325°F for Continuous, 400°F for Intermittent

The bearing consists of a self-lubricating woven Teflon fiber and polyester fiber liner supported by a filament wound continuous fiberglass fiber and epoxy resin matrix.

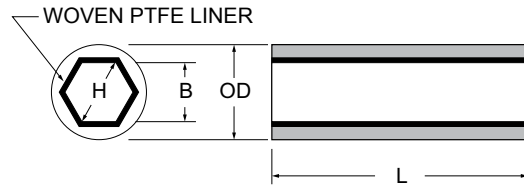

## BEARING MODEL NUMBER CALLOUT

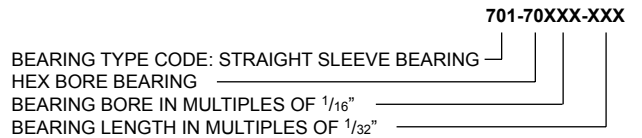

HEX BORE					MODEL NUMBER SUFFIX												MAXIMUM LENGTH	
Model Number	B	Tolerance	OD ± .0005	H Min.	L= Length Suffix in Multiples of 1/32" (Tolerance +.000/-.020)													
					0.250	0.375	0.500	0.625	0.750	0.875	1.000	1.125	1.250	1.375	1.500	1.750		2.000
701-90004-XXX	0.255	±.001	0.5012	0.248	-008	-012	-016	-020	-024	-028	-032	-036	<b>-040</b>	<b>-044</b>	<b>-048</b>	<b>-056</b>	<b>-064</b>	3.000
701-90006-XXX	0.380		0.6262	0.392	-008	-012	-016	-020	-024	-028	-032	-036	<b>-040</b>	<b>-044</b>	<b>-048</b>	<b>-056</b>	<b>-064</b>	6.000
701-90008-XXX	0.505		0.7512	0.537	-008	-012	-016	-020	-024	-028	-032	-036	<b>-040</b>	<b>-044</b>	<b>-048</b>	<b>-056</b>	<b>-064</b>	6.000
701-90010-XXX	0.630		0.8762	0.681	<b>-008</b>	-012	-016	-020	-024	-028	-032	-036	-040	-044	<b>-048</b>	<b>-056</b>	<b>-064</b>	10.000
701-90012-XXX	0.755		1.0012	0.825	<b>-008</b>	-012	-016	-020	-024	-028	-032	-036	-040	-044	<b>-048</b>	<b>-056</b>	<b>-064</b>	10.000
701-90014-XXX	0.880		1.2512	0.970	<b>-008</b>	<b>-012</b>	-016	-020	-024	-028	-032	-036	-040	-044	-048	<b>-056</b>	<b>-064</b>	10.000
701-90016-XXX	1.005		1.5004	1.114	<b>-008</b>	<b>-012</b>	-016	-020	-024	-028	-032	-036	-040	-044	-048	-056	-064	10.000
701-90018-XXX	1.130		1.6262	1.259	<b>-008</b>	<b>-012</b>	<b>-016</b>	-020	-024	-028	-032	-036	-040	-044	-048	-056	-064	10.000
701-90020-XXX	1.255		1.7512	1.403	<b>-008</b>	<b>-012</b>	<b>-016</b>	-020	-024	-028	-032	-036	-040	-044	-048	-056	-064	10.000
701-90022-XXX	1.380		1.8762	1.547	<b>-008</b>	<b>-012</b>	<b>-016</b>	<b>-020</b>	-024	-028	-032	-036	-040	-044	-048	-056	-064	10.000
701-90024-XXX	1.505	2.0012	1.692	<b>-008</b>	<b>-012</b>	<b>-016</b>	<b>-020</b>	-024	-028	-032	-036	-040	-044	-048	-056	-064	10.000	

\* Standard MODEL SIZES are noted in **BLACK**,  
 for MODEL SIZES in **RED (BOLD)** consult Rexnord Duralon Engineering

# Linear Composite Bearings



## Features of Linear Replacement Bearings

- Size:** Standard sizes - from .250" to 4.000" inside diameter
- Load:** Typical dynamic loads - 4,000 to 30,000 psi, Ultimate 77,000 psi
- Motion:** Oscillatory, pivot, linear sliding and slow speed full rotation
- Friction:** Coefficients vary from .16 @ 500 psi to .07 @ 20,000 psi
- Electrical:** Filament wound back-up material is an electrical insulator
- Chemical:** Resistant to most chemicals, see Appendix or consult Rexnord engineer
- Temperature:** -65°F to +325°F for Continuous, 400°F for Intermittent

### Applications using Duralon Linear Bearings:

- Feeding mechanisms                      Glass manufacturing equipment
- Packaging machinery                      Hydraulic and pneumatic cylinders
- Welding equipment                        Foundry machines
- Plastic molding machines                Office equipment
- Food Processing equipment - USDA APPROVED FOR NO CONTACT WITH FOOD

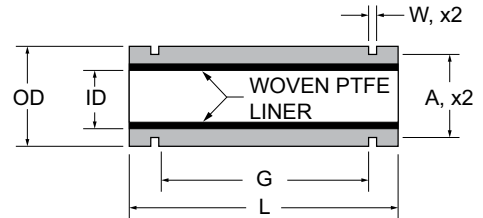

**BEARING MODEL NUMBER CALLOUT**

The bearing consists of a self-lubricating woven Teflon fiber and polyester fiber liner supported by a filament wound continuous fiberglass fiber and epoxy resin matrix. Open Linear bearings for pedestal shaft mounts available.

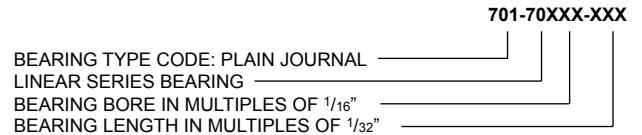

Model Number	I.D.	Tolerance	OD			L	G	Tolerance	Snap Ring Groove			O.D to I.D. Concentricity
			±.0005	±.010	G				W	Tolerance	A	
701-66004-024	0.2510	±.0005	0.5006	0.740	0.437	±.010	0.0405	±.0015	0.468	±.002	.001 TIR	
701-66006-028	0.3760		0.6256	0.865	0.562		0.0405		0.588	±.003		
701-66008-040	0.5010		0.8756	1.240	0.875		0.0475		0.821			
701-66010-048	0.6260		1.1256	1.490	1.000		0.0580	1.059	±.0020	±.004		
701-66012-052	0.7510		1.2506	1.615	1.062		0.0580	1.176				
701-66016-072	1.0010		1.5631	2.240	1.625		0.0700	1.468	±.0025	±.005		
701-66020-084	1.2510		2.0006	2.615	1.875		0.0700	1.886				
701-66024-096	1.5010		2.3756	2.990	2.250		0.0885	2.239				
701-66032-128	2.0010		3.0006	3.990	3.000		0.1055	2.838	±.0015	±.006		.003 TIR
701-60040-160	2.5055		3.7506	4.990	3.750		0.1225	3.493				
701-60048-192	3.0060	±.0010	4.5006	5.990	4.500	0.1225	4.190	±.0030	±.006			
701-60064-256	4.0065	±.0015	6.0006	7.990	6.000	±.020	0.1420			5.745		



# Flange Bearings



## Features of Flange Sleeve Bearings

- Size:** Standard sizes - from .250" to 2.500" inside diameter
- Load:** Typical dynamic loads - 4,000 to 30,000 psi, Ultimate 77,000 psi
- Motion:** Oscillatory, pivot, linear sliding and slow speed full rotation
- Friction:** Coefficients vary from .16 @ 500 psi to .07 @ 20,000 psi
- Electrical:** Filament wound back-up material is an electrical insulator
- Chemical:** Resistant to most chemicals, see Appendix or consult Rexnord engineer
- Temperature:** -65°F to +325°F for Continuous, 400°F for Intermittent - Style 702  
-65°F to +250°F for Continuous or Intermittent - Style 703

The bearing consists of a self-lubricating woven Teflon fiber and polyester fiber liner supported by a filament wound continuous fiberglass fiber and epoxy resin matrix.

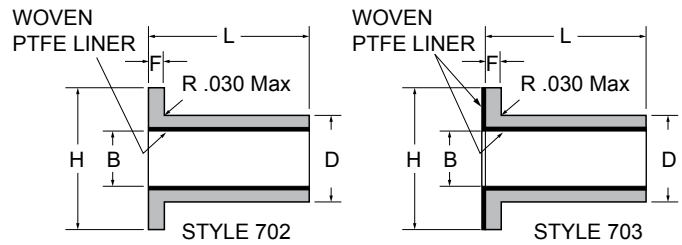

**BEARING MODEL NUMBER CALLOUT**

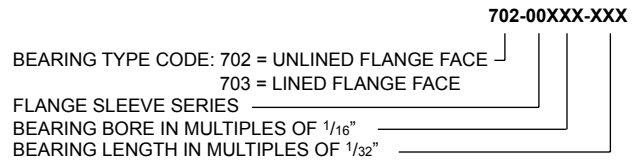

MODEL NUMBER		B ±.0005	D ±.0005	F ±.005	H ±.010	MODEL NUMBER SUFFIX												
UNLINED FACE	LINED FACE					L = Length Suffix in Multiples of 1/32" (Tolerance +.000/-0.020)												
						0.250	0.375	0.500	0.625	0.750	0.875	1.000	1.125	1.250	1.375	1.500	1.750	2.000
702-00004-XXX	703-00004-XXX	0.2535	0.3762	0.094	0.625	-008	-012	-016	-020	-024	-028	-032	-036	<b>-040</b>	<b>-044</b>	<b>-048</b>	<b>-056</b>	<b>-064</b>
702-00006-XXX	703-00006-XXX	0.3785	0.5012	0.125	0.750	-008	-012	-016	-020	-024	-028	-032	-036	<b>-040</b>	<b>-044</b>	<b>-048</b>	<b>-056</b>	<b>-064</b>
702-00008-XXX	703-00008-XXX	0.5035	0.6262	0.125	0.875	<b>-008</b>	<b>-012</b>	-016	-020	-024	-028	-032	-036	<b>-040</b>	<b>-044</b>	<b>-048</b>	<b>-056</b>	<b>-064</b>
702-00010-XXX	703-00010-XXX	0.6285	0.7512	0.125	1.000	<b>-008</b>	<b>-012</b>	-016	-020	-024	-028	-032	-036	-040	-044	<b>-048</b>	<b>-056</b>	<b>-064</b>
702-00012-XXX	703-00012-XXX	0.7535	0.8762	0.125	1.125	<b>-008</b>	<b>-012</b>	-016	-020	-024	-028	-032	-036	-040	-044	<b>-048</b>	<b>-056</b>	<b>-064</b>
702-00014-XXX	703-00014-XXX	0.8785	1.0637	0.125	1.312	<b>-008</b>	<b>-012</b>	-016	-020	-024	-028	-032	-036	-040	-044	-048	<b>-056</b>	<b>-064</b>
702-00016-XXX	703-00016-XXX	1.0035	1.1887	0.156	1.438	<b>-008</b>	<b>-012</b>	<b>-016</b>	-020	-024	-028	-032	-036	-040	-044	-048	-056	-064
702-00018-XXX	703-00018-XXX	1.1285	1.3137	0.156	1.562	<b>-008</b>	<b>-012</b>	<b>-016</b>	-020	-024	-028	-032	-036	-040	-044	-048	-056	-064
702-00020-XXX	703-00020-XXX	1.2535	1.4387	0.156	1.688	<b>-008</b>	<b>-012</b>	<b>-016</b>	<b>-020</b>	-024	-028	-032	-036	-040	-044	-048	-056	-064
702-00022-XXX	703-00022-XXX	1.3785	1.5637	0.156	1.812	<b>-008</b>	<b>-012</b>	<b>-016</b>	<b>-020</b>	-024	-028	-032	-036	-040	-044	-048	-056	-064
702-00024-XXX	703-00024-XXX	1.5035	1.6887	0.156	1.938	<b>-008</b>	<b>-012</b>	<b>-016</b>	<b>-020</b>	<b>-024</b>	-028	-032	-036	-040	-044	-048	-056	-064
702-00026-XXX	703-00026-XXX	1.6285	1.8137	0.156	2.062	<b>-008</b>	<b>-012</b>	<b>-016</b>	<b>-020</b>	<b>-024</b>	-028	-032	-036	-040	-044	-048	-056	-064
702-00028-XXX	703-00028-XXX	1.7535	1.9387	0.188	2.188	<b>-008</b>	<b>-012</b>	<b>-016</b>	<b>-020</b>	<b>-024</b>	<b>-028</b>	-032	-036	-040	-044	-048	-056	-064
702-00030-XXX	703-00030-XXX	1.8785	2.0637	0.188	2.312	<b>-008</b>	<b>-012</b>	<b>-016</b>	<b>-020</b>	<b>-024</b>	<b>-028</b>	-032	-036	-040	-044	-048	-056	-064
702-00032-XXX	703-00032-XXX	2.0035	2.1887	0.188	2.438	<b>-008</b>	<b>-012</b>	<b>-016</b>	<b>-020</b>	<b>-024</b>	<b>-028</b>	<b>-032</b>	-036	-040	-044	-048	-056	-064
702-00034-XXX	703-00034-XXX	2.1285	2.3137	0.188	2.562	<b>-008</b>	<b>-012</b>	<b>-016</b>	<b>-020</b>	<b>-024</b>	<b>-028</b>	<b>-032</b>	-036	-040	-044	-048	-056	-064
702-00036-XXX	703-00036-XXX	2.2535	2.4387	0.188	2.688	<b>-008</b>	<b>-012</b>	<b>-016</b>	<b>-020</b>	<b>-024</b>	<b>-028</b>	<b>-032</b>	<b>-036</b>	-040	-044	-048	-056	-064
702-00040-XXX	703-00040-XXX	2.5035	2.6887	0.188	2.938	<b>-008</b>	<b>-012</b>	<b>-016</b>	<b>-020</b>	<b>-024</b>	<b>-028</b>	<b>-032</b>	<b>-036</b>	-040	-044	-048	-056	-064

\* Standard MODEL SIZES are noted in **BLACK**, for MODEL SIZES in **RED (BOLD)** consult Rexnord Duralon Engineering



# Thrust Washers

## Features of Duralon Thrust Washers

- Size:** Standard sizes - from .250" to 2.000" inside diameter
- Load:** Typical dynamic loads - 4,000 to 20,000 psi, Ultimate 60,000 psi
- Motion:** Oscillatory and slow speed full rotation
- Friction:** Coefficients vary from .16 @ 500 psi to .07 @ 20,000 psi
- Electrical:** G-10 substrate material is an electrical insulator
- Chemical:** Resistant to most chemicals, see Appendix or consult Rexnord engineer
- Temperature:** Cryogenic to +250°F



The thrust washer is constructed by bonding woven Teflon® fiber fabric liner to one or both faces of a washer substrate. The substrate may be metallic, such as low carbon steel, stainless steel or aluminum. It may also be a non-metallic substrate such as NEMA grade G-10 or NEMA grade C. Standard washers are made with G-10 substrate.

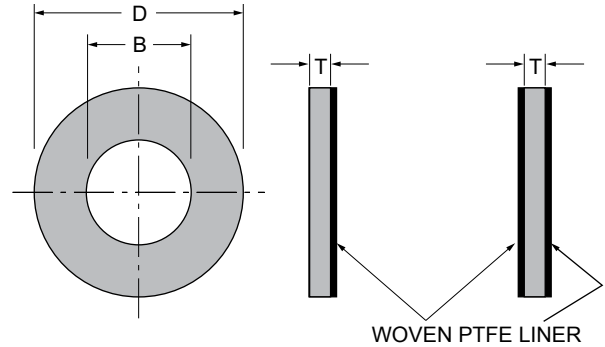

BEARING MODEL NUMBER CALLOUT

701-70XXX-XXX

BEARING TYPE CODE: THRUST WASHER  
 LINED FACE (00 = ONE FACE), (20 = BOTH FACES)  
 NOMINAL SHAFT DIAMETER IN MULTIPLES OF 1/16"  
 WASHER THICKNESS (002 = 1/16", 004 = 1/8")

Nominal Shaft Diameter	MODEL NUMBER - 1/16" Thickness		B + .020 - .000	D + .000 - .020	T ± .005
	LINED ONE FACE	LINED BOTH FACES			
0.250	707-00008-002	707-20008-002	0.270	0.500	0.062
0.312	707-00010-002	707-20010-002	0.332	0.625	0.062
0.375	707-00012-002	707-20012-002	0.395	0.750	0.062
0.437	707-00014-002	707-20014-002	0.457	0.875	0.062
0.500	707-00016-002	707-20016-002	0.520	1.000	0.062
0.625	707-00020-002	707-20020-002	0.645	1.250	0.062
0.750	707-00024-002	707-20024-002	0.770	1.500	0.062
0.875	707-00028-002	707-20028-002	0.895	1.750	0.062
1.000	707-00032-002	707-20032-002	1.020	2.000	0.062
1.125	707-00034-002	707-20034-002	1.145	2.125	0.062
1.250	707-00036-002	707-20036-002	1.270	2.250	0.062
1.375	707-00040-002	707-20040-002	1.395	2.500	0.062
1.500	707-00042-002	707-20042-002	1.520	2.625	0.062
1.625	707-00044-002	707-20044-002	1.645	2.750	0.062
1.750	707-00046-002	707-20046-002	1.770	2.875	0.062
1.875	707-00048-002	707-20048-002	1.895	3.000	0.062
2.000	707-00052-002	707-20052-002	2.020	3.250	0.062

Nominal Shaft Diameter	MODEL NUMBER - 1/8" Thickness		B + .020 - .000	D + .000 - .020	T ± .005
	LINED ONE FACE	LINED BOTH FACES			
0.250	707-00008-004	707-20008-004	0.270	0.500	0.125
0.312	707-00010-004	707-20010-004	0.332	0.625	0.125
0.375	707-00012-004	707-20012-004	0.395	0.750	0.125
0.437	707-00014-004	707-20014-004	0.457	0.875	0.125
0.500	707-00016-004	707-20016-004	0.520	1.000	0.125
0.625	707-00020-004	707-20020-004	0.645	1.250	0.125
0.750	707-00024-004	707-20024-004	0.770	1.500	0.125
0.875	707-00028-004	707-20028-004	0.895	1.750	0.125
1.000	707-00032-004	707-20032-004	1.020	2.000	0.125
1.125	707-00034-004	707-20034-004	1.145	2.125	0.125
1.250	707-00036-004	707-20036-004	1.270	2.250	0.125
1.375	707-00040-004	707-20040-004	1.395	2.500	0.125
1.500	707-00042-004	707-20042-004	1.520	2.625	0.125
1.625	707-00044-004	707-20044-004	1.645	2.750	0.125
1.750	707-00046-004	707-20046-004	1.770	2.875	0.125
1.875	707-00048-004	707-20048-004	1.895	3.000	0.125
2.000	707-00052-004	707-20052-004	2.020	3.250	0.125

# Annular Bearings



## Features of Duralon Annular Bearings

- Size:** Standard sizes - from .250" (821 Series) to 6.000" (801 Series) inside diameter
- Load:** Typical dynamic loads - 4,000 to 20,000 psi
- Motion:** Oscillatory, pivot, slow speed full rotation, for linear consult Rexnord engineer
- Friction:** Coefficients vary from .16 @ 500 psi to .07 @ 20,000 psi
- Electrical:** The composite component filament wound back-up material is an electrical insulator
- Chemical:** Resistant to most chemicals, consult Rexnord engineer
- Temperature:** -65°F to +325°F for Continuous, 400°F for Intermittent

The self-lubricating bearing element consist of a woven Teflon fiber and polyester fiber liner supported by a filament wound continuous fiberglass fiber and epoxy resin matrix. The mating element (wear surface) is metallic.

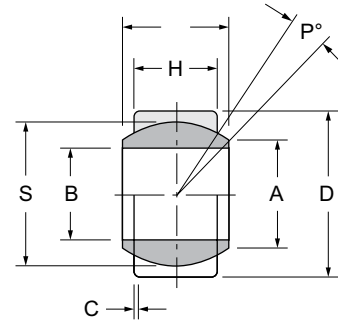

**PART NUMBER DESCRIPTION**  
**801 - Composite Outer Race with a Metallic Ball**  
**821 - Metallic Loader Slot Outer Race with a Composite Ball with Lined O.D.**

Model Number	B +.000 -.001	D +.001 -.000	W +.000 -.005	H +.000 -.005	A (Ref)	C +.010 -.010	P Deg. Max	S Ball O.D.	Limit Load Rating-Lbs.
801-08-14-01	0.500	0.8750	0.437	0.375	0.571	0.015	6	0.71 9	5,400
801-12-20-01	0.750	1.2500	0.656	0.562	0.858	0.015	6	1.080	12,140
801-14-23-01	0.875	1.4375	0.765	0.656	0.999	0.015	6	1.258	16,500
801-16-26-01	1.000	1.6250	0.875	0.750	1.140	0.015	6	1.437	21,560
801-20-32-01	1.250	2.0000	1.093	0.937	1.424	0.015	6	1.795	33,640
801-22-35-01	1.375	2.1875	1.187	1.031	1.531	0.015	6	1.937	40,000
801-24-39-01	1.500	2.4375	1.312	1.125	1.710	0.015	6	2.15 5	48,480
801-28-45-01	1.750	2.8125	1.531	1.312	1.995	0.015	6	2.51 5	66,000
801-32-51-01	2.000	3.1875	1.750	1.500	2.281	0.015	6	2.875	86,250
801-36-57-01	2.250	3.5625	1.969	1.687	2.567	0.015	6	3.235	109,150
801-40-63-01	2.500	3.9375	2.187	1.875	2.847	0.015	6	3.590	134,620
801-48-76-01	3.000	4.7500	2.625	2.250	3.421	0.015	6	4.31 2	194,040
801-64-100-01	4.000	6.2500	3.500	3.000	4.562	0.015	6	5.750	345,000
801-80-124-01	5.000	7.7500	4.375	3.750	5.706	0.015	6	7.19 0	539,250
801-96-140-01	6.000	8.7500	4.750	4.125	6.630	0.015	5	8.15 6	672,870

(801) bearings are supplied with 17- 4 PH Stainless Steel Ball. Consult Rexnord Engineering for other available materials

Model Number	B +.000 -.001	D +.0000 -.0005	W +.000 -.010	H +.003 -.003	A (Ref)	C +.005 -.005	P Deg. Max	S Ball O.D.	Limit Load Rating-Lbs.
821-04-10-01	0.2520	0.6562	0.3430	0.2500	0.4050	0.0200	12	0.5300	6,300
821-05-12-01	0.3150	0.7500	0.3750	0.2810	0.4190	0.0200	11	0.5625	7,490
821-06-13-01	0.3770	0.8125	0.4060	0.3120	0.4750	0.0250	10	0.6250	9,060
821-07-14-01	0.4400	0.9062	0.4370	0.3430	0.5290	0.0250	9	0.685 5	11,380
821-08-16-01	0.5020	1.0000	0.5000	0.3900	0.6400	0.0300	9	0.8125	15,750
821-09-18-01	0.5650	1.0937	0.5620	0.4370	0.6710	0.0300	10	0.8750	18,980
821-10-19-01	0.6270	1.1875	0.6250	0.5000	0.7390	0.0300	9	0.968 0	24,180
821-12-23-01	0.7520	1.4375	0.7500	0.5930	0.9200	0.0300	9	1.1870	36,170
821-14-25-01	0.8770	1.5625	0.8750	0.7030	0.9780	0.0300	9	1.3120	48,160
821-16-28-01	1.0020	1.7500	1.0000	0.7970	1.1180	0.0300	9	1.5000	63,100

(821) Replaceable composite ball with metallic loader slot outer race

## Split Metallic Outer Race Annular Bearings



### Features of Duralon Annular Bearings

- Size:** Standard & Metric sizes - from .500" to 6.000" inside diameter
- Load:** Typical dynamic loads - 4,000 to 20,000 psi
- Motion:** Oscillatory, pivot, slow speed full rotation, for linear consult Rexnord engine
- Friction:** Coefficients vary from .16 @ 500 psi to .07 @ 20,000 psi
- Electrical:** Filament wound back-up material of the ball is an electrical insulator
- Chemical:** Consult Rexnord engineer
- Temperature:** -65°F to +325°F for Continuous, 400°F for Intermittent

The self-lubricating composite ball consists of a woven Teflon fiber and polyester fiber liner supported by a filament wound continuous fiberglass fiber and epoxy resin matrix. The split metallic outer race is carbon steel.

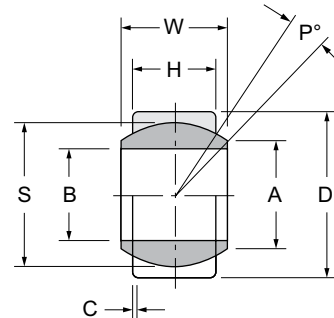

### PART NUMBER DESCRIPTION

**831 - Split Metallic Outer Race and Composite Ball**

- Static Misalignment

**838 - Split Metallic Outer Race and Composite Ball with Lined O.D.**

- Dynamic Misalignment

Model Number	Model Number	B Min	Tolerance	D Max	Tolerance	W +.000 -.005	H +.000 -.005	A (Ref)	C +.010 -.010	P Deg. Min	S Ball O.D.	Limit Load Rating-Lbs.	
831-08-14-01	838-08-14-01	0.5030	+.001	0.8750	+.000 -.0005	0.437	0.375	0.571	0.022	6	0.719	3,750	
831-12-20-01	838-12-20-01	0.7530		1.2500		0.656	0.562	0.858	0.022	6	1.080	8,430	
831-14-23-01	838-14-23-01	0.8780		1.4375		0.765	0.656	0.999	0.022	6	1.258	11,480	
831-16-26-01	838-16-26-01	1.0030		1.6250	0.875	0.750	1.140	0.022	6	1.437	15,000		
831-20-32-01	838-20-32-01	1.2530		2.0000	1.093	0.937	1.424	0.022	6	1.795	23,425		
831-22-35-01	838-22-35-01	1.3780		2.1875	1.187	1.031	1.531	0.022	6	1.937	28,350		
831-24-39-01	838-24-39-01	1.5030		2.4375	1.312	1.125	1.710	0.022	6	2.155	33,750		
831-28-45-01	838-28-45-01	1.7530		2.8125	1.531	1.312	1.995	0.022	6	2.515	45,925		
831-32-51-01	838-32-51-01	2.0030		3.1875	1.750	1.500	2.281	0.022	6	2.875	60,000		
831-36-57-01	838-36-57-01	2.2530		3.5625	1.969	1.687	2.567	0.022	6	3.235	75,900		
831-40-63-01	838-40-63-01	2.5030		3.9375	2.187	1.875	2.847	0.022	6	3.590	93,750		
831-48-76-01	838-48-76-01	3.0030		4.7500	2.625	2.250	3.421	0.022	6	4.312	135,000		
831-64-100-01	838-64-100-01	4.0030		+0.003	6.2500	+0.010	3.500	3.000	4.562	0.022	6	5.750	240,000
831-80-124-01	838-80-124-01	5.0020		+0.005	7.7500	+0.022	4.375	3.750	5.706	0.022	6	7.190	375,000
831-96-140-01	838-96-140-01	6.0030		+0.004	8.7500		4.750	4.125	6.630	0.022	5	8.156	495,000

# Actuator Nuts and Helical Bearings

**Features of Actuator Nuts and Helical Bearing**

- Size:** Consult Rexnord engineer
- Load:** Consult Rexnord engineer
- Motion:** Convert linear motion to rotary motion, rotary motion to linear motion
- Friction:** Coefficients vary from .16 @ 500 psi to .07 @ 20,000 psi
- Electrical:** Filament wound back-up material is an electrical insulator
- Chemical:** Resistant to most chemicals, consult Rexnord engineer
- Temperature:** -65°F to +325°F for Continuous, 400°F for Intermittent



When you want to convert a shaft's rotary motion to linear motion, recirculating ball screw represent the conventional solution. But now a filament-wound bearing with a helical, hex ID, fitted onto a helical, hexagonal shaft, can do the job. As the shaft rotates, the bearing follows the shaft's helix, traveling linearly along the shaft. In effect, the bearing acts like an actuator nut. Moving the shaft linearly imparts rotary motion of the bearing.



## Mounted Bearings

### 2-Bolt Flange Mounting

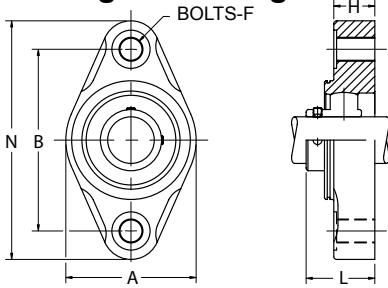

Part Number	Shaft Diameter	A	B	Bolts F	H	Shaft Protector Length L	N
DKLFXM012SP	3/4	2 7/16	3.543	3/8	51/64	1.44	4 9/16
DKLFXM013SP	13/16	2 13/16	3.898	3/8	7/8	1.5	5 1/8
DKLFXM014SP	7/8	2 13/16	3.898	3/8	7/8	1.5	5 1/8
DKLFXM015SP	15/16	2 13/16	3.898	3/8	7/8	1.5	5 1/8
DKLFXM016SP	1	2 13/16	3.898	3/8	7/8	1.5	5 1/8
DKLFXM017SP	1 1/16	3 11/32	4.606	3/8	1 1/64	1.82	5 53/64
DKLFXM018SP	1 1/8	3 11/32	4.606	3/8	1 1/64	1.82	5 53/64
DKLFXM019SP	1 3/16	3 11/32	4.606	3/8	1 1/64	1.82	5 53/64
DKLFXME020SP	1 1/4S	3 11/32	4.606	3/8	1 1/64	1.82	5 53/64
DKLFXM020SP	1 1/4	3 21/32	5.118	3/8	1 1/64	1.96	6 3/8
DKLFXM021SP	1 5/16	3 21/32	5.118	3/8	1 1/64	1.96	6 3/8
DKLFXM022SP	1 3/8	3 21/32	5.118	3/8	1 1/64	1.96	6 3/8
DKLFXM023SP	1 7/16	3 21/32	5.118	3/8	1 1/64	1.96	6 3/8
DKLFXM024SP	1 1/2	4 1/64	5.672	3/8	1 3/16	2.03	6 59/64

### 4-Bolt Flange Mounting

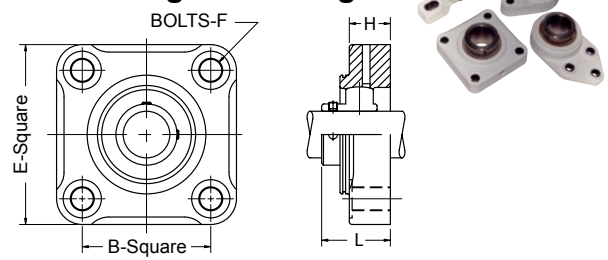

Part Number	Shaft Diameter	B	E	Bolts F	H	Shaft Protector Length L
DKLFXM013SP	13/16	2.756	3 55/64	3/8	7/8	1.5
DKLFXM014SP	7/8	2.756	3 55/64	3/8	7/8	1.5
DKLFXM015SP	15/16	2.756	3 55/64	3/8	7/8	1.5
DKLFXM016SP	1	2.756	3 55/64	3/8	7/8	1.5
DKLFXM017SP	1 1/16	3.268	4 21/64	3/8	1 1/64	1.82
DKLFXM018SP	1 1/8	3.268	4 21/64	3/8	1 1/64	1.82
DKLFXM019SP	1 3/16	3.268	4 21/64	3/8	1 1/64	1.82
DKLFXME020SP	1 1/4S	3.268	4 21/64	3/8	1 1/64	1.82
DKLFXM020SP	1 1/4	3.622	4 23/32	3/8	1 1/64	1.96
DKLFXM021SP	1 5/16	3.622	4 23/32	3/8	1 1/64	1.96
DKLFXM022SP	1 3/8	3.622	4 23/32	3/8	1 1/64	1.96
DKLFXM023SP	1 7/16	3.622	4 23/32	3/8	1 1/64	1.96
DKLFXM024SP	1 1/2	4.016	5 5/32	3/8	1 3/16	2.03

### Pillow Block

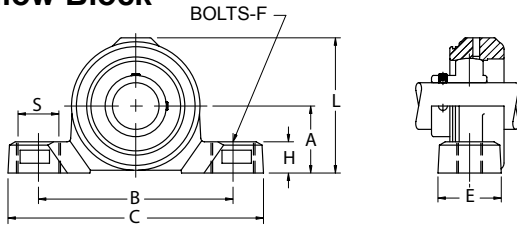

Part Number	Shaft Diameter	A	B	C	E	Bolts F	H	L	Shaft Protector Length	S
DKLPM012SP	3/4	1 5/16	3 25/32	5 1/32	1 3/16	3/8	43/64	3 11/32	1.44	7/8
DKLPM013SP	13/16	1 7/16	4 11/16	5 31/64	1 23/64	3/8	43/64	3 11/32	1.5	7/8
DKLPM014SP	7/8	1 7/16	4 11/16	5 31/64	1 23/64	3/8	43/64	3 11/32	1.5	7/8
DKLPM015SP	15/16	1 7/16	4 11/16	5 31/64	1 23/64	3/8	43/64	3 11/32	1.5	7/8
DKLPM016SP	1	1 7/16	4 11/16	5 31/64	1 23/64	3/8	43/64	3 11/32	1.5	7/8
DKLPM017SP	1 1/16	1 11/16	4 49/64	6 27/64	1 27/64	3/8	25/32	3 55/64	1.82	15/16
DKLPM018SP	1 1/8	1 11/16	4 49/64	6 27/64	1 27/64	3/8	25/32	3 55/64	1.82	15/16
DKLPM019SP	1 3/16	1 11/16	4 49/64	6 27/64	1 27/64	3/8	25/32	3 55/64	1.82	15/16
DKLPM020SP	1 1/4S	1 11/16	4 49/64	6 27/64	1 27/64	3/8	25/32	3 55/64	1.82	15/16
DKLPM020SP	1 1/4	1 7/8	4 31/32	6 37/64	1 33/64	3/8	25/32	4 1/4	1.96	15/16
DKLPM021SP	1 5/16	1 7/8	4 31/32	6 37/64	1 33/64	3/8	25/32	4 1/4	1.96	15/16
DKLPM022SP	1 3/8	1 7/8	4 31/32	6 37/64	1 33/64	3/8	25/32	4 1/4	1.96	15/16
DKLPM023SP	1 7/16	1 7/8	4 31/32	6 37/64	1 33/64	3/8	25/32	4 1/4	1.96	15/16
DKLPM024SP	1 1/2	2	5 11/32	7 9/32	1 33/64	3/8	25/32	4 13/32	2.03	15/16

### 3 Bolt Flange Bracket

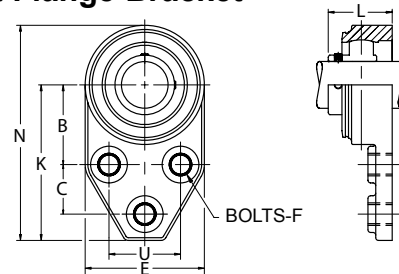

Part Number	Shaft Diameter	B	C	E	Bolts F	K	Shaft Protector Length L	N	U
DKLPM013SP	13/16	1 13/16	1 1/8	2 23/32	3/8	3 17/32	1.5	4 57/64	1 5/8
DKLPM014SP	7/8	1 13/16	1 1/8	2 23/32	3/8	3 17/32	1.5	4 57/64	1 5/8
DKLPM015SP	15/16	1 13/16	1 1/8	2 23/32	3/8	3 17/32	1.5	4 57/64	1 5/8
DKLPM016SP	1	1 13/16	1 1/8	2 23/32	3/8	3 17/32	1.5	4 57/64	1 5/8
DKLPM017SP	1 1/16	2 1/16	1 1/4	2 23/32	3/8	3 55/64	1.82	5 15/32	1 7/8
DKLPM018SP	1 1/8	2 1/16	1 1/4	3 13/64	3/8	3 55/64	1.82	5 15/32	1 7/8
DKLPM019SP	1 3/16	2 1/16	1 1/4	3 13/64	3/8	3 55/64	1.82	5 15/32	1 7/8
DKLPM020SP	1 1/4S	2 1/16	1 1/4	3 11/16	3/8	3 55/64	1.82	5 15/32	1 7/8
DKLPM020SP	1 1/4	2 3/8	1 1/4	3 11/16	7/16	4 15/64	1.96	6 5/64	2
DKLPM021SP	1 5/16	2 3/8	1 1/4	3 11/16	7/16	4 15/64	1.96	6 5/64	2
DKLPM022SP	1 3/8	2 3/8	1 1/4	3 11/16	7/16	4 15/64	1.96	6 5/64	2
DKLPM023SP	1 7/16	2 3/8	1 1/4	3 11/16	7/16	4 15/64	1.96	6 5/64	2

The Duralon spherical bearing insert is available with any Link-Belt or MB standard ball bearings housing type and/or style. Housings available are: Powder Coated Paint, Nickel Plated, Nylon Coated, Reinforced Polyamide (Black) or Polypropylene (White). The Polyamide and Polypropylene are furnished with Microban® antimicrobial product protection. (Microban is a registered trademark of the Microban Products Company)

Due to full rotation speed limitations of the Duralon bearing material, consult with Rexnord Engineering when designing these bearings into your application.



# ALL AROUND THE GLOBE,

A light gray world map is centered in the background of the main section. The map shows the outlines of continents. To the right of the map, there is a decorative graphic consisting of multiple parallel, red, chevron-like lines pointing to the right, creating a sense of movement or a signal.

# CUSTOMERS TRUST OUR PROVEN BRANDS.

A decorative graphic consisting of multiple parallel, red, chevron-like lines pointing to the right, located at the bottom left of the main section.

## WHY CHOOSE REXNORD?

When it comes to providing highly engineered products that improve productivity and efficiency for industrial applications worldwide, Rexnord is the most reliable in the industry. Commitment to customer satisfaction and superior value extend across every business function.

### Delivering Lowest Total Cost of Ownership

The highest quality products are designed to help prevent equipment downtime and increase productivity and dependable operation.

### Valuable Expertise

An extensive product offering is accompanied by global sales specialists, customer service and maintenance support teams, available anytime.

### Solutions to Enhance Ease of Doing Business

Commitment to operational excellence ensures the right products at the right place at the right time.