

SACB-4/ 8-L- 5,0PUR SCO - Distributor box



1517107

<https://www.phoenixcontact.com/us/products/1517107>

Please be informed that the data shown in this PDF document is generated from our online catalog. Please find the complete data in the user documentation. Our general terms of use for downloads are valid.



Distributor box, application: Standard, connection method: M12-SPEEDCON-socket Metal, number of slots: 4, number of positions: 5, coding: A, slot assignment: Double, status display: Yes, pnp; master cable connection: Fixed connection 180°, PUR/PVC, cable length: 5 m, shielding: no

Your advantages

- Safety in the field, thanks to molded housing and high degree of protection
- Convenient: increased machine availability thanks to quick and easy diagnostics
- Save space: distributor box with double occupancy for two sensors in one slot
- Save time, thanks to installation with SPEEDCON fast locking system

Commercial data

Item number	1517107
Packing unit	1 pc
Minimum order quantity	1 pc
Sales key	BF42
Product key	BF3CCA
Catalog page	Page 264 (C-2-2019)
GTIN	4017918967772
Weight per piece (including packing)	924.3 g
Weight per piece (excluding packing)	869.3 g
Customs tariff number	85444290
Country of origin	DE

SACB-4/ 8-L- 5,0PUR SCO - Distributor box

1517107

<https://www.phoenixcontact.com/us/products/1517107>

Pin assignment

Slot/position = Wire color or connection	1 / 4 (A) = WH
	1 / 2 (B) = GYPK
	2 / 4 (A) = GN
	2 / 2 (B) = RDBU
	3 / 4 (A) = YE
	3 / 2 (B) = WHGN
	4 / 4 (A) = GY
	4 / 2 (B) = BNGN
	1-4 / 1 (+ 24 V) = BN
	1-4 / 3 (0 V) = BU
	1-4 / 5 (PE) = GNYE

Signaling

Status display present	Yes
------------------------	-----

Electrical properties

Max. operating voltage U_{max}	30 V DC
Local diagnostics	Supply voltage per module Green LED
	Status display I/O Yellow LED
Nominal voltage U_N	24 V DC
Rated current, total	12 A
Max. current carrying capacity per path	2 A
Current carrying capacity per slot	4 A

Cable/line

Cable length	5 m
--------------	-----

PUR/PVC black [PUR]

Dimensional drawing	
Cable weight	122 kg/km
UL AWM Style	20549
Number of positions	11
Shielded	no
Cable type	PUR/PVC black [PUR]
Conductor structure signal line	28x 0.15 mm
AWG signal line	20

SACB-4/ 8-L- 5,0PUR SCO - Distributor box



1517107

<https://www.phoenixcontact.com/us/products/1517107>

Conductor cross section	8x 0.5 mm ² (Signal line)
	3x 1 mm ² (power line)
Wire diameter incl. insulation	1.5 mm ±0.1 mm (Signal line)
	2.1 mm ±0.1 mm (power line)
External cable diameter	8.7 mm ±0.2 mm
Outer sheath, material	PUR
External sheath, color	black RAL 9005
Conductor material	Bare Cu litz wires
Material wire insulation	PVC
Single wire, color	brown, blue, green/yellow, white, green, yellow, gray, gray/pink, red/blue, white/green, brown/green
Inner sheath thickness	≥ 0.15 mm
Thickness, outer sheath	≥ 0.38 mm
Overall twist	Wires twisted in layers
Nominal voltage, cable	300 V
Test voltage	2000 V
Minimum bending radius, fixed installation	7.5 x D
Minimum bending radius, flexible installation	10 x D
Smallest bending radius, fixed installation	66 mm
Smallest bending radius, movable installation	87 mm
Max. bending cycles	1500000
Flame resistance	DIN EN 50265
Resistance to oil	according to VDE 0472 Part 803
Other resistance	Highly resistant to acids, alkaline solutions and solvents
Special properties	Silicone-free
Ambient temperature (operation)	-40 °C ... 90 °C (cable, fixed installation)
	-5 °C ... 80 °C (Cable, flexible installation)
	80 °C (in acc. with UL)

Standards and regulations

Standard designation	M12 connector
Standards/specifications	IEC 61076-2-101

Environmental and real-life conditions

Ambient conditions

Degree of protection	IP65
	IP67
	IP69K
Ambient temperature (operation)	-30 °C ... 90 °C

SACB-4/ 8-L- 5,0PUR SCO - Distributor box



1517107

<https://www.phoenixcontact.com/us/products/1517107>

Drawings

Schematic diagram

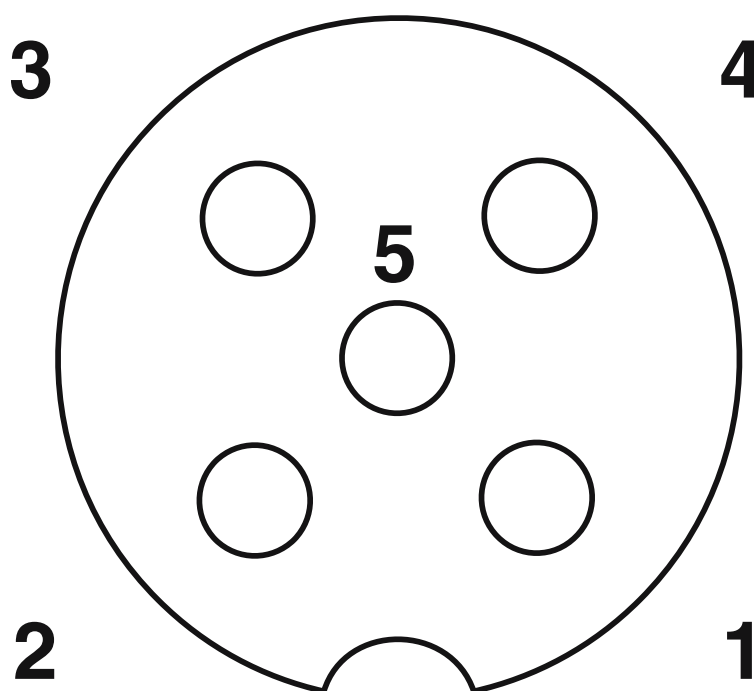

M12 slot, socket, 5-pos.

SACB-4/ 8-L- 5,0PUR SCO - Distributor box



1517107

<https://www.phoenixcontact.com/us/products/1517107>

Circuit diagram

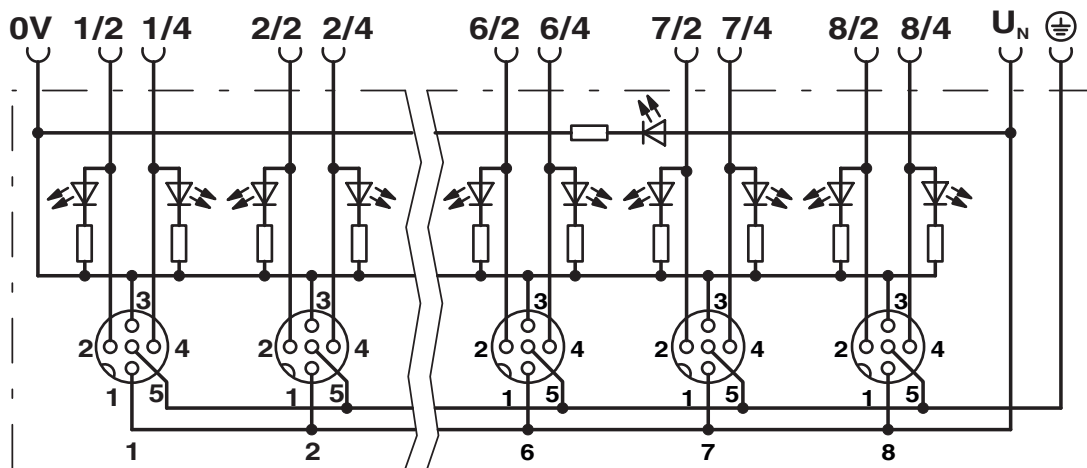

SACB-4/ 8-L- 5,0PUR SCO - Distributor box

1517107

<https://www.phoenixcontact.com/us/products/1517107>



Dimensional drawing

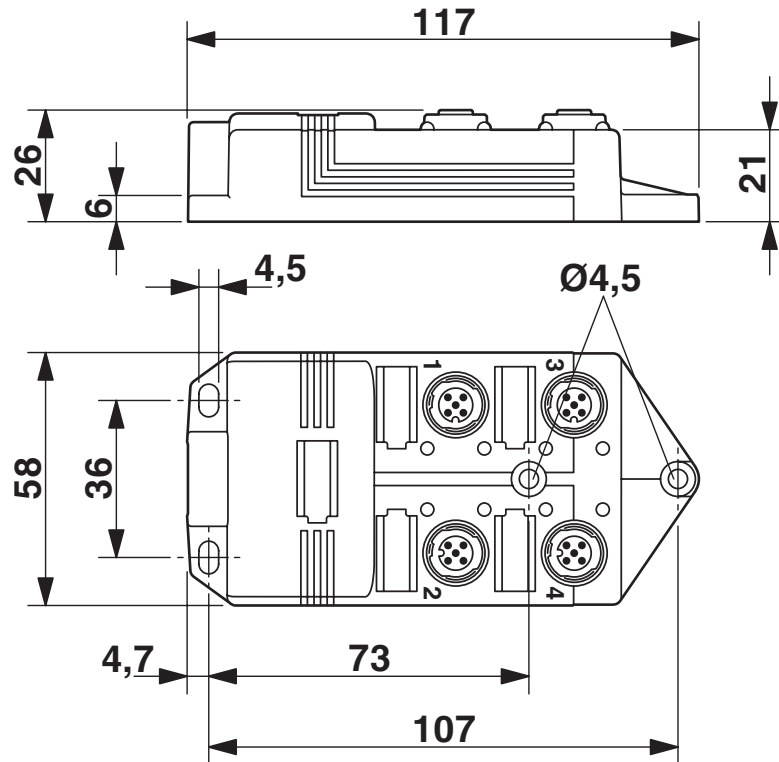

SACB-4/ 8-L- 5,0PUR SCO - Distributor box





1517107

<https://www.phoenixcontact.com/us/products/1517107>

Approvals

To download certificates, visit the product detail page: <https://www.phoenixcontact.com/us/products/1517107>

 cUL Recognized Approval ID: FILE E 118976				
	Nominal voltage U_N	Nominal current I_N	Cross section AWG	Cross section mm^2
	24 V	3 A	-	-

 UL Recognized Approval ID: FILE E 118976				
	Nominal voltage U_N	Nominal current I_N	Cross section AWG	Cross section mm^2
	24 V	3 A	-	-

cULus Recognized				
-------------------------	--	--	--	--

SACB-4/ 8-L- 5,0PUR SCO - Distributor box



1517107

<https://www.phoenixcontact.com/us/products/1517107>

Classifications

ECLASS

ECLASS-11.0	27440108
ECLASS-12.0	27440108
ECLASS-13.0	27440108

ETIM

ETIM 9.0	EC002585
----------	----------

UNSPSC

UNSPSC 21.0	31251500
-------------	----------

SACB-4/ 8-L- 5,0PUR SCO - Distributor box



1517107

<https://www.phoenixcontact.com/us/products/1517107>

Environmental product compliance

China RoHS	Environmentally friendly use period: unlimited = EFUP-e
	No hazardous substances above threshold values

SACB-4/ 8-L- 5,0PUR SCO - Distributor box



1517107

<https://www.phoenixcontact.com/us/products/1517107>

Accessories

PROT-MS SCO - Screw plug

1553129

<https://www.phoenixcontact.com/us/products/1553129>



M12 screw plug with fast-locking system for unoccupied M12 female connectors of sensor/actuator cables, boxes, and flush-type connectors

UC-EM (17,5X9) - Snap-in markers

0827490

<https://www.phoenixcontact.com/us/products/0827490>



Snap-in markers, Sheet, white, unlabeled, can be labeled with: BLUEMARK ID, BLUEMARK ID COLOR, BLUEMARK CLED, BLUEMARK LED, CMS-P1-PLOTTER, PLOTMARK, mounting type: snapped, lettering field size: 17.5 x 9 mm, Number of individual labels: 20

SACB-4/ 8-L- 5,0PUR SCO - Distributor box



1517107

<https://www.phoenixcontact.com/us/products/1517107>

UC-EM (17,5X9) CUS - Snap-in markers

0828238

<https://www.phoenixcontact.com/us/products/0828238>



Snap-in markers, can be ordered: by sheet, white, labeled according to customer specifications, mounting type: snapped into marker carrier, lettering field size: 17.5 x 9 mm, Number of individual labels: 20

UCT-EM (17,5X9) - Snap-in markers

0801491

<https://www.phoenixcontact.com/us/products/0801491>



Snap-in markers, Sheet, white, unlabeled, can be labeled with: TOPMARK NEO, TOPMARK LASER, BLUEMARK ID COLOR, BLUEMARK ID, BLUEMARK CLED, THERMOMARK PRIME, THERMOMARK CARD 2.0, THERMOMARK CARD, mounting type: snapped, lettering field size: 17.5 x 9 mm, Number of individual labels: 24

SACB-4/ 8-L- 5,0PUR SCO - Distributor box

1517107

<https://www.phoenixcontact.com/us/products/1517107>



UCT-EM (17,5X9) CUS - Snap-in markers

0801575

<https://www.phoenixcontact.com/us/products/0801575>

UniCard sheet, for labeling devices from other manufacturers, for overview table see download area, labeled according to customer specifications



UC-EM (17,5X9) YE - Snap-in markers

0827494

<https://www.phoenixcontact.com/us/products/0827494>

Snap-in markers, Sheet, yellow, unlabeled, can be labeled with: BLUEMARK ID COLOR, BLUEMARK ID, BLUEMARK CLED, PLOTMARK, CMS-P1-PLOTTER, mounting type: snapped, lettering field size: 17.5 x 9 mm, Number of individual labels: 20

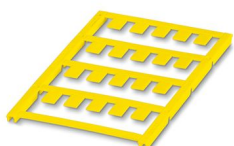

SACB-4/ 8-L- 5,0PUR SCO - Distributor box

1517107

<https://www.phoenixcontact.com/us/products/1517107>



UC-EM (17,5X9) YE CUS - Snap-in markers

0828239

<https://www.phoenixcontact.com/us/products/0828239>

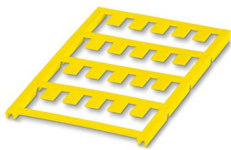

Snap-in markers, can be ordered: by sheet, yellow, labeled according to customer specifications, mounting type: snapped into marker carrier, lettering field size: 17.5 x 9 mm, Number of individual labels: 20

UCT-EM (17,5X9) YE - Snap-in markers

0801492

<https://www.phoenixcontact.com/us/products/0801492>



Snap-in markers, Sheet, yellow, unlabeled, can be labeled with: TOPMARK NEO, TOPMARK LASER, BLUEMARK ID COLOR, BLUEMARK ID, BLUEMARK CLED, THERMOMARK PRIME, THERMOMARK CARD 2.0, THERMOMARK CARD, mounting type: snapped, lettering field size: 17.5 x 9 mm, Number of individual labels: 24

SACB-4/ 8-L- 5,0PUR SCO - Distributor box

1517107

<https://www.phoenixcontact.com/us/products/1517107>



UCT-EM (17,5X9) YE CUS - Snap-in markers

0801576

<https://www.phoenixcontact.com/us/products/0801576>

UniCard sheet, for labeling devices from other manufacturers, for overview table see download area, labeled according to customer specifications



UTA 107 - DIN rail adapter

2853983

<https://www.phoenixcontact.com/us/products/2853983>

Universal DIN rail adapter, for screwing on switchgear



SACB-4/ 8-L- 5,0PUR SCO - Distributor box



1517107

<https://www.phoenixcontact.com/us/products/1517107>

TSD 04 SAC - Torque screwdriver

1208429

<https://www.phoenixcontact.com/us/products/1208429>



Torque screwdriver, with preset torque of 0.4 Nm and 4 mm hexagonal drive for M12 connectors

TSD-M 1,2NM - Torque screwdriver

1212224

<https://www.phoenixcontact.com/us/products/1212224>



Torque screw driver, accuracy as per EN ISO 6789 standard, adjustable from 0.3 - 1.2 Nm

SACB-4/ 8-L- 5,0PUR SCO - Distributor box



1517107

<https://www.phoenixcontact.com/us/products/1517107>

TSD-M SAC-BIT ADAPTER - Adapter insert

1212600

<https://www.phoenixcontact.com/us/products/1212600>



Adapter bit for TSD-M...torque tools, E6.3-1/4" drive with 4 mm hexagon to accommodate SAC bits

SAC BIT M12-D15 - Tool

1208432

<https://www.phoenixcontact.com/us/products/1208432>



Nut for assembling sensor/actuator cables with M12 connector and M12 connectors for assembly, with a knurl diameter of 15 mm, for 4 mm hexagonal drive

SACB-4/ 8-L- 5,0PUR SCO - Distributor box

1517107

<https://www.phoenixcontact.com/us/products/1517107>



SACC BIT M12-D20 - Tool

1208445

<https://www.phoenixcontact.com/us/products/1208445>

Nut for assembling M12 connectors for assembly with a knurl diameter of 20 mm, for 4 mm hexagonal drive



Phoenix Contact 2023 © - all rights reserved

<https://www.phoenixcontact.com>

Phoenix Contact USA
586 Fulling Mill Road
Middletown, PA 17057, United States
(+717) 944-1300
info@phoenixcon.com