

# E3ZM

## Stainless Steel Housing Ideal for Food Industry **PAT Pending**



- Strong resistance against detergents, disinfectants, and jet liquid flow.
- Product lineup includes BGS Reflective Models and Through-beam Models with built-in slits.
- Certified by Ecolab Europe.



Be sure to read *Safety Precautions* on page 13.

For the most recent information on models that have been certified for safety standards, refer to your OMRON website.

## Features



### Withstands Detergent and Disinfectant Spray

We used SUS316L for the case and the best material for all parts to achieve **200 times the durability of the E3Z** (in 1.5% solution of sodium hydroxide at 70°C) to make the E3ZM suitable for the cleaning conditions of food-processing machinery.



### Superior Protective Structure

The first **IP69K\*** (DIN 40050-9) protective structure in the world for a square metal photoelectric sensor. Suitable for high-temperature, high-pressure jet water spray cleaning applications.

\* Refer to the footnote on page 5 (ratings and specifications table).

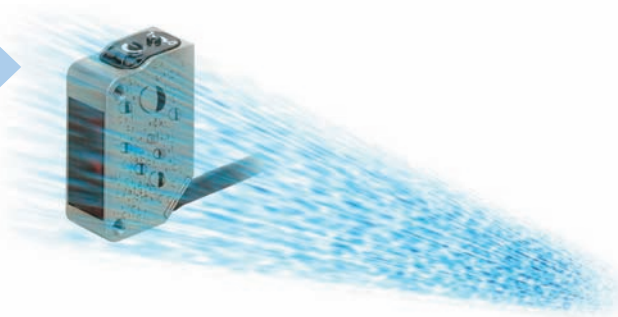

### Shape and Markings Designed for Greater Hygiene

Few indentations in the shape means less dust and water can collect, making the E3ZM more hygienic. No labels have been used in order to **prevent foreign matter contaminating food** products. The E3ZM model and lot numbers are imprinted using a laser marker.



## Structural Design That Provides Excellent Environment-resistance\*

### Waterproofing ring: Fluorine rubber

Excellent resistance to detergents and disinfectants.

### Optical plate: Polymethylmethacrylate (PMMA)

Excellent resistance to detergents and disinfectants. High transparency and other qualities give PMMA excellent optical characteristics.

### Seal

The seal provides the durability to high-temperature and high-pressure water that complies with IP69K.

### Indicator cover: Polyetherimide (PEI)

Excellent resistance to detergents and disinfectants.

### Sensitivity adjustment and mode selector switch: Polyetheretherketone (PEEK)

Excellent resistance to detergents and disinfectants. Also has excellent abrasion resistance.

### Case: SUS316L

Excellent corrosion resistance to many chemical reagents.

### Cable: Polyvinylchloride

Excellent resistance to detergents and disinfectants.

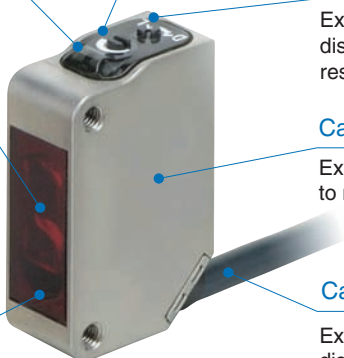

\*Do not use the E3ZM in an oily environment.

## Unique Members of the E3ZM Family

### BGS Reflective Models

#### E3ZM-LS6□H/-LS8□H

Three models with different fixed sensitivity (rated sensing distances) have been created. These models cover the sensing ranges of the E3Z-LS61.

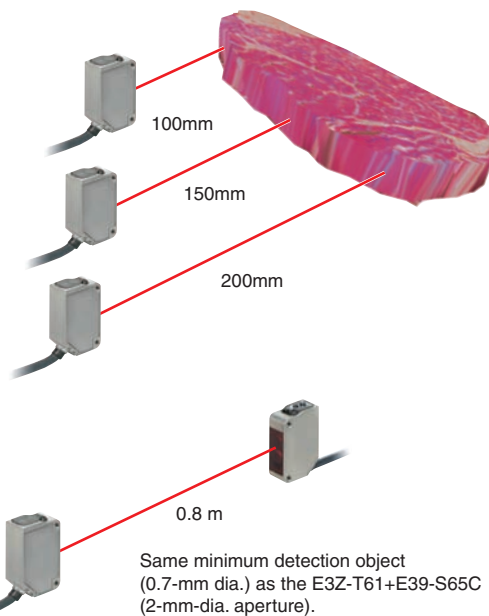

### Through-beam Inner Aperture Models

#### E3ZM-T63

Fine beam without attaching an external aperture. This eliminates malfunctions from residual water drops, even immediately after washing.

## A Better Fit for the Application

The E3ZM can be used in those harsh cleaning environments in which the E3Z was difficult to use. E3ZM passed the material resistance tests and is certified by Ecolab.

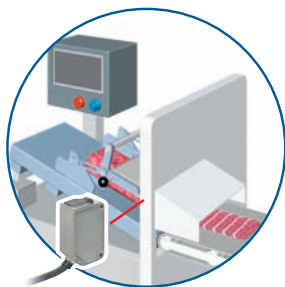







Processing and wrapping of meat or raw food products

<p>Ecolab GmbH &amp; Co. OHG R.D. Box 13 54 06 D-40551 Düsseldorf certifies that for</p> <p>OMRON Manufacturing of Germany GmbH Carl-Benz-Strasse 4 71154 Nutringen</p> <p><b>material resistance tests</b></p> <p>were performed with cleaning substances P3-topax 56, P3-topax 66, P3-topax 91, P3 Topactiv DES and demineralized water as a zero reference factor.</p> <p>The material resistance of the tested series</p> <p>Photoelectric Sensor E3ZM</p> <p>to the P3 products used in the test can be considered to be positive according to the cleaning procedure mentioned overleaf.</p> <p>Düsseldorf, 14th February 2006</p> <p>Ecolab GmbH &amp; Co. OHG</p> <p>L.V.  L.V. </p> <p>Thomas Tyborski Reinhold Lauff</p>	<p>This certificate is based on:</p> <ul style="list-style-type: none"> <li>documented test procedures (test no.: FAE/P3-E Nr. 40-1)</li> <li>according to material resistance</li> <li>defined product descriptions.</li> <li>standardized cleaning procedure</li> </ul> <p><b>Test procedure</b> Ecolab-test FAE Nr. 40-1</p> <p><b>Dipping test:</b></p> <ul style="list-style-type: none"> <li>Complete immersion in solution/liquid</li> </ul> <p><b>Test period:</b></p> <ul style="list-style-type: none"> <li>10 days</li> </ul> <p><b>Temperature:</b></p> <ul style="list-style-type: none"> <li>room temperature (constant)</li> </ul> <p><b>Analysis:</b></p> <ul style="list-style-type: none"> <li>Visual judgement like swelling, brittleness.</li> <li>compliance to zero-reference factor (demineralized water).</li> <li>Photometric documentation</li> </ul> <p><b>Product specifications:</b></p> <p><b>P3-topax 56:</b> Acid foam cleaning substance for food industry</p> <p><b>P3-topax 66:</b> Alkaline cleaning detergent with active chlorine for machine-cleaning in food and beverage industry</p> <p><b>P3-topax 91:</b> Neutral disinfection agent based on quaternary ammonium compounds (QAC) for food industry</p> <p><b>P3-topactiv DES:</b> Acid-disinfectant based on Peroxalic Acid and Hydrogen Peroxide for the food and beverage industry</p> <p><b>Cleaning plan for food and beverage industry*</b></p> <ul style="list-style-type: none"> <li> <b>Rinsing with water 40 – 50°C</b> Rinsing with low pressure. Rinsing from top to bottom in the direction of the drains. Cleaning of the drains.</li> <li> <b>Scrubbing from bottom to top:</b> alkaline P3-topax 66 2 – 5 % daily acid: P3-topax 56 2 % on demand temperature: cold up to 40°C contact time: 15 min. recommended</li> <li> <b>Rinsing with water 40 – 50°C</b> Rinsing from top to bottom with low pressure</li> <li> <b>Spray disinfection</b> P3-topax 91 1-2 %, 30 -60 minutes</li> <li><b>Foam disinfection</b> P3-topactiv DES 1-2 %, 10-30 minutes</li> </ul>
--	---

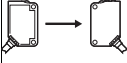
## Ordering Information

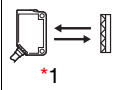
### Sensors (Refer to Dimensions on page 15.)

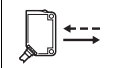
Red light  Infrared light

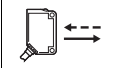
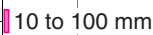
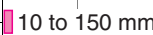
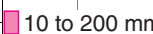
Sensing method	Appearance	Connection method	Sensing distance	Model		
				NPN output	PNP output	
Through-beam (Emitter + Receiver)		Pre-wired (2 m)		15 m	<b>E3ZM-T61 2M</b> Emitter E3ZM-T61-L 2M Receiver E3ZM-T61-D 2M	<b>E3ZM-T81 2M</b> Emitter E3ZM-T81-L 2M Receiver E3ZM-T81-D 2M
		Connector (M8, 4 pins)			<b>E3ZM-T66</b> Emitter E3ZM-T66-L Receiver E3ZM-T66-D	<b>E3ZM-T86</b> Emitter E3ZM-T86-L Receiver E3ZM-T86-D
		Pre-wired (2 m)		0.8 m (apertures built in)	<b>E3ZM-T63 2M</b> Emitter E3ZM-T63-L 2M Receiver E3ZM-T63-D 2M	<b>E3ZM-T83 2M</b> Emitter E3ZM-T83-L 2M Receiver E3ZM-T83-D 2M
		Connector (M8, 4 pins)			<b>E3ZM-T68</b> Emitter E3ZM-T68-L Receiver E3ZM-T68-D	<b>E3ZM-T88</b> Emitter E3ZM-T88-L Receiver E3ZM-T88-D
Retro-reflective with MSR function		Pre-wired (2 m)		4 m (100 mm) <sup>*2</sup>	<b>E3ZM-R61 2M</b>	<b>E3ZM-R81 2M</b>
		Connector (M8, 4 pins)			(Using E39-R1S)	<b>E3ZM-R66</b>
Diffuse-reflective		Pre-wired (2 m)		1 m	<b>E3ZM-D62 2M</b>	<b>E3ZM-D82 2M</b>
		Connector (M8, 4 pins)			<b>E3ZM-D67</b>	<b>E3ZM-D87</b>
BGS reflective (fixed distance)		Pre-wired (2 m)		10 to 100 mm	<b>E3ZM-LS61H 2M</b>	<b>E3ZM-LS81H 2M</b>
		Connector (M8, 4 pins)			<b>E3ZM-LS66H</b>	<b>E3ZM-LS86H</b>
		Pre-wired (2 m)		10 to 150 mm	<b>E3ZM-LS62H 2M</b>	<b>E3ZM-LS82H 2M</b>
		Connector (M8, 4 pins)			<b>E3ZM-LS67H</b>	<b>E3ZM-LS87H</b>
		Pre-wired (2 m)		10 to 200 mm	<b>E3ZM-LS64H 2M</b>	<b>E3ZM-LS84H 2M</b>
		Connector (M8, 4 pins)			<b>E3ZM-LS69H</b>	<b>E3ZM-LS89H</b>

\*1. The Reflector is sold separately. Select the Reflector model most suited to the application.

\*2. Values in parentheses indicate the minimum required distance between the Sensor and Reflector.

### Accessories (Order Separately)

**Reflectors** (A Reflector is required for each Retro-reflective Sensor: A Reflector is not provided with the Sensor. Be sure to order a Reflector.)









(Refer to Dimensions on E39-L/E39-S/E39-R.)

Name	E3ZM-R Sensing distance *		Model	Quantity	Remarks
	Rated value	Reference value			
Reflector	3 m (100 mm)	---	<b>E39-R1</b>	1	<ul style="list-style-type: none"> <li>• Reflectors are not provided with Retro-reflective models.</li> <li>• The MSR function is enabled.</li> </ul>
	4 m (100 mm)	---	<b>E39-R1S</b>	1	
	---	5 m (100 mm)	<b>E39-R2</b>	1	
	---	2.5 m (100 mm)	<b>E39-R9</b>	1	
	---	3.5 m (100 mm)	<b>E39-R10</b>	1	
Fog Preventive Coating	---	3 m (100 mm)	<b>E39-R1K</b>	1	
Small Reflector	---	1.5 m (50 mm)	<b>E39-R3</b>	1	
Tape Reflector	---	700 mm (150 mm)	<b>E39-RS1</b>	1	
	---	1.1 m (150 mm)	<b>E39-RS2</b>	1	
	---	1.4 m (150 mm)	<b>E39-RS3</b>	1	

Note: If you use the Reflector at any distance other than the rated distance, make sure that the stability indicator lights properly when you install the Sensor.

\* Values in parentheses indicate the minimum required distance between the Sensor and Reflector.

**Mounting Brackets** A Mounting Bracket is not enclosed with the Sensor. Order a Mounting Bracket separately if required.  
 (Refer to Dimensions on E39-L/F39-L/E39-S/E39-R.)

Appearance	Model (Material)	Quantity	Remarks	Appearance	Model (Material)	Quantity	Remarks
	E39-L153 (SUS304) *1	1	Mounting Brackets		E39-L98 (SUS304) *2	1	Metal Protective Cover Bracket
	E39-L104 (SUS304) *1	1			E39-L150 (SUS304)	1 set	(Sensor adjuster)
	E39-L43 (SUS304) *2	1	Horizontal Mounting Bracket		E39-L151 (SUS304)	1 set	Easily mounted to the aluminum frame rails of conveyors and easily adjusted.
	E39-L142 (SUS304) *2	1	Horizontal Protective Cover Bracket				For left to right adjustment
	E39-L44 (SUS304)	1	Rear Mounting Bracket		E39-L144 (SUS304) *2	1	Compact Protective Cover Bracket

Note: When using a Through-beam Sensor, order one Mounting Bracket for the Receiver and one for the Emitter.



\*1. Cannot be used for Standard Connector models with mounting surface on the bottom. In that case, use Pre-wired Connector models.

\*2. Cannot be used for Standard Connector models.

**Sensor I/O Connectors (Sockets on One Cable End)**

(Models for Connectors: A Connector is not provided with the Sensor. Be sure to order a Connector separately.)

(Refer to Dimensions on XS3.)

Size	Cable	Appearance	Cable type	Model	
M8 (4 pins) *1	Standard	Straight *2 	2 m	4-wire	XS3F-E421-402-A
			5 m		XS3F-E421-405-A
		L-shaped *2 *3 	2 m		XS3F-E422-402-A
			5 m		XS3F-E422-405-A

Note: When using a Through-beam Sensor, order one Mounting Bracket for the Receiver and one for the Emitter.

\*1. Cable specifications: Outer coating material: PVC, Nut material: Stainless steel, Degree of protection: IP67 (IEC 60529)

\*2. The connector will not rotate after connecting.

\*3. The cable is fixed at an angle of 180° from the sensor emitter/receiver surface.

## Ratings and Specifications

Sensing method		Through-beam		Retro-reflective with MSR function	Diffuse-reflective Models
Model	NPN output	E3ZM-T61 E3ZM-T66	E3ZM-T63 E3ZM-T68	E3ZM-R61 E3ZM-R66	E3ZM-D62 E3ZM-D67
Item	PNP output	E3ZM-T81 E3ZM-T86	E3ZM-T83 E3ZM-T88	E3ZM-R81 E3ZM-R86	E3ZM-D82 E3ZM-D87
Sensing distance		15 m	0.8 m	4 m [100 mm] (Using E39-R1S) 3 m [100 mm] (Using E39-R1)	1 m (White paper 300 × 300 mm)
Spot diameter (typical)		---			
Standard sensing object		Opaque: 12-mm dia. min.	Opaque: 2-mm dia. min.	Opaque: 75-mm dia. min.	---
Differential travel		---			20% of sensing distance max.
Black/white error		---			
Directional angle		Emitter, Receiver: 3° to 15°		Sensor: 3° to 10° Reflector: 30°	---
Light source (wavelength)		Infrared LED (870 nm)		Red LED (660 nm)	Infrared LED (860 nm)
Power supply voltage		10 to 30 VDC, including 10% ripple (p-p)			
Current consumption		40 mA max. (Emitter 20 mA max., Receiver 20 mA max.)		25 mA max.	
Control output		Load power supply voltage: 30 VDC max., Load current: 100 mA max. (Residual voltage: 2 V max.) Open-collector output (NPN/PNP output depending on model) Light-ON/Dark-ON switch selectable			
Protection circuits		Reversed power supply polarity protection, Output short-circuit protection, and Reversed output polarity protection		Reversed power supply polarity protection, Output short-circuit protection, Mutual interference prevention, and Reversed output polarity protection	
Response time		Operate or reset: 1 ms max.			
Sensitivity adjustment		One-turn adjuster			
Ambient illumination (Receiver side)		Incandescent lamp: 3,000 lx max., Sunlight: 10,000 lx max.			
Ambient temperature range		Operating: -25 to 55°C, Storage: -40 to 70°C (with no icing or condensation)			
Ambient humidity range		Operating: 35% to 85%, Storage: 35% to 95% (with no condensation)			
Insulation resistance		20 MΩ min. at 500 VDC			
Dielectric strength		1,000 VAC, 50/60 Hz for 1 min			
Vibration resistance		Destruction: 10 to 55 Hz, 1.5-mm double amplitude for 2 hours each in X, Y, and Z directions			
Shock resistance		Destruction: 500 m/s <sup>2</sup> 3 times each in X, Y, and Z directions			
Degree of protection *		IEC: IP67, DIN 40050-9: IP69K			
Connection method		Pre-wired cable (standard length: 2 m) M8 4-pin Connector			
Indicator		Operation indicator (yellow), Stability indicator (green) (Emitter has only power supply indicator (green).)			
Weight (packed state)	Pre-wired models (with 2-m cable)	Approx. 150 g		Approx. 90 g	
	Connector models	Approx. 60 g		Approx. 40 g	
Materials	Case	SUS316L			
	Lens	PMMA (polymethylmethacrylate)			
	Display	PEI (Polyetherimide)			
	Sensitivity adjustment and mode selector switch	PEEK (polyetheretherketone)			
	Seals	Fluoro rubber			
Accessories		Instruction sheet (Note: Reflectors and Mounting Brackets are sold separately.)			

\* IP69K Degree of Protection Specifications

IP69K is a protection specification stipulated by DIN 40050 Part 9 of the German standards.

The test item is sprayed with 80°C water from a nozzle of a specified shape at a water pressure of 80 to 100 bar. The amount of water is 14 to 16 liters per minute.

The distance between the test item and the nozzle is 10 to 15 cm. The water is discharged at angles of 0°, 30°, 60°, and 90° from the horizontal plane for 30 seconds at each angle while the test item is rotated horizontally.

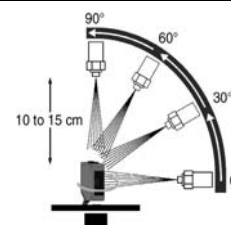

		BGS Reflective Models		
Model	Sensing method			
	NPN output	E3ZM-LS61H E3ZM-LS66H	E3ZM-LS62H E3ZM-LS67H	E3ZM-LS64H E3ZM-LS69H
Item	PNP output	E3ZM-LS81H E3ZM-LS86H	E3ZM-LS82H E3ZM-LS87H	E3ZM-LS84H E3ZM-LS89H
<b>Sensing distance</b>		10 to 100 mm (White paper 100 × 100 mm)	10 to 150 mm (White paper 100 × 100 mm)	10 to 200 mm (White paper 100 × 100 mm)
<b>Spot diameter (typical)</b>		4-mmdia. at sensing distance of 100 mm	12-mmdia. at sensing distance of 150 mm	18-mmdia. at sensing distance of 200 mm
<b>Standard sensing object</b>		---		
<b>Differential travel</b>		3% of sensing distance max.	15% of sensing distance max.	20% of sensing distance max.
<b>Black/white error</b>		5% of sensing distance max.	10% of sensing distance max.	20% of sensing distance max.
<b>Directional angle</b>		---		
<b>Light source (wavelength)</b>		Red LED (650 nm)	Red LED (660 nm)	
<b>Power supply voltage</b>		10 to 30 VDC, including 10% ripple (p-p)		
<b>Current consumption</b>		25 mA max.		
<b>Control output</b>		Load power supply voltage: 30 VDC max., Load current: 100 mA max. (Residual voltage: 2 V max.) Open-collector output (NPN/PNP output depending on model) Light-ON/Dark-ON cable connection selectable		
<b>Protection circuits</b>		Reversed power supply polarity protection, Output short-circuit protection, Reversed output polarity protection, Mutual interference protection		
<b>Response time</b>		Operate or reset: 1 ms max.		
<b>Sensitivity adjustment</b>		---		
<b>Ambient illumination (Receiver side)</b>		Incandescent lamp: 3,000 lx max., Sunlight: 10,000 lx max.		
<b>Ambient temperature range</b>		Operating: -25 to 55°C, Storage: -40 to 70°C (with no icing or condensation)		
<b>Ambient humidity range</b>		Operating: 35% to 85%, Storage: 35% to 95% (with no condensation)		
<b>Insulation resistance</b>		20 MΩ min. at 500 VDC		
<b>Dielectric strength</b>		1,000 VAC, 50/60 Hz for 1 min		
<b>Vibration resistance</b>		Destruction: 10 to 55 Hz, 1.5-mm double amplitude for 2 hours each in X, Y, and Z directions		
<b>Shock resistance</b>		Destruction: 500 m/s <sup>2</sup> 3 times each in X, Y, and Z directions		
<b>Degree of protection *</b>		IEC: IP67, DIN 40050-9: IP69K		
<b>Connection method</b>		Pre-wired cable (standard length: 2 m) M8 4-pin Connector		
<b>Indicator</b>		Operation indicator (yellow), Stability indicator (green)		
<b>Weight (packed state)</b>	<b>Pre-wired models (with 2-m cable)</b>	Approx. 90 g		
	<b>Connector models</b>	Approx. 40 g		
<b>Materials</b>	<b>Case</b>	SUS316L		
	<b>Lens</b>	PMMA (polymethylmethacrylate)		
	<b>Display</b>	PEI (Polyetherimide)		
	<b>Seals</b>	Fluoro rubber		
<b>Accessories</b>		Instruction sheet (Note: Mounting Brackets are sold separately.)		

\* IP69K Degree of Protection Specifications

IP69K is a protection specification stipulated by DIN 40050 Part 9 of the German standards.

The test item is sprayed with 80°C water from a nozzle of a specified shape at a water pressure of 80 to 100 bar. The amount of water is 14 to 16 liters per minute.

The distance between the test item and the nozzle is 10 to 15 cm. The water is discharged at angles of 0°, 30°, 60°, and 90° from the horizontal plane for 30 seconds at each angle while the test item is rotated horizontally.

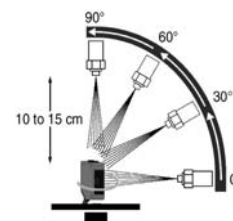

## Engineering Data (Reference Value)

### Parallel Operating Range

#### Through-beam Models

##### E3ZM-T□1(T□6)

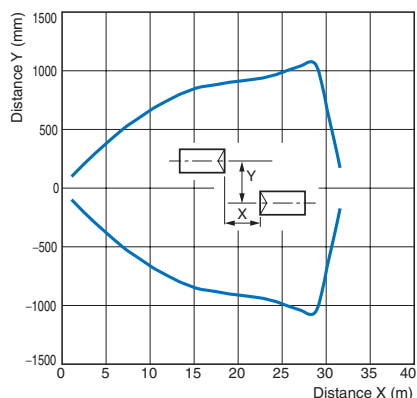

##### E3ZM-T□3(T□8)

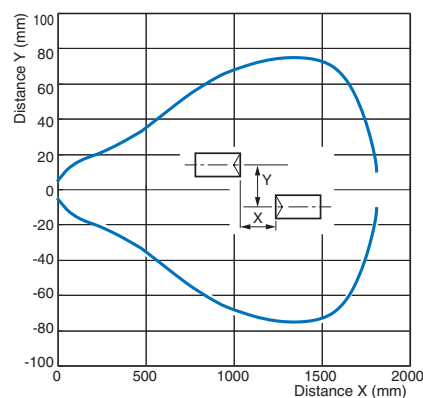

#### Retro-reflective Models

##### E3ZM-R□1(R□6)

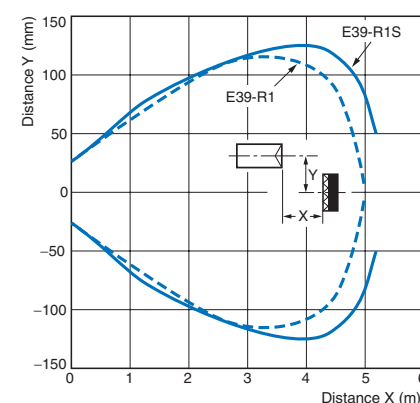

### Operating Range

#### Diffuse-reflective Models

##### E3ZM-D□2(D□7)

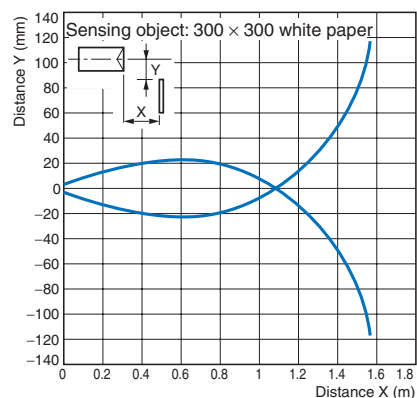

#### BGS Reflective Models

##### E3ZM-LS□1H(LS□6H), Top to Bottom

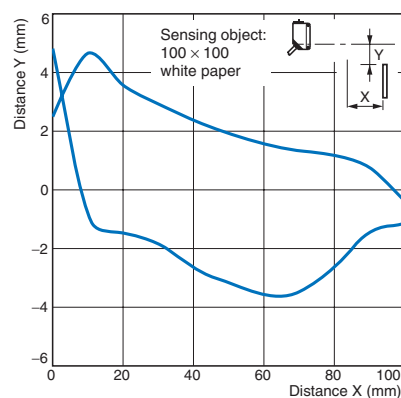

##### E3ZM-LS□1H(LS□6H), Left to Right

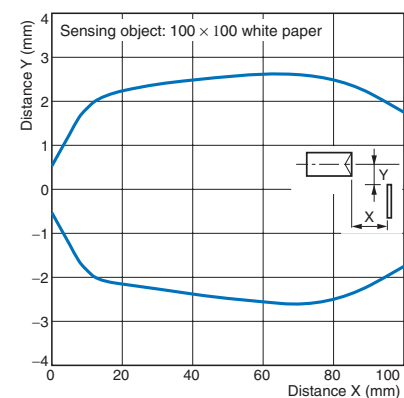

##### E3ZM-LS□2H(LS□7H), Top to Bottom

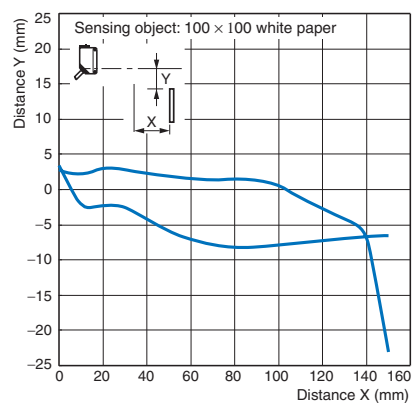

##### E3ZM-LS□2H(LS□7H), Left to Right

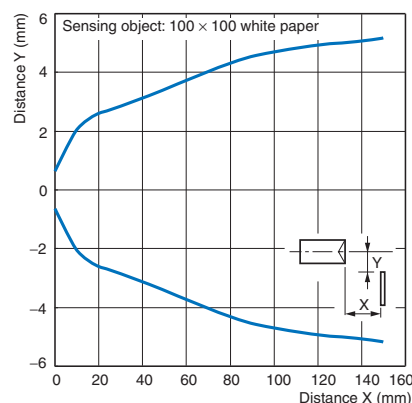

##### E3ZM-LS□4H(LS□9H), Top to Bottom

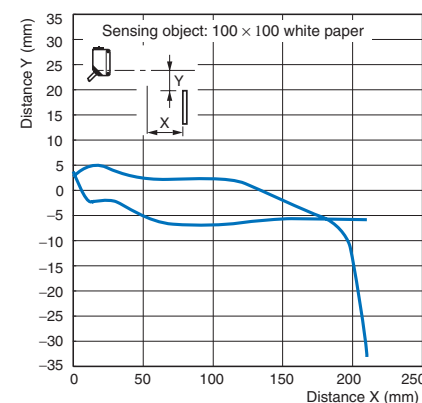

##### E3ZM-LS□4H(LS□9H), Left to Right

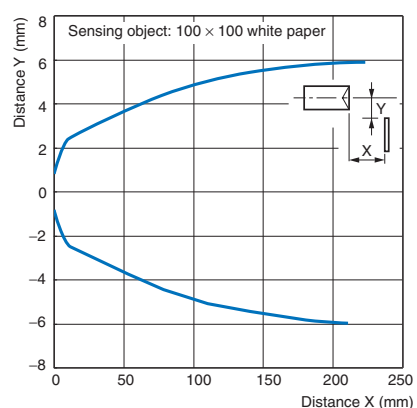



## Excess Gain vs. Distance

### Through-beam Models

#### E3ZM-T□1(T□6)

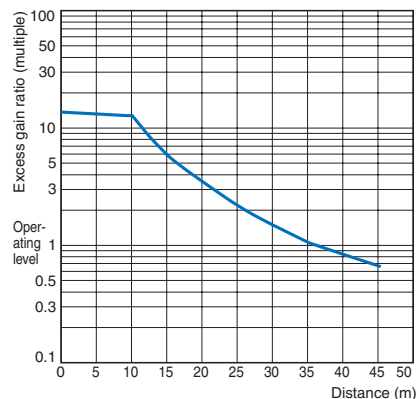

#### E3ZM-T□3(T□8)

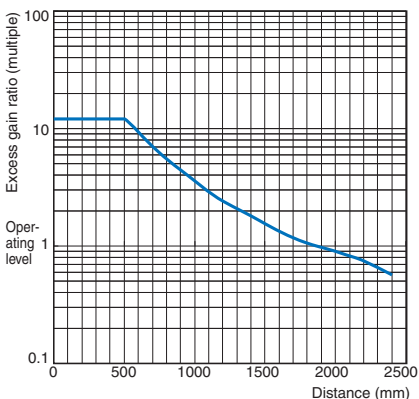

### Retro-reflective Models

#### E3ZM-R□1(R□6)

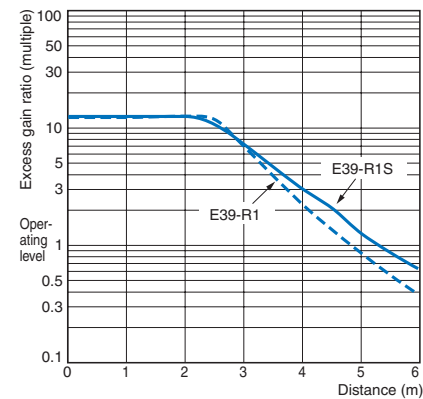

### Diffuse-reflective Models

#### E3ZM-D□2(D□7)

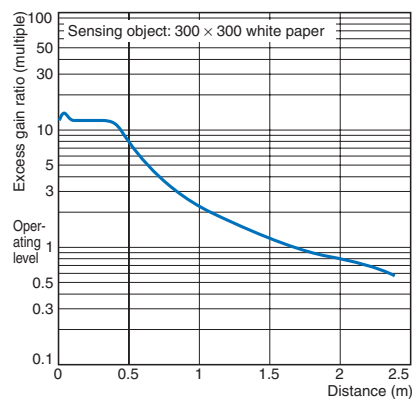

## Sensing Object Size vs. Distance

### Diffuse-reflective Models

#### E3ZM-D□2(D□7)

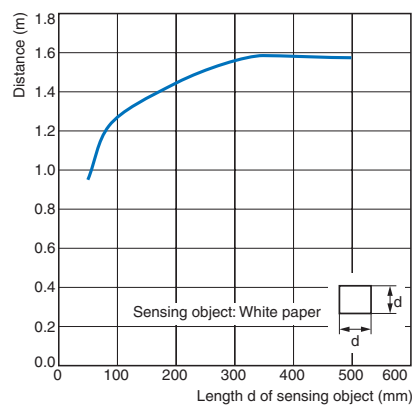

## Spot Diameter vs. Distance

### BGS Reflective Models

#### E3ZM-LS□1H(LS□6H)

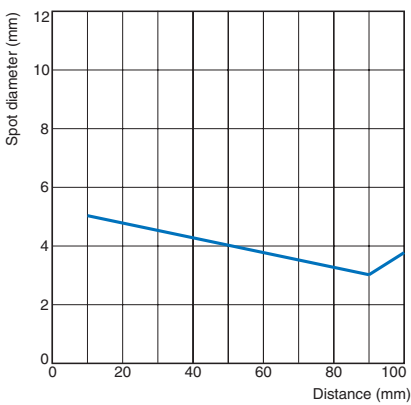

#### E3ZM-LS□2H/LS□4H(LS□7H/LS□9H)

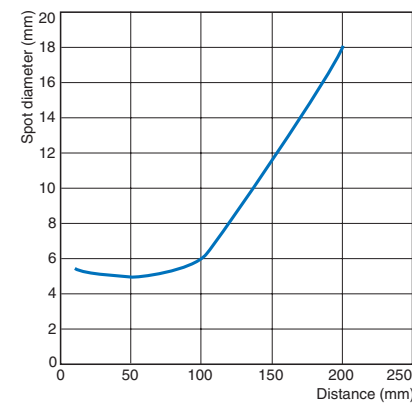



**Sensing Distance vs. Sensing Object Material**

**BGS Reflective Models**

**E3ZM-LS□1H(LS□6H)**

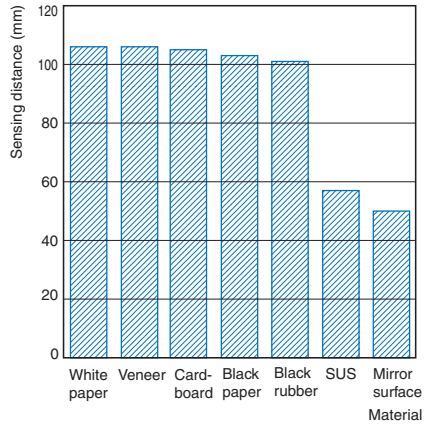

**E3ZM-LS□2H(LS□7H)**

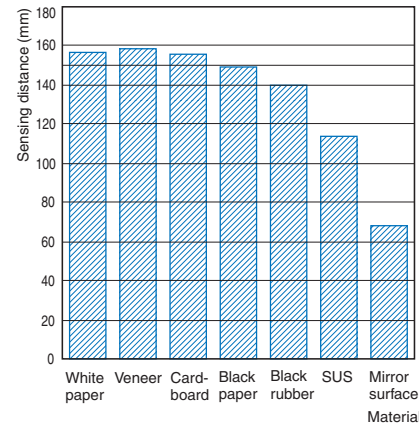

**E3ZM-LS□4H(LS□9H)**

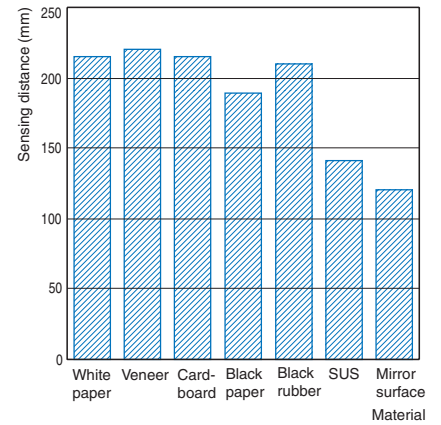

**Inclination Characteristics (Vertical)**

**BGS Reflective Models**

**E3ZM-LS□1H(LS□6H)**

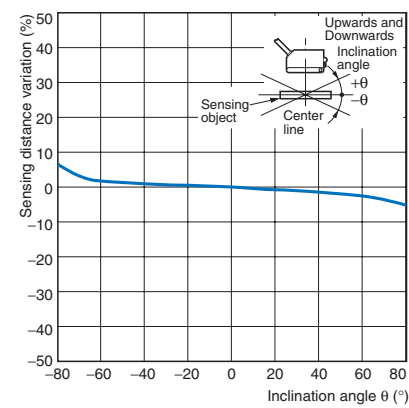

**E3ZM-LS□2H(LS□7H)**

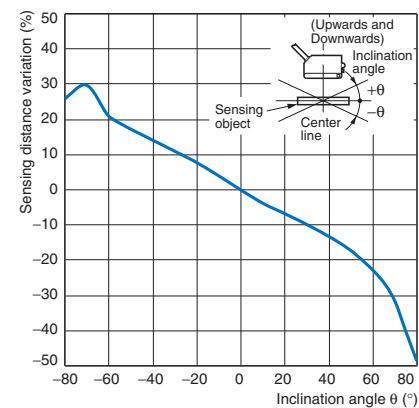

**E3ZM-LS□4H(LS□9H)**

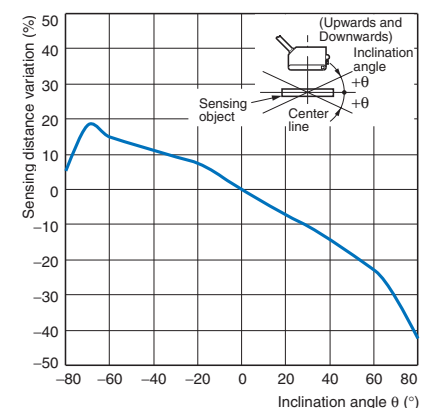

**Inclination Characteristics (Horizontal)**

**BGS Reflective Models**

**E3ZM-LS□1H(LS□6H)**

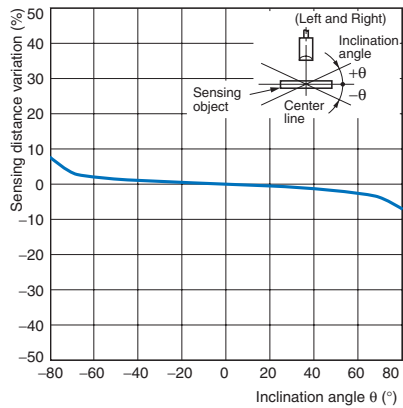

**E3ZM-LS□2H(LS□7H)**

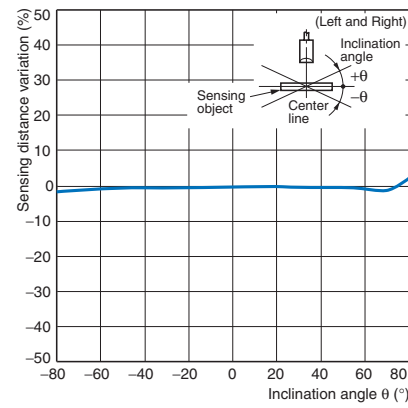

**E3ZM-LS□4H(LS□9H)**

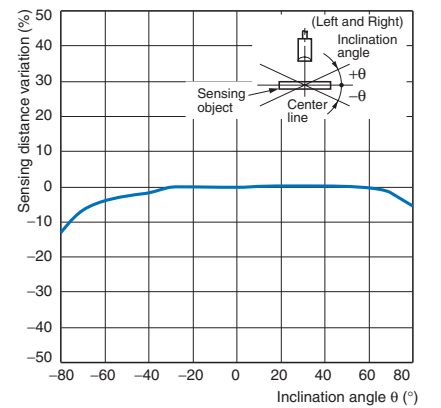

# I/O Circuit Diagrams

## NPN Output

Model	Operation mode	Timing charts	Operation selector	Output circuit
E3ZM-T61* E3ZM-T63* E3ZM-T66* E3ZM-T68* E3ZM-R61 E3ZM-R66 E3ZM-D62 E3ZM-D67	Light-ON		L side (LIGHT ON)	<p>Through-beam Receivers, Retro-reflective Models, Diffuse-reflective Models</p>
	Dark-ON		D side (DARK ON)	
<p>Through-beam Emitter</p>				
E3ZM-LS61H E3ZM-LS66H E3ZM-LS62H E3ZM-LS67H E3ZM-LS64H E3ZM-LS69H	Light-ON		Connect pink lead (2) to brown lead (1).	
	Dark-ON		Connect pink lead (2) to blue lead (3) or leave open.	

\* Models numbers for Through-beam Sensors (E3ZM-T□□) are for sets that include both the Emitter and Receiver. The model number of the Emitter is expressed by adding "L" to the set model number (example: E3ZM-T61-L 2M), the model number of the Receiver, by adding "-D" (example: E3ZM-T61-D 2M.) Refer to Ordering Information to confirm model numbers for Emitter and Receivers.

## PNP Output

Model	Operation mode	Timing charts	Operation selector	Output circuit
E3ZM-T81* E3ZM-T83* E3ZM-T86* E3ZM-T88* E3ZM-R81 E3ZM-R86 E3ZM-D82 E3ZM-D87	Light-ON		L side (LIGHT ON)	<b>Through-beam Receivers, Retro-reflective Models, Diffuse-reflective Models</b> 
	Dark-ON		D side (DARK ON)	
<b>Through-beam Emitter</b> 				
E3ZM-LS81H E3ZM-LS86H E3ZM-LS82H E3ZM-LS87H E3ZM-LS84H E3ZM-LS89H	Light-ON		Connect pink lead (2) to brown lead (1).	
	Dark-ON		Connect pink lead (2) to blue lead (3) or leave open.	

\* Models numbers for Through-beam Sensors (E3ZM-T□□) are for sets that include both the Emitter and Receiver. The model number of the Emitter is expressed by adding "-L" to the set model number (example: E3ZM-T81-L 2M), the model number of the Receiver, by adding "-D" (example: E3ZM-T81-D 2M.) Refer to Ordering Information to confirm model numbers for Emitter and Receivers.

## Connector Pin Arrangement

### M8 Connector (-CN)/M8 Pre-wired Connector

M8 4-pin Connector Pin Arrangement



### Plugs (Sensor I/O Connectors)

#### M8 4-pin Connectors

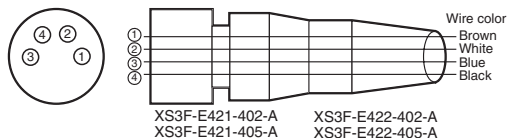

## Nomenclature

### Sensors with Sensitivity Adjustment and Mode Selector Switch

#### Through-beam Models

E3ZM-T□□-D (Receiver)

#### Retro-reflective Models

E3ZM-R□□

#### Diffuse-reflective Models

E3ZM-D□□

### Infinite Adjustment Emitter

#### BGS Reflective Models

E3ZM-LS□□H

#### Through-beam Models

E3ZM-T□□-L (Emitter)

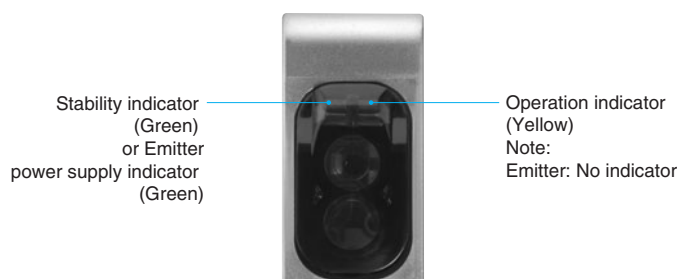

## Safety Precautions

Refer to *Warranty and Limitations of Liability*.

### WARNING

This product is not designed or rated for ensuring safety of persons. Do not use it for such a purpose.



### CAUTION

Do not use the product with voltage in excess of the rated voltage. Excess voltage may result in malfunction or fire.



Never use the product with an AC power supply. Otherwise, explosion may result.



When cleaning the product, do not apply a concentrated spray of water to one part of the product. Otherwise, parts may become damaged and the degree of protection may be degraded.



High-temperature environments may result in burn injury.



### Precautions for Safe Use

The following precautions must be observed to ensure safe operation of the Sensor.

#### Operating Environment

Do not use the Sensor in an environment where explosive or flammable gas is present.

#### Connecting Connectors

Be sure to hold the connector cover when inserting or removing the connector.

If the XS3F is used, always tighten the connector cover by hand. Do not use pliers.

If the tightening is insufficient, the degree of protection will not be maintained and the Sensor may become loose due to vibration. The appropriate tightening torque is 0.3 to 0.4 N·m.

If other commercially available connectors are used, follow the recommended connector application conditions and recommended tightening torque specifications.

#### Load

Do not use a load that exceeds the rated load.

#### Low-temperature Environments

Do not touch the metal surface with your bare hands when the temperature is low. Touching the surface may result in a cold burn.

#### Rotation Torque for Sensitivity Adjustment and Selector Switch

Adjust with a torque of 0.06 N·m or less.

#### Oily Environments

Do not use the Sensor in oily environments.

#### Modifications

Do not attempt to disassemble, repair, or modify the Sensor.

#### Outdoor Use

Do not use the Sensor in locations subject to direct sunlight.

#### Cleaning

Do not use thinner, alcohol, or other organic solvents. Otherwise, the optical properties and degree of protection may be degraded.

#### Washing

Do not use highly concentrated detergents. They may cause malfunction. Do not use high-pressure water spray in excess of the specifications.

#### Surface Temperature

Burn injury may occur. The Sensor surface temperature rises depending on application conditions, such as the surrounding temperature and the power supply voltage. Use caution when operating or washing the Sensor.

## Precautions for Correct Use

### Do not install the Sensor in the following locations.

- (1) Locations subject to direct sunlight
- (2) Locations subject to condensation due to high humidity
- (3) Locations subject to corrosive gas
- (4) Locations where the Sensor may receive direct vibration or shock

### Connecting and Mounting

- (1) The maximum power supply voltage is 30 VDC. Before turning the power ON, make sure that the power supply voltage does not exceed the maximum voltage.
- (2) Laying Sensor wiring in the same conduit or duct as high-voltage wires or power lines may result in malfunction or damage due to induction. As a general rule, wire the Sensor in a separate conduit or use shielded cable.
- (3) Use an extension cable with a minimum thickness of 0.3 mm<sup>2</sup> and less than 100 m long.
- (4) Do not pull on the cable with excessive force.
- (5) Pounding the Photoelectric Sensor with a hammer or other tool during mounting will impair water resistance. Also, use M3 screws.
- (6) Mount the Sensor either using the bracket (sold separately) or on a flat surface.
- (7) Be sure to turn OFF the power supply before inserting or removing the connector.

### Cleaning

Never use thinner or other solvents. Otherwise, the Sensor surface may be dissolved.

### Power Supply

If a commercial switching regulator is used, ground the FG (frame ground) terminal.

### Power Supply Reset Time

The Sensor will be able to detect objects 100 ms after the power supply is turned ON. Start using the Sensor 100 ms or more after turning ON the power supply. If the load and the Sensor are connected to separate power supplies, be sure to turn ON the Sensor first.

### Turning OFF the Power Supply

Output pulses may be generated even when the power supply is OFF. Therefore, it is recommended to first turn OFF the power supply for the load or the load line.

### Load Short-circuit Protection

This Sensor is equipped with load short-circuit protection, but be sure to not short circuit the load. Be sure to not use an output current flow that exceeds the rated current. If a load short circuit occurs, the output will turn OFF, so check the wiring before turning ON the power supply again. The short-circuit protection circuit will be reset. The load short-circuit protection will operate when the current flow reaches 1.8 times the rated load current. When using a C load, use an inrush current of 1.8 times the rated load current or higher.

### Water Resistance

Do not use the Sensor in water, rainfall, or outdoors.

**When disposing of the Sensor, treat it as industrial waste.**

### Mounting Diagram

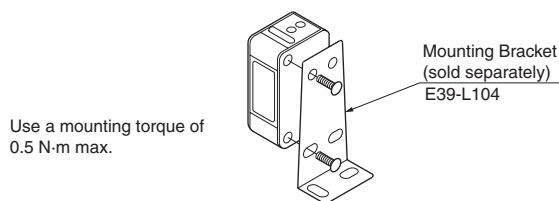

### Resistance to Detergents, Disinfectants, and Chemicals

- Performance is assured for typical detergents and disinfectants, but performance may not be maintained for some detergents and disinfectants. Refer to the following table when using these agents.
- The E3ZM passed testing for resistance to detergents and disinfectants performed using the items in the following table. Refer to this table when considering use of detergents and disinfectants.

Category	Product name	Concentration	Temperature	Time
Chemical	Sodium hydroxide (NaOH)	1.5%	70°C	240h
	Potassium hydroxide (KOH)	1.5%	70°C	240h
	Phosphoric acid (H <sub>3</sub> PO <sub>4</sub> )	2.5%	70°C	240h
	Sodium hypochlorite (NaClO)	0.3%	25°C	240h
	Hydrogen peroxide (H <sub>2</sub> O <sub>2</sub> )	6.5%	25°C	240h
Alkaline foam detergent	P3-topax-66s (Manufactured by Ecolab)	3.0%	70°C	240h
Acidic foam detergent	P3-topax-56 (Manufactured by Ecolab)	5.0%	70°C	240h
Disinfectant	P3-oxonia active 90 (Manufactured by Ecolab)	1.0%	25°C	240h
	TEK121 (Manufactured by ABC Compounding)	1.1%	25°C	240h

Note: The Sensor was immersed in the chemicals, detergents, and disinfectants listed above at the temperatures in the table for 240 hours and then passed an insulation resistance of 100 MΩ min.

## Dimensions

Tolerance class IT16 applies to dimensions in this datasheet unless otherwise specified.

### Sensors

#### Through-beam Models\*

#### Pre-wired Models

- E3ZM-T61
- E3ZM-T81
- E3ZM-T63
- E3ZM-T83



Emitter

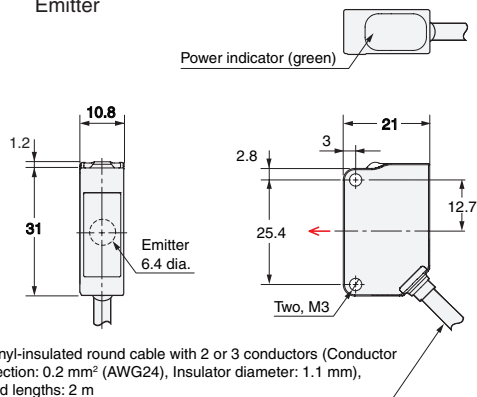

Receiver

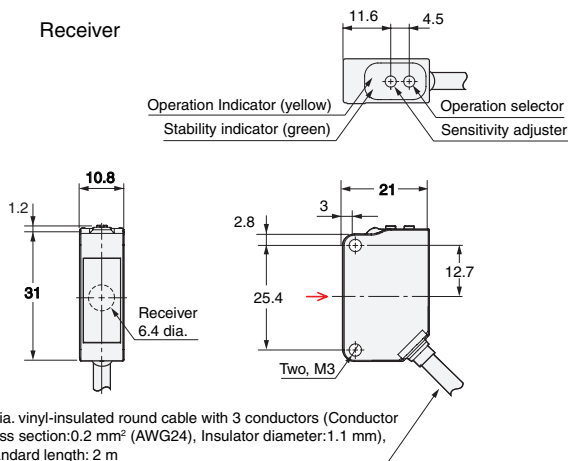

#### Through-beam Models\*

#### Standard Connector

- E3ZM-T66
- E3ZM-T86
- E3ZM-T68
- E3ZM-T88



Emitter

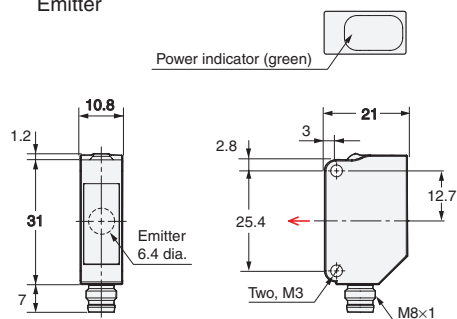

Terminal No.	Specifications
1	+V
2	---
3	0 V
4	---

Receiver

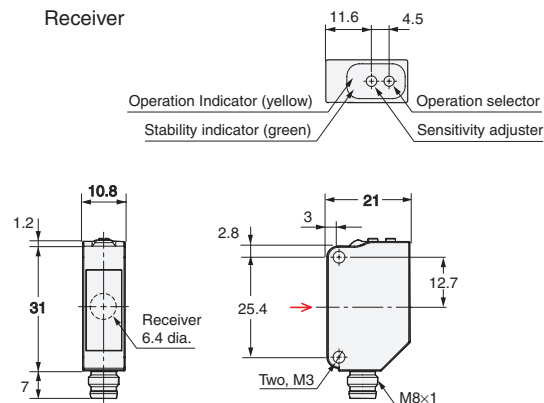

Terminal No.	Specifications
1	+V
2	---
3	0 V
4	Output

\* Models numbers for Through-beam Sensors (E3ZM-T□□) are for sets that include both the Emitter and Receiver. The model number of the Emitter is expressed by adding "-L" to the set model number (example: E3ZM-T61-L 2M), the model number of the Receiver, by adding "-D" (example: E3ZM-T61-D 2M.) Refer to Ordering Information to confirm model numbers for Emitter and Receivers.



## Retro-reflective Models

### Pre-wired Models

E3ZM-R61

E3ZM-R81

## Diffuse-reflective Models

### Standard Connector

E3ZM-D62

E3ZM-D82

## BGS Reflective Models

### Pre-wired Models

E3ZM-LS61H

E3ZM-LS62H

E3ZM-LS64H

E3ZM-LS81H

E3ZM-LS82H

E3ZM-LS84H

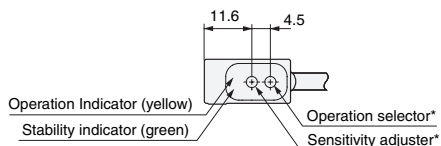

\*No sensitivity adjuster and operation selector with BGS reflective model

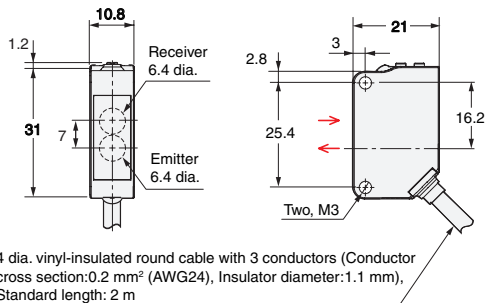

4 dia. vinyl-insulated round cable with 3 conductors (Conductor cross section:0.2 mm<sup>2</sup> (AWG24), Insulator diameter:1.1 mm), Standard length: 2 m

## Retro-reflective Models

### Standard Connector

E3ZM-R66

E3ZM-R86

## Diffuse-reflective Models

### Standard Connector

E3ZM-D67

E3ZM-D87

## BGS Reflective Models

### Standard Connector

E3ZM-LS66H

E3ZM-LS67H

E3ZM-LS69H

E3ZM-LS86H

E3ZM-LS87H

E3ZM-LS89H

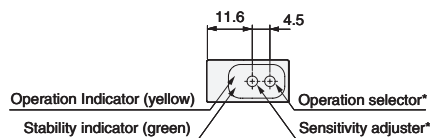

\*No sensitivity adjuster and operation selector with BGS reflective model

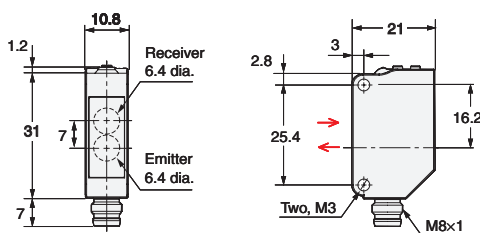

Terminal No.	Specifications
1	+V
2	—
3	0 V
4	Output

## Terms and Conditions Agreement

### Read and understand this catalog.

Please read and understand this catalog before purchasing the products. Please consult your OMRON representative if you have any questions or comments.

### Warranties.

(a) Exclusive Warranty. Omron's exclusive warranty is that the Products will be free from defects in materials and workmanship for a period of twelve months from the date of sale by Omron (or such other period expressed in writing by Omron). Omron disclaims all other warranties, express or implied.

(b) Limitations. OMRON MAKES NO WARRANTY OR REPRESENTATION, EXPRESS OR IMPLIED, ABOUT NON-INFRINGEMENT, MERCHANTABILITY OR FITNESS FOR A PARTICULAR PURPOSE OF THE PRODUCTS. BUYER ACKNOWLEDGES THAT IT ALONE HAS DETERMINED THAT THE PRODUCTS WILL SUITABLY MEET THE REQUIREMENTS OF THEIR INTENDED USE.

Omron further disclaims all warranties and responsibility of any type for claims or expenses based on infringement by the Products or otherwise of any intellectual property right. (c) Buyer Remedy. Omron's sole obligation hereunder shall be, at Omron's election, to (i) replace (in the form originally shipped with Buyer responsible for labor charges for removal or replacement thereof) the non-complying Product, (ii) repair the non-complying Product, or (iii) repay or credit Buyer an amount equal to the purchase price of the non-complying Product; provided that in no event shall Omron be responsible for warranty, repair, indemnity or any other claims or expenses regarding the Products unless Omron's analysis confirms that the Products were properly handled, stored, installed and maintained and not subject to contamination, abuse, misuse or inappropriate modification. Return of any Products by Buyer must be approved in writing by Omron before shipment. Omron Companies shall not be liable for the suitability or unsuitability or the results from the use of Products in combination with any electrical or electronic components, circuits, system assemblies or any other materials or substances or environments. Any advice, recommendations or information given orally or in writing, are not to be construed as an amendment or addition to the above warranty.

See <http://www.omron.com/global/> or contact your Omron representative for published information.

### Limitation on Liability; Etc.

OMRON COMPANIES SHALL NOT BE LIABLE FOR SPECIAL, INDIRECT, INCIDENTAL, OR CONSEQUENTIAL DAMAGES, LOSS OF PROFITS OR PRODUCTION OR COMMERCIAL LOSS IN ANY WAY CONNECTED WITH THE PRODUCTS, WHETHER SUCH CLAIM IS BASED IN CONTRACT, WARRANTY, NEGLIGENCE OR STRICT LIABILITY.

Further, in no event shall liability of Omron Companies exceed the individual price of the Product on which liability is asserted.

### Suitability of Use.

Omron Companies shall not be responsible for conformity with any standards, codes or regulations which apply to the combination of the Product in the Buyer's application or use of the Product. At Buyer's request, Omron will provide applicable third party certification documents identifying ratings and limitations of use which apply to the Product. This information by itself is not sufficient for a complete determination of the suitability of the Product in combination with the end product, machine, system, or other application or use. Buyer shall be solely responsible for determining appropriateness of the particular Product with respect to Buyer's application, product or system. Buyer shall take application responsibility in all cases.

NEVER USE THE PRODUCT FOR AN APPLICATION INVOLVING SERIOUS RISK TO LIFE OR PROPERTY OR IN LARGE QUANTITIES WITHOUT ENSURING THAT THE SYSTEM AS A WHOLE HAS BEEN DESIGNED TO ADDRESS THE RISKS, AND THAT THE OMRON PRODUCT(S) IS PROPERLY RATED AND INSTALLED FOR THE INTENDED USE WITHIN THE OVERALL EQUIPMENT OR SYSTEM.

### Programmable Products.

Omron Companies shall not be responsible for the user's programming of a programmable Product, or any consequence thereof.

### Performance Data.

Data presented in Omron Company websites, catalogs and other materials is provided as a guide for the user in determining suitability and does not constitute a warranty. It may represent the result of Omron's test conditions, and the user must correlate it to actual application requirements. Actual performance is subject to the Omron's Warranty and Limitations of Liability.

### Change in Specifications.

Product specifications and accessories may be changed at any time based on improvements and other reasons. It is our practice to change part numbers when published ratings or features are changed, or when significant construction changes are made. However, some specifications of the Product may be changed without any notice. When in doubt, special part numbers may be assigned to fix or establish key specifications for your application. Please consult with your Omron's representative at any time to confirm actual specifications of purchased Product.

### Errors and Omissions.

Information presented by Omron Companies has been checked and is believed to be accurate; however, no responsibility is assumed for clerical, typographical or proofreading errors or omissions.

2016.6

In the interest of product improvement, specifications are subject to change without notice.

**OMRON Corporation**  
Industrial Automation Company

<http://www.ia.omron.com/>

(c)Copyright OMRON Corporation 2016 All Right Reserved.

# Mouser Electronics

Authorized Distributor

Click to View Pricing, Inventory, Delivery & Lifecycle Information:

Omron:

[E3ZM-D67](#) [E3ZM-D87](#) [E3ZM-LS66H](#) [E3ZM-LS67H](#) [E3ZM-LS69H](#) [E3ZM-LS86H](#) [E3ZM-LS87H](#) [E3ZM-LS89H](#)  
[E3ZM-R66](#) [E3ZM-R86](#)