

SxX8xSx EV Series

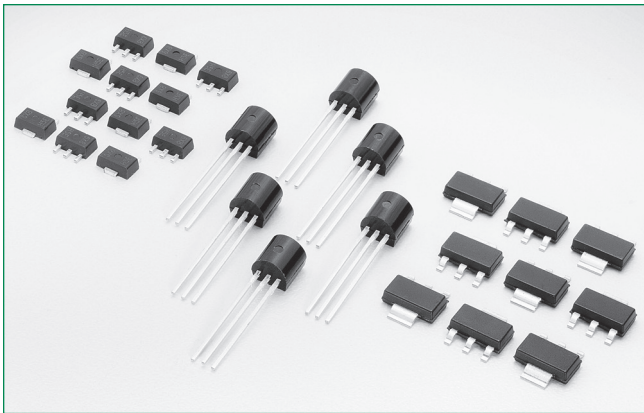

Main Features

Symbol	Value	Unit
$I_{T(RMS)}$	0.8	A
V_{DRM}/V_{RRM}	400, 600, or 800	V
I_{GT}	5 to 450	μ A

Schematic Symbol



Description

This new component series offers high static dv/dt and low turn off time (t_q) sensitive SCR. It is specifically designed for GFCI (Ground Fault Circuit Interrupter) and Gas Ignition applications. All SCRs junctions are glass-passivated to ensure long term reliability and parametric stability.

Features

- RoHS compliant and Halogen-Free
- Through-hole and surface mount packages
- Surge current capability > 10Amps
- Blocking voltage (V_{DRM}/V_{RRM}) capability - up to 800V
- High dv/dt noise immunity
- Improved turn-off time (t_q) < 25 μ sec
- Sensitive gate for direct microprocessor interface

Applications

The SxX8xSx EV series is specifically designed for GFCI (Ground Fault Circuit Interrupter) and gas ignition applications.

Additional Information



Resources



Samples

Absolute Maximum Ratings

Symbol	Parameter	Value	Unit		
$I_{T(RMS)}$	RMS on-state current (full sine wave)	TO-92	$T_c = 55^\circ\text{C}$	0.8	A
		SOT-89	$T_c = 60^\circ\text{C}$	0.8	A
		SOT-223	$T_L = 60^\circ\text{C}$	0.8	A
$I_{T(AV)}$	Average on-state current	TO-92	$T_c = 55^\circ\text{C}$	0.51	A
		SOT-89	$T_c = 60^\circ\text{C}$	0.51	A
		SOT-223	$T_L = 60^\circ\text{C}$	0.51	A
I_{TSM}	Non repetitive surge peak on-state current (Single cycle, $T_{j\text{ initial}} = 25^\circ\text{C}$)	TO-92	F = 50Hz	8	A
		SOT-89 SOT-223	F = 60Hz	10	A
I^2t	I^2t Value for fusing	$t_p = 10$ ms	F = 50 Hz	0.32	A^2s
		$t_p = 8.3$ ms	F = 60 Hz	0.41	A^2s
di/dt	Critical rate of rise of on-state current $I_G = 10\text{mA}$	TO-92 SOT-89 SOT-223	$T_j = 125^\circ\text{C}$	50	$\text{A}/\mu\text{s}$
I_{GM}	Peak Gate Current	$t_p = 10$ μ s	$T_j = 125^\circ\text{C}$	1.0	A
$P_{G(AV)}$	Average gate power dissipation	—	$T_j = 125^\circ\text{C}$	0.1	W
T_{stg}	Storage junction temperature range	—	—	-40 to 150	$^\circ\text{C}$
T_j	Operating junction temperature range	—	—	-40 to 125	$^\circ\text{C}$

Electrical Characteristics ($T_J = 25^\circ\text{C}$, unless otherwise specified)

Symbol	Description	Test Conditions	Limit	Value				Unit
				SxX8yS1	SxX8yS2	SxX8yS	SxX8yS3	
I_{GT}	DC Gate Trigger Current	$V_D = 6V$ $R_L = 100 \Omega$	MIN.	0.5	1	15	70	μA
			MAX.	5	50	200	450	μA
V_{GT}	DC Gate Trigger Voltage	$V_D = 6V$ $R_L = 100 \Omega$	MAX.	0.8				V
V_{GRM}	Peak Reverse Gate Voltage	$I_{RG} = 10\mu\text{A}$	MIN.	5				V
I_H	Holding Current	$R_{GK} = 1 \text{ k}\Omega$ Initial Current = 20mA	MAX.	5			10	mA
(dv/dt)s	Critical Rate-of-Rise of Off-State Voltage	$T_J = 125^\circ\text{C}$ $V_D = V_{DRM} / V_{RRM}$ Exp. Waveform $R_{GK} = 1 \text{ k}\Omega$	MIN.	75			200	V/ μs
V_{GD}	Gate Non-Trigger Voltage	$V_D = V_{DRM}$ $R_{GK} = 1 \text{ k}\Omega$ $T_J = 125^\circ\text{C}$	MIN.	0.2				V
t_q	Turn-Off Time	$T_J = 25^\circ\text{C} @ 600V$ $R_{GK} = 1 \text{ k}\Omega$	MAX.	30	25	25	15	μs
t_{gt}	Turn-On Time	$I_G = 10\text{mA}$ PW = 15 μsec $I_T = 1.6\text{A(pk)}$	TYP.	2.0	2.0	2.0	4	μs

Note: x = voltage/100, y = package

Static Characteristics ($T_J = 25^\circ\text{C}$, unless otherwise specified)

Symbol	Description	Test Conditions	Limit	Value				Unit
				SxX8yS1	SxX8yS2	SxX8yS	SxX8yS3	
V_{TM}	Peak On-State Voltage	$I_{TM} = 1.6\text{A (pk)}$	MAX.	1.7				V
I_{DRM}	Off-State Current, Peak Repetitive	$T_J = 25^\circ\text{C} @ V_D = V_{DRM}$ $R_{GK} = 1 \text{ k}\Omega$	MAX.	3				μA
		$T_J = 125^\circ\text{C} @ V_D = V_{DRM}$ $R_{GK} = 1 \text{ k}\Omega$	MAX.	500			100	μA

Thermal Resistances

Symbol	Description	Test Conditions	Value	Unit	
$R_{\theta JC}$	Junction to case (AC)	$I_T = 0.8\text{A}_{(RMS)}^1$	TO-92	75	$^\circ\text{C/W}$
			SOT-223	30	$^\circ\text{C/W}$
			SOT-89	50	$^\circ\text{C/W}$
$R_{\theta JC}$	Junction to ambient	$I_T = 0.8\text{A}_{(RMS)}^1$	TO-92	150	$^\circ\text{C/W}$
			SOT-223	60	$^\circ\text{C/W}$
			SOT-89	90	$^\circ\text{C/W}$

1 - 60Hz AC resistive load condition, 100% conduction.

Figure 1: Normalized DC Gate Trigger Current For All Quadrants vs. Junction Temperature

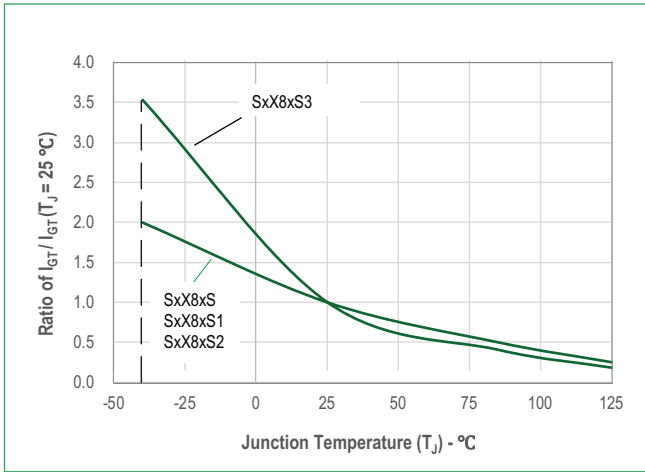

Figure 2: Normalized DC Holding Current vs. Junction Temperature

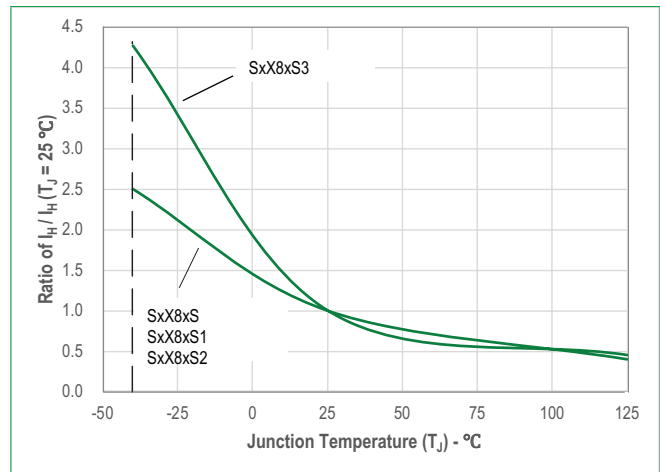

Figure 3: Normalized DC Gate Trigger Voltage vs. Junction Temperature

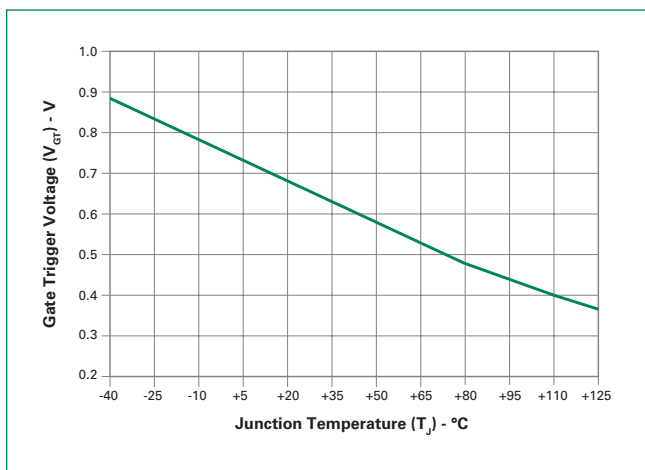

Figure 4: On-State Current vs. On-State Voltage (Typical)

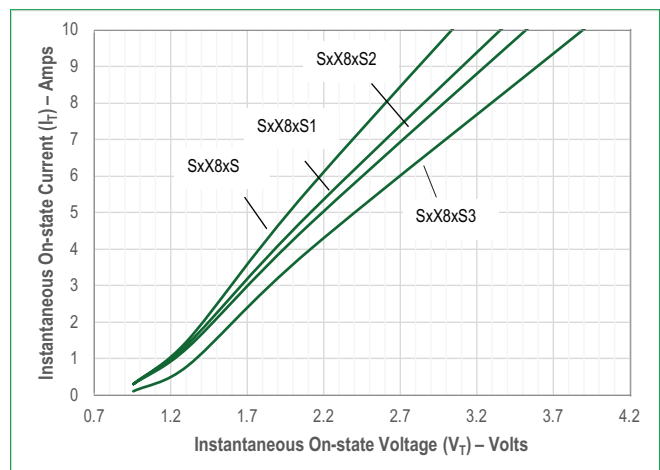

Figure 5: Power Dissipation (Typical) vs. RMS On-State Current

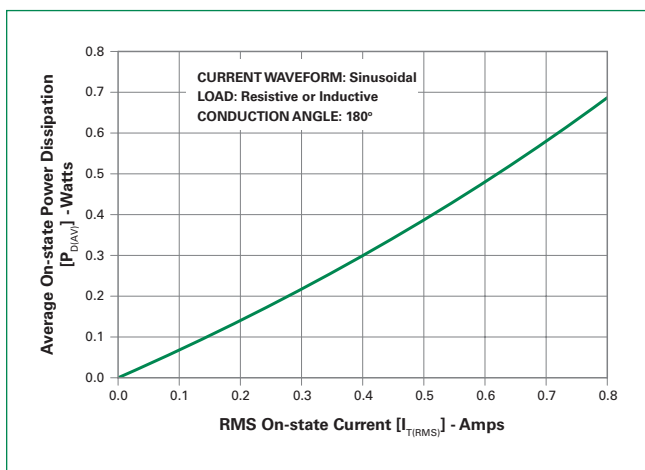

Figure 6: Maximum Allowable Case Temperature vs. On-State Current

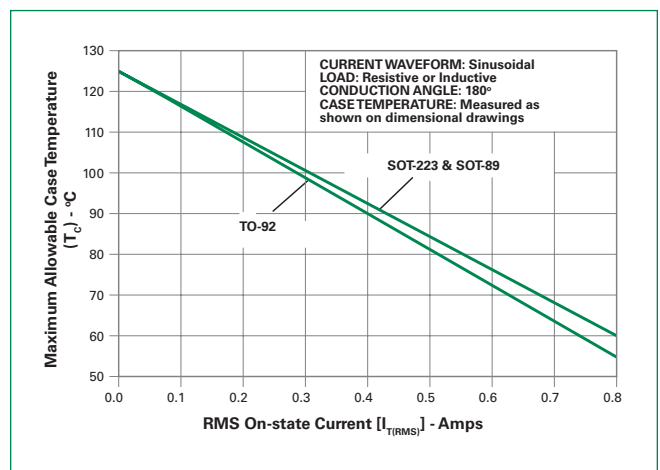

Figure 7-1: Typical DC Gate Trigger Current with R_{GK} vs. Junction Temperature for S6X8xS

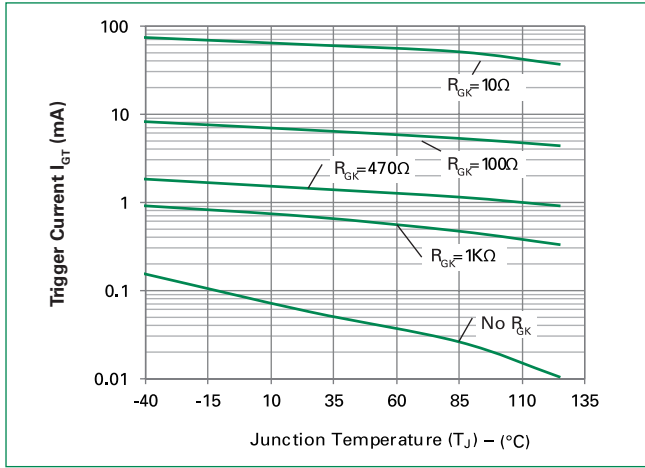

Figure 7-2: Typical DC Gate Trigger Current with R_{GK} vs. Junction Temperature for S8X8xS

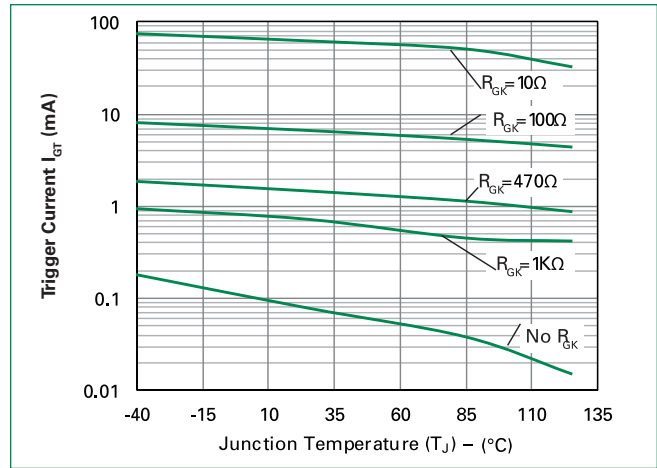

Figure 7-3: Typical DC Gate Trigger Current with R_{GK} vs. Junction Temperature for S6X8xS3

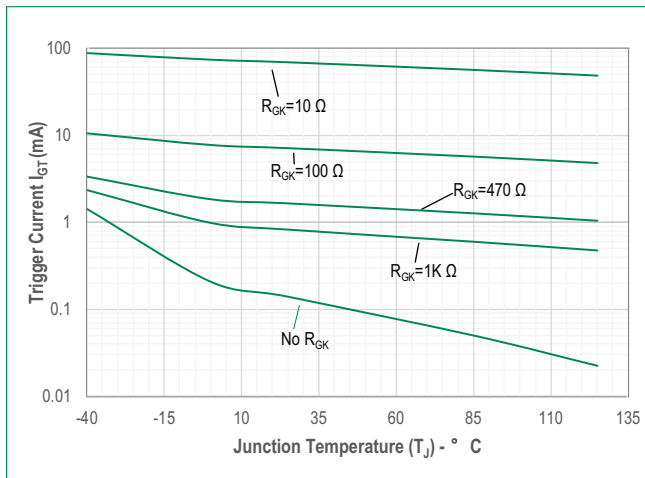

Figure 8-1: Typical DC Holding Current with R_{GK} vs. Junction Temperature for S6X8xS

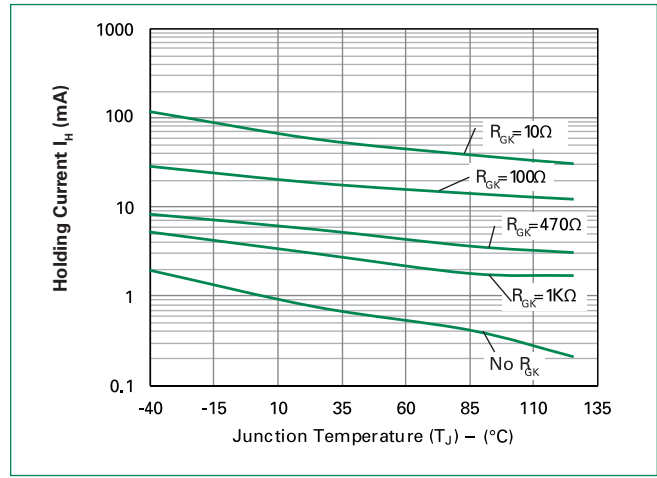

Figure 8-2: Typical DC Holding Current with R_{GK} vs. Junction Temperature for S8X8xS

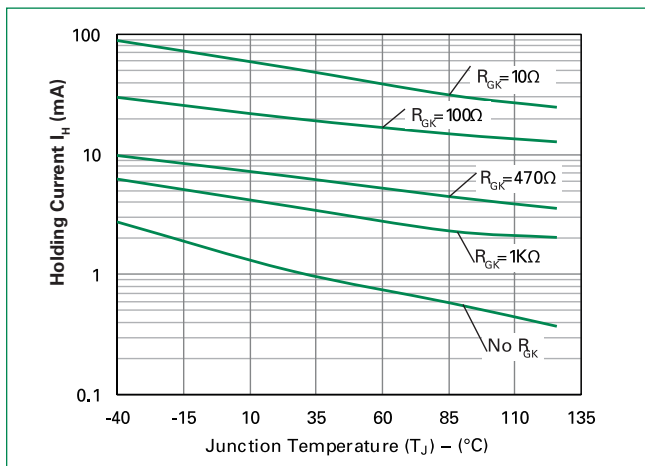

Figure 8-3: Typical DC Holding Current with R_{GK} vs. Junction Temperature for S6X8xS3

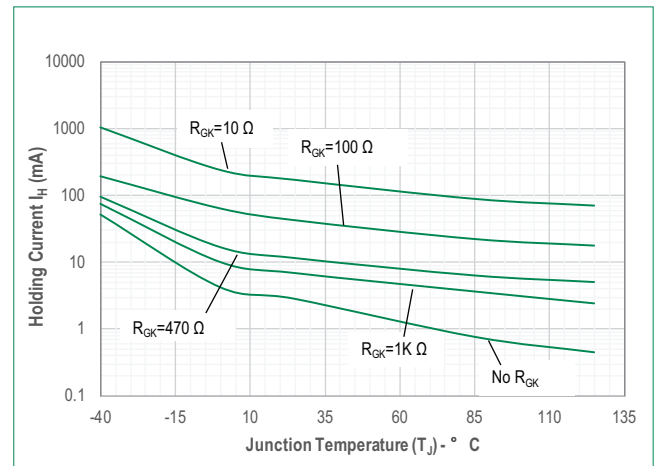

Figure 9-1: Typical DC Static dv/dt with R_{GK} vs. Junction Temperature for S6X8xS

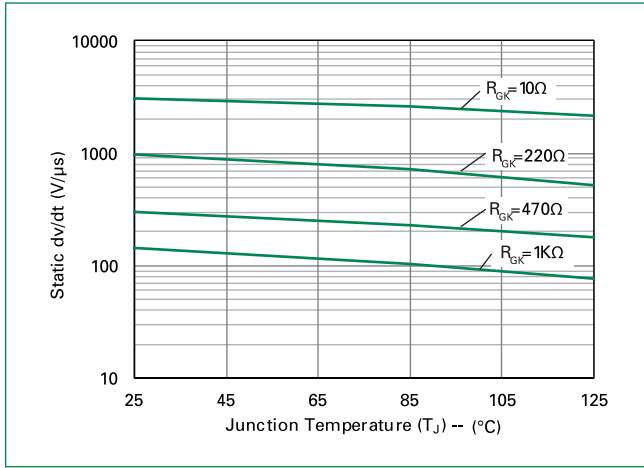

Figure 9-2: Typical DC Static dv/dt with R_{GK} vs. Junction Temperature for S8X8xS

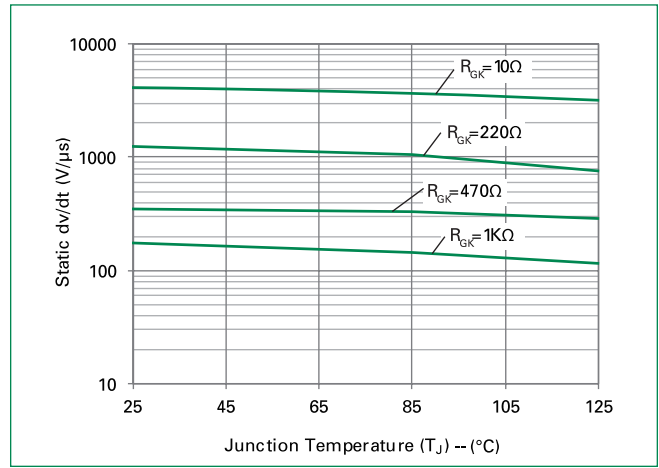

Figure 9-3: Typical DC Static dv/dt with R_{GK} vs. Junction Temperature for S6X8xS3

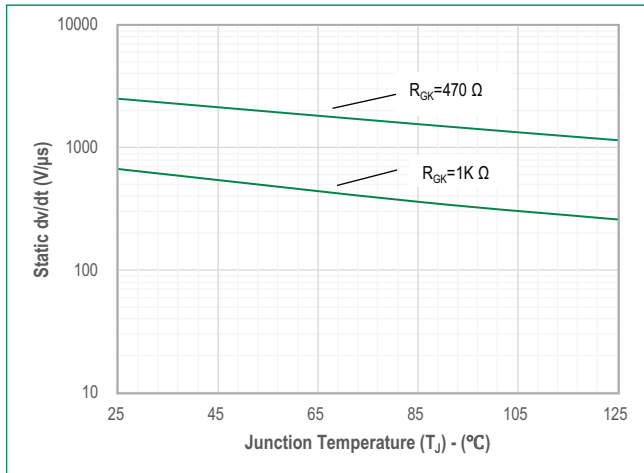

Figure 10-1: Typical DC turn off time with R_{GK} vs. Junction Temperature for S6X8xS

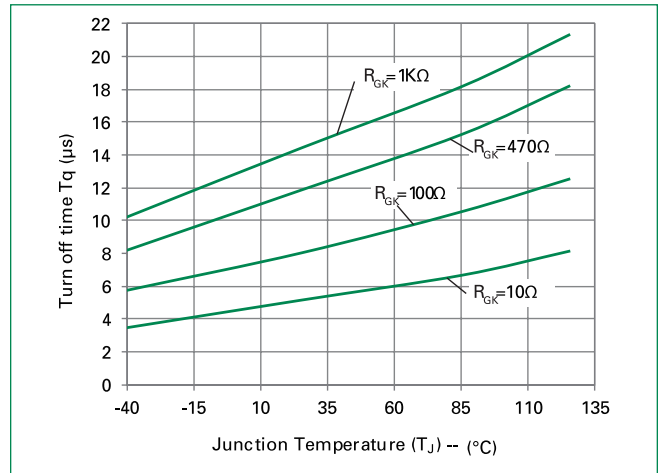

Figure 10-2: Typical DC turn off time with R_{GK} vs. Junction Temperature for S8X8xS

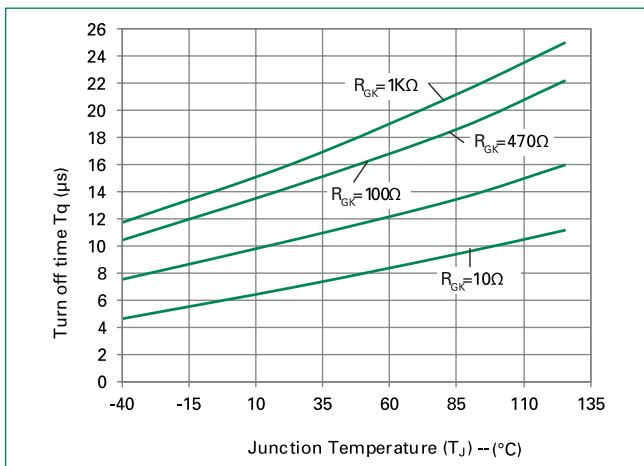

Figure 11: Surge Peak On-State Current vs. Number of Cycles

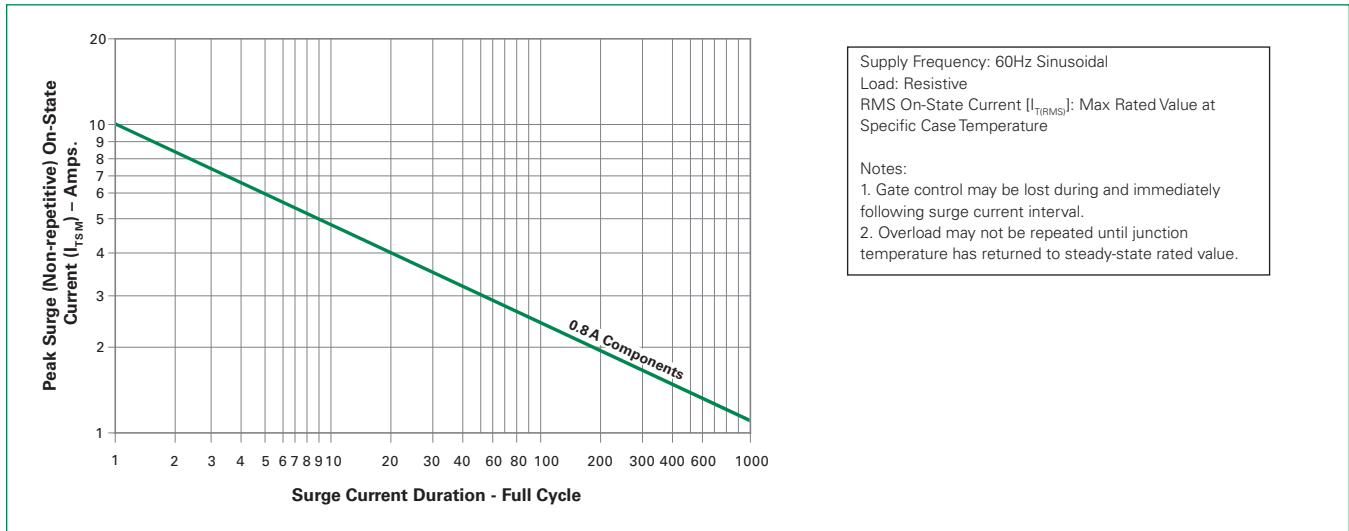
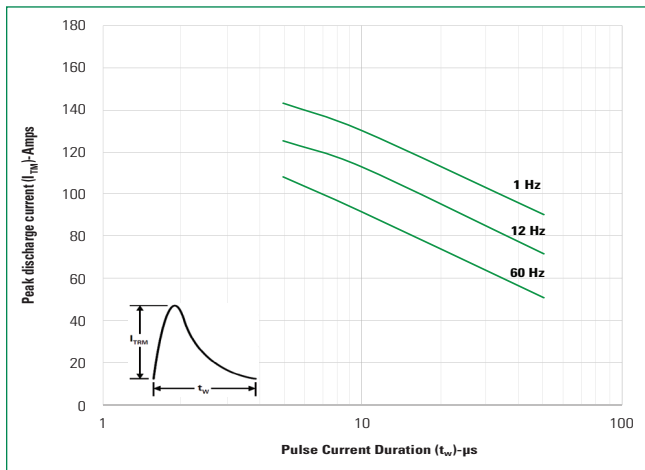
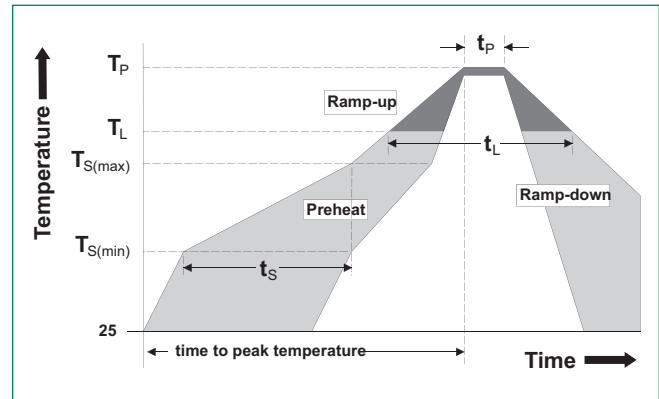

Figure 12: Peak Repetitive Sinusoidal Pulse Current



Soldering Parameters

Reflow Condition		Pb – Free assembly
Pre Heat	- Temperature Min ($T_{s(min)}$)	150°C
	- Temperature Max ($T_{s(max)}$)	200°C
	- Time (min to max) (t_s)	60 – 180 secs
Average ramp up rate (Liquidus Temp) (T_L) to peak		5°C/second max
$T_{s(max)}$ to T_L - Ramp-up Rate		5°C/second max
Reflow	- Temperature (T_L) (Liquidus)	217°C
	- Time (min to max) (t_s)	60 – 150 seconds
Peak Temperature (T_p)		260 ^{+0/-5} °C
Time within 5°C of actual peak Temperature (t_p)		20 – 40 seconds
Ramp-down Rate		5°C/second max
Time 25°C to peak Temperature (T_p)		8 minutes Max.
Do not exceed		280°C



Physical Specifications

Terminal Finish	100% Matte Tin-plated.
Body Material	UL Recognized compound meeting flammability rating V-0
Lead Material	Copper Alloy

Design Considerations

Careful selection of the correct component for the application's operating parameters and environment will go a long way toward extending the operating life of the Thyristor. Good design practice should limit the maximum continuous current through the main terminals to 75% of the component rating. Other ways to ensure long life for a power discrete semiconductor are proper heat sinking and selection of voltage ratings for worst case conditions. Overheating, overvoltage (including dv/dt), and surge currents are the main killers of semiconductors. Correct mounting, soldering, and forming of the leads also help protect against component damage.

Reliability/Environmental Tests

Test	Specifications and Conditions
AC Blocking	MIL-STD-750, M-1040, Cond A Applied Peak AC voltage @ 110°C for 1008 hours
Temperature Cycling	MIL-STD-750, M-1051, 100 cycles; -40°C to +150°C; 15-min dwell-time
Temperature/Humidity	EIA / JEDEC, JESD22-A101 1008 hours; 320V - DC; 85°C; 85% rel humidity
High Temp Storage	MIL-STD-750, M-1031, 1008 hours; 150°C
Low-Temp Storage	1008 hours; -40°C
Resistance to Solder Heat	MIL-STD-750 Method 2031
Solderability	ANSI/J-STD-002, category 3, Test A
Lead Bend	MIL-STD-750, M-2036 Cond E

Dimensions – TO-92

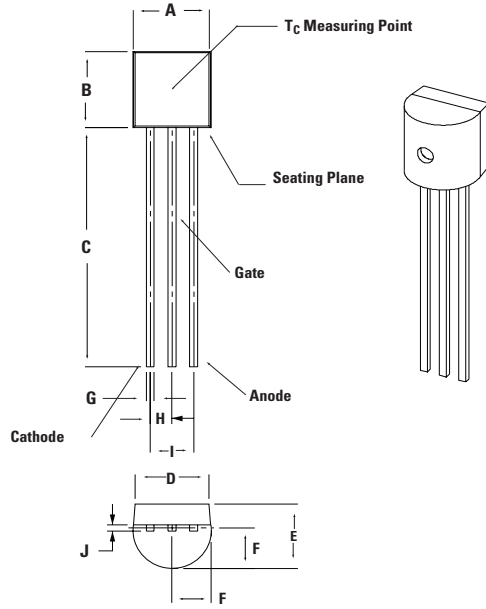

Dimension	Inches		Millimeters	
	Min	Max	Min	Max
A	0.175	0.205	4.450	5.200
B	0.170	0.210	4.320	5.330
C	0.500	-	12.70	-
D	0.135	-	3.430	-
E	0.125	0.165	3.180	4.190
F	0.080	0.105	2.040	2.660
G	0.016	0.021	0.407	0.533
H	0.045	0.055	1.150	1.390
I	0.095	0.105	2.420	2.660
J	0.015	0.020	0.380	0.500

Dimensions – SOT-223

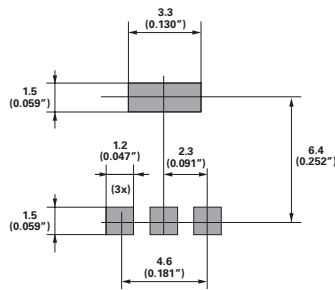
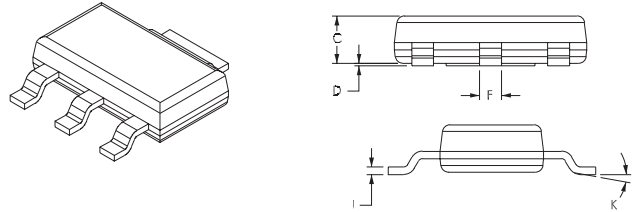
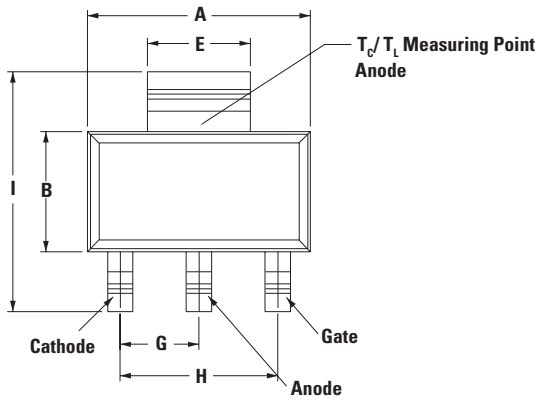

Dimensions in Millimeters (Inches)

Dimensions	Inches			Millimeters		
	Min	Typ	Max	Min	Typ	Max
A	0.248	0.256	0.264	6.30	6.50	6.71
B	0.130	0.138	0.146	3.30	3.50	3.70
C	—	—	0.071	—	—	1.80
D	0.001	—	0.005	0.02	—	0.13
E	0.114	0.118	0.124	2.90	3.00	3.15
F	0.024	0.027	0.034	0.60	0.70	0.85
G	—	0.090	—	—	2.30	—
H	—	0.181	—	—	4.60	—
I	0.264	0.276	0.287	6.70	7.00	7.30
J	0.009	0.010	0.014	0.23	0.26	0.35
K	10° MAX					

Dimensions – SOT-89

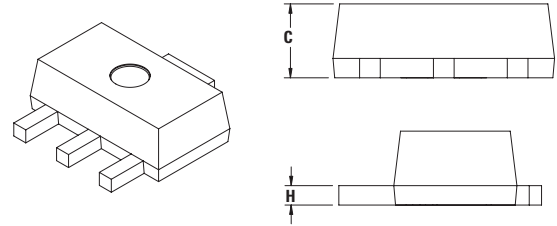
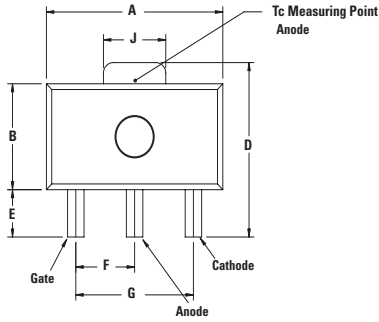

Pad Layout for SOT-89

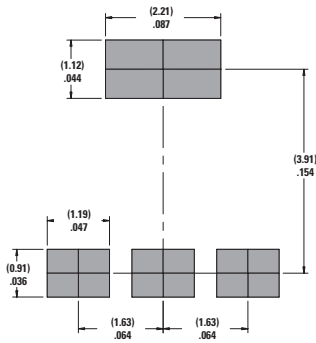

Dimensions in Millimeters (Inches)

Dimension	Inches			Millimeters		
	Min	Typ	Max	Min	Typ	Max
A	0.173	—	0.181	4.40	—	4.60
B	0.090	—	0.102	2.29	—	2.60
C	0.055	—	0.063	1.40	—	1.60
D	0.155	—	0.167	3.94	—	4.25
E	0.035	—	0.047	0.89	—	1.20
F	0.056	—	0.062	1.42	—	1.57
G	0.115	—	0.121	2.92	—	3.07
H	0.014	—	0.017	0.35	—	0.44
I	0.014	—	0.019	0.36	—	0.48
J	0.064	0.067	0.072	1.62	1.69	1.83

Product Selector

Part Numbr	Voltage			Gate Sensitivity	Package
	400V	600V	800V		
SxX8BS	X	X	-	200 μ A	SOT-89
SxX8ES	X	X	X	200 μ A	TO-92
SxX8TS	X	X	X	200 μ A	SOT-223
SxX8BS1	X	X	-	5 μ A	SOT-89
SxX8ES1	X	X	X	5 μ A	TO-92
SxX8TS1	X	X	X	5 μ A	SOT-223
SxX8BS2	X	X	-	50 μ A	SOT-89
SxX8ES2	X	X	X	50 μ A	TO-92
SxX8TS2	X	X	X	50 μ A	SOT-223
SxX8TS3	-	X	-	450 μ A	SOT-223

Packing Options

Part Number	Marking	Weight	Packing Mode	Base Quantity
SxX8ESy	SxX8ESy	0.217g	Bulk	2500
SxX8ESyAP	SxX8ESy	0.217g	Ammo Pack	2000
SxX8ESyRP	SxX8ESy	0.217g	Tape & Reel	2000
SxX8TSyRP	SxX8TSy	0.120g	Tape & Reel	1000
SxX8BSyRP	xX8y	0.053g	Tape & Reel	1000
SxX8BSyRP1	xX8y	0.053g	Tape & Reel	1000

Note: x = voltage/100, y = gate sensitivity

TO-92 (3-lead) Reel Pack (RP) Radial Leaded Specifications

Meets all EIA-468-C Standards

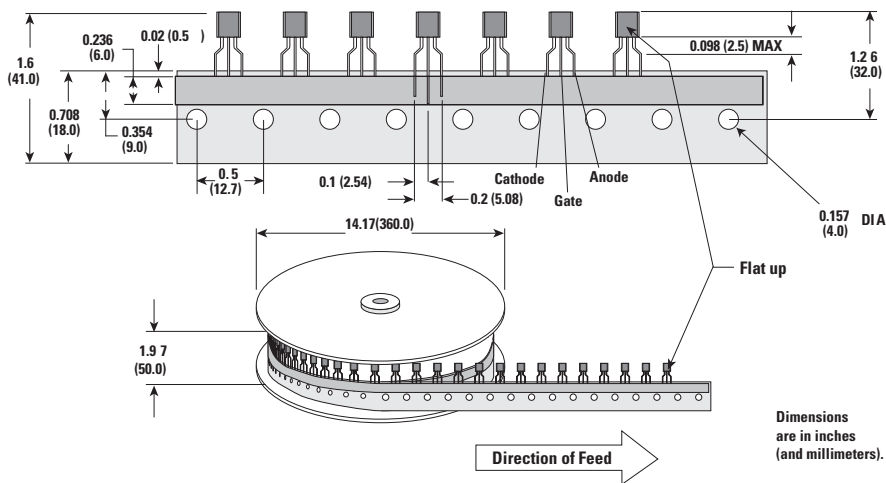

TO-92 (3-lead) Ammo Pack (AP) Radial Leaded Specifications

Meets all EIA-468-C Standards

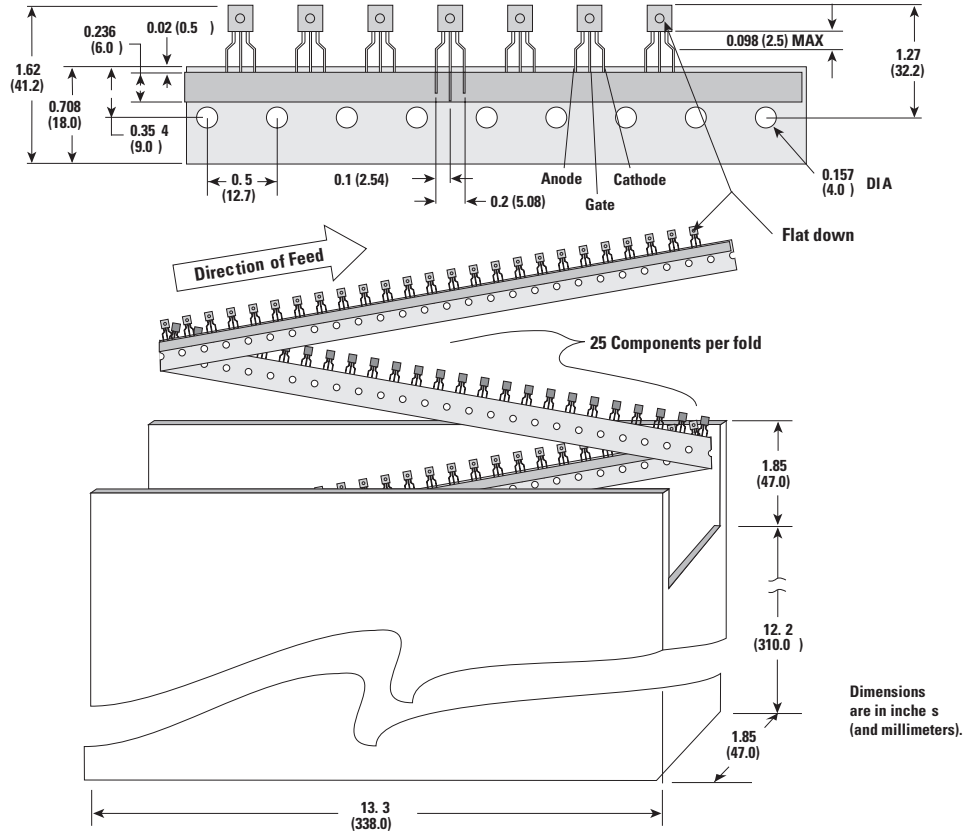

SOT-89 Reel Pack (RP) Specifications

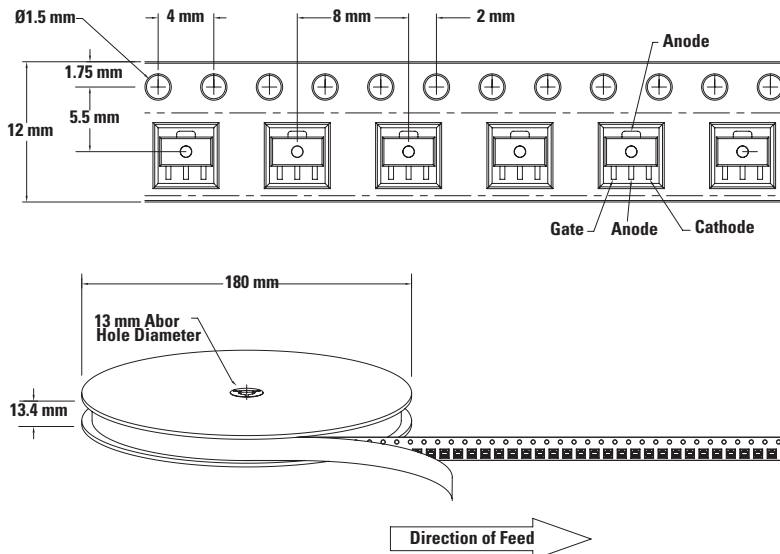

SOT-89 Reel Pack (RP1) Specifications

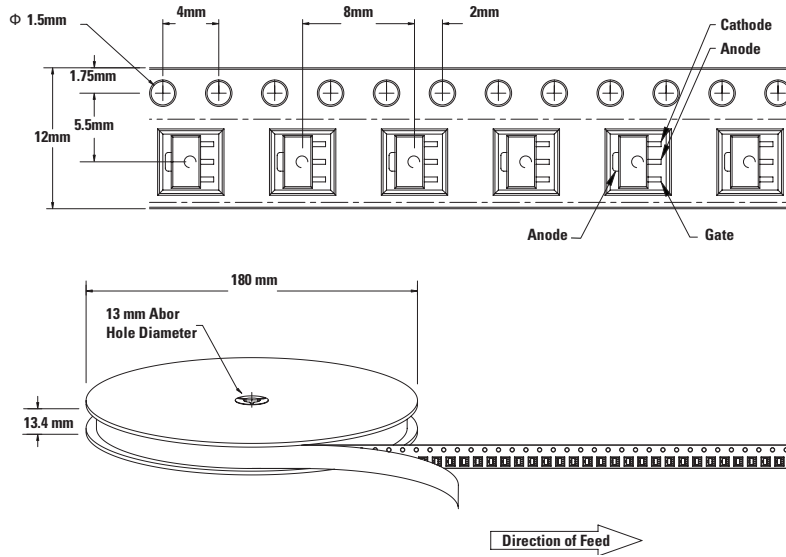

SOT-223 Reel Pack (RP) Specifications

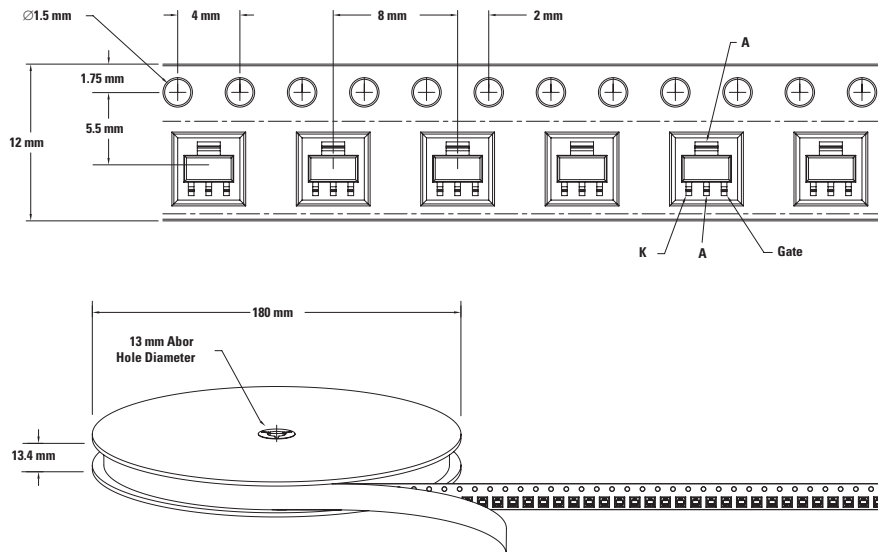

Part Numbering System

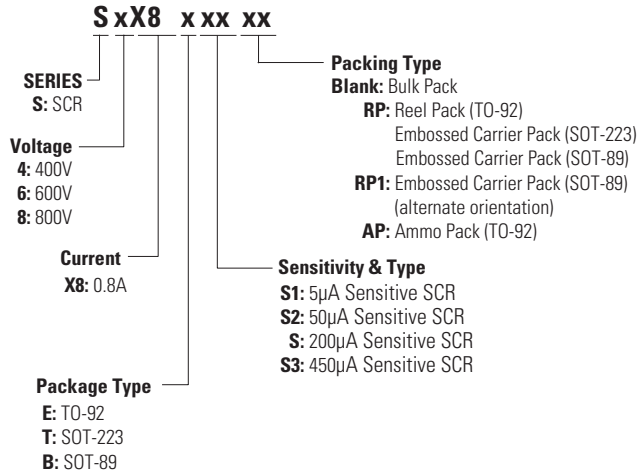

Part Marking System

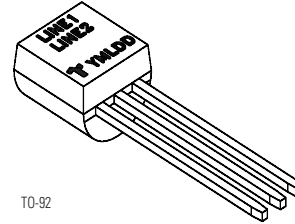
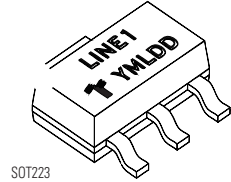
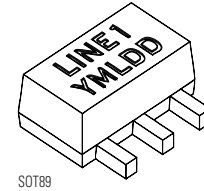

Line1 = Littelfuse Part Number
Line2 = continuation...Littelfuse Part Number
Y = Last Digit of Calendar Year
M = Letter Month Code (A-L for Jan-Dec)
L = Location Code
DD = Calendar Date

Mouser Electronics

Authorized Distributor

Click to View Pricing, Inventory, Delivery & Lifecycle Information:

Littelfuse:

[S4X8ESRP](#) [S6X8ESRP](#) [S6X8ESAP](#) [S4X8ESAP](#) [S4X8ES](#) [S6X8ES](#) [S4X8ES1RP](#) [S4X8ES1](#) [S6X8ES1](#) [S8X8ES](#)
[S4X8BSRP](#) [S4X8ES1AP](#) [S4X8TS1RP](#) [S6X8ES1AP](#) [S8X8ES1](#) [S8X8ES1AP](#) [S8X8ESAP](#) [S4X8ES2](#) [S4X8ES2AP](#)
[S4X8ES2RP](#) [S4X8TS2RP](#) [S6X8ES2](#) [S6X8ES2AP](#) [S8X8ES2](#) [S8X8ES2AP](#) [S6X8TSRP](#) [S4X8TSRP](#) [S6X8BSRP](#)
[S6X8ES1RP](#) [S6X8ES2RP](#) [S6X8TS1RP](#) [S6X8TS2RP](#) [S8X8ESRP](#) [S8X8ES1RP](#) [S8X8ES2RP](#) [S8X8TS1RP](#)
[S8X8TS2RP](#) [S4X8BSRP1](#) [S6X8BS2RP](#) [S6X8BSRP1](#) [S6X8TS3RP](#)