

# Coiltronics DRQ Series

## Dual winding, shielded inductors/transformers



### Product description

- Lead free, RoHS compliant
- 125°C maximum total operating temperature
- Dual winding inductors that can be used as either a single inductor, or in coupled inductor/transformer applications (1:1 turns ratio)
- Four sizes of shielded drum core inductors
- Windings can be connected in series or parallel, offering a broad range of inductance and current ratings
- Peak current ratings from 0.13 to 56 amps
- RMS current ratings from 0.128 to 17.9 amps
- Inductance ratings from 0.33 $\mu$ H to 4.02mH
- Surface mount
- 200Vac Isolation between windings
- Ferrite core material

### Applications

- As a transformer: SEPIC, flyback
- As an inductor: buck, boost, coupled inductor
- DC-DC Converters
- VRM inductor for CPU and DDR power supplies
- Input and output filter chokes

### Environmental data

- Storage temperature range (Component): -40°C to +125°C
- Operating temperature range: -40°C to +125°C (ambient + self-temperature rise)
- Solder reflow temperature: J-STD-020D compliant

### Packaging:

- Supplied in tape and reel packaging (per reel):
  - DRQ73 1350
  - DRQ74 1100
  - DRQ125 600
  - DRQ127 350



The Coiltronics brand of magnetics (formerly of the Bussmann Division of Cooper Industries) is now part of Eaton's Electrical Group, Electronics Division.

**Coiltronics is now part of Eaton**  
**Same great products plus even more.**

Product specifications

Part Number	Rated Inductance (μH)	Parallel Ratings					Series Ratings				
		OCL <sup>1</sup> ±20% (μH)	I <sub>rms</sub> <sup>2</sup> Amps	I <sub>sat</sub> <sup>3</sup> Amps Peak	DCR Ω <sup>4</sup> typ.	Volt <sup>5</sup> μ-Sec	OCL <sup>1</sup> ±20% (μH)	I <sub>rms</sub> <sup>2</sup> Amps	I <sub>sat</sub> <sup>3</sup> Amps Peak	DCR Ω <sup>4</sup> typ.	Volt <sup>5</sup> μ-Sec
DRQ73-R33-R	0.33	0.306	6.19	14.4	0.0074	1.98	1.224	3.10	7.18	0.0296	3.96
DRQ73-1R0-R	1.00	0.992	5.25	7.97	0.0103	3.56	3.968	2.63	3.99	0.0411	7.12
DRQ73-1R5-R	1.50	1.482	4.64	6.52	0.0132	4.36	5.928	2.32	3.26	0.0527	8.72
DRQ73-2R2-R	2.20	2.070	4.11	5.52	0.0167	5.15	8.280	2.06	2.76	0.0669	10.3
DRQ73-3R3-R	3.30	3.540	3.31	4.22	0.0259	6.73	14.16	1.66	2.11	0.1035	13.5
DRQ73-4R7-R	4.70	4.422	3.09	3.78	0.0297	7.52	17.69	1.55	1.89	0.1188	15.0
DRQ73-6R8-R	6.80	6.480	2.55	3.12	0.0435	9.11	25.92	1.28	1.56	0.1742	18.2
DRQ73-8R2-R	8.20	8.930	2.19	2.66	0.0592	10.7	35.72	1.10	1.33	0.2368	21.4
DRQ73-100-R	10.0	10.30	2.08	2.47	0.0656	11.5	41.20	1.04	1.24	0.2623	23.0
DRQ73-150-R	15.0	15.01	1.83	2.05	0.0844	13.9	60.04	0.916	1.03	0.339	27.8
DRQ73-220-R	22.0	22.65	1.62	1.67	0.107	17.0	90.60	0.811	0.83	0.429	34.0
DRQ73-330-R	33.0	34.41	1.31	1.35	0.166	21.0	137.6	0.653	0.68	0.665	42.0
DRQ73-470-R	47.0	48.62	1.08	1.14	0.241	24.9	194.5	0.542	0.57	0.965	49.8
DRQ73-680-R	68.0	68.91	0.89	0.96	0.358	29.7	275.6	0.444	0.48	1.43	59.4
DRQ73-820-R	82.0	80.37	0.86	0.89	0.384	32.1	321.5	0.430	0.44	1.54	64.2
DRQ73-101-R	100	101.4	0.73	0.79	0.527	36.0	405.6	0.367	0.39	2.11	72.0
DRQ73-151-R	150	150.9	0.58	0.65	0.851	44.0	603.6	0.289	0.32	3.41	88.0
DRQ73-221-R	220	223.3	0.52	0.53	1.05	53.5	893.2	0.260	0.27	4.20	107
DRQ73-331-R	330	325.5	0.42	0.44	1.59	64.5	1302	0.211	0.22	6.36	129
DRQ73-471-R	470	465.8	0.35	0.37	2.36	77.2	1863	0.173	0.18	9.44	154
DRQ73-681-R	680	676.5	0.29	0.31	3.47	93.1	2706	0.143	0.15	13.88	186
DRQ73-821-R	820	821.7	0.27	0.28	3.93	103	3287	0.134	0.14	15.72	206
DRQ73-102-R	1000	995.0	0.26	0.25	4.34	113	3980	0.128	0.13	17.36	226

1. Open Circuit Inductance Test Parameters: 100kHz, 0.25 V<sub>rms</sub>, 0.0 Adc  
Parallel: (1,2 -4,3) Series: (1-4) tie (2-3)
2. RMS current for an approximate DT of 40°C without core loss.  
It is recommended that the temperature of the part not exceed 125°C.
3. Peak current for approximately 30% roll-off at 20°C
4. DCR limits @ 20°C
5. Applied Volt-Time product (V-μS) across the inductor. This value represents the applied V-μS at 100kHz necessary to generate a core loss equal to 10% of the total losses for a 40°C temperature rise.

6. Turns Ratio (1:3):(2-4) 1:1
7. Part number definition: DRQxxx-yyy-R  
- DRQxxx = product code and size,  
- yyy = inductance value in μH,  
- R = decimal point. If no R is present, third character = # of zeros  
- "-R" suffix = RoHS compliant

Product specifications

Part Number	Rated Inductance (μH)	Parallel Ratings					Series Ratings				
		OCL <sup>1</sup> ±20% (μH)	I <sub>rms</sub> <sup>2</sup> Amps	I <sub>sat</sub> <sup>3</sup> Amps Peak	DCR Ω <sup>4</sup> Typ.	Volt <sup>5</sup> μ-Sec	OCL <sup>1</sup> ±20% (μH)	I <sub>rms</sub> <sup>2</sup> Amps	I <sub>sat</sub> <sup>3</sup> Amps Peak	DCR Ω <sup>4</sup> Typ.	Volt <sup>5</sup> μ-Sec
DRQ74-R33-R	0.33	0.294	6.20	18.4	0.0074	1.71	1.176	3.10	9.18	0.0295	3.42
DRQ74-1R0-R	1.00	0.952	5.33	10.2	0.0100	3.08	3.808	2.66	5.10	0.0400	6.16
DRQ74-1R5-R	1.50	1.422	4.96	8.35	0.0115	3.76	5.688	2.48	4.17	0.0461	7.52
DRQ74-2R2-R	2.20	1.986	4.66	7.06	0.0130	4.45	7.944	2.33	3.53	0.0521	8.9
DRQ74-3R3-R	3.30	3.396	3.94	5.40	0.0183	5.81	13.58	1.97	2.70	0.0732	11.6
DRQ74-4R7-R	4.70	5.182	3.34	4.37	0.0254	7.18	20.73	1.67	2.19	0.102	14.4
DRQ74-6R8-R	6.80	7.344	2.60	3.67	0.0418	8.55	29.38	1.30	1.84	0.167	17.1
DRQ74-8R2-R	8.20	8.566	2.53	3.40	0.0441	9.23	34.26	1.27	1.70	0.177	18.5
DRQ74-100-R	10.0	9.882	2.41	3.17	0.0489	9.92	39.53	1.20	1.58	0.196	19.8
DRQ74-150-R	15.0	16.09	2.11	2.48	0.0637	12.7	64.36	1.05	1.24	0.255	25.4
DRQ74-220-R	22.0	21.73	1.75	2.13	0.0925	14.7	86.92	0.874	1.07	0.371	29.4
DRQ74-330-R	33.0	33.01	1.41	1.73	0.143	18.1	132.0	0.702	0.87	0.574	36.2
DRQ74-470-R	47.0	49.64	1.15	1.41	0.216	22.2	198.6	0.573	0.71	0.865	44.4
DRQ74-680-R	68.0	69.67	1.03	1.19	0.265	26.3	278.7	0.517	0.60	1.06	52.6
DRQ74-820-R	82.0	80.95	0.91	1.11	0.345	28.4	323.8	0.453	0.55	1.38	56.8
DRQ74-101-R	100	101.6	0.86	0.99	0.383	31.8	406.4	0.430	0.49	1.53	63.6
DRQ74-151-R	150	150.0	0.69	0.81	0.591	38.6	600.0	0.346	0.41	2.37	77.2
DRQ74-221-R	220	227.0	0.56	0.66	0.907	47.5	908.0	0.279	0.33	3.63	95
DRQ74-331-R	330	335.6	0.45	0.54	1.41	57.8	1342	0.224	0.27	5.66	116
DRQ74-471-R	470	465.3	0.40	0.46	1.74	68.1	1861	0.202	0.23	6.97	136
DRQ74-681-R	680	671.2	0.33	0.38	2.58	81.7	2685	0.166	0.19	10.3	163
DRQ74-821-R	820	812.7	0.31	0.35	2.93	89.9	3251	0.156	0.17	11.7	180
DRQ74-102-R	1000	1009	0.27	0.31	3.89	100	4036	0.135	0.16	15.6	200

1. Open Circuit Inductance Test Parameters: 100kHz, 0.25 V<sub>rms</sub>, 0.0 Adc  
Parallel: (1,2 -4,3) Series: (1-4) tie (2-3)
2. RMS current for an approximate DT of 40°C without core loss.  
It is recommended that the temperature of the part not exceed 125°C.
3. Peak current for approximately 30% roll-off at 20°C
4. DCR limits @ 20°C
5. Applied Volt-Time product (V-μS) across the inductor. This value represents the applied V-μS at 100KHz necessary to generate a core loss equal to 10% of the total losses for a 40°C temperature rise.

6. Turns Ratio (1:3):(2-4) 1:1
7. Part number definition: DRQxxx-yyy-R  
- DRQxxx = product code and size,  
- yyy = inductance value in μH,  
- R = decimal point. If no R is present, third character = # of zeros  
- "-R" suffix = RoHS compliant

Product specifications

Part Number	Rated Inductance (μH)	Parallel Ratings					Series Ratings				
		OCL <sup>1</sup> ±20% (μH)	I <sub>rms</sub> <sup>2</sup> Amps	I <sub>sat</sub> <sup>3</sup> Amps Peak	DCR Ω <sup>4</sup> typ.	Volt <sup>5</sup> μ-Sec	OCL <sup>1</sup> ±20% (μH)	I <sub>rms</sub> <sup>2</sup> Amps	I <sub>sat</sub> <sup>3</sup> Amps Peak	DCR Ω <sup>4</sup> typ.	Volt <sup>5</sup> μ-Sec
DRQ125-R47-R	0.47	0.456	17.6	33.0	0.0018	3.17	1.824	8.80	16.5	0.0078	6.34
DRQ125-1R0-R	1.00	0.894	15.0	23.6	0.0024	4.43	3.576	7.51	11.8	0.0096	8.86
DRQ125-1R5-R	1.50	1.478	13.8	18.3	0.0029	5.70	5.912	6.89	9.15	0.0114	11.40
DRQ125-2R2-R	2.20	2.208	10.9	15.0	0.0045	6.97	8.832	5.46	7.50	0.0182	13.9
DRQ125-3R3-R	3.30	3.084	9.26	12.7	0.0063	8.23	12.34	4.63	6.35	0.0253	16.5
DRQ125-4R7-R	4.70	5.274	7.18	9.71	0.0105	10.8	21.10	3.59	4.86	0.0420	21.6
DRQ125-6R8-R	6.80	6.588	6.64	8.68	0.0123	12.0	26.35	3.32	4.34	0.0492	24.0
DRQ125-8R2-R	8.20	8.048	5.54	7.86	0.0176	13.3	32.19	2.77	3.93	0.0705	26.6
DRQ125-100-R	10.0	9.654	5.35	7.17	0.0189	14.6	38.62	2.67	3.59	0.0757	29.2
DRQ125-150-R	15.0	15.35	4.27	5.69	0.0298	18.4	61.40	2.13	2.85	0.120	36.8
DRQ125-220-R	22.0	22.36	3.70	4.71	0.0396	22.2	89.44	1.84	2.36	0.159	44.4
DRQ125-330-R	33.0	33.74	3.28	3.84	0.0505	27.2	135.0	1.64	1.92	0.203	54.4
DRQ125-470-R	47.0	47.47	2.71	3.24	0.0740	32.3	189.9	1.35	1.62	0.297	64.6
DRQ125-680-R	68.0	67.91	2.22	2.70	0.101	38.6	271.6	1.11	1.35	0.440	77.2
DRQ125-820-R	82.0	86.89	2.05	2.39	0.128	43.7	347.6	1.03	1.20	0.515	87.4
DRQ125-101-R	100	102.7	1.78	2.20	0.170	47.5	410.8	0.892	1.10	0.682	95.0
DRQ125-151-R	150	151.1	1.48	1.81	0.248	57.6	604.4	0.739	0.905	0.991	115.2
DRQ125-221-R	220	216.8	1.19	1.51	0.384	69.0	867.2	0.594	0.755	1.54	138
DRQ125-331-R	330	332.6	1.06	1.22	0.482	85.5	1330	0.530	0.610	1.93	171
DRQ125-471-R	470	473.1	0.87	1.02	0.718	102	1892	0.434	0.510	2.87	204
DRQ125-681-R	680	679.8	0.70	0.85	1.10	122	2719	0.350	0.425	4.42	244
DRQ125-821-R	820	828.0	0.60	0.77	1.49	135	3312	0.301	0.385	5.96	270
DRQ125-102-R	1000	1008	0.57	0.70	1.69	149	4032	0.283	0.350	6.76	298

- Open Circuit Inductance Test Parameters: 100kHz, 0.25 V<sub>rms</sub>, 0.0 Adc  
Parallel: (1,2 -4,3) Series: (1-4) tie (2-3)
- RMS current for an approximate DT of 40°C without core loss.  
It is recommended that the temperature of the part not exceed 125°C.
- Peak current for approximately 30% roll-off at 20°C
- DCR limits @ 20°C
- Applied Volt-Time product (V-μS) across the inductor. This value represents the applied V-μS at 100kHz necessary to generate a core loss equal to 10% of the total losses for a 40°C temperature rise.

- Turns Ratio (1:3):(2-4) 1:1
- Part number definition: DRQxxx-yyy-R  
- DRQxxx = product code and size,  
- yyy = inductance value in μH,  
- R = decimal point. If no R is present, third character = # of zeros  
- "-R" suffix = RoHS compliant

Product specifications

Part Number	Rated Inductance (μH)	Parallel Ratings					Series Ratings				
		OCL <sup>1</sup> ±20% (μH)	I <sub>rms</sub> <sup>2</sup> Amps	I <sub>sat</sub> <sup>3</sup> Amps Peak	DCR Ω <sup>4</sup> typ.	Volt <sup>5</sup> μ-Sec	OCL <sup>1</sup> ±20% (μH)	I <sub>rms</sub> <sup>2</sup> Amps	I <sub>sat</sub> <sup>3</sup> Amps Peak	DCR Ω <sup>4</sup> typ.	Volt <sup>5</sup> μ-Sec
DRQ127-R47-R	0.47	0.419	17.9	56.0	0.00195	3.50	1.676	8.94	28	0.0078	7.00
DRQ127-1R0-R	1.00	0.821	15.5	40.0	0.00261	4.90	3.284	7.74	20	0.0104	9.80
DRQ127-1R5-R	1.50	1.357	13.5	31.1	0.00341	6.30	5.428	6.77	15.6	0.0137	12.60
DRQ127-2R2-R	2.20	2.027	12.5	25.5	0.00373	7.70	8.108	6.23	12.7	0.0161	15.4
DRQ127-3R3-R	3.30	2.831	10.4	21.5	0.00567	9.10	11.32	5.23	10.8	0.0229	18.2
DRQ127-4R7-R	4.70	4.841	8.25	16.5	0.00917	11.9	19.36	4.13	8.24	0.0367	23.8
DRQ127-6R8-R	6.80	7.387	7.34	13.3	0.0116	14.7	29.55	3.67	6.67	0.0465	29.4
DRQ127-8R2-R	8.20	8.861	6.32	12.2	0.0157	16.1	35.44	3.16	6.09	0.0627	32.2
DRQ127-100-R	10.0	10.47	6.04	11.2	0.0172	17.5	41.88	3.02	5.60	0.0686	35.0
DRQ127-150-R	15.0	14.09	5.03	9.66	0.0247	20.3	56.36	2.51	4.83	0.0990	40.6
DRQ127-220-R	22.0	22.93	4.00	7.57	0.0391	25.9	91.72	2.00	3.78	0.157	51.8
DRQ127-330-R	33.0	33.92	3.23	6.22	0.0600	31.5	135.7	1.61	3.11	0.241	63.0
DRQ127-470-R	47.0	47.05	2.95	5.28	0.0719	37.1	188.2	1.47	2.64	0.288	74.2
DRQ127-680-R	68.0	66.48	2.44	4.44	0.105	44.1	265.9	1.22	2.22	0.421	88.2
DRQ127-820-R	82.0	79.75	2.09	4.06	0.143	48.3	319.0	1.04	2.03	0.573	96.6
DRQ127-101-R	100	99.31	1.96	3.64	0.163	53.9	397.2	0.980	1.82	0.653	107.8
DRQ127-151-R	150	144.9	1.59	3.01	0.247	65.1	579.6	0.796	1.51	0.989	130.2
DRQ127-221-R	220	221.5	1.29	2.43	0.376	80.5	886.0	0.645	1.22	1.50	161
DRQ127-331-R	330	323.6	1.04	2.01	0.574	97.3	1294	0.522	1.01	2.30	195
DRQ127-471-R	470	467.1	0.85	1.68	0.861	117	1868	0.427	0.838	3.44	234
DRQ127-681-R	680	676.7	0.76	1.39	1.08	141	2707	0.380	0.697	4.32	282
DRQ127-821-R	820	818.1	0.65	1.27	1.47	155	3272	0.325	0.633	5.88	310
DRQ127-102-R	1000	1005	0.61	1.14	1.66	172	4020	0.307	0.571	6.64	344

- Open Circuit Inductance Test Parameters: 100kHz, 0.25 V<sub>rms</sub>, 0.0 Adc  
Parallel: (1,2 -4,3) Series: (1-4) tie (2-3)
- RMS current for an approximate DT of 40°C without core loss.  
It is recommended that the temperature of the part not exceed 125°C.
- Peak current for approximately 30% roll-off at 20°C
- DCR limits @ 20°C
- Applied Volt-Time product (V-μS) across the inductor. This value represents the applied V-μS at 100KHz necessary to generate a core loss equal to 10% of the total losses for a 40°C temperature rise.

- Turns Ratio (1:3):(2-4) 1:1
- Part number definition: DRQxxx-yyy-R  
- DRQxxx = product code and size,  
- yyy = inductance value in μH,  
- R = decimal point. If no R is present, third character = # of zeros  
- "-R" suffix = RoHS compliant

Dimensions - mm

DRQ73 Series

Top View



Side View

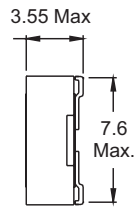

Recommended Pad Layout

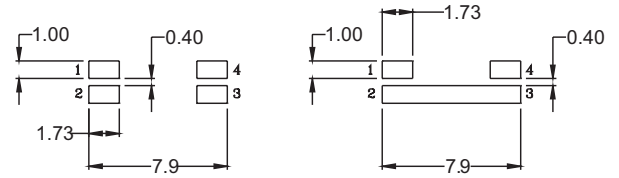

Dual Inductor Mode

Series Mode

Bottom View

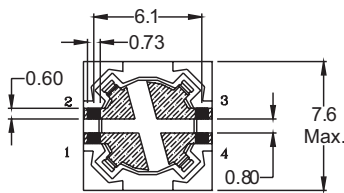

Schematic

Dual Inductor

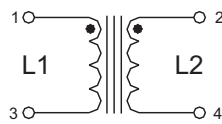

Series Mode

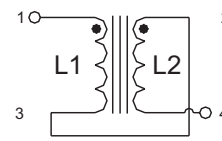

Parallel Mode

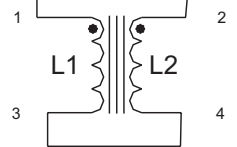

DRQ74 Series

Top View



Side View

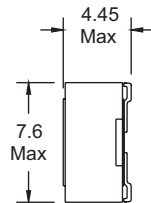

Recommended Pad Layout

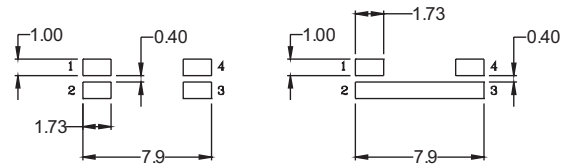

Dual Inductor Mode

Series Mode

Bottom View

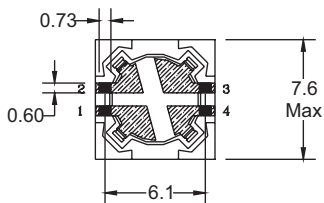

Schematic

Dual Inductor

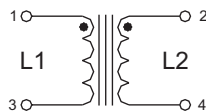

Series Mode

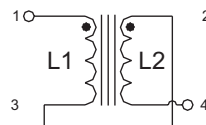

Parallel Mode

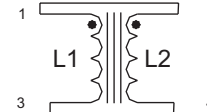

### = Inductance value per family chart  
wlyy = Date code  
R = Revision level  
Dot indicates pin #1

Dimensions - mm

DRQ125 Series

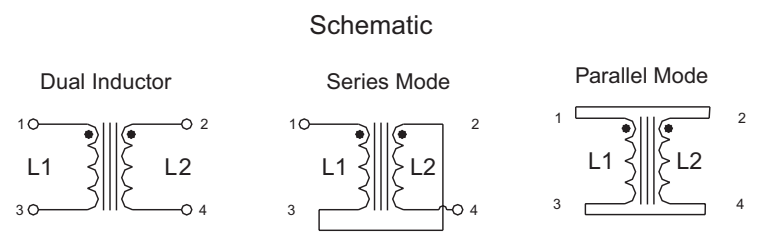
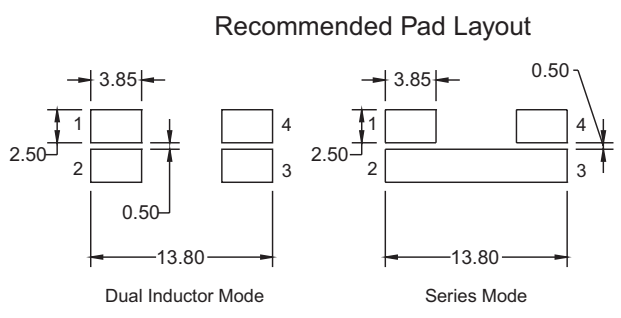
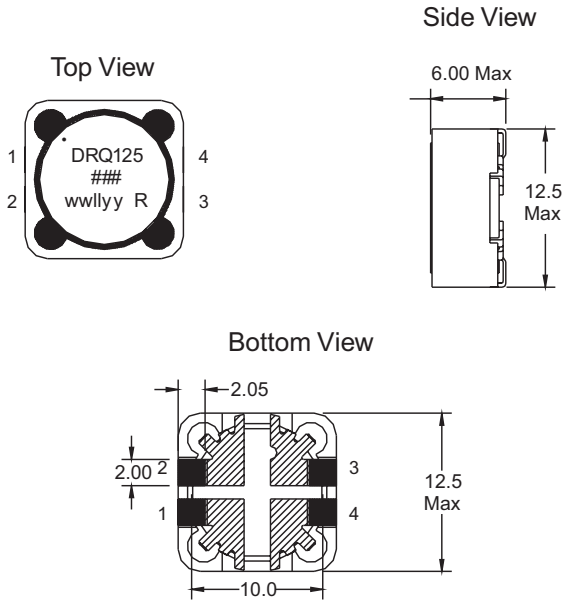

DRQ127 Series

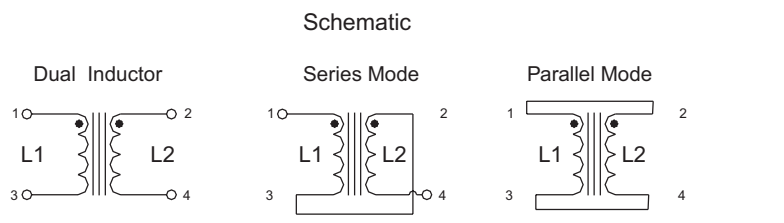
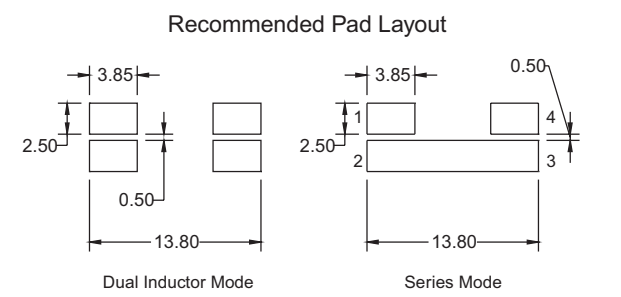
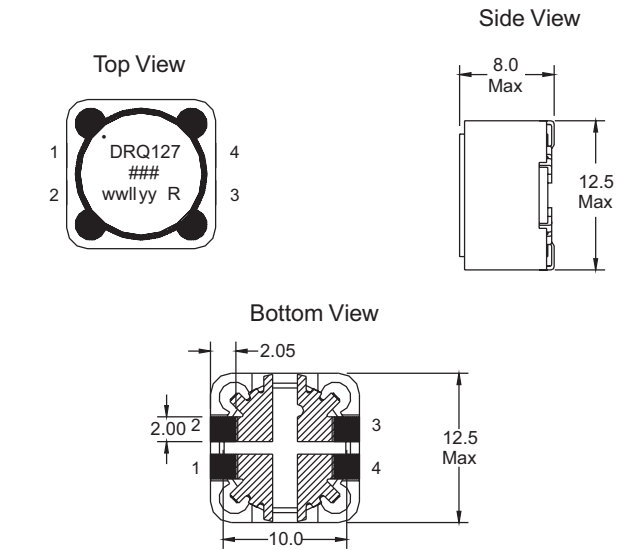

Dimensions in millimeters.

### = Inductance value per family chart  
wwlly = (date code) R = revision level  
Dot indicates pin #1

**Packaging information - mm**

**DRQ73 Series**

Supplied in tape and reel packaging,  
1350 parts per reel, 13" diameter reel.

Ao=7.90mm  
Bo=7.90mm  
Ko=3.80mm

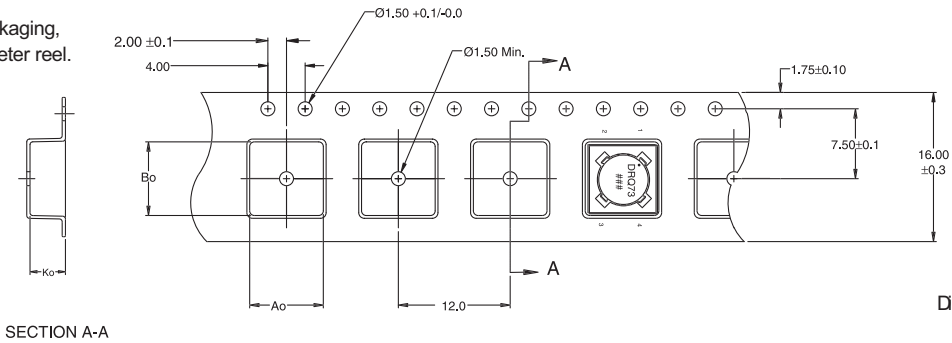

**DRQ74 Series**

Supplied in tape and reel packaging,  
1100 parts per reel, 13" diameter reel.

Ao=7.90mm  
Bo=7.90mm  
Ko=4.70mm

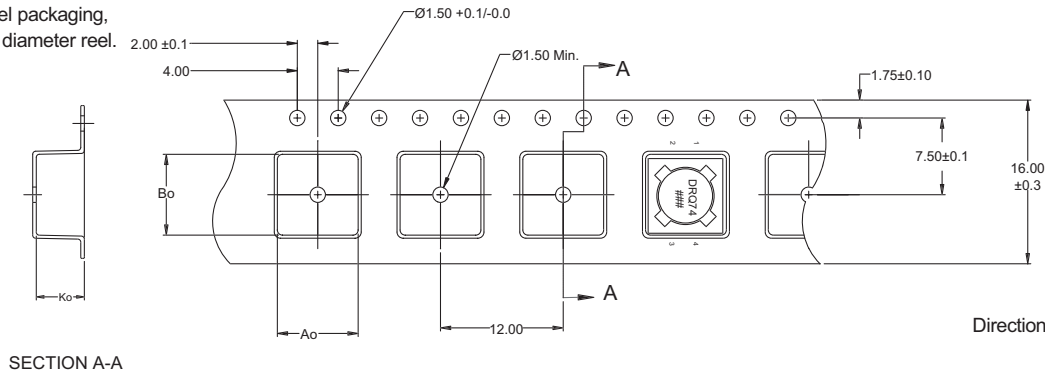

**DRQ125 Series**

Supplied in tape and reel packaging,  
600 parts per reel, 13" diameter reel.

Ao=13.00mm  
Bo=13.00mm  
Ko=6.30mm

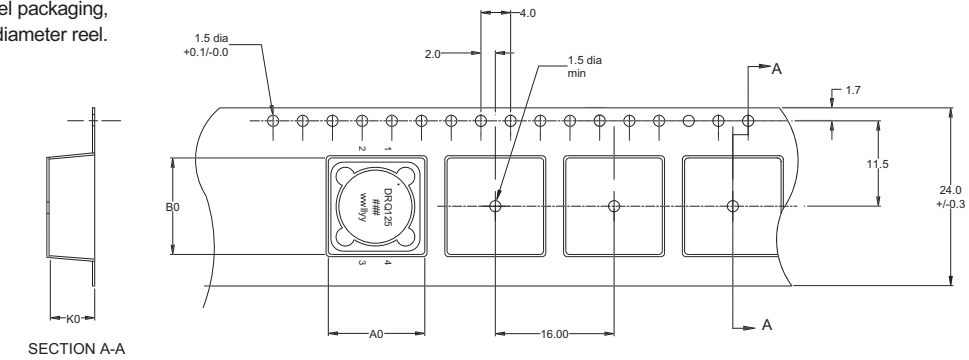

**DRQ127 Series**

Supplied in tape and reel packaging,  
350 parts per reel, 13" diameter reel.

Ao=13.00mm  
Bo=13.00mm  
Ko=8.30mm

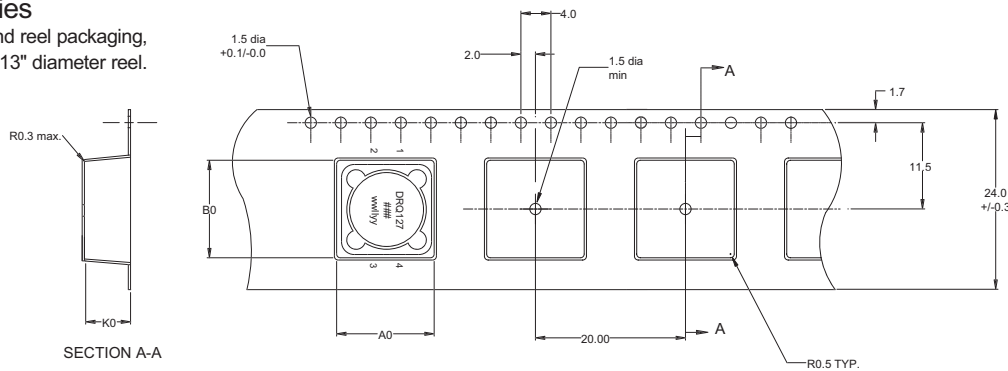

Dimensions are in millimeters.



Inductance characteristics

OCL vs  $I_{sat}$  DRQ73

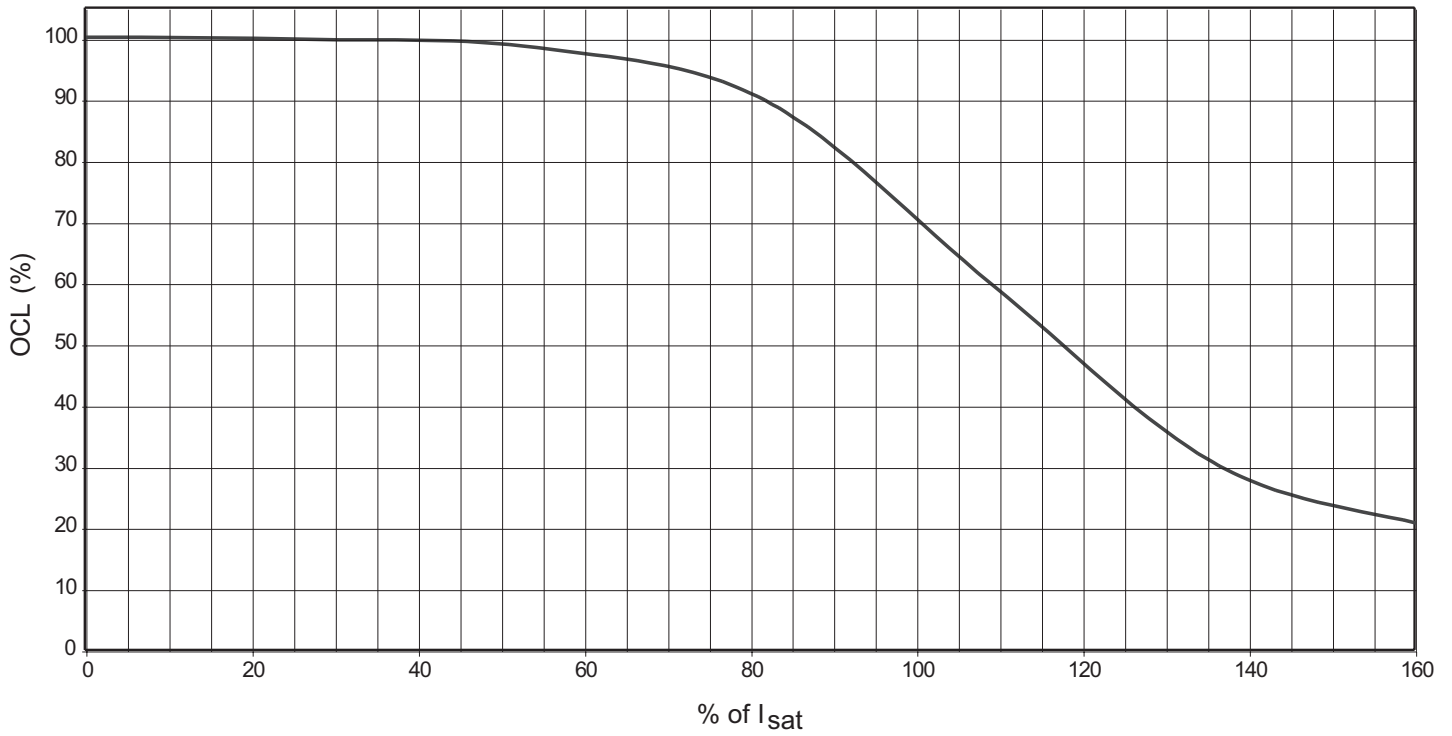

OCL vs  $I_{sat}$  DRQ74

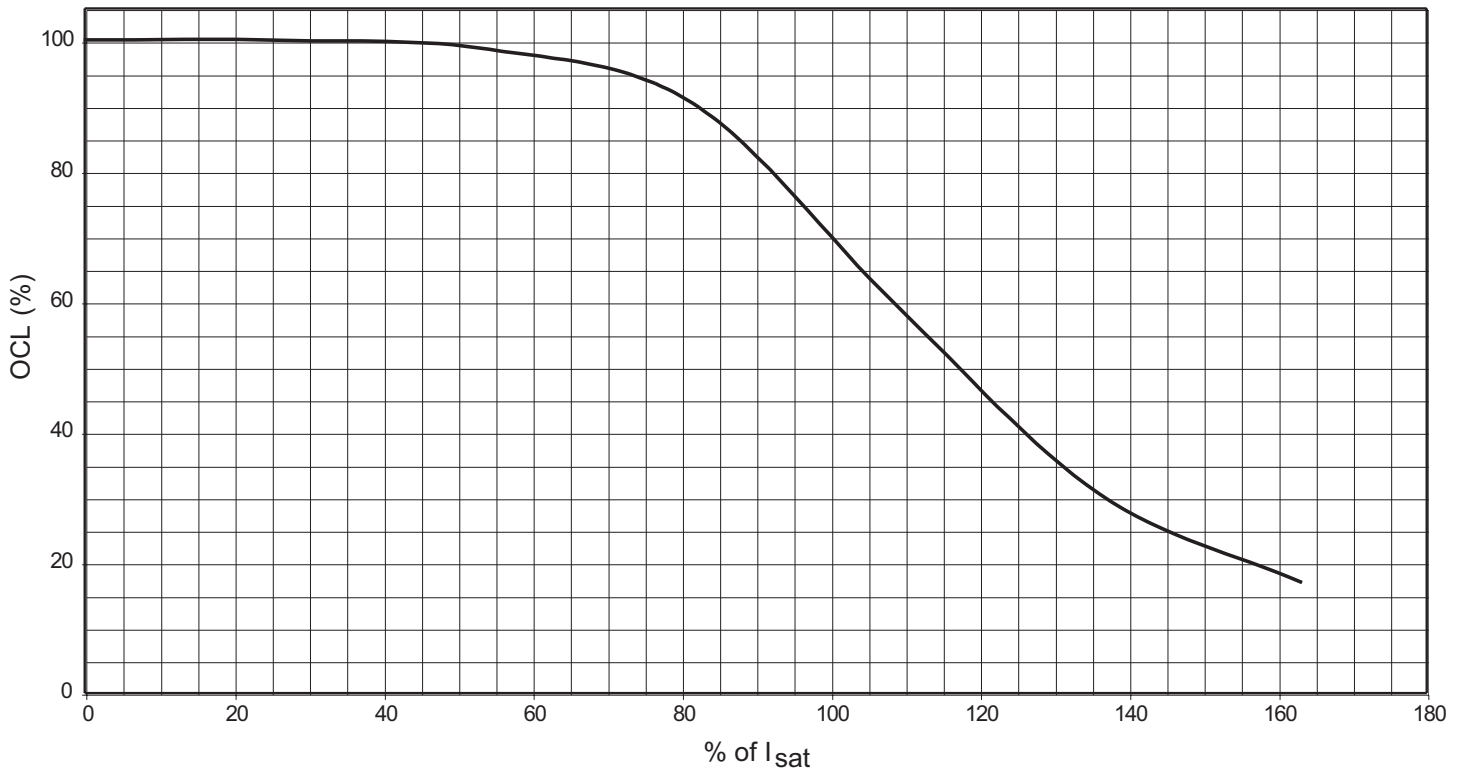

Inductance characteristics

OCL vs  $I_{sat}$  DRQ125

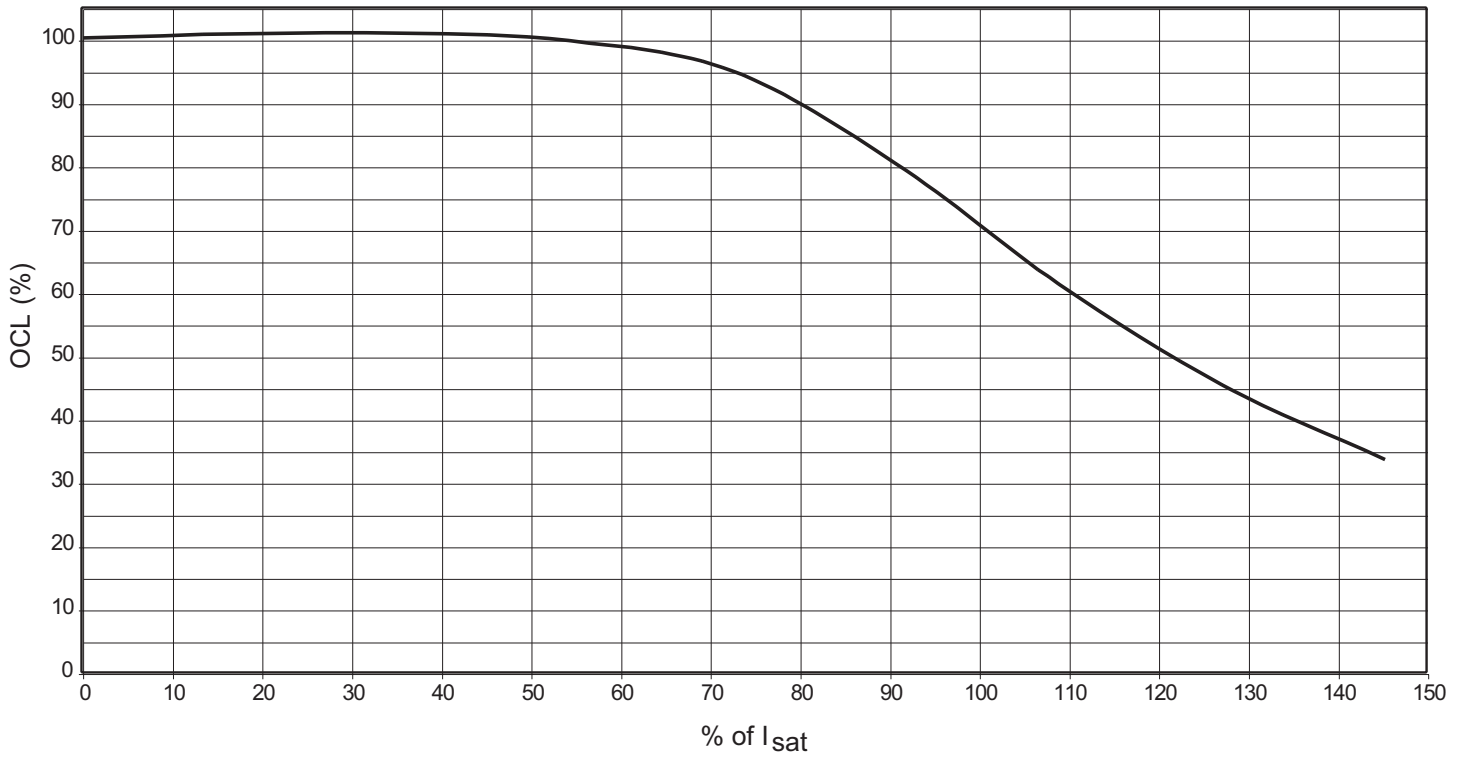

OCL vs  $I_{sat}$  DRQ127

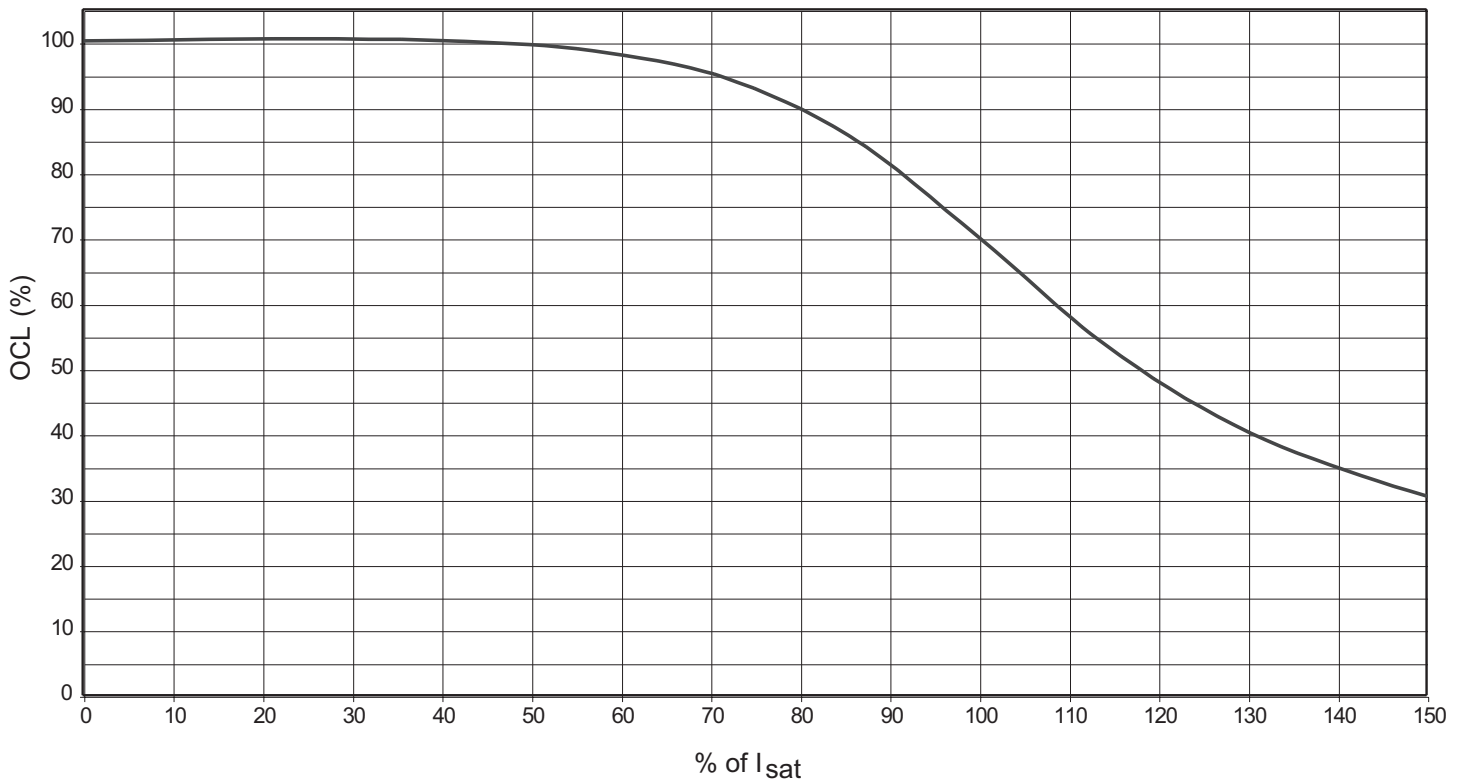

Core loss

$I_{rms}$  Derating with Core Loss

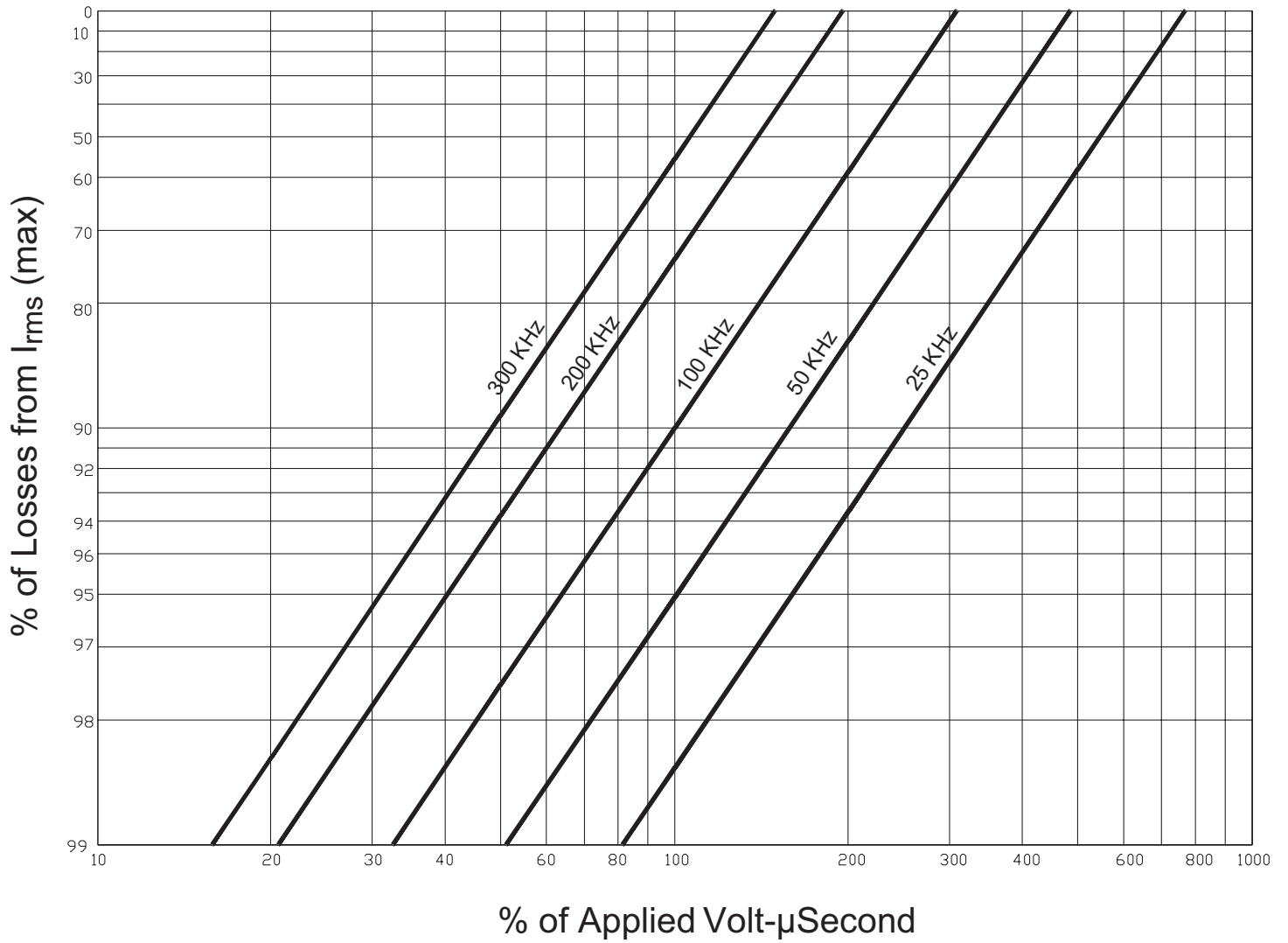

**Solder reflow profile**

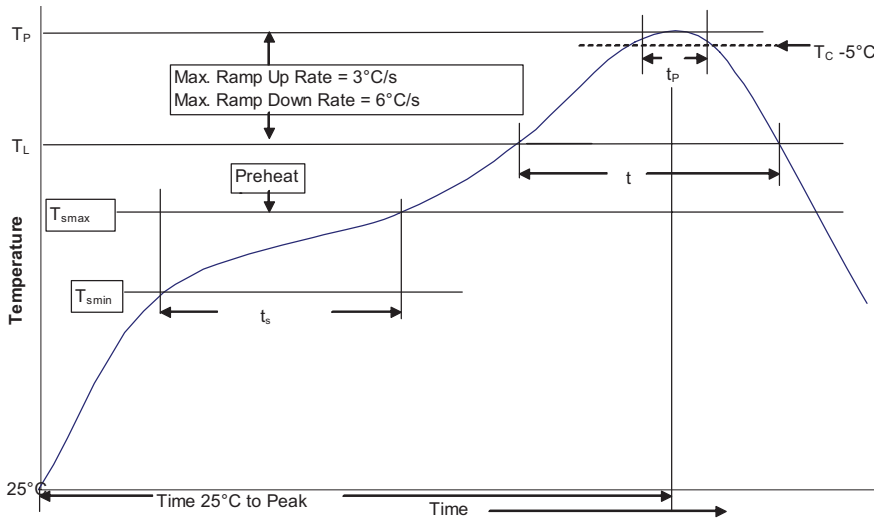

**Table 1 - Standard SnPb Solder ( $T_c$ )**

Package Thickness	Volume $\text{mm}^3$ <350	Volume $\text{mm}^3$ $\geq 350$
<2.5mm	235°C	220°C
$\geq 2.5\text{mm}$	220°C	220°C

**Table 2 - Lead (Pb) Free Solder ( $T_c$ )**

Package Thickness	Volume $\text{mm}^3$ <350	Volume $\text{mm}^3$ 350 - 2000	Volume $\text{mm}^3$ >2000
<1.6mm	260°C	260°C	260°C
1.6 – 2.5mm	260°C	250°C	245°C
>2.5mm	250°C	245°C	245°C

**Reference JDEC J-STD-020D**

Profile Feature	Standard SnPb Solder	Lead (Pb) Free Solder
Preheat and Soak	<ul style="list-style-type: none"> <li>Temperature min. (<math>T_{smin}</math>)</li> <li>Temperature max. (<math>T_{smax}</math>)</li> <li>Time (<math>T_{smin}</math> to <math>T_{smax}</math>) (<math>t_s</math>)</li> </ul>	<ul style="list-style-type: none"> <li>150°C</li> <li>200°C</li> <li>60-120 Seconds</li> </ul>
Average ramp up rate $T_{smax}$ to $T_p$	3°C/ Second Max.	3°C/ Second Max.
Liquidous temperature ( $T_L$ )	183°C	217°C
Time at liquidous ( $t_L$ )	60-150 Seconds	60-150 Seconds
Peak package body temperature ( $T_p$ )*	Table 1	Table 2
Time ( $t_p$ )** within 5 °C of the specified classification temperature ( $T_c$ )	20 Seconds**	30 Seconds**
Average ramp-down rate ( $T_p$ to $T_{smax}$ )	6°C/ Second Max.	6°C/ Second Max.
Time 25°C to Peak Temperature	6 Minutes Max.	8 Minutes Max.

\* Tolerance for peak profile temperature ( $T_p$ ) is defined as a supplier minimum and a user maximum.

\*\* Tolerance for time at peak profile temperature ( $t_p$ ) is defined as a supplier minimum and a user maximum.

**North America**

Eaton's Electrical Group  
Electronics Division  
1225 Broken Sound Parkway NW  
Suite F  
Boca Raton, FL 33487-3533  
Tel: 1-561-998-4100  
Fax: 1-561-241-6640  
Toll Free: 1-888-414-2645

Eaton's Electrical Group  
Electronics Division  
P.O. Box 14460  
St. Louis, MO 63178-4460  
Tel: 1-636-394-2877  
Fax: 1-636-527-1607

**Europe**

Eaton's Electrical Group  
Electronics Division  
Burton-on-the-Wolds  
Leicestershire, LE 12 5th UK  
Phone: +44 (0) 1509 882 600  
Fax: +44 (0) 1509 882 786

Eaton's Electrical Group  
Electronics Division  
Avda Santa Eulalia, 290  
Terrassa, Barcelona 08223 Spain  
Phone: +34-93-736-2813  
Fax: +34-93-783-5055

**Asia Pacific**

Eaton's Electrical Group  
Electronics Division  
No.2, #06-01  
Serangoon North Avenue 5  
Singapore 554911  
Tel: +65 6645 9888  
Fax: +65 6728 3155

The only controlled copy of this Data Sheet is the electronic read-only version located on the Bussmann Network Drive. All other copies of this document are by definition uncontrolled. This bulletin is intended to clearly present comprehensive product data and provide technical information that will help the end user with design applications. Bussmann reserves the right, without notice, to change design or construction of any products and to discontinue or limit distribution of any products. Bussmann also reserves the right to change or update, without notice, any technical information contained in this bulletin. Once a product has been selected, it should be tested by the user in all possible applications.

Life Support Policy: Bussmann does not authorize the use of any of its products for use in life support devices or systems without the express written approval of an officer of the Company. Life support systems are devices which support or sustain life, and whose failure to perform, when properly used in accordance with instructions for use provided in the labeling, can be reasonably expected to result in significant injury to the user.

**Eaton's Electrical Group  
Electronics Division**  
114 Old State Road  
Ellisville, MO 63021  
United States  
www.eaton.com/elx

© 2014 Eaton  
All Rights Reserved  
Publication No. 4311 — BU-SB14113  
April 2014



Powering Business Worldwide

Eaton is a registered trademark.

All other trademarks are property of their respective owners.