



IAL/CEL/LEL SERIES

HYDRAULIC MAGNETIC CIRCUIT PROTECTORS

Introduction

IAL/IUL/IEL/LEL magnetic circuit protectors provide low-cost power switching, reliable circuit protection and accurate circuit control for equipment in the international marketplace.

IAL models are for those applications where the unit's inherent attributes are desired, but compliance with the various standards is not required.



IUL models have been tested and approved in accordance with UL 1077 requirements for UL recognition.

IEL/LEL models are TUV approved to IEC 60947-2. They meet IEC spacing requirements, mandatory for equipment which must comply with IEC specifications. In addition, the IEL models are UL recognized to UL 1077 as supplementary protectors and the LEL models are UL listed under the conditions of UL 489. Both are CSA certified and CCC Approved. The IEL is CSA certified as a supplementary protector per CSA C22.2–No. 235.

The CEL model has achieved two new enhancements, including a single pole, 125 amp rating with TÜV approval, and a parallel 4-pole version with 400 amp rating.

Airpax™ IAL/CEL/LEL circuit protectors are available in a wide variety of configurations, including series, series with auxiliary switch, shunt and relay with choice of delays and ratings in DC and/or 50/60Hz or 400Hz versions. Single or multi-pole versions are available with a variety of pole arrangements to meet your specifications. Please see the appropriate product specification table for ratings and limitations.

SINGLE POLE, STANDARD STUD TERMINAL

Tolerance $\pm .015$ [.39] unless noted.
Dimensions in brackets [] are millimeters.

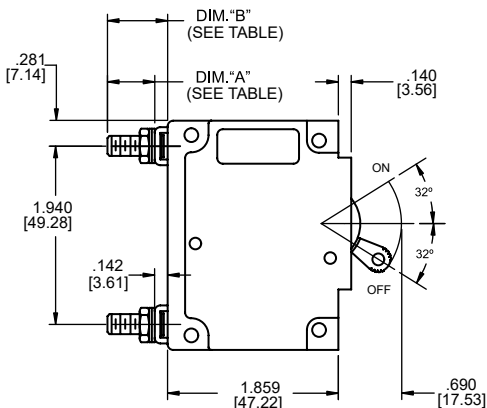

STUD TERMINAL TYPES		
Screw Stud Thread	Dimension "A"	Dimension "B"
M6	.510 \pm .045 [12.95 \pm 1.14]	.652 \pm .035 [16.56 \pm 0.89]
1/4 -20	.545 \pm .045 [13.84 \pm 1.14]	.687 \pm .035 [17.45 \pm 0.89]
M5	.510 \pm .045 [12.95 \pm 1.14]	.652 \pm .035 [16.56 \pm 0.89]
10-32	.545 \pm .045 [13.84 \pm 1.14]	.687 \pm .035 [17.45 \pm 0.89]

Single Pole

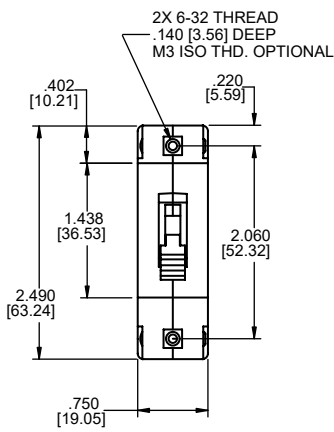

Mounting Detail

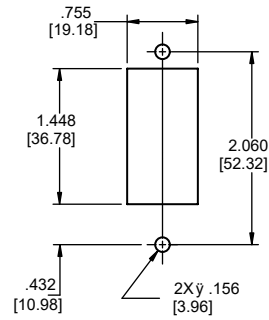

Panel Mounting Detail
Tolerance $\pm .005$ [.13] unless noted.

Screw Terminal

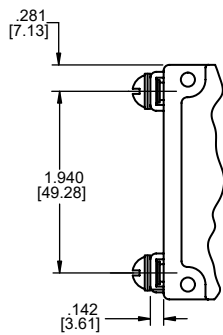

Clip Terminal

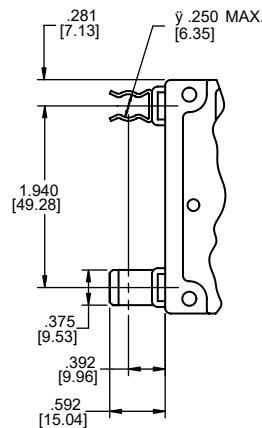

Bullet Terminal

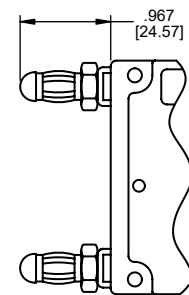

Notes:

A Terminal protrusion dimensions are referenced from back of mounting panel.

B Each screw terminal is supplied with a 10-32x.312 [7.92] or M5 x 8mm screw, flatwasher and external tooth lockwasher.

C Stud terminals are supplied with a flatwasher, external tooth lockwasher and a 10-32 or M5 hex nut ($\leq 70A$) ($\leq 50A$ for LEL), 1/4-20 or M6 hex nut ($> 70A$) ($> 50A$ for LEL).

Bullet terminal receptacle should be $.312 \pm .001$ diameter hole not less than .250 depth. Contact Sensata for other bullet sizes.

Each outer terminal is supplied with a flatwasher, tooth lockwasher and a hex nut.

MULTI-POLE CIRCUIT PROTECTORS

Multi-pole units are combined in an assembly with the trip mechanisms internally coupled. A fault in any protected circuit opens all poles simultaneously. Applications include use in polyphase circuits, single-phase three-wire systems, or in two or more related but electrically isolated circuits. A mix of delays, ratings and configurations are offered. The auxiliary switch is offered with either gold or silver contacts and is available when a series construction pole is specified.

Two Pole

An assembly consisting of two single pole units, having their trip mechanisms internally coupled, is available with either a single toggle handle or with a handle per pole. Please see decision one of the part number decision tables. Individual poles may vary in ratings, delays and internal configurations. If the poles are of series construction, an auxiliary switch may be included in either or both poles, allowing you to mix SELV and hazardous voltages.

Tolerance $\pm .015$ [.38] unless noted.
 Dimensions in brackets [] are millimeters.

Two Pole

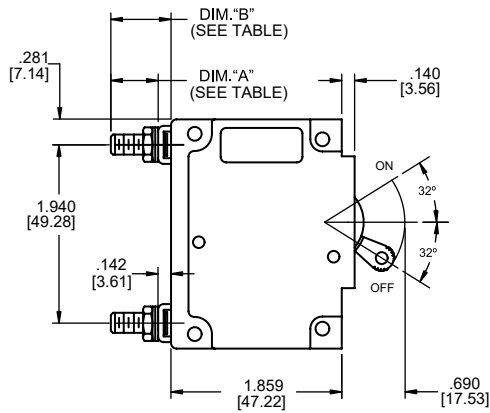

IELH11

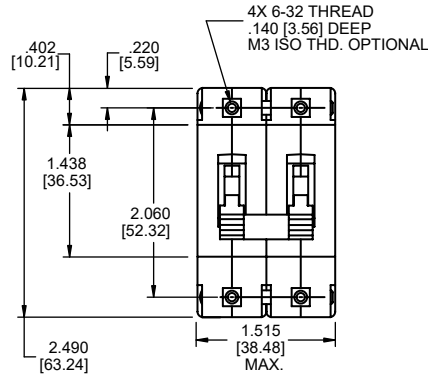

IEL11

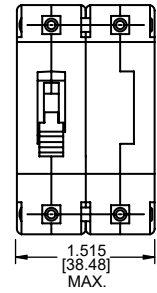

Two Pole*

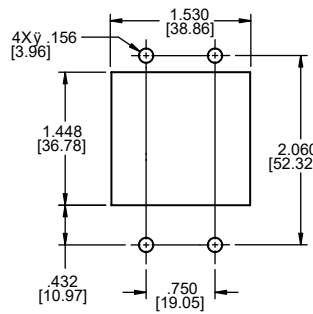

Two Pole*

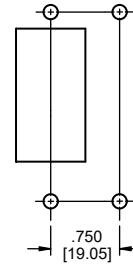

M6	.510	.652
1/4 - 20	.545	.687
M5	.510	.652
10 - 32	.545	.687
Screw stud thread	Dim. iA \hat{A} ($\pm .045$)	Dim. iB \hat{B} ($\pm .035$)

Note:
 Each outer terminal is supplied with a flatwasher, tooth lockwasher and a hex nut.

Note:
 A Terminal protrusion dimensions are referenced from back of mounting panel.
 B Each screw terminal is supplied with a 10-32x.312 [7.92] or M5 x 8mm screw, flatwasher and external tooth lockwasher.
 C Stud terminals are supplied with a flatwasher, external tooth lockwasher and a 10-32 or M5 hex nut ($\leq 70A$), 1/4 -20 or M6 hex nut ($>70A$).

Panel Mounting Detail
 Tolerance $\pm .005$ [.13] unless noted.

Three Pole and Four Pole Units

The three pole structure consists of three single pole units assembled with an internal mechanical interlock which actuates all units simultaneously. The units are available with either a single toggle handle or with a handle per pole.

Units with four pole construction operate with a minimum of two center toggle handles or with a handle per pole.

Please see decision one of the part number decision tables. Mixing of delays, ratings and configurations is available in each individual pole. The auxiliary switch is offered in any series trip pole.

Breaker poles are numbered consecutively when viewed from the terminal side, with the ON position up, starting with pole #1 on the left side and proceeding to the right.

Three Pole
IEL111

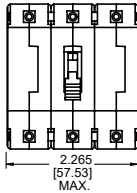

Mounting Detail*

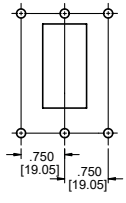

Three Pole
IELH111

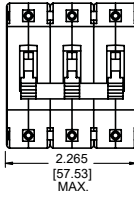

Mounting Detail*

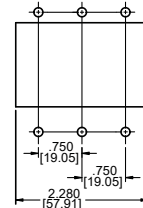

Four Pole
IEL1111

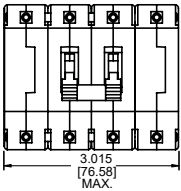

Mounting Detail*

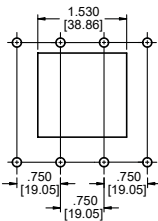

Four Pole
IELH1111

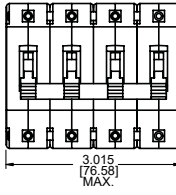

Mounting Detail*

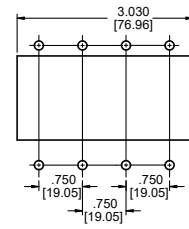

Panel Mounting Detail
Tolerance $\pm .005$ [.13] unless noted.

BX - FLAT ROCKER HANDLE

The innovative new design of our IAL/CEL/LEL BX Style circuit protectors features a flat rocker that will satisfy your aesthetic needs while guarding against accidental actuation, providing the highest degree of circuit protection and quality. Only Airpax offers this new standard in user interface. Available on a variety of versions with a full range of agency approvals, the IEL BX style circuit protectors meet or exceed all current performance specifications, including interrupting capacities up to 50,000 amperes.

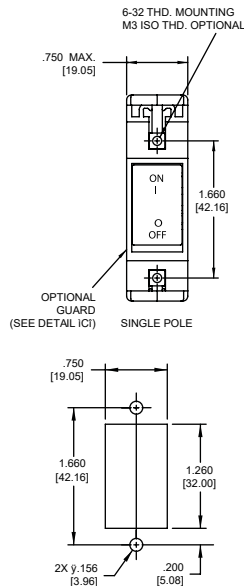
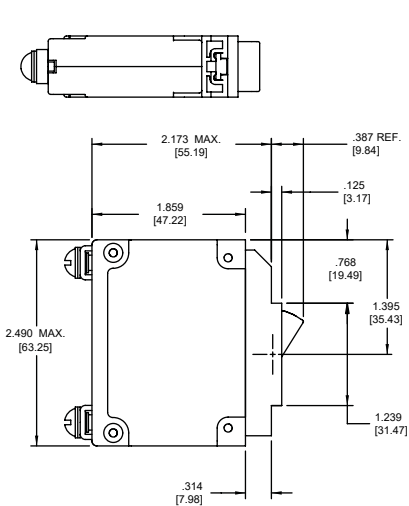

Panel Mounting Detail
Mounting Detail Tolerance:
 $\pm .005$ [.13] unless noted

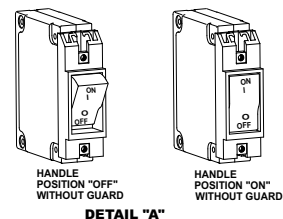
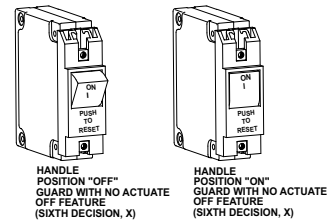
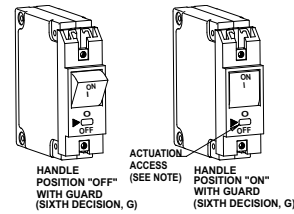

NOTE: ACCESS IS LIMITED TO A DEVICE SMALLER THAN THE UNDERWRITERS LABORATORY "ARTICULATED PROBE" DEFINED IN UL-489 FIG. 11.1.7.2.1.

Tolerance $\pm .015$ [.39] unless noted.
Dimensions in brackets [] are millimeters.
*See Single Pole Mounting Detail for Hole Sizes and Locations.

LELHP/CELHP CIRCUIT PROTECTORS

The Airpax™ LELHP/CELHP high current magnetic circuit protector compliments our entire series of LEL circuit protectors. Its unique, parallel current sensing design provides precise current overload protection and reliability in the compact size of a two pole LEL. The unit is ideal for high power DC applications such as drive motor systems and telecommunication power systems.

LEL is available in series and series with auxiliary switch configurations with a choice of delays for DC ratings of 125, 150, 175 and 200 amperes. The CEL has been enhanced to include these same ratings plus a 4-pole, parallel 400 amp rating for UL489A. The LELHP is UL listed under the conditions of UL489 and CSA certified. The CELHP is UL listed under the conditions of UL489A. Mid-trip handle indication, voltage trip and remote operator options complete the LELHP/CELHP circuit breaker series. Please see the individual product tables for approved ratings.

Tolerance $\pm .015$ [.39] unless noted. Dimensions in brackets [] are millimeters.

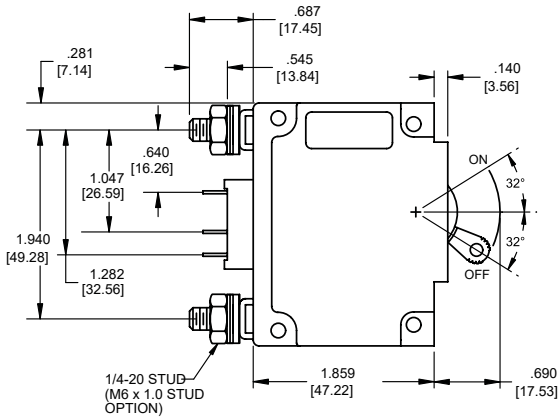

Series Parallel



Series Parallel with optional 1REC4 Auxiliary switch

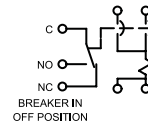

-REC4

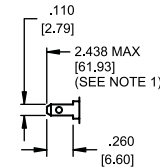

175/200 Parallel Pole



Two Pole

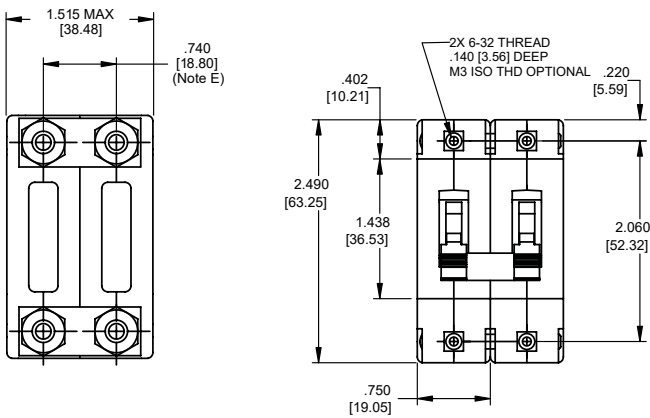

Three Pole (Note D)

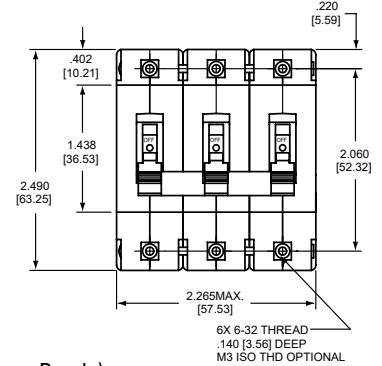
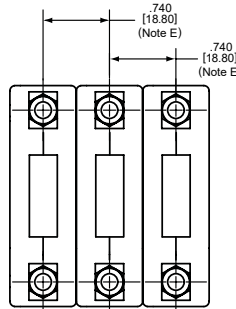

Four Pole (CEL __ P and CML __ P only)

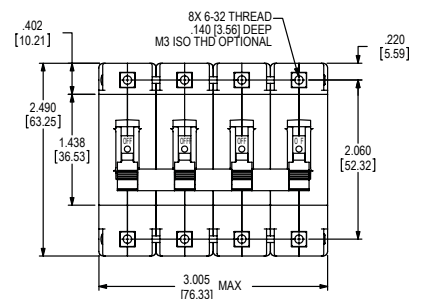
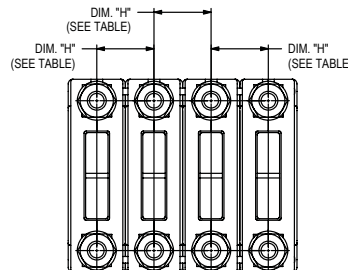

Notes:

- A Terminal protrusion dimensions are referenced from back of mounting panel.
- B Each screw terminal is supplied with a 10-32x.312[7.92] or M5 x 8mm screw, flatwasher and external tooth lockwasher.
- C Stud terminals are supplied with a flatwasher, external tooth lockwasher and a 10-32 or M5 hex nut ($\leq 70A$), 1/4 -20 or M6 hex nut ($>70A$).
- D Units are supplied without bus bars must have a minimum copper strap (1 31/32 x 1/2 x 1/16) of appropriate length to accommodate connections tying each set of terminals together.
- E Other spacing available upon request. Contact factory for assistance.



IALN/IULN PANEL SEAL CIRCUIT PROTECTORS

The IALN/IULN family is a sealed toggle version of the IAL/IUL family. The silicone rubber seal around the handle assures panel seal integrity and makes this style a natural for harsh environments.

This sealed toggle family is available in one to three pole models with ratings of .050 to 100 amperes.

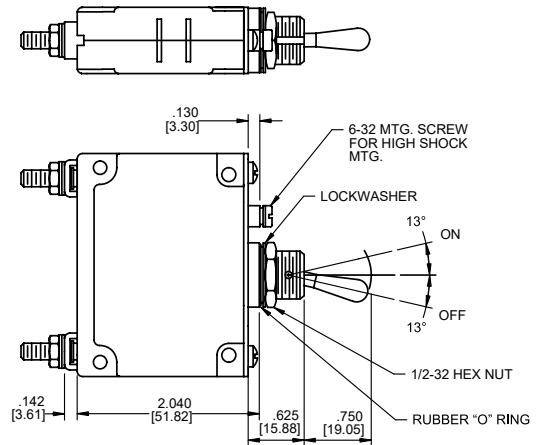

Single Pole

Two Pole

Three Pole

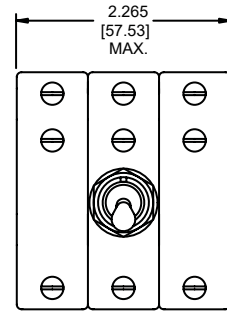
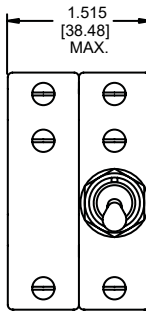
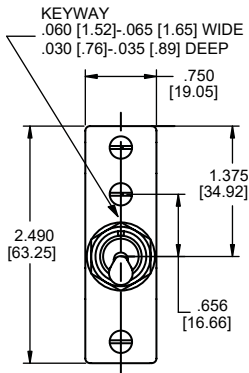

(Optional handle may be in pole 2 instead of pole 1.)

Panel Mounting Details: Tolerance $\pm .005$ [.13] Unless noted.

Single Pole

Two Pole*

Three Pole*

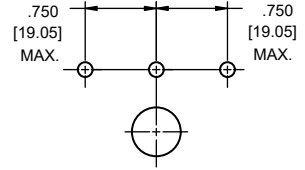
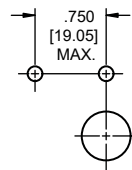
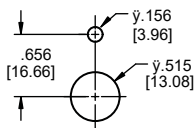

Optional handle

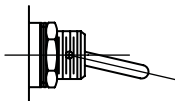

*See Single Pole Mounting Detail for Hole Sizes and Locations.

Notes:

- A Terminal protrusion dimension are referenced from back of mounting panel
- B Each screw terminal supplied with a 10-32x.312 [7.92] M5 x 8mm screw, flat washer and external tooth lockwasher
- C Stud terminal are supplied with a flat washer external tooth lockwasher and a 10-32 or M5 hex nut ($\leq 70A$) / 4-20 or M6 hex nut ($> 70A$).

IALZX/IULZX/IELZX ROCKER HANDLE

The IALZX/IULZX/IELZX style adds our rocker handle options of contrasting dual color rocker actuators, affording a clear visual indication of the handle position and integrated handle guards, to help prevent accidental turn-on and turn-off of the unit. Available with a black rocker and white, red or green indicator color for either ON or OFF indication.

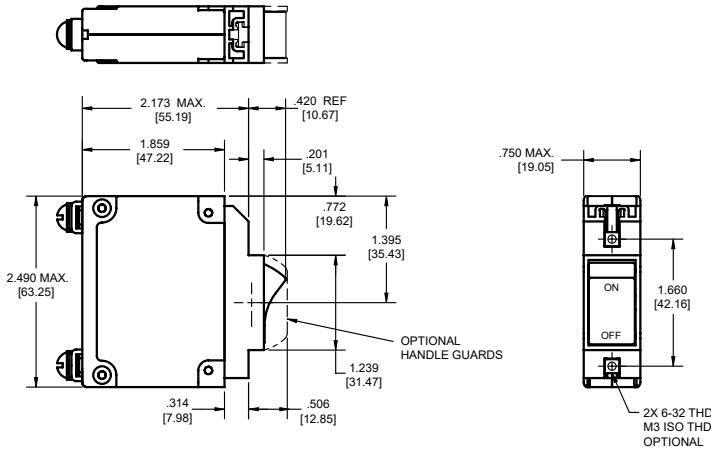

Note: Tolerance $\pm .015$ [.38] unless noted.
Dimensions in brackets [] are millimeters.

Panel Mounting Detail

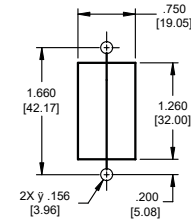

Panel Mounting Detail
Tolerance $\pm .005$ [.13] unless noted.

CONFIGURATIONS

Series Trip

The most popular configuration for magnetic protectors is the series trip where the sensing coil and contacts are in series with the load being protected. The handle position conveniently indicates circuit status. In addition to providing conventional overcurrent protection, it's simultaneously used as an on-off switch.

Shunt Trip

The shunt trip is designed for controlling two separate loads with one assembly. The control is established by providing overload protection for the critical load. When the current through this load becomes excessive and reaches the trip point, the protector will open and remove power from both loads simultaneously. The total current rating of both loads must not exceed the maximum contact rating.

Dual Coil

By combining two electrically independent coils on a common magnetic circuit, it is possible to provide contact opening when either an over-current or trip voltage is applied to the respective coils. One coil will be a current trip coil with standard specifications. The second, or dual coil, can be used to provide a control function permitting contact opening from a remote interlock or other transducer functions. Standard coils are 6, 12, 24, 48, 120 and 240 volts. Tripping is instantaneous and must be removed (usually self-interrupting) after trip.

Auxiliary Switch (Applies to Series Trip Only)

This is furnished as an integral part of a series pole in single or multi-pole assemblies. Isolated electrically from the protector's circuit, the switch works in unison with the power contacts and provides indication at a remote location of the protector's on-off status.

Auxiliary switch contacts actuate simultaneously with the main breaker contacts, and will open regardless of whether the breaker contacts are opened manually or electrically. For auxiliary switch ratings below 6Vac or 5Vdc, an auxiliary switch with gold contacts, designated as REG is available. Gold contacts are not recommended for load current above 100 milliamps.

Series and Switch Only

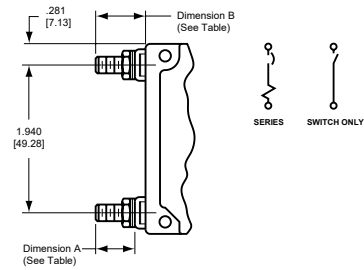

Shunt and Dual Coil

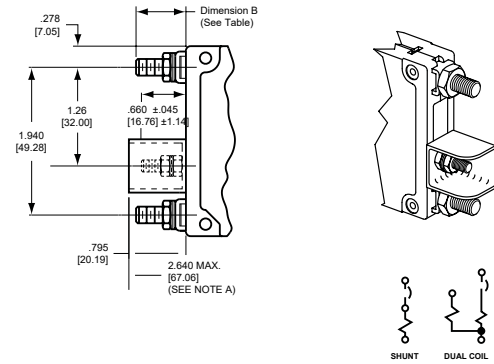

Series with Auxiliary Switch

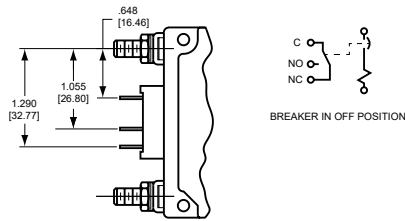

Spacing for TUV Switch

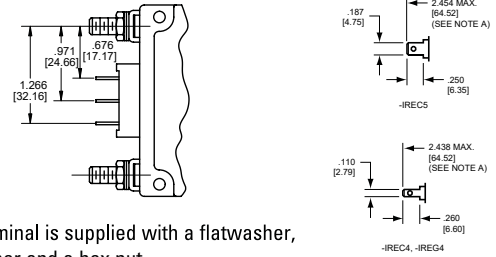

STUD TERMINAL TYPES		
Screw Stud Thread	Dimension "A"	Dimension "B"
M6	.510 ± .045 [12.95 ± 1.14]	.652 ± .035 [16.56 ± 0.89]
1/4 -20	.545 ± .045 [13.84 ± 1.14]	.687 ± .035 [17.45 ± 0.89]
M5	.510 ± .045 [12.95 ± 1.14]	.652 ± .035 [16.56 ± 0.89]
10-32	.545 ± .045 [13.84 ± 1.14]	.687 ± .035 [17.45 ± 0.89]

Note: Each outer terminal is supplied with a flatwasher, tooth lockwasher and a hex nut.

Note:

A Terminal protrusion dimensions are referenced from back of mounting panel.
 B Each screw terminal is supplied with a 10-32x.312[7.92] or M5 x 8mm screw, flatwasher and external tooth lockwasher.

C Stud terminals are supplied with a flatwasher, external tooth lock washer and a 10-32 or M5 hex nut (<=70A), 1/4-20 or M6 hex nut (>70A).

Relay Trip

This permits the overload sensing coil to be placed in a circuit which is electrically isolated from the trip contacts.

The coil may be actuated by sensors monitoring pressure, flow, temperature, speed, etc. Other typical applications include crowbar, interlock and emergency/rapid shutdown circuitry. Trip may be accomplished by voltage or current, which must be removed after trip.

Voltage Trip

Sometimes called "dump circuits" or "panic trip circuits", these units make it possible to open main power contacts with lower power inputs from one or more sources. This configuration is becoming increasingly more important for sensitive circuitry and denser packaging in automation systems. Available in series, shunt or relay configurations.

RelayandDualCoil

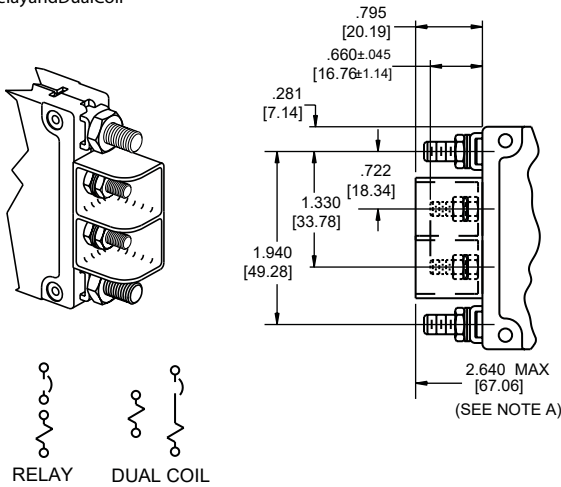

Notes:

Tolerance $\pm .015$ [.39] unless noted. Dimensions in brackets [] are millimeters.

A Terminal protrusion dimensions are referenced from back of mounting panel.

B Each screw terminal is supplied with a 10-32x.312[7.92] or M5 x 8mm screw, flatwasher and external tooth lockwasher.

C Stud terminals are supplied with a flatwasher, external tooth lockwasher and a 10-32 or M5 hex nut ($\leq 70A$), 1/4 -20 or M6 hex nut ($>70A$).

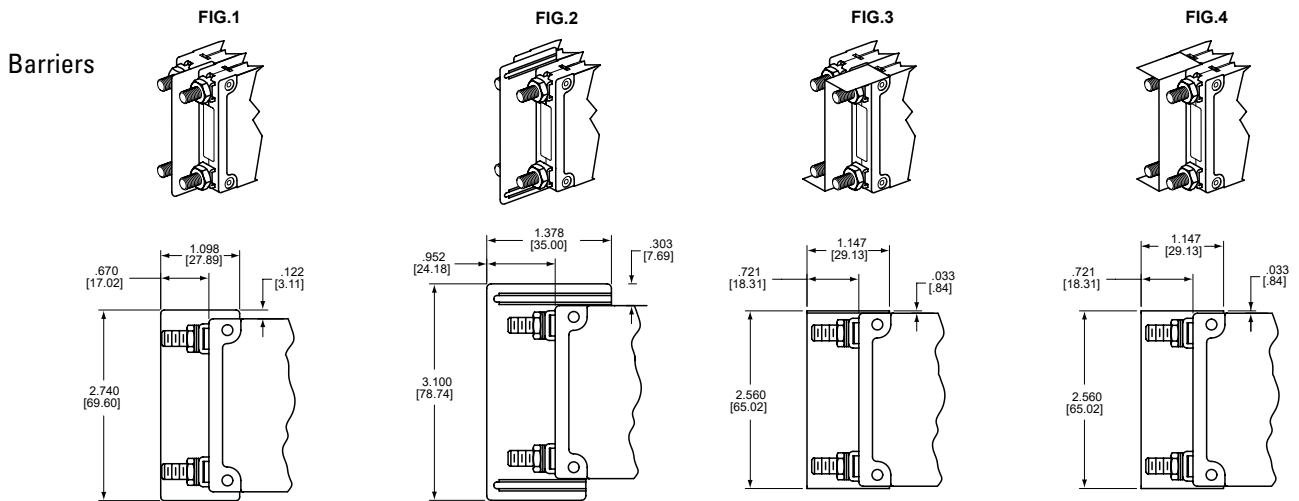

NOTE:
THIS BARRIER CAN BE FLIPPED
TO COVER EITHER POLE.
PLEASE CONTACT FACTORY FOR
SPECIFIC PART NUMBER

BARRIER OPTIONS		
Rating Option	Standard Barrier	Optional Barrier
IEL		
240/415 VAC	Fig. 1	Fig. 2, 3 & 4
415 VAC (TUV)		
277/480 VAC		
1/4-20, M6 studs for AC	Fig. 2	Fig. 3 & 4
120/240 VAC multi-pole		
125VDC		
LEL		
All multi-pole 50/60 Hz	Fig. 2	Fig. 3 & 4
All multi-pole 80 VDC, if opposite polarity	Fig. 2	Fig. 3 & 4
125VDC	Fig. 2	Fig. 3 & 4

Mid-Trip Indication

Circuit protection, rapid fault location and alarm capability are blended together in the Airpax mid-trip indication option. This option is designed for automatic handle movement to a middle position upon electrical overload, allowing for easier detection of the fault circuit and minimizing downtime due to the overload condition.

In the optional auxiliary switch configuration, the switch allows an alarm or signal to be forwarded when the breaker trips and the handle moves to the middle position. The alarm can be disengaged by the manual actuation of the handle to the OFF position. Once the fault has been corrected, the circuit breaker can be reset to the ON position. The mid-trip option is available in one, two or three pole toggle handle packages and in either standard panel screw or snap-in mounting. Please see specification tables of specific product for available ratings.

Snap-In Mounting

The snap-in mounting adapter allows for simplified mounting of most IEL/LEL toggle handle products. Prior to shipment, the adapter is attached to the circuit breaker during our final product assembly, allowing you to securely snap the unit into a rectangular panel cut-out.

This eliminates the need for panel mounting hardware and associated assembly costs.

Available for units up to three poles, with or without an option handle guard.

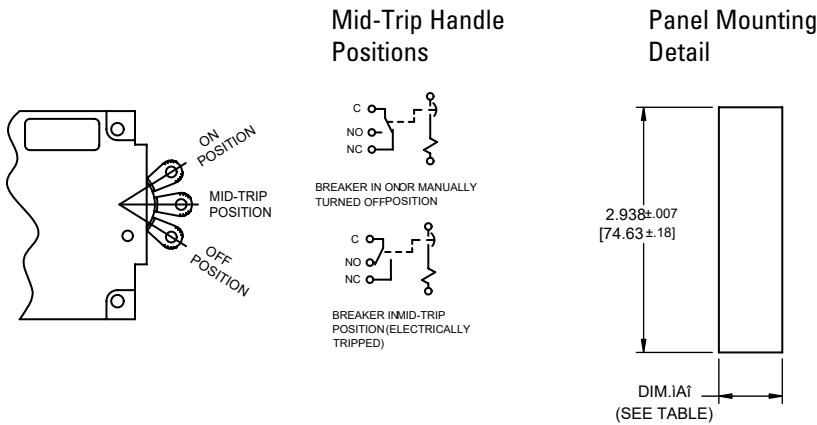

PANEL MOUNTING OPTIONS		
# of Poles	Dimension "A"	Panel Thickness
1 pole	.760 ± .007 [19.30 ± .18]	.062 ± .005 [1.57 ± .13]
2 pole	1.530 ± .007 [38.86 ± .18]	.062 ± .005 [1.57 ± .13]
3 pole	2.280 ± .007 [57.91 ± .18]	.062 ± .005 [1.57 ± .13]

Note: Tolerance ± .015 [.39] unless noted.

Dimensions in brackets [] are millimeters

Panel Mounting Detail

Tolerance ± .005 [.13] unless noted.

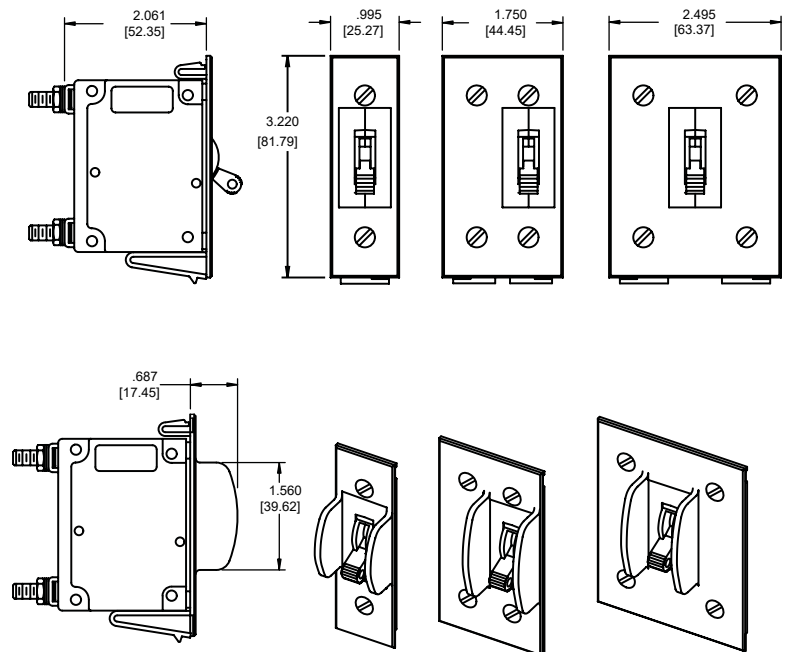



OPERATING CHARACTERISTICS

NOMINAL DCR /IMPEDANCE			
Current Ratings (Amps)	Resistance (ohms)	Impedance (ohms)	Impedance (ohms)
	DC Delays	AC, 50/60Hz Delays	AC, 400Hz Delays
	51, 52, 53, 59	61, 62, 63, 69	41, 42, 43, 49
0.20	45.8	28.5	71.94
1.0	1.38	1.10	2.85
2.0	0.371	0.29	0.76
5.0	0.055	0.051	0.12
10.0	0.017	0.016	0.032
20.0	0.006	0.006	0.010
30.0	0.003	0.004	0.006
50.0	0.0019	0.0018	0.0019
60.0	0.00157	0.00134	-
70.0	0.00147	0.00133	-
80.0	0.00146	0.00123	-
90.0	0.00135	0.00114	-
100.0	0.00135	0.00114	-
125.0	0.0005	-	-
150.0**	0.0005	-	-
165.0**	0.0004	-	-
175.0**	0.0004	-	-
200.0**	0.0004	-	-
250.0**	0.0004	-	-
400**	0.0003	-	-

Notes:
 DCR and impedance based on 100% rated current applied and stabilized a minimum of one hour.
 No 53 delay on 125 amp single pole or 400 amp four pole devices
 Tolerance: .02 amperes to 2.5 amperes, ± 20%; 2.6 amperes to 20 amperes, ± 25%; 21 amperes to 50 amperes, ± 50%. Consult factory for special values and for coil impedance of delays not shown
 ** Paralleled poles only, 400 amps only available on CELHP

PERCENTAGE OF RATED CURRENT VS TRIP TIME IN SECONDS AT +25°C								
Delay	100%	125%*	150%	200%	400%	600%	800%	1000%
41*	No Trip	May trip	.5 to 8	.15 to 1.9	.02 to .4	.006 to .25	.004 to .1	.004 to .05
42*	No Trip	May trip	5 to 70	2.2 to 25	.40 to 5	.012 to 2	.006 to .2	.006 to .15
43*	No Trip	May trip	35 to 350	12 to 120	1.5 to 20	.012 to 2.2	.01 to .22	.01 to .1
49*	No Trip	May trip	.100 max.	.050 max.	.020 max.	.020 max.	.020 max.	.020 max.
51	No Trip	.5 to 6.5	.3 to 3	.1 to 1.2	.031 to .5	.011 to .25	.004 to .1	.004 to .08
52	No Trip	2 to 60	1.8 to 30	1 to 10	.15 to 2	.04 to 1	.008 to .5	.006 to .1
53**	No Trip	80 to 700	40 to 400	15 to 150	2 to 20	.23 to 9	.015 to .55	.012 to .2
59	No Trip	.120 max.	.100 max.	.050 max.	.022 max.	.017 max.	.017 max.	.017 max.
61	No Trip	.7 to 12	.35 to 7	.130 to 3	.030 to 1	.015 to .3	.01 to .15	.008 to .1
62	No Trip	10 to 120	6 to 60	2 to 20	.2 to 3	.02 to 2	.015 to .8	.01 to .25
63	No Trip	50 to 700	30 to 400	10 to 150	1.5 to 20	.4 to 10	.013 to .85	.013 to .5
64*	No Trip	.7 to 12	.35 to 7	.130 to 3	.030 to 1	.017 to .3	.01 to .16	.008 to .1
65*	No Trip	10 to 120	6 to 60	2 to 20	.2 to 3	.02 to 2	.017 to .76	.01 to .6
66*	No Trip	50 to 700	30 to 400	10 to 150	1.5 to 20	.4 to 10	.014 to 5.0	.014 to 3.0
69	No Trip	.120 max.	.100 max.	.050 max.	.022 max.	.017 max.	.017 max.	.017 max.
71	No Trip	.44 to 10	.3 to 7	.100 to 3	.030 to 1	.012 to .3	.004 to .15	.004 to .1
72	No Trip	1.8 to 100	1.7 to 60	1 to 20	.15 to 3	.015 to 2	.008 to .79	.006 to .28
73	No Trip	50 to 600	30 to 400	10 to 150	1.8 to 20	.015 to 10	.015 to .88	.011 to .5
79	No Trip	.120 max.	.100 max.	.050 max.	.023 max.	.016 max.	.015 max.	.015 max.

Notes:
 All trip curves and trip currents are specified with the protector mounted in the normal vertical position at ambient temperature of +25° C. Protectors do not carry current prior to application of overload. A: Ratings above 30 amps may deviate from the above limits by approximately 10% (130% for delay 49).
 * No 53 delay on 125 amp single pole or 400 amp four pole devices
 * 135% for delay 71, 72, 73 & 79
 * Delays, 64, 65, and 66 are used only for shunt plate constructions, will not be TUV or CCC approved.

DELAY CURVES

400Hz, DC, 50/60Hz Delay Curves (typ)

A choice of delay is offered for DC, 50/60Hz, 400Hz, or combined DC/50/60Hz applications. Delays 49, 59, 69 and 79 provide fast-acting, instantaneous tripping and are often used to protect sensitive electronic equipment (not recommended where a known inrush exists). Delays 41, 51, 61 and 71 have a short delay for general purpose applications. Delays 42, 52, 62 and 72 are long enough for most transformers and capacitor loads. Delays 43, 53, 63 and 73 are extra long for special motor applications.

Inrush Pulse Tolerance

Pulse tolerance is defined as a single pulse of half sine wave peak current amplitude of 8 milliseconds duration that will not trip the circuit breaker.

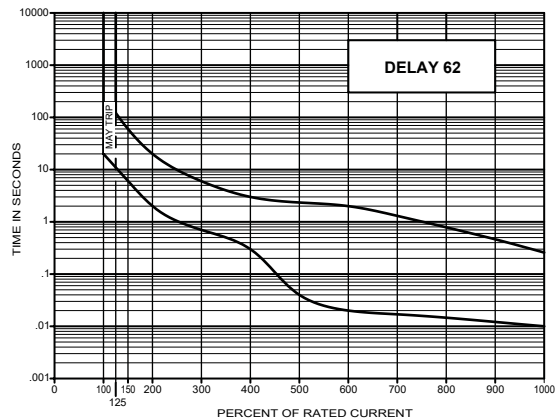
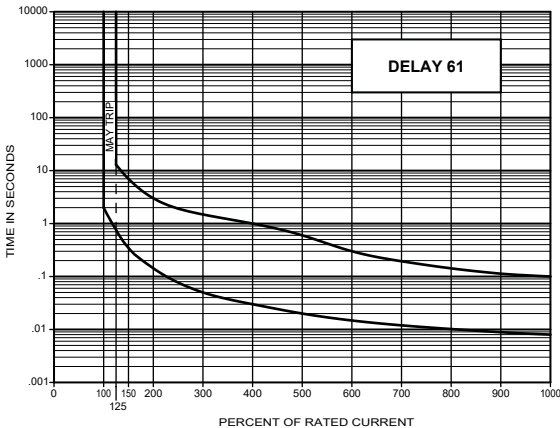

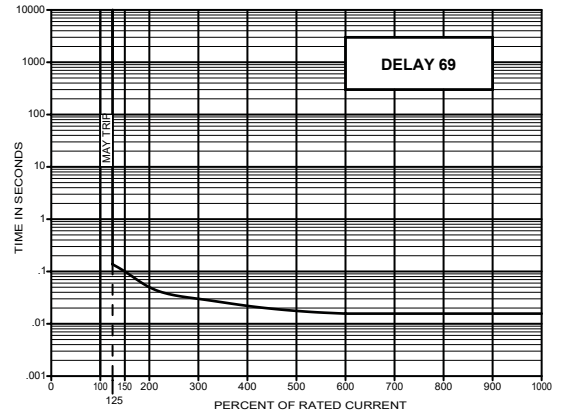
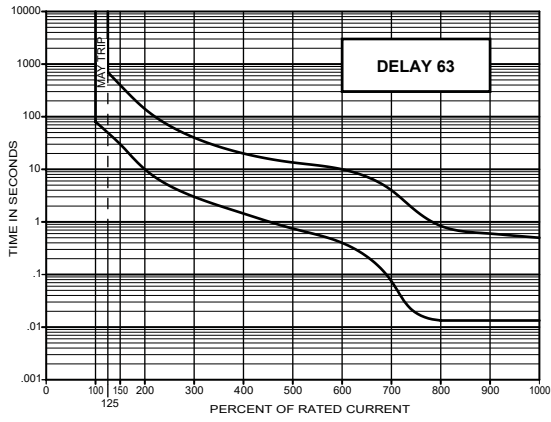

400Hz, DC, 50/60Hz Delay Curves (typ)

PULSE TOLERANCES	
Delay	Pulse Tolerance
61, 62, 63, 71, 72, 73	10 times (approx.) rated current
61F, 62F, 63F, 71F, 72F, 73F	12 times (approx.) rated current
64, 65, 66 (0 - 50A)	25 times (approx.) rated current
64, 65, 66 (>50 - 80A)	20 times (approx.) rated current
64, 65, 66 (>80 - 100A)	18 times (approx.) rated current

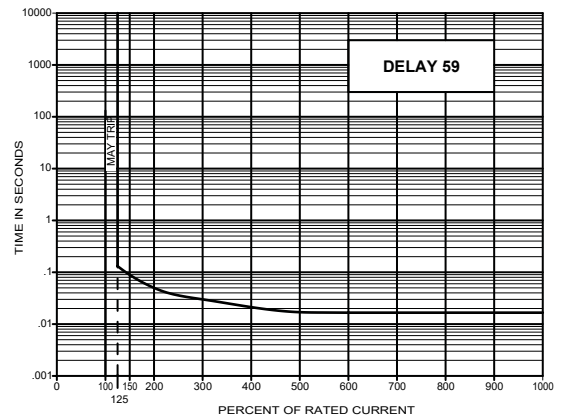
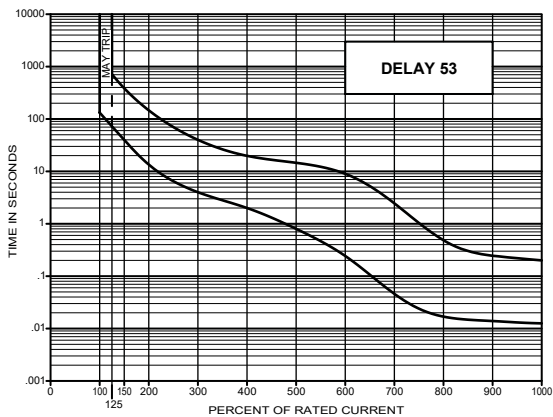
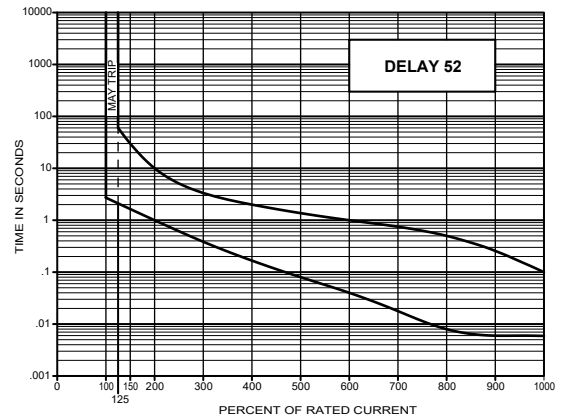
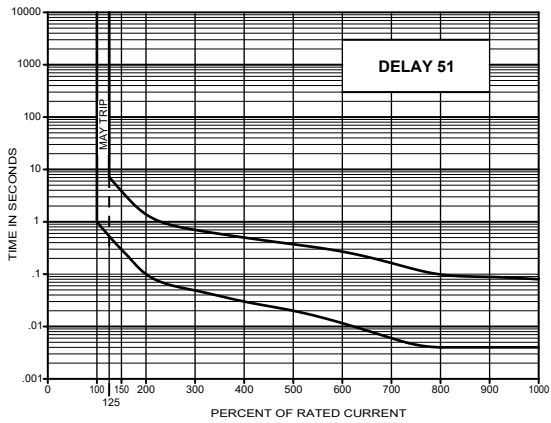

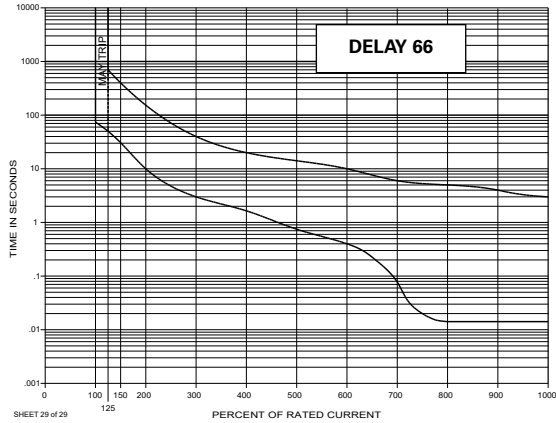
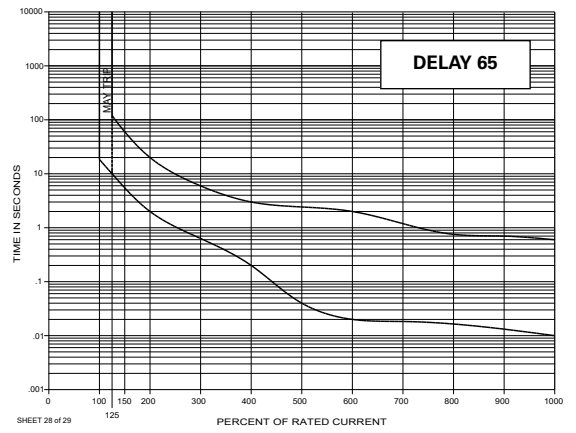
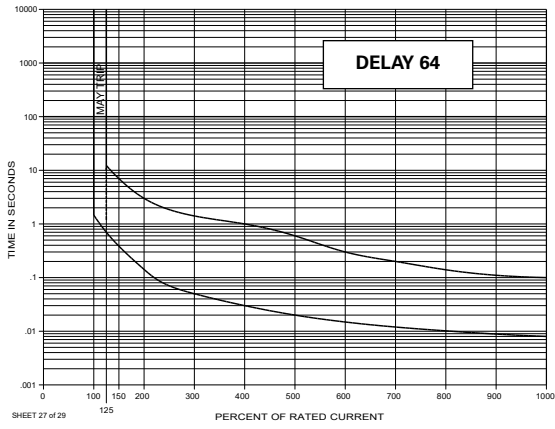

400Hz Delay Curves (typ)

* Available only in IAL/IUL/IEL; not available in LEL.

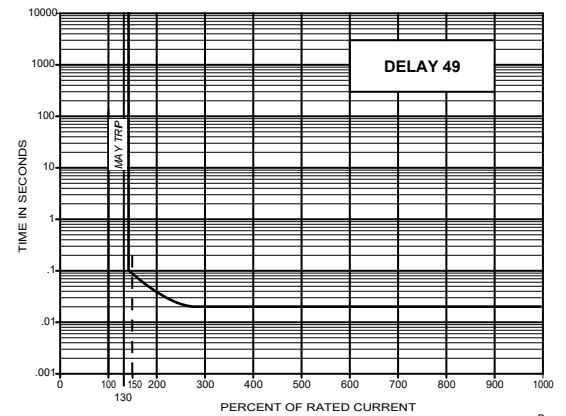
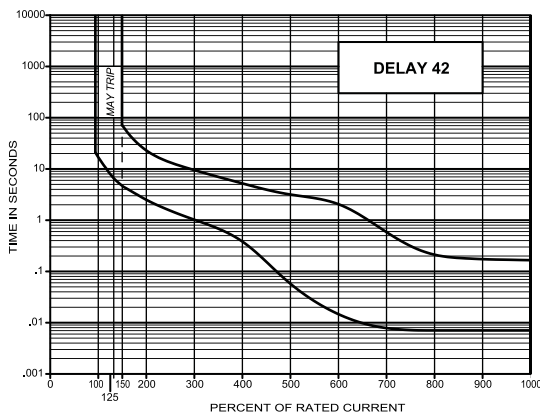
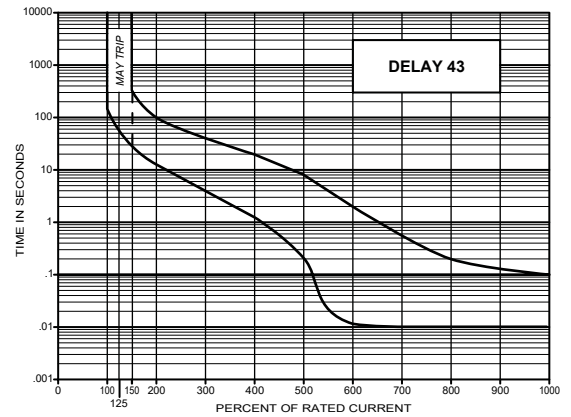
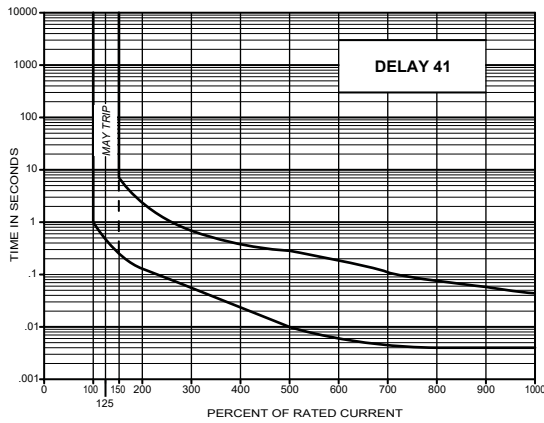

400Hz Delay Curves (typ)

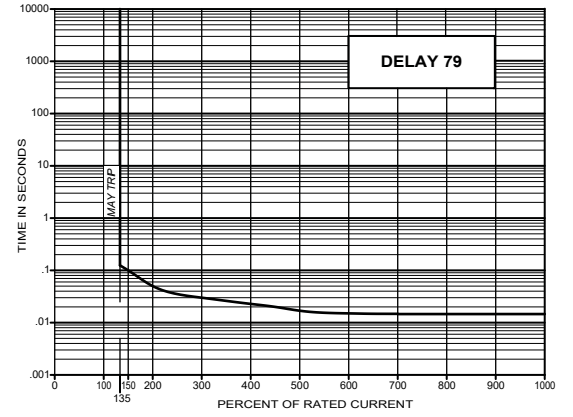
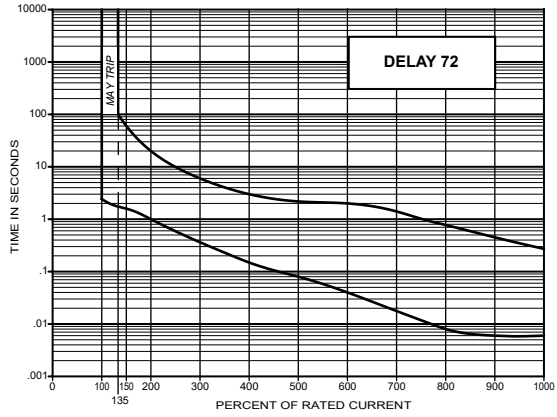
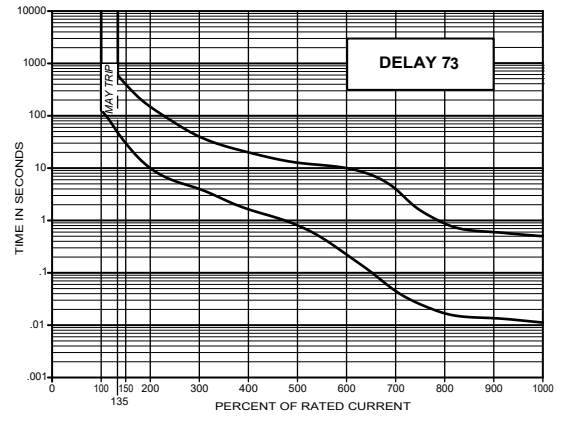
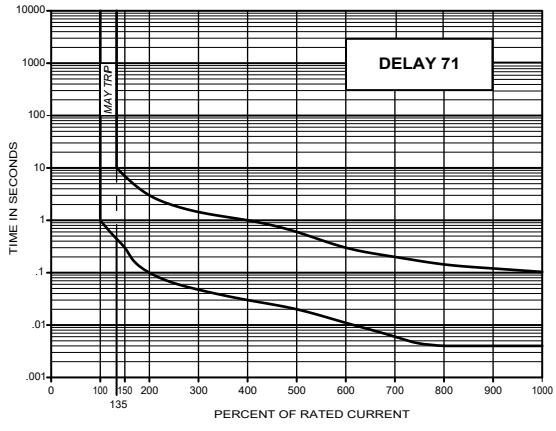



Trip Free

Will trip open on overload even when forcibly held in the ON position. This prevents the operator from damaging the circuit by holding the breaker on.
Trip Indication

The operating handle moves positively to the OFF or mid-trip position on electrical overload.

Ambient Operation

IAL/IUL/IEL protectors operate in temperatures between -40°C to $+85^{\circ}\text{C}$.

Insulation Resistance

Not less than 100 megohms at 500 volts DC.

Dielectric Strength

IAL/IUL/IEL protectors withstand 3750Vac (1250Vac for LEL), 60Hz for 60 seconds between all electrically isolated terminals except auxiliary switch terminals shall withstand 600Vac, 60Hz for REG and REC types. Four terminal dual coil and relay construction (not offered in the LEL) will withstand 1500Vac.

Endurance

Operating as a switch, the operating life exceeds 10,000 operations, 6000 at rated load, 4000 without load, at a rate of 6 per minute.

Electrical Characteristics

.050-100 amperes 80Vdc, 240Vac Max., 240/415Vac at 50 amperes Max., 50/60Hz and 400Hz. Consult factory for specific product ratings. Units rated for 240/415Vac and above 50 amperes are not suitable for across-the-line motor starting.

Poles

One through six poles available.

Construction

Series, shunt, relay dual coil and series with auxiliary switch available in various delays and combinations.

Auxiliary Switch

When supplied shall be S.P.D.T. configuration. Non TUV approved switches have a maximum UL rating of 10.0 amperes, 250 volts, 60Hz; 3.0 amperes, 50 volts DC (REC type) or 0.1 amperes, 125 volts, 60Hz (REG type).

TUV approved switches have a maximum UL rating of 10.0 amperes, 250 volts, 60Hz (REC type); or 0.1 amperes, 125 volts, 60Hz (REG; type). The maximum VDE ratings are 1.0 amperes, 125 volts, 60Hz (REC type); 0.1 amperes, 125 volts, 60Hz (REG type).

Salt Spray (Corrosion)

Meet the requirements of MIL-PRF-55629 when tested in accordance with Method 101 of MIL-STD-202.

Moisture Resistance

Meet all the requirements of MIL-PRF-55629 when tested in accordance with Method 106 of MIL-STD-202.

Shock

Circuit protectors shall not trip when tested per MIL-STD-202, Method 213, Test Condition I with 100% rated current applied to delayed units and 80% rated current to instantaneous units.

Vibration

Circuit protectors shall not trip when vibrated per MILSTD- 202, Method 204, Test Condition A with 100% rated current applied to delayed units and 80% rated current to instantaneous units.

UL-1500 (Marine Ignition Protected)

The IDL/IDLH is approved for Marine Ignition Protection (series configuration only), covering ignition protected circuit breakers. This specification requires devices to be used in accordance with the requirements of U.S. Coast Guard and Fire Protection Standard for Pleasure and Commercial Motor Craft, ANSI/MFPA #302.

APPROXIMATE WEIGHT PER POLE	
Ounces	Grams
3.1	90

RECOMMENDED TORQUE SPECIFICATIONS	
Component	Torque (in-lbs)
6-32 Mounting Inserts	6 to 8
M3 Mounting Screws	4 to 5
10-32 Screw Terminals	14 to 15
M5 Terminal Screws	14 to 15
10-32 Stud Terminals	13 to 14
M5 Stud Terminals	13 to 14
1/4 - 20 Stud Terminals	40 to 45
M6 Stud Terminals	40 to 45
1/2 - 32 Mounting Bushing	30 to 35

Where applicable, mechanical support must be provided to the terminals when applying torque

The ordering code for IAL/IUL/IEL/LEL circuit protectors may be determined by following the decision steps in the appropriate part number decision table subsequent to this page.

The coding given permits a self-assigning part number but with certain limitations.

Special applications may require a factory assigned part number. Typical examples are units with mixed ratings, combinations of styles, or constructions not listed in the third decision table, etc. With these, it is suggested that order entry be by description and/or drawings, and a part number will be established. Additionally, it is standard policy to establish a factory assigned part number whenever a descriptive drawing exists to provide cross reference, traceability and manufacturing control.

When specifying a circuit breaker for AC motor start or high inrush applications, the peak amplitude and surge duration should be specified for factory assistance in rating selection.

For example the code shown is the code for a single pole breaker with a series construction and auxiliary switch, designed for operation in a 50/60Hz circuit. It has a short time delay, rating of 20 amperes and a marked black handle, and is TUV approved.

To determine the ordering number for your particular IAL/IUL/IEL unit, simply follow the steps shown. You may use this number to place an order or as a reference for further questions you may have.

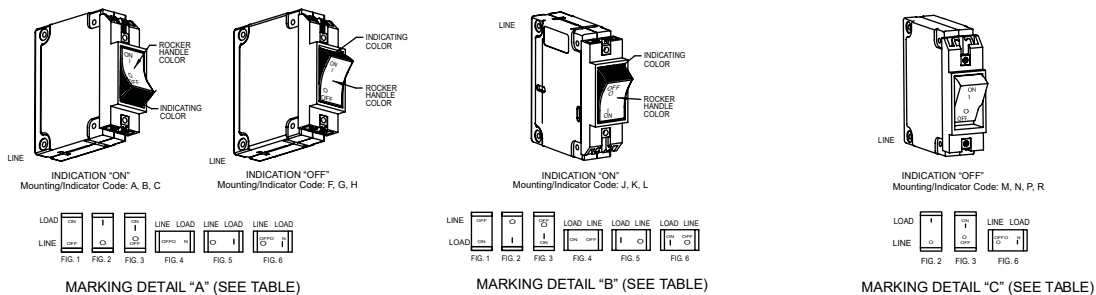

Notes:

IEL, IELH and IELX circuit protectors are designed to meet 8mm creepage clearance requirements for installation Category 111, Pollution Degree 3, Case A as measured in IEC 664. Intended for use in equipment to comply with IEC 950, 601.



IEL - 1 - 1REC4 - 61 - 20.0 - 01 - V

Type

- IAL:** One handle per unit
- **IUL:** One handle per unit
- ***IEL:** One handle per unit
- IALH:** One handle per pole
- **IULH:** One handle per pole
- ***IELH:** One handle per pole
- IALN:** One handle per unit panel seal
- ***IULN:** One handle per unit panel seal
- IALZX:** One handle per unit, rocker, integral mounting
- **IULZX:** One handle per unit, rocker, integral mounting
- ***IELZX:** One handle per unit, rocker, integral mounting
- *IDL:** One handle per unit UL 1500
- *IDLH:** One handle per pole UL 1500
- ***IML:** One handle per unit mid trip indication
- ***IMLH:** One handle per pole mid trip indication
- IALBX:** One handle per unit, rocker, accidental-off protection
- **IULBX:** One handle per unit, rocker, accidental-off protection
- ***IELBX:** One handle per unit, rocker, accidental-off protection
- **IMLBX:** One handle per unit, mid trip indication, rocker, accidental-off protection

Terminal

- Standard screw terminal, no designation required
- K:** Stud terminals
- B:** Bullet terminals

Poles

- 1:** Single pole
- 11:** Two pole
- 111:** Three pole
- 1111:** Four pole*
- *Not available in toggle seal handle type.
- Consult factory for 5 and 6 pole IEL part number.

Internal Configuration

- 0:** Switch only (50, 70 or 100 amp switch)
- 1:** Series
- 1REC4:** Series with auxiliary switch* .110 quick connect
- 1REC5:** Series with auxiliary switch* .187 quick connect
- 1REG4:** Series with auxiliary switch* .110 quick connect
- 1RS4:** Series with alarm switch, electrical trip, .110 quick connect terminals
- 1RLS4:** Series with alarm switch, electrical trip, .110 quick connect terminals (mid-trip only)
- 1RS5:** Series with alarm switch, electrical trip, .187 quick connect terminals
- 3:** Shunt
- 4:** Relay (not available in IEL/IELX)

Frequency & Delay

- SW:** Switch only
- 41:** 400Hz short delay
- 42:** 400Hz long delay
- 43:** 400Hz motor start
- 49:** 400Hz 150% instant trip
- 51:** DC short delay
- 52:** DC long delay
- 53:** DC motor start
- 59:** DC 125% instant trip
- 61:** 50/60Hz short delay
- 62:** 50/60Hz long delay
- 63:** 50/60Hz motor start
- 64:** 50/60Hz short delay
- 65:** 50/60Hz long delay
- 66:** 50/60Hz motor start
- 69:** 50/60Hz 125% instant trip
- 71:** DC/60Hz short delay
- 72:** DC/60Hz long delay
- 73:** DC/60Hz motor start
- 79:** DC/60 Hz 135% instant trip

Rated Current

Use three numbers to print required current value between .100 amps minimum and 100 amps maximum

Optional

Standard hardware. No designation required.

- A**: Metric thread mounting inserts and terminals
- B**: Standard Barrier
- C**: 277V (50/60Hz only) (See note 3)
- D**: 240/415V (50/60Hz only)
- E**: 277V/480V (50/60Hz only) (See note 4)
- G**: Handle guard, (available in ZX, BX and snap-in versions only)
- K**: 1/4 - 20 stud (M6 stud when -A option is selected) (<=70A requires -K, if >70A do not use -K)
- L**: Handle lock
- M**: Handle in opposite pole
- P**: Snap-in face plate adapter
- U**: 120/240V 50/60Hz
- X**: Handle guard with no actuation feature (BX rocker only)
- 1**: Silver 5/16" (.312") bullet

Notes:

1. One or more descriptions may be used as required.
2. When this is not used, table one may be substituted and U.S. thread and two lockwashers will be supplied. Unit will be rated at 250V (50/60Hz only.)
3. TUV approved at 250Vac
4. TUV approved at 415Vac

Handle Color and Marking Selection

IAL, IUL, IEL, IALH, IULH, IELH - Toggle Handle

-**01 (STD)**: Black

-**11**: Yellow

-**21**: Red

-**91**: White

Marked*

ON-OFF

I-O

Rocker Handle Color, Indicator Color and Marking Selection (See Notes)

IALZX, IULZX, IELZX Rocker Handle (Single Rocker Color)

Rocker Handle Color	Indicating Color	Marking Color	Indicates:	Vertical Mounting		Horizontal Mounting		Marking Detail
				On-Off	I-O Fig.3	On-Off	I-O Fig.6	
Black	N/A	White	N/A		-03		-06	
Red	N/A	White	N/A		-23		-26	
Grey	N/A	Black	N/A		-43		-46	A
Orange	N/A	Black	N/A		-53		-56	
White	N/A	Black	N/A		-93		-96	

IALZX, IULZX, IELZX Rocker Handle (Dual Rocker Color)

Black	White	White	On		-A3		-A6	
Black	Red	White	On		-B3		-B6	
Black	Green	White	On		-C3		-C6	
Black	White	White	Off		-F3		-F6	A
Black	Red	White	Off		-G3		-G6	
Black	Green	White	Off		-H3		-H6	
Black	White	White	On		-J3		-J6	
Black	Red	White	On		-K3		-K6	B
Black	Green	White	On		-L3		-L6	

IALBX, IULBX, IELBX, LELBX Rocker Handle (Dual Rocker Color)

Black	White	White	Off		-M3		-M6	
Black	Red	Red	Off		-N3		-N6	
Black	Green	Green	Off		-P3		-P6	C
Black	Yellow	Yellow	Off		-R3		-R6	

A. Bezels of IALBX, IULBX, IELB, IELBX are black.

B. Consult factory for other marking options.



LEL - 1 - 1REC4 - 61 - 20.0 - 01 - V

Type

- LEL:** One handle per unit
- LELH:** One handle per pole
- LML:** One handle per unit mid trip indication
- LMLH:** One handle per pole mid trip indication
- LELZX:** One handle per unit, rocker, integral mounting
- LMLZX:** One handle per unit, rocker, mid-trip indication, integral mounting
- LEL BX:** One handle per unit, rocker, accidental-off protected
- LML BX:** One handle per unit, rocker, mid-trip indication, accidental-off protected
- Terminal**
- Standard screw terminal, no designation required
- K:** Stud terminals
- B:** Bullet terminals

Poles

- 1:** Single pole
- 11:** Two pole
- 111:** Three pole

Internal Configuration

- 1:** Series
 - 1REC4:** Series with auxiliary switch .110 quick connect
 - 1REC5:** Series with auxiliary switch .187 quick connect
 - 1REG4:** Series with auxiliary switch (gold contacts) .110 quick connect
 - 1RS4:** Series with alarm switch, electrical trip, .110 quick connect
 - 1RLS4:** Series with alarm switch, electrical trip, .110 quick connect*
- * Used only with mid-trip.

Frequency & Delay

- 51:** DC short delay
 - 52:** DC long delay
 - 53:** DC motor start
 - 59:** DC 125% instant trip
 - 61:** 50/60Hz short delay
 - 62:** 50/60Hz long delay
 - 63:** 50/60Hz motor start
 - 69:** 50/60Hz 125% instant trip
- For addition of inertial delay, add an "F" to any delay numeral.
*Not available above 100 amps.

Rated Current

Use three numbers to print (.050 or 1.50 or 100) Value between .050 amps and 100 amps.

Optional

- A:** Metric thread mounting inserts and terminals
- B:** Standard Barrier
- F:** 240V 50/60Hz
- G:** Handle guard, (available in ZX, BX and snap-in versions only)
- K:** 1/4 - 20 stud (M6 stud when -A option is selected) (<=70A requires -K, if >70A do not use -K)
- L:** Handle lock
- M:** Handle in opposite pole
- P:** Snap-in face plate adapter
- U:** 120/240Vac, 5000 A.I.C., 70A max. 2 pole only with barrier (TUV 250Vac)
- V:** 125VDC
- X:** Handle guard with no actuate "off" feature (see detail C)
- Z:** "Z" Barrier
- 1:** Silver 5/16" (.312") bullet

- Notes:
- One or more descriptions may be used as required.
 - When this decision is not used, decision 7 may be substituted and U.S. thread will be supplied.
 - If (M5 or M6) studs are required, use "A" only on an LELK.

LEL Toggle Handle Color Selection

- 01:** Black w/ white markings
 - 11:** Yellow w/ black markings
 - 21:** Red w/ white markings
 - 91:** White w/ black markings
- See alternate 7th Decision for ZX and BX Rocker Handles.

Rocker Handle Color, Indicator Color and Marking Selection (See Notes)

LELZX & LMLZX Rocker Handle (Single Rocker Color)

Rocker Handle Color	Indicating Color	Marking Color	Indicates:	Vertical Mounting		Horizontal Mounting	
				On-Off	I-O Fig.3	On-Off	I-O Fig.6
Black	N/A	White	N/A	-03		-06	
Red	N/A	White	N/A	-23		-26	
Grey	N/A	Black	N/A	-43		-46	A
Orange	N/A	Black	N/A	-53		-56	
White	N/A	Black	N/A	-93		-96	

LELZX & LMLZX Rocker Handle (Dual Rocker Color)

Black	White	White	On	-A3		-A6	
Black	Red	White	On	-B3		-B6	
Black	Green	White	On	-C3		-C6	
Black	White	White	Off	-F3		-F6	A
Black	Red	White	Off	-G3		-G6	
Black	Green	White	Off	-H3		-H6	
Black	White	White	On	-J3		-J6	
Black	Red	White	On	-K3		-K6	B
Black	Green	White	On	-L3		-L6	

LELBX Rocker Handle (Dual Rocker Color)

Black	White	White	Off	-M3		-M6	
Black	Red	Red	Off	-N3		-N6	
Black	Green	Green	Off	-P3		-P6	
Black	Yellow	Yellow	Off	-R3		-R6	C

Notes: A. Bezels of IALBX, IULBX, IELB, IELBX are black.

B. Consult factory for other marking options.

T = IEC and CCC Approved

The shaded areas denote TUV approval options. This approval requires the addition of a T or V at the end of the part number. The suffix will be added to any part number formed entirely of shaded decisions. If non-shaded areas are selected, the unit will not be TUV approved, but other approvals still apply.

C = CCC Approved

The approval requires the addition of a C at the end of the part number. The unit will not be TUV Approved.

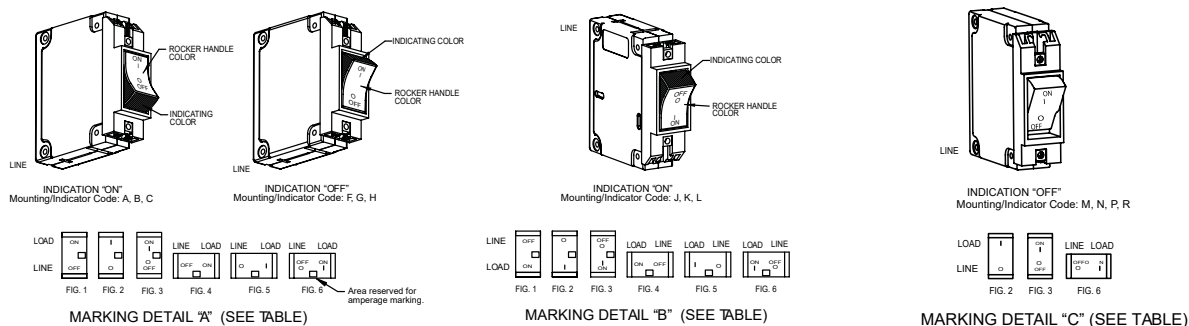

Notes: The LEL family of circuit breakers are designed to meet 8mm creepage and clearance requirements for installation Category 111, pollution degree 3, Case A as measured in IEC 664. Intended for use in equipment designed to comply with IEC 380, 435, 601.



CEL - 1 - 1REC4 - 51 - 20.0 - A - 01 - V

Type

- CEL:** One handle per unit, UL489A Listed
- CELH:** One handle per pole, UL489A Listed
- CML:** Single pole only, one handle per unit mid-trip construction, UL489A Listed
- CMLH:** One handle per pole mid-trip construction, UL489A Listed
- CELZX:** One handle per unit, rocker handle, UL489A Listed
- CMLZX:** Single pole only, one handle per unit, rocker handle w/ RLS aux switch, mid-trip construction, UL489A Listed
- CELBX:** One handle per unit, flat rocker handle, UL489A Listed
- CMLBX:** Single pole only, one handle per unit, flat rocker handle w/ RLS aux switch, mid-trip construction, UL489A Listed

Terminal

- Standard screw terminal, no designation required
- K:** Stud terminals
- B:** Bullet terminals

Poles

- 1:** Single pole
- 11:** Two pole
- 111:** Three pole

Internal Configuration

- 1:** Series
 - 1REC4:** Series with auxiliary switch .110 quick connect
 - 1REC5:** Series with auxiliary switch .187 quick connect
 - 1RS4**:** Series with alarm switch, electrical trip, .110 quick connect
 - 1RLS4**:** Series with alarm switch, electrical trip, .110 quick connect*
- * Only one auxiliary switch is normally supplied on two and three pole units switch is located in the right hand pole (viewed from terminal end). Note, aux switch followed by "R" indicates reverse mount option
- ** Not available for 125 amp single pole

Frequency & Delay

- 51:** DC short delay
 - 52:** DC long delay
 - 53*:** DC motor start
 - 59:** DC 125% instant trip
- For addition of inertial delay, add an "F" to any delay numeral. Example: -51F
- *Not available above 100 amps.

Rated Current

Use three numbers in build (.050 or 1.50 or 100).
 Required value between .050 amps minimum and 125 amps maximum.

Optional

- A:** Metric thread mounting inserts and terminals
- B:** Barrier
- G:** Handle guard, (available in ZX, BX and snap-in versions only)
- K:** 1/4-20 Stud (M6 stud when metric option -A selected) 50A requires -K, >50A do not use -K
- P:** Snap-in face plate adapter
- T:** 80VDC, 10000AIC, (required over 50A)
- V:** 125VDC
- 1:** Silver 5/16" (.312") bullet

Notes:

- One or more descriptions may be used as required.
- When this decision is not used, decision 7 may be substituted and U.S. thread will be supplied.

LEL Toggle Handle Color Selection

- 01:** Black w/ white markings
 - 11:** Yellow w/ black markings
 - 21:** Red w/ white markings
 - 31:** Blue w/ white markings
 - 41:** Green w/ white markings
 - 61:** Orange w/ black markings
 - 91:** White w/ black markings
- See alternate 7th Decision for ZX and BX Rocker Handles.

Rocker Handle Color, Indicator Color and Marking Selection (See Notes)

LELZX & LMLZX Rocker Handle (Single Rocker Color)

Rocker Handle Color	Indicating Color	Marking Color	Indicates:	Vertical Mounting		Horizontal Mounting		Marking Detail
				On-Off	I-O Fig.3	On-Off	I-O Fig.6	
Black	N/A	White	N/A	-03		-06		
Red	N/A	White	N/A	-23		-26		
Grey	N/A	Black	N/A	-43		-46		A
Orange	N/A	Black	N/A	-53		-56		
White	N/A	Black	N/A	-93		-96		

LELZX & LMLZX Rocker Handle (Dual Rocker Color)

Black	White	White	On	-A3		-A6		
Black	Red	White	On	-B3		-B6		
Black	Green	White	On	-C3		-C6		
Black	White	White	Off	-F3		-F6		A
Black	Red	White	Off	-G3		-G6		
Black	Green	White	Off	-H3		-H6		
Black	White	White	On	-J3		-J6		
Black	Red	White	On	-K3		-K6		B
Black	Green	White	On	-L3		-L6		

LELBX Rocker Handle (Dual Rocker Color)

Black	White	White	Off	-M3		-M6		
Black	Red	Red	Off	-N3		-N6		
Black	Green	Green	Off	-P3		-P6		C
Black	Yellow	Yellow	Off	-R3		-R6		

Notes: A. Bezels of IALBX, IULBX, IELB, IELBX are black.

B. Consult factory for other marking options.

V, T = TUV and CCC Approved

The shaded areas denote TUV approval options. This approval requires the addition of a T or V at the end of the part number. The suffix will be added to any part number formed entirely of shaded decisions. If non-shaded areas are selected, the unit will not be TUV approved, but other approvals still apply.

C = CCC Approved

The approval requires the addition of a C at the end of the part number. The unit will not be TUV Approved.

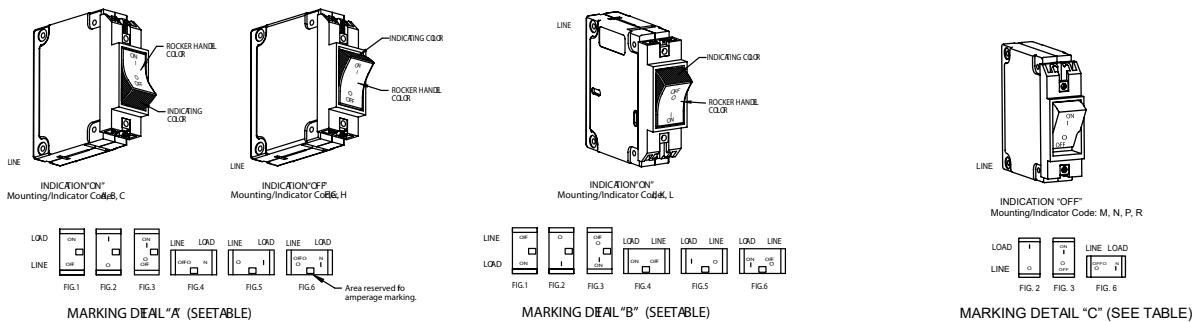



LELHPK **11** - **1REC4** - **51** - **125.** - **A** - **01** - **V**

Type with Stud Terminals

- LELPK:** One handle per unit
 - LMLPK:** One handle per unit, mid-trip
 - LELZXPBK:** One ZX rocker handle per unit (integral mounting)
 - LMLZXPBK:** One ZX rocker handle per unit, mid-trip (integral mounting)
 - LELBXPBK:** One BX rocker handle per unit (integral mounting)
 - LMLBXPBK:** One BX rocker handle per unit, mid-trip (integral mounting)
 - LELHPK:** One handle per pole
 - LMLHPK:** One handle per pole, mid-trip
1. One toggle handle per unit on 125A to 150A units (2-parallel pole)
 2. 175A to 200A (3-parallel pole) requires handle in each pole, "H" selection

Poles

- 11:** Two pole (up to 150 amps)
- 111:** Three pole (160 to 200 amps)

Internal Configuration

- 1:** Series
- 1REC4:** Series with auxiliary switch .110 quick connect
- 1REG4:** Series, aux switch (gold contacts) .110 quick connect
- 1RLS4:** Series with alarm aux switch .110 quick connect, mid-trip only
- 1RLSG4:** Series, alarm aux switch (gold contacts), .110 quick connect, mid-trip only
- 1RS4:** Series with alarm aux switch .110 quick connect
- 1REC5:** Series with aux switch .187 quick connect
- 1RLS5:** Series with alarm aux switch .187 quick connect, mid-trip only
- 1RS4:** Series with alarm aux switch .187 quick connect
- 1RS5:** Series with alarm aux switch .187 quick connect, mid-trip

Frequency & Delay

- 51:**
DC 125% short delay (125 to 150 amp)
DC 135% short delay (160 to 200 amp)
 - 52:**
DC 125% long delay (125 to 150 amp)
DC 135% long delay (160 to 200 amp)
 - 59:**
DC 125% instant trip (125 to 150 amp)
DC 135% instant trip (160 to 200 amp)
- For addition of inertial delay, add an "F" to any delay option. Example: - 59 becomes -59F

Rated Current

125. 130. 135. 150. 175. 200.
Additional ratings available.

Optional

- A:** Metric thread mounting inserts and terminals
 - G:** Snap-in mounting plate adapter with handle guard (ZX, BX & snap-in only)
 - X:** Handle guard with no actuate off feature (BX only, no mid-trip)
 - P:** Snap-in face plate adapter
- Notes:
1. One or more descriptions may be used as required.
2. When this decision is not used, decision 7 may be substituted and U.S. thread will be supplied.

LEL Toggle Handle Color Selection

- 01:** Black w/ white markings
 - 11:** Yellow w/ black markings
 - 21:** Red w/ white markings
 - 91:** White w/ black markings
- See LEL alternative 7th decision for ZX & BX rocker handles

V, T = TUV and CCC Approved

The shaded areas denote TUV approval options. This approval requires the addition of a T or V at the end of the part number. The suffix will be added to any part number formed entirely of shaded decisions. If non-shaded areas are selected, the unit will not be TUV approved, but other approvals still apply.

C = CCC Approved

The approval requires the addition of a C at the end of the part number. The unit will not be TUV Approved.



CELHPK **11** - **1REC4** - **51** - **125.** - **A** - **01** - **V**

Type with Stud Terminals

- CELP:** One toggle handle per unit
- CELHP:** One toggle handle per pole
- CMLHP:** One toggle handle per pole, mid-trip construction
- CELZXP:** One rocker handle per unit
- CELBXP:** One flat rocker handle per unit
- 1. One toggle handle per unit is available only on 101A to 200A (two parallel pole construction)
- 2. 201A to 250A (three parallel pole constructions) require handles in each pole, "H" version first decision
- 3. Unit supplied with bullet terminals will not have buss bar installed, unless requested, buss bar supplied standard to 150A only.
- 4. One handle per unit is available for 100A to 200A (two parallel pole constructions) and 201A to 250A (three pole constructions) (ZX & BX versions only)
- 5. 400 amps available with toggle handles only

Poles

- 11:** Two pole (up to 150 amps)
- 111:** Three pole (160 to 200 amps)
- 1111:** Four pole (400 amps)

Internal Configuration

- 0:** Switch only
- 1:** Series
- 1REC4:** Series with auxiliary switch .110 quick connect
- 1RLS4*:** Series with alarm aux switch .110 quick connect, mid-trip only
- 1RS4*:** Series with alarm aux switch .110 quick connect
- 1REC5:** Series with aux switch .187 quick connect
- 1RLS5*:** Series with alarm aux switch .187 quick connect, mid-trip only
- 1RS4:** Series with alarm aux switch .187 quick connect
- 1. Only one auxiliary switch is normally supplied on two and three pole units. Switch is located in the right hand pole (viewed from terminal end panel mount position).
- 2. When more than one aux. switch is required, change the 1 (of the 1REC4) to 2 or 3. If switches are mixed, then use "2R" or 3R".
- * Not available at 400 amps.

Frequency & Delay

- 51:**
DC 125% short delay (101 to 150 amp)
DC 135% short delay (160 to 250 amp)
- 52:**
DC 125% long delay (101 to 150 amp)
DC 135% long delay (160 to 250 amp)
- 53:**
DC 125% motor start (101 to 150 amp)
DC 135% motor start (160 to 250 amp)
- 59:**
DC 125% instant trip (101 to 150 amp)
DC 135% instant trip (160 to 250 amp)

Rated Current

125. 130. 135. 150. 175. 200. 400.
Additional ratings available.

Optional

- A:** Metric thread mounting inserts and terminals
- B:** Barrier
- G:** Snap-in mounting plate adapter with handle guard (ZX, BX & snap-in only)
- X:** Handle guard with no actuate off feature (BX only, no mid-trip)
- 1:** Silver 5/16" (.312") bulletNotes:
1. One or more descriptions may be used as required.
2. When this decision is not used, decision 7 may be substituted and U.S. thread will be supplied.

LEL Toggle Handle Color Selection

- 01:** Black w/ white markings
- 11:** Yellow w/ black markings
- 21:** Red w/ white markings
- 91:** White w/ black markings
- See LEL alternative 7th decision for ZX & BX rocker handles

T = TUV and CCC Approved

The shaded areas denote TUV approval options. This approval requires the addition of a T or V at the end of the part number. The suffix will be added to any part number formed entirely of shaded decisions. If non-shaded areas are selected, the unit will not be TUV approved, but other approvals still apply.



AGENCY APPROVALS & CERTIFICATIONS

AGENCY APPROVALS - IAL/IUL/IEL									
Voltage	Frequency (Hz)	Phase	Min. Poles	TC	OL	UL/CSA	VDE (amps)	UL 1077 & CSA (AIC)	VDE (AIC)
65	DC	-	1	1	1	.02-100	.10-70	U2, 7500	4000
65(4)	DC	-	1	1	1	.02-100	-	U2, 3000	-
65(4)	DC	-	1	1	1	.02-50	-	U2, 5000	-
65	DC	-	2**	2	1	101-150	-	U2, 7500	-
80	DC	-	1	1	1	.02-70	.10-50	U2, 7500	4000
80	DC	-	1	1	1	70.1-100	-	U2, 5000	-
80	DC	-	2	1	1	101-150	-	U1, 10000	-
80	DC	-	3	1	0	251-300	-	U2, 7500	-
125	DC	-	2	1	0	.02-100	-	U2, 5000	-
250	DC	-	2+	1	0	.02-50	-	U1, 5000	-
300	DC	-	3++	1	0	.02-50	.10-50	U2, 1000	5000
125	50/60	1	1	1	0	.02-70	-	U2, 5000	-
125	50/60	1	1	1	1	.02-100	-	U1, 3000	-
125(5)	50/60	1	1	1	1	.02-100	-	U3, 1500	-
120/240	50/60	1	2	2	1	.02-100	-	U1, 2000	-
125/250(5)	50/60	1	2 only	1	1	.02-100	-	U3, 1500	-
240	50/60	1&3	1	1	0	.02-70	-	U1, 2000	-
240	50/60	3	2	1	1	.02-100	-	U2, 2000	-
250	50/60	3	1	1	1	.02-50	.10-100	U2, 3000	2000
250	50/60	3	1	1	1	.02-50	.10-100	C2, 5000(1)	2000
250	50/60	1	1	1	1	.02-50	.10-100	C2, 5000(2)	2000
250	50/60	3	2	1	0	.02-80	.10-100	U1, 1000	2000
250	50/60	3	1	1	0	.02-60	.10-100	U1, 5000	2000
250(5)	50/60	3	3 only	1	1	.02-100	-	U3, 2000	-
277	50/60	1	1	1	1	.02-50	-	U2, 2000	-
277	50/60	1&3	1	2	1	.02-50	-	C2, 5000(1)	-
240/415	50/60	3	2	2	0	.02-50	.10-50	U2, 2000	2000
240/415	50/60	1	2	2	0	.02-50	.10-50	C2, 5000(1)	2000
277/480	50/60	3	2	2	1	.02-30	-	U2, 2000	-
277/480	50/60	3	2	2	1	.02-50	-	U2, 1200	-
277/480	50/60	3	2	1	1	.02-30	-	C2, 5000(3)	-
277/480	50/60	1&3	2	1	0	.02-50	-	C2, 5000(3)	-
480	50/60	1&3	2	1	1	.02-30	-	C2, 5000(3)	-
480	50/60	3	2	1	0	.02-50	-	C2, 5000(3)	-
250	400	1&3	1	2	1	.02-50	-	U2, 1500	-

AGENCY APPROVALS - CEL/CELP (COMMUNICATIONS)							
Voltage	Frequency (Hz)	Phase	Min. Poles	UL/CSA	VDE (amps)	UL 489A (AIC)	VDE (AIC)
65	DC	-	1	.05-50	-	7500	-
65	DC	-	2**	101-150	-	50000	-
80	DC	-	1	.05-100	-	50000	-
80	DC	-	2**	101-200	-	10000	-
80	DC	-	3**	201-250	-	10000	-
125	DC	-	1	.05-70	-	5000	-
80	DC	-	1	15.1-125	-	10000	-

AGENCY APPROVALS - IDL/IDL (MARINE)									
Voltage	Frequency (Hz)	Phase	Min. Poles	TC	OL	UL/CSA	VDE (amps)	UL 1077 & CSA (AIC)	VDE (AIC)
48	DC	-	1	1	1	.02-100	-	U1, 5000	-
48	DC	-	2**	1	1	101-150	-	U1, 5000	-
65	DC	-	1	1	1	.02-60	-	U1, 1000	-
80	DC	-	1	1	1	.02-100	-	U2, 1500	-
125	50/60	1	1	1	1	.02-100	-	U 1, 1500	-
250	50/60	1	2	1	1	.02-100	-	U2, 1500	-
250	50/60	1&3	1	1	1	.02-60	-	U1, 1000	-

AGENCY APPROVALS - IULQ (TAPPED COIL)									
Voltage	Frequency (Hz)	Phase	Min. Poles	TC	OL	UL/CSA	VDE (amps)	UL 1077 & CSA (AIC)	VDE (AIC)
125/250	50/60	1	1	1	0	2/1-30/15	-	C2, 5000(1)	-

AGENCY APPROVALS - IULD (DUST SEALED)									
Voltage	Frequency (Hz)	Phase	Min. Poles	TC	OL	UL/CSA	VDE (amps)	UL 1077 & CSA (AIC)	VDE (AIC)
250	50/60	1&3	1	1	1	.02-100	-	C2, 5000(3)	-
277	50/60	1	1	1	1	.02-30	-	C2, 5000(3)	-

AGENCY APPROVALS - LEL/LELHP							
Voltage	Frequency (Hz)	Phase	Min. Poles	UL/CSA	VDE (amps)	UL489 (AIC)	VDE (AIC)
65	DC	-	1	.05-50	-	7500	-
65	DC	-	2**	101-150	-	50 000	-
65	DC	-	3**	175-200	-	50000	-
80	DC	-	1	.05-100	.10-100	10000	2000
80	DC	-	1	.05-100	-	50000	-
80	DC	-	2**	125-150	125-150	10000	2000
80	DC	-	3**	175-200	151-200	10000	2000
125	DC	-	1	.05-70	.05-70	5000	3000
125/250	DC	-	2	.05-50	-	5000	-
125	50/60	1&3	1	.05-40	-	10000	-
125	50/60	1&3	1	.05-50	.10-50	5000	2000
120/240	50/60	1	2	.05-60	.10-50	5000	2000
240	50/60	1&3	1	.05-20	-	5000	-

AGENCY APPROVALS - CELHP							
Voltage	Frequency (Hz)	Phase	Min. Poles	UL/CSA	VDE (amps)	UL 489A (AIC)	VDE (AIC)
80	DC	-	4	400	-	10000 AIC (UL489A)	-

Notes:
 ** Paralleled poles; + 2 poles in series; ++ 3 poles in series; (1) With 125 A max. series fuse; (2) Series combination with 209 or 229 series (100 A max.); (3) With 100 A max. series fuse; (4) With blocked vent construction (5) Non-standard construction. "Fit for further use" approval

General notes:

- All supplementary protectors are of the overcurrent (OC) type
 - The family of protectors has been evaluated for end use application for use groups (UG) A, B, C and D
 - The terminals (FW) are suitable for factory wiring only (0)
 - The maximum voltage ratings for which the protectors have been tested are shown in the chart
 - The current is the ampere range that the protectors have been tested
 - The tripping current (TC) for all of the protectors is either "1" (in the range of 125% to 135% of ampere rating) or "2" (more than 135% of ampere rating)
 - The overload rating (OL) – designates whether the protector has been tested for general use or motor starting applications.
- 0 – tested at 1.5 times amp rating for general use
 1 – tested at 6 times AC rating or 10 times DC rating for motor starting
- The short circuit current rating (SC) – The short circuit rating in amperes following a letter and number designating the test conditions and any calibration following the short circuit test is defined below:
- C – Indicates short circuit test was conducted with series overcurrent protection
 U – Indicates short circuit test was conducted without series overcurrent protection
 1 – Indicates a recalibration was not conducted as part of the short circuit testing
 2 – Indicates a recalibration was performed as part of the short circuit testing
 3 – Indicates recalibration was performed along with the dielectric and voltage withstand for "Suitable for Further Use" rating



WARNINGS



RISK OF MATERIAL DAMAGE AND HOT ENCLOSURE

- The product's side panels may be hot, allow the product to cool before touching
- Follow proper mounting instructions including torque values
- Do not allow liquids or foreign objects to enter this product

Failure to follow these instructions can result in serious injury, or equipment damage.



HAZARD OF ELECTRIC SHOCK, EXPLOSION OR ARC FLASH

- Disconnect all power before installing or working with this equipment
- Verify all connections and replace all covers before turning on power

Failure to follow these instructions can result in death or serious injury.

Sensata Technologies, Inc. ("Sensata") data sheets are solely intended to assist designers ("Buyers") who are developing systems that incorporate Sensata products (also referred to herein as "components"). Buyer understands and agrees that Buyer remains responsible for using its independent analysis, evaluation and judgment in designing Buyer's systems and products. Sensata data sheets have been created using standard laboratory conditions and engineering practices. Sensata has not conducted any testing other than that specifically described in the published documentation for a particular data sheet. Sensata may make corrections, enhancements, improvements and other changes to its data sheets or components without notice.

Buyers are authorized to use Sensata data sheets with the Sensata component(s) identified in each particular data sheet. HOWEVER, NO OTHER LICENSE, EXPRESS OR IMPLIED, BY ESTOPPEL OR OTHERWISE TO ANY OTHER SENSATA INTELLECTUAL PROPERTY RIGHT, AND NO LICENSE TO ANY THIRD PARTY TECHNOLOGY OR INTELLECTUAL PROPERTY RIGHT, IS GRANTED HEREIN. SENSATA DATA SHEETS ARE PROVIDED "AS IS". SENSATA MAKES NO WARRANTIES OR REPRESENTATIONS WITH REGARD TO THE DATA SHEETS OR USE OF THE DATA SHEETS, EXPRESS, IMPLIED OR STATUTORY, INCLUDING ACCURACY OR COMPLETENESS. SENSATA DISCLAIMS ANY WARRANTY OF TITLE AND ANY IMPLIED WARRANTIES OF MERCHANTABILITY, FITNESS FOR A PARTICULAR PURPOSE, QUIET ENJOYMENT, QUIET POSSESSION, AND NON-INFRINGEMENT OF ANY THIRD PARTY INTELLECTUAL PROPERTY RIGHTS WITH REGARD TO SENSATA DATA SHEETS OR USE THEREOF.

All products are sold subject to Sensata's terms and conditions of sale supplied at www.sensata.com SENSATA ASSUMES NO LIABILITY FOR APPLICATIONS ASSISTANCE OR THE DESIGN OF BUYERS' PRODUCTS. BUYER ACKNOWLEDGES AND AGREES THAT IT IS SOLELY RESPONSIBLE FOR COMPLIANCE WITH ALL LEGAL, REGULATORY AND SAFETY-RELATED REQUIREMENTS CONCERNING ITS PRODUCTS, AND ANY USE OF SENSATA COMPONENTS IN ITS APPLICATIONS, NOTWITHSTANDING ANY APPLICATIONS-RELATED INFORMATION OR SUPPORT THAT MAY BE PROVIDED BY SENSATA.

Mailing Address: Sensata Technologies, Inc., 529 Pleasant Street, Attleboro, MA 02703, USA.

CONTACT US

Americas

508-236-2551
electrical-protection-sales@
sensata.com

Europe, Middle East & Africa

+31743578156
info-sse@list.sensata.com

Asia Pacific

sales.isasia@list.sensata.com
China +86 (21) 2306 1500
Japan +81 (45) 277 7117
Korea +82 (31) 601 2004
India +91 (80) 67920890
Rest of Asia +886 (2) 27602006
ext 2808