



more sensors, more solutions



Occupancy Solution Kit: Total Count (TC)

Kit Contents



Q45 Sensor Pair
includes AA batteries

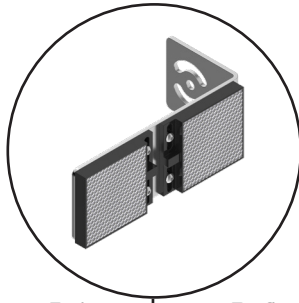

Reflector Pair
pre-mounted on bracket



TL70 Wireless Indicator
includes bracket and power
supply

Not Shown - mounted inside building



DXM Controller



Direct Select Operator Interface
includes C battery



Power Supply

Tools Needed

Tape measure
Phillips screwdriver

Not Included

1/4"-20 mounting fasteners

How it Works

The Occupancy Solution Kit works by monitoring the number of people into and out of an area. User defined Alert levels trigger a red indicator on the Operator interface and indicator light to show that the area occupancy has been exceeded. Occupancy levels reset automatically every night at 2 AM Central Time.

Total Count (TC) Solution Kits are configured to monitor between one and four doors out of the box. The Q45 Sensor Pairs monitor people entering and exiting the area, for up to four doors, and give a total count of people inside. The Operator Interface displays the number of people in the area and allow for employee adjustments to the occupancy count. Indicator lights display if additional people are allowed to enter the area or if they are required to wait until the occupancy level drops below a user-defined limit.

Multiple Count (MC) Solutions Kits are available when a user requires individual door Occupancy Limits.

The **DXM Controller** sets the user-defined occupancy levels. The display shows the current occupancy level and other system metrics.

The Occupancy Limit defines the area's maximum capacity. The Occupancy Warning value defines a warning level below the Occupancy Limit to indicate when the occupancy is close to the area's capacity. Reaching the Occupancy Warning value triggers faster reporting.



Set the Occupancy Warning below the Occupancy Limit.

Mount the DXM Controller in a secure location outside of any metal cabinets or enclosures.



The **Direct Select® Operator Interface** displays the total count of people in the monitored area.

The indicator is off when the occupancy level is below the warning limit. The indicator turns yellow when the warning limit has been reached. The indicator turns red when the Occupancy limit has been reached.

Use the  (up) and  (down) buttons to manually make corrections to the total count by increasing and decreasing the count to reflect the actual occupancy level. The display may take up to two seconds to update the manual adjusts. The  (back) button resets the entire system back to 0 occupancy.

The Operator Interface can be mounted near each monitored door or can be held by an operator to actively monitor the occupancy level.



The **Q45 Sensor Pair** detects whether a person is entering or exiting the monitored area. The Sensor Pair comes with two sensors, Sensor A and Sensor B.

Mount the Q45 Sensor Pair according to Banner's suggested mounting instructions on page 6.

The **Indicator Light** alerts people when entering into the area is allowed (green) and when entering is no longer allowed (red).

An optional yellow segment can be added to display the Occupancy Warning.

Mount the Indicator Light indoors when possible and mount so that people entering the monitored area are able to see the occupancy status.

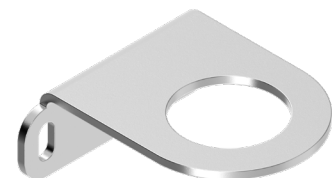

Indicator Light bracket, model LMB30LP (included with kit)

Set Up Your Hardware

1

Supply power to all devices

The Occupancy Monitoring Kit arrives with all necessary power sources needed to get the system operating quickly. This includes lithium batteries for the Q45 Sensor Pair and Direct Select Operator Interface, and a DC power supply for the DXM Controller and TL70 Wireless Indicator Light.

Supply Power to the DXM Controller

Plug the power supply into the DXM Controller, aligning the keys in the connector, and hand tighten. Plug the power supply into a power outlet using the appropriate regional wall adapter.



Supply Power to the Q45 Sensor Pair

The Q45 Sensor Pair comes with two sensors: Sensor A and Sensor B. Sensor A has a metal connector on the bottom. Sensor B has a six-inch cable. Complete steps 1 through 6 below for both Sensor A and Sensor B.



1. Loosen the clamp plate with a small Phillips screwdriver and lift the cover.



2. Using a small Phillips screwdriver, insert the tip into the small hole in the battery holder and pry up the battery holder. Slide the battery board up and out of the housing.



3. Insert the AA lithium batteries and verify the positive and negative terminals of each battery align to the positive and negative terminals. Caution: There is risk of damage if the batteries are installed incorrectly.



4. Slide the battery board back into the housing.



5. If the indicator LEDs do not automatically begin flashing, turn on the sensor by pressing and holding the button for five seconds until the LED to the right of the button flashes.



6. Close the cover and gently tighten the clamp plate with the small Phillips screwdriver.

Supply Power to the Direct Select Operator Interface





1. Unscrew the four corner screws with a Phillips screwdriver and open the Operator Interface.



2. Insert the 3.6 V lithium battery. Verify the battery's positive and negative terminals align to the positive and negative terminals as marked.

Caution: There is risk of damage if the batteries are installed incorrectly.



3. If the indicator LED does not automatically begin flashing, turn on the Operator Interface by pressing and holding  and  together for five seconds or until the small light starts flashing red.

4. Reassemble the Node and tighten the four corner screws. Do not over-tighten.

Mount and Supply Power to the TL70 Wireless Indicator Light



1. Position the Indicator Light on the bracket so that the icons are facing the desired orientation.

Secure with the supplied lock nut. Hand tighten only.



2. Connect the power supply to the Indicator Light, aligning the keys in the connector. Hand tighten.

3. Connect the power supply into a power outlet using the appropriate regional wall adapter.

2

Mount the System Components

Mounting hardware is not included with the Occupancy Solutions Kit. Banner recommends using ¼-20 mounting bolts, self tapping screws, magnetic mounts, or hardware that is compatible with the mounting surface.

Do not mount any radios inside metal enclosures. Metal around the radios can reduce wireless signal strength.



Mount the DXM Controller in a secure location, outside of any metal cabinets or enclosures.

The DXM Controller has four mounting holes. Use ¼-20 mounting bolts or self tapping screws to secure the controller to a rigid surface.



Mount the Indicator Light indoors when possible and mount so that people entering the monitored area are able to see the occupancy status.

Mount the indicator light using the supplied bracket and ¼-20 mounting bolts, self tapping screws, or optional magnetic mounts listed at the end of this document.



The Operator Interface can be mounted near each monitored door, in a central supervisory location, or can be held by an employee to actively monitor the occupancy level.

Mount the Operator Interface to a rigid surface using the mounting holes and ¼-20 bolts, self tapping screws, or optional magnetic mounts listed at the end of this document.

How you mount your sensor varies based on the application requirements. User-provided custom mounting fixtures may be required in cases where the supplied brackets are not compatible with the installation location. Contact your local distributor or Banner Engineering's Technical Support team at 1-800-203-5616 for more options or refer to our Troubleshooting section on page 9.

Sensor A has the integrated 5-pin male quick disconnect connector



Sensor B has the integrated 6-inch cable with a female quick disconnect connector



When mounting the Q45 Sensor Pairs on the inside of the door:

1. Place Sensor A closest to the L section of the mounting bracket.
2. Place Sensor B on the remaining mounting hole.
3. Thread the black locknut onto the bases and hand tighten.
4. Connect the cable from Sensor B to Sensor A, aligning the key in the connector on the cable with the key on the connector on Sensor A. Hand tighten only.

Note: Sensor A has a 5-pin male connector on the bottom. Sensor B has the cable.

Mounting Recommendations

- Mount the sensors at a minimum height of 1 meter (40 inches) to avoid the potential for miscounts. Mounting the sensor at a height below 1 meter (40 in) may result in double counts by detecting arm or leg motion.
- Mount the sensors no farther than 3.66 m (12 ft) away from the reflectors for optimal performance. This may vary by door application/customer need.
- Mount the sensors 76 mm (3 in) away from each other (center to center) when you are not using the supplied mounting brackets.

Sliding Doors

For occupancy monitoring in areas with sliding doors, Banner recommends mounting the devices on the inside of the door as close as possible to the door.

Avoid mounting the sensors in areas where people will stand and may block the sensors.

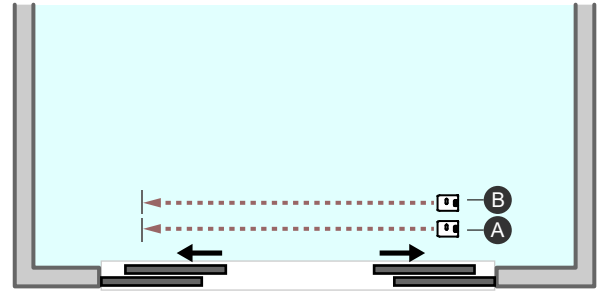

Outward Opening Doors

For occupancy monitoring in areas with outward opening doors, Banner recommends mounting the devices on the inside of the door as close as possible to the door.

Avoid mounting the sensors in areas where people will stand and block the sensors.

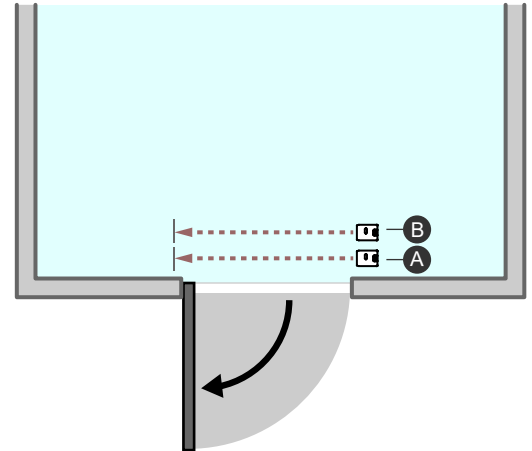

Inward Opening Doors

For occupancy monitoring in areas with inward opening doors, Banner recommends mounting the devices on the inside of the door, far enough from the door that the door does not trip the sensor pair when opening.

Two mounting options are shown: I and II. Mounting I is preferred to keep the sensors and reflectors from obstructing the area. Mounting II is possible when no other mounting options are available.

Avoid mounting the sensors in areas where people will stand and block the sensors.

Banner recommends using accessory mounting stands if a rigid mounting surface is not available.

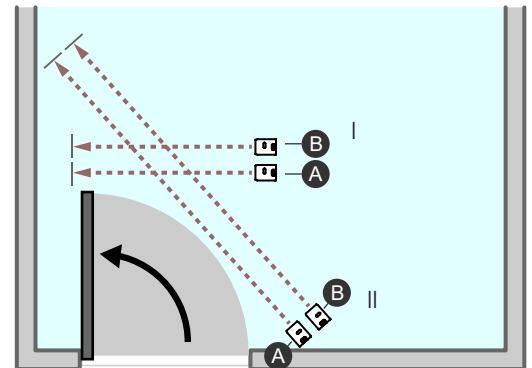

L-type Doors

For occupancy monitoring in areas with an L-type door configuration, Banner recommends mounting the devices on the inside of the door so that the door does not activate the sensors when it is opened.

Two mounting options are shown: I and II. Mounting I is preferred to keep the sensors and reflectors from obstructing the area. Mounting II is possible when no other mounting is available.

Avoid mounting the sensors in areas where people will stand and block the sensors.

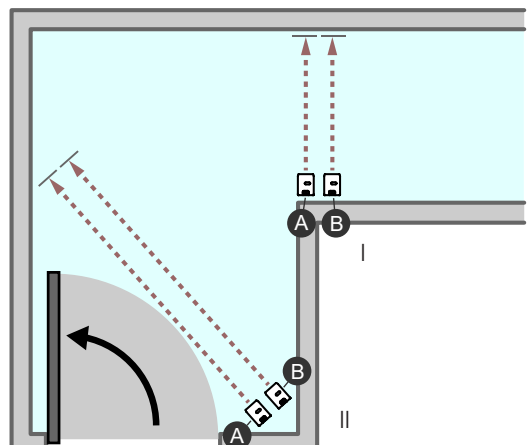

Disclaimer: Do not place in an area where the sensor pairs may be blocked by people or objects.

3

Align the Sensors

1. Mount the reflectors bracket opposite the sensor pair and at the same mounting height.
2. Begin with the sensors facing outward and loosen the locknut on the base of the sensors. See image below for sensor starting position (gray).
3. Unscrew the lid of Sensor A and press the button to enter optical alignment mode. The front of the sensor will show a bright red LED, which is used to align the sensor to the reflectors. Repeat this process for Sensor B.
4. From behind Sensor A, rotate the sensor inward towards the reflector until the amber alignment indicator turns on.
5. See the alignment image for the aligned position (green). Repeat this process for Sensor B.
6. Confirm optical alignment by blocking reflector A with a hand or opaque object at the reflector. The amber alignment indicator on sensor A should turn off. If blocking Reflector A does not turn off the amber alignment indicator on Sensor A, it is likely that Sensor A is seeing Reflector B. Rotate Sensor A outward until it is seeing Reflector A. If the sensors will not optically align to their reflector, refer to the Troubleshooting section for more information or contact your local distributor or Banner Engineering for assistance.
7. Confirm optical alignment by blocking reflector B with a hand or opaque object at the reflector. The amber alignment indicator on sensor B should turn off. If blocking Reflector B does not turn off the amber alignment indicator on Sensor B, it is likely that Sensor B is seeing Reflector A. Rotate Sensor B outward until it is seeing Reflector B. If the sensors will not optically align to their reflector, refer to the Troubleshooting section for more information or contact your local distributor or Banner Engineering for assistance.

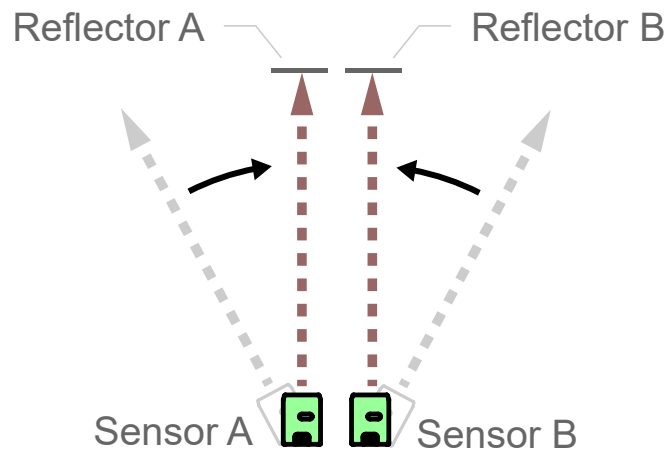
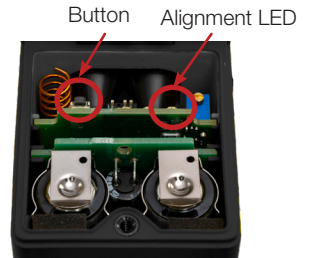

Note: From behind the Sensor Pair, Sensor A may be either to the left or to the right of Sensor B. This will depend on whether the Sensor Pair is mounted on the left or the right of a door. The alignment process will be the same for either position.

Define Your Alert Levels

Set Up the Warning and Alarm Settings Using the DXM Controller Display



This Occupancy Solution Kit is designed to provide visual indication of capacity levels for monitored areas. The Occupancy Limit indicates that the area has exceeded the capacity for people.

The indicator light alerts people attempting to enter that they need to wait until people have left the area before entering. The Occupancy Warning setting is user-defined and indicates when the occupancy level is getting close to the Occupancy Limit. The Occupancy Warning displays as a yellow flashing LED on the Operator interface and enables change of state reporting, which updates the Total Count after every person enters instead of every minute (the default update rate).

Use the Controller's LCD, button keys, and menu system to configure the warnings and alarms.



On the DXM Controller, use the arrow keys to select the **Registers** menu and press **ENTER**.

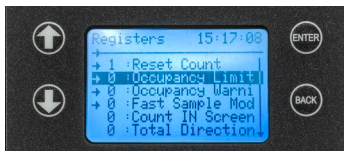

Highlight **Occupancy Limit** and press **ENTER**.

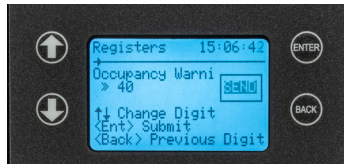

Enter your desired **Occupancy Limit**.

1. Using the up and down arrow buttons, select the first digit for the limit and press **ENTER** to set the first digit.
2. Use the up and down arrows to set the second digit and press **ENTER**.
3. Repeat if you are adding a third digit.
4. Press **ENTER** once more to highlight **SEND** and press **ENTER** to confirm.

The screen should now display the entered **Occupancy Limit**.

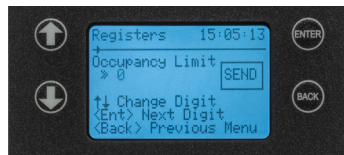

Enter your desired **Occupancy Warning**.

1. Using the up and down arrows, select the first digit for the warning and press **ENTER** to set the first digit.
2. Use the up and down arrows to set the second digit and press **ENTER**.
3. Repeat if you are adding a third digit.
4. Press **ENTER** once more to highlight **SEND** and press **ENTER** to confirm. Note: The **Occupancy Warning** level must be set below the **Occupancy Limit**.

The screen should now display the entered **Occupancy Warning**.

Additional system information is available on the DXM Controller's display.

The installation and configuration of your Solution Kit is complete.

Troubleshooting

Problem	Possible Causes / Solutions
Directional Counts are not changing	Sensors may not be properly aligned. Realign the sensors. Batteries may need to be replaced
Directional Count is opposite of expectation	Sensors pair may be installed in reverse order. Verify sensors A and B are installed in the correct order.
Sensors are double counting	Sensors may not be properly aligned. Realign the sensors. Adjust the sensor height to avoid carts and other objects triggering the sensors.
Sensors missing directional counts or over counting	People may be entering side-by-side, causing the sensors to view a single count instead of two people. People stopping in the middle of the beam path may block others coming through and being counted. If someone walks into the beam path without going through completely, stops, then turns around, the person may not have been counted properly. Recommend instructing people to walk through in a single file pattern and not to stop in front of the sensor's beam path.
Counts reset unexpectedly	Pushing the back arrow on the Operator Interface clears all the counts, similar to the daily reset.
All counts reset overnight	The DXM Controller is programmed to reset all counts at 2 AM Central (observing DST). Contact your local distributor or Banner Engineering's technical support team at 1-800-203-5616 for assistance on changing the reset schedule.
Operator Interface no longer displays the counts	After the DXM Controller is rebooted, a delay of 5 minutes may occur before counts are displayed. The Operator Interface may not be communicating with the DXM Controller. Check the LED above the  (check mark) button. If the LED flashes red, change the positioning of the DXM Controller or Operator Interface so that they are closer to each other. The LED should flash green when the Operator Interface is communicating to the DXM Controller. If the indicator LED does not begin to flash green, contact your local distributor or Banner Engineering's technical support team at 1-800-203-5616.
Sensor's red LED is flashing	Sensors are not communicating with the DXM Controller Change the positioning of the DXM Controller to improve radio signal. The indicator LEDs should flash green when the Sensors are communicating to the DXM Controller. If the indicator LEDs do not begin to flash green, contact your local distributor or Banner Engineering's technical support team at 1-800-203-5616.
Wireless TL70 Indicator Light is not lighting up	After the DXM Controller reboots or cycles power, a delay of up to five minutes may occur before LEDs turn on. The TL70 Wireless Indicator Light may not be communicating with the DXM Controller. Remove the light module above the base by rotating the base counterclockwise and pulling it off of the segments, the lines on the notches should align. Verify the LED is flashing green. If the LED is flashing red, change the positioning of the DXM Controller or TL70 Wireless Indicator Light to improve communication. The LED should flash green when the Indicator Light is communicating to the DXM Controller. If the indicator LEDs do not begin to flash green, contact your local distributor or Banner Engineering's technical support team at 1-800-203-5616.

Optional: Cloud Connectivity

Banner Engineering's Occupancy Solution Kit offers a fast and easy way to gain access to the data and history of the occupancy at your facility. The following section will show you how to configure your gateway over Ethernet and quickly create your solution on the Banner CDS platform. See your data on a default dashboard and create your own visual tools and reporting.

1

Connect the devices using the supplied cables

1. Plug the threaded end of the Ethernet cable to the DXM Controller. Aligning the pins and connect the quick disconnect connector. Hand-tighten only.
2. Connect the RJ45 connector to a local area network device, such as a Wi-Fi router or network modem.

Network Configuration

The Occupancy Solution Kit can be connected to a network using either Static IP or Dynamic IP (DHCP). By default, the Occupancy Solution Kit is configured to use DHCP. Use DHCP when connecting directly to a modem or router. Use a Static IP address if directed to by your IT department.

Setting a Static IP Address

To define a specific IP address of your choosing:

1. On the DXM, use the arrows and move to the **System Config** menu. Press **ENTER**.
2. Use the arrow keys to select the **Ethernet** menu. Press **ENTER**.
3. Highlight the **DHCP** selection and press **ENTER**. Set **DHCP** to **OFF**.
4. The system will request a restart, press **ENTER** to confirm.
5. Follow steps 1 and 2 to enter the **Ethernet** menu. Use the arrow keys to select **IP**. Press **ENTER**.
6. Use the up and down arrows to change the IP address. Press **ENTER** to move to the next octet.
7. Press **ENTER** on the final octet to accept the changes.
8. Cycle power to the DXM1200. The changes are saved on the DXM1200 and the new IP address will be used.

Use the same procedures to set the subnet mask (SN) and default gateway (GW) to match your network requirements. Your IT department can provide these settings if needed.

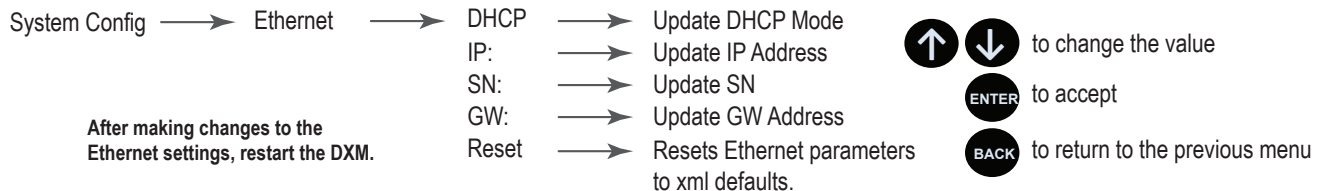

2

Banner Cloud Data Service (Banner CDS)

Navigate to bannercds.com.

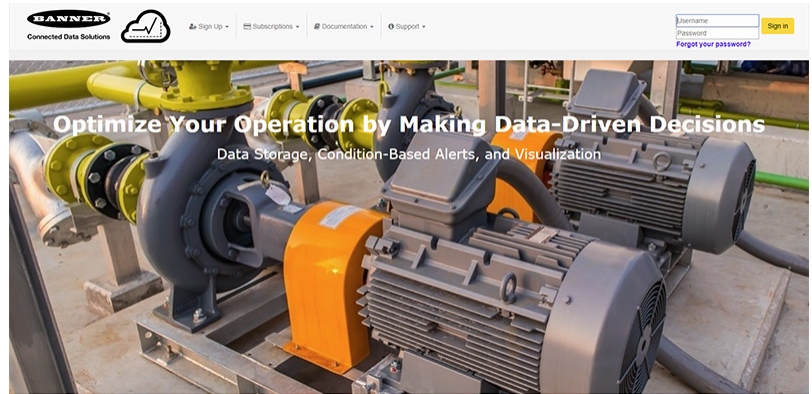

Enter Your Authorization Code

1. Register your account by going to the **Sign Up** menu.
2. Select **Enter Authorization Code**.
3. Enter the requested information. The authorization code is on the Banner Cloud Authorization Code Insert included with the Occupancy Solution Kit.

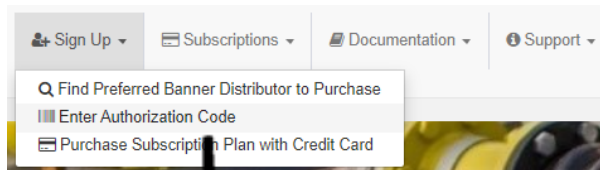

 The image shows a registration form titled "Register your account." It contains several input fields: "Authorization Code:" with a sub-field "Authorization Code"; "Email:" with a sub-field "Email Address"; "Company:" with a sub-field "Company Name"; "User Name:" with a sub-field "User Name"; "Password:" with a sub-field "Password"; and "Verify Password" with a sub-field "Verify Password". A yellow "Sign up" button is at the bottom.

3

Add a New Gateway

After launching the CDS webpage, the **Gateways** screen displays. Use the **Gateways** screen to add the DXM Controller to the Cloud application and generate a Dashboard.

1. Click on **+ New Gateway** (+New Gateway) in the top-right corner of the **Gateways** screen.
2. Name your DXM Controller and enter the Serial Number. The Serial Number can be found using the DXM Controller's LCD. On the DXM's main menu, scroll to **System Info** and then press **ENTER** twice to view the seven-digit serial number at the bottom of the information list.
3. Enter all seven digits into the DXM Serial # entry field on Banner CDS.
4. Verify that **Configuration** is set to **Solutions** and select **Occupancy** for the **Kit Type**. This allows the Banner CDS application to automatically create Dashboard layouts and metrics for the solution. Click **Create** (Create).

The Banner CDS application creates a site for the system and begins searching for a data push from the DXM Controller. The Occupancy Solution Kit is designed to push data once every five minutes to the Cloud.

The DXM Controller could take up to five minutes to complete recognition by the system.

View Dashboard and Set Parameters

After Banner CDS has created the site and detected the DXM Controller, click on [Go to Dashboard](#) (Go to Dashboard). The

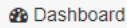

Dashboard (Dashboard) panel appears and indicates the metrics of the Occupancy Solution Kit.

The data on this dashboard will include a historical indication of the Occupancy of the area and a means of updating the Occupancy Limit and Occupancy Warning parameters.

Optional Accessories

To add additional doors to an occupancy monitoring system, order one of each model listed below (900 MHz or 2.4 GHz).

	Sensor Pair	Indicator	Operator Interface	Sensor L Bracket	Reflectors and Bracket	Battery	Battery	Power Supply
900 MHz	DX80N9Q45LPDIR	TL70DXN9GRQ-INOUTKIT	DX80N9DSTS	SMBQ45PC	SMBRPC	BWA-BATT-013 C Battery	BWA-BATT-006 AA Batteries	PSW-24-1
2.4 GHz	DX80N2Q45LPDIR	TL70DXN2GRQ-INOUTKIT	DX80N2DSTS					

900 MHz models are more commonly used in the United States; 2.4 GHz models are required in the EU and many other countries.

Warning Indicator Segment

SG-TL70-Y

- Used with the TL70 Wireless Indicator Light
- Yellow indicator for Warning indication

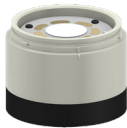

Cellular Modem

SXI-LTE-001

- Used with DXM Controller
- Allows for Cellular Connectivity to the Banner CDS platform

Additional Mounting Options

LMB30LP

- Used with the TL70 Wireless Indicator Light
- Low profile
- 30 mm mounting hole
- 300 series stainless steel
- No fasteners included



SMBAMS30RA

- Used with the Q45 Sensor Pair; one per sensor
- Right-angle SMBAMS series bracket
- 30 mm hole for mounting sensors
- Articulation slots for 90°+ rotation
- 12-gauge (2.6 mm) cold-rolled steel
- No fasteners included



BWA-BK-020 Magnet Mount

- Used with the Direct Select Operator Interface or DXM Controller
- Includes two 80-lb pull rare-earth magnet mounts and two #10-32 × 1 inch screw mounts
- Used on multiple mounting brackets
- 31.75 mm (1.25 inch) diameter
- No fasteners included

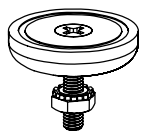

Banner Engineering Corp.

9714 Tenth Avenue North • Minneapolis, Minnesota 55441
763-544-3164 • 1-888-373-6767

www.bannerengineering.com

217889 Rev A