

Operating Instructions

Picomag IO-Link

Electromagnetic flowmeter

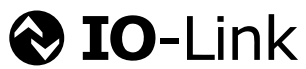

- Make sure the document is stored in a safe place such that it is always available when working on or with the device.
- To avoid danger to individuals or the facility, read the "Basic safety instructions" section carefully, as well as all other safety instructions in the document that are specific to working procedures.
- The manufacturer reserves the right to modify technical data without prior notice. Your Endress+Hauser Sales Center will supply you with current information and updates to these instructions.

Table of contents

1	About this document	5	7	Operation options	20
1.1	Document function	5	7.1	Access to the operating menu via the SmartBlue app	20
1.2	Symbols used	5	8	System integration	21
1.2.1	Safety symbols	5	8.1	Overview of device description files	21
1.2.2	Electrical symbols	5	8.2	Device master file	21
1.2.3	Communication-specific symbols	5	9	Commissioning	22
1.2.4	Symbols for certain types of information	6	9.1	Switching ON the measuring device	22
1.2.5	Symbols in graphics	6	9.2	Overview of the operating menu	22
1.3	Documentation	6	9.3	Configuring the measuring device	22
1.4	Registered trademarks	6	9.3.1	Identification	22
2	Basic safety instructions	8	9.3.2	Configuring system units	22
2.1	Requirements for the personnel	8	9.3.3	Setting the installation direction and measurement	23
2.2	Intended use	8	9.3.4	Configuring the IO modules	24
2.3	Workplace safety	8	9.3.5	Totalizer	29
2.4	Operational safety	9	9.3.6	Configuring the display	30
2.5	Product safety	9	9.3.7	Data management	31
2.6	IT security	9	9.3.8	Security	31
2.7	Device-specific IT security	9	9.4	Diagnostics	32
2.7.1	Access via the SmartBlue app	9	9.5	System	32
2.7.2	Protecting access via a password	9	10	Operation	33
2.7.3	Access via Bluetooth® wireless technology	10	10.1	Offline quick view of configuration	33
3	Incoming acceptance and product identification	11	11	Diagnostics and troubleshooting ...	35
3.1	Incoming acceptance	11	11.1	General troubleshooting	35
3.2	Product identification	11	11.2	Diagnostic information on local display	36
3.2.1	Symbols on measuring device	12	11.2.1	Diagnostic message	36
4	Storage and transport	13	11.3	Overview of diagnostic events	37
4.1	Storage conditions	13	11.4	Device information	37
4.2	Transporting the product	13	11.5	Firmware history	38
4.3	Packaging disposal	13	12	Accessories	39
5	Mounting	14	13	Technical data	41
5.1	Mounting requirements	14	13.1	Input	41
5.1.1	Mounting position	14	13.2	Output	41
5.2	Mounting the measuring device	14	13.3	Power supply	41
6	Electrical connection	16	13.4	Performance characteristics	41
6.1	Electrical safety	16	13.5	Installation	42
6.2	Connecting requirements	16	13.6	Environment	42
6.2.1	Requirements for connecting cable ...	16	13.7	Process	42
6.2.2	Pin assignment, device plug	16	13.8	Mechanical construction	43
6.3	Connecting the measuring device	19	13.9	Operability	45
6.4	Post-connection check	19	13.10	Certificates and approvals	46

14	Appendix	47
14.1	Radio approvals	47
14.1.1	Argentina	47
14.1.2	Brazil	47
14.1.3	Europe	47
14.1.4	India	47
14.1.5	Indonesia	48
14.1.6	Canada and United States	48
14.1.7	Mexico	48
14.1.8	Republic of Korea	49
14.1.9	Singapore	49
14.1.10	Taiwan	49
14.1.11	Thailand	49
14.1.12	United Arab Emirates	50
14.1.13	Other countries	50
14.2	IO-Link process data	51
14.2.1	Data structure	51
14.2.2	Diagnostic information	51
14.3	IO-Link ISDU parameter list	52
	Index	59

1 About this document

1.1 Document function

These Operating Instructions contain all the information that is required in various phases of the life cycle of the device: from product identification, incoming acceptance and storage, to mounting, connection, operation and commissioning through to troubleshooting, maintenance and disposal.

1.2 Symbols used

1.2.1 Safety symbols

DANGER

This symbol alerts you to a dangerous situation. Failure to avoid this situation will result in serious or fatal injury.

WARNING

This symbol alerts you to a dangerous situation. Failure to avoid this situation can result in serious or fatal injury.



CAUTION

This symbol alerts you to a dangerous situation. Failure to avoid this situation can result in minor or medium injury.



NOTICE

This symbol contains information on procedures and other facts which do not result in personal injury.











1.2.2 Electrical symbols

Symbol	Meaning
	Direct current
	Ground connection A grounded terminal which, as far as the operator is concerned, is grounded via a grounding system.

1.2.3 Communication-specific symbols

Symbol	Meaning
	Bluetooth® Wireless data transmission between devices over a short distance.
 IO-Link®	IO-Link Communications system for connecting intelligent sensors and actuators to an automation system. In the IEC 61131-9 standard, IO-Link is standardized under the name "Single-drop digital communication interface for small sensors and actuators (SDCI)".

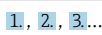
1.2.4 Symbols for certain types of information

Symbol	Meaning
	Permitted Procedures, processes or actions that are permitted.
	Preferred Procedures, processes or actions that are preferred.
	Forbidden Procedures, processes or actions that are forbidden.
	Tip Indicates additional information.
	Reference to documentation
	Reference to page
	Reference to graphic
	Notice or individual step to be observed
	Series of steps
	Result of a step

1.2.5 Symbols in graphics

Symbol	Meaning
1, 2, 3, ...	Item numbers
A, B, C, ...	Views

1.3 Documentation

 For an overview of the scope of the associated Technical Documentation, refer to the following:

- The *W@M Device Viewer*: Enter the serial number of the measuring device (www.endress.com/deviceviewer)
- The *Endress+Hauser Operations App*: Enter the serial number of the measuring device or scan the 2-D matrix code on the measuring device.

1.4 Registered trademarks

IO-Link®

Is a registered trademark. It may only be used in conjunction with products and services by members of the IO-Link Community or by non-members who hold an appropriate license. For more specific guidelines on use, refer to the IO-Link Community rules on:

www.io.link.com.

Bluetooth® wireless technology



The Bluetooth® word mark and logos are registered trademarks owned by the Bluetooth SIG, Inc. and any use of such marks by Endress+Hauser is under license.

Apple®

Apple, the Apple logo, iPhone, and iPod touch are trademarks of Apple Inc., registered in the U.S. and other countries. App Store is a service mark of Apple Inc.

Android®

Android, Google Play and the Google Play logo are trademarks of Google Inc.

2 Basic safety instructions

2.1 Requirements for the personnel

The personnel for installation, commissioning, diagnostics and maintenance must fulfill the following requirements:

- ▶ Trained, qualified specialists must have a relevant qualification for this specific function and task.
- ▶ Are authorized by the plant owner/operator.
- ▶ Are familiar with federal/national regulations.
- ▶ Before starting work, read and understand the instructions in the manual and supplementary documentation as well as the certificates (depending on the application).
- ▶ Follow instructions and comply with basic conditions.

The operating personnel must fulfill the following requirements:

- ▶ Are instructed and authorized according to the requirements of the task by the facility's owner-operator.
- ▶ Follow the instructions in this manual.

2.2 Intended use

Application and media

The measuring device described in this manual is intended only for the flow measurement of liquids with a minimum conductivity of 10 $\mu\text{S}/\text{cm}$.

To ensure that the measuring device remains in proper condition for the operation time:

- ▶ Use the measuring device only for media to which the process-wetted materials have an adequate level of resistance.

Incorrect use

Non-designated use can compromise safety. The manufacturer is not liable for damage caused by improper or non-designated use.

WARNING

Danger of breakage due to corrosive or abrasive fluids and ambient conditions!

- ▶ Verify the compatibility of the process fluid with the sensor material.
- ▶ Ensure the resistance of all fluid-wetted materials in the process.
- ▶ Keep within the specified pressure and temperature range.

Residual risks

WARNING

If the temperature of the media or electronics unit is high or low, this may cause the surfaces of the device to become hot or cold. This poses a risk of burns or frostbite!

- ▶ In the case of hot or cold medium temperatures, install appropriate protection against contact.

2.3 Workplace safety

For work on and with the device:

- ▶ Wear the required personal protective equipment according to national regulations.

For welding work on the piping:

- ▶ Do not ground the welding unit via the measuring device.

2.4 Operational safety

Risk of injury!

- ▶ Operate the device in proper technical condition and fail-safe condition only.
- ▶ The operator is responsible for interference-free operation of the device.

2.5 Product safety

This measuring device is designed in accordance with good engineering practice to meet state-of-the-art safety requirements, has been tested, and left the factory in a condition in which it is safe to operate.

It meets general safety standards and legal requirements. It also complies with the EU directives listed in the device-specific EU Declaration of Conformity. Endress+Hauser confirms this by affixing the CE mark to the device.

Furthermore, the device meets the legal requirements of the applicable UK regulations (Statutory Instruments). These are listed in the UKCA Declaration of Conformity along with the designated standards.

By selecting the order option for UKCA marking, Endress+Hauser confirms a successful evaluation and testing of the device by affixing the UKCA mark.

Contact address Endress+Hauser UK:

Endress+Hauser Ltd.
Floats Road
Manchester M23 9NF
United Kingdom
www.uk.endress.com

2.6 IT security

Our warranty is valid only if the device is installed and used as described in the Operating Instructions. The device is equipped with security mechanisms to protect it against any inadvertent changes to the settings.

IT security measures, which provide additional protection for the device and associated data transfer, must be implemented by the operators themselves in line with their security standards.

2.7 Device-specific IT security

2.7.1 Access via the SmartBlue app

Two access levels (user roles) are defined for the device: the **Operator** user role and the **Maintenance** user role. The **Maintenance** user role is the default setting.

If a user-specific access code is not defined (in the **Set access code** parameter), the default setting **0000** continues to apply and the **Maintenance** user role is automatically enabled. The device's configuration data are not write-protected and can be edited at all times.

If a user-specific access code has been defined (in the **Set access code** parameter), all the parameters are write-protected and the device is accessed with the **Operator** user role. The previously defined access code must first be entered again before the **Maintenance** user role is enabled and all the parameters can be write-accessed.

2.7.2 Protecting access via a password

Different passwords are available to protect write access to the device parameters or access to the device via the Bluetooth® interface.

- User-specific access code
 - Protect write access to the device parameters via the SmartBlue app
- Bluetooth key
 - The password protects a connection between an operating device (e.g. smartphone, tablet) and the device via the Bluetooth® interface.

General notes on the use of passwords

- The access code and Bluetooth key supplied with the device should be changed during commissioning.
- Follow the general rules for generating a secure password when defining and managing the access code or Bluetooth key.
- The user is responsible for the management and careful handling of the access code and Bluetooth key.

2.7.3 Access via Bluetooth® wireless technology

Secure signal transmission via Bluetooth® wireless technology uses an encryption method tested by the Fraunhofer Institute.

- The device is not visible via *Bluetooth*® wireless technology without the SmartBlue App.
- Only one point-to-point connection is established between the device and a smartphone or tablet.
- The *Bluetooth*® wireless technology interface can be disabled via SmartBlue.

3 Incoming acceptance and product identification

3.1 Incoming acceptance

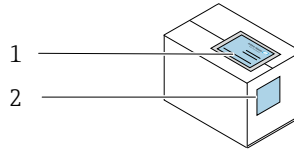

Are the order codes on the delivery note (1) and the product sticker (2) identical?

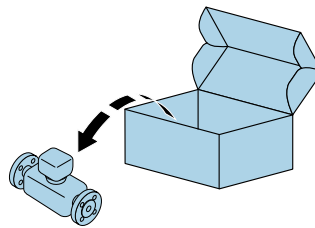

Are the goods undamaged?

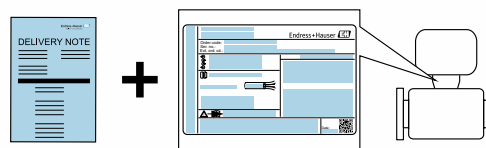

Do the data on the nameplate match the ordering information on the delivery note?

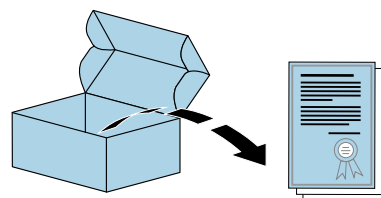

Is the accompanying safety data sheet present?





- If one of the conditions is not satisfied, contact your Endress+Hauser Sales Center.
- The Technical Documentation is available via the Internet or via the *Endress+Hauser Operations App*, see the "Product identification" section .

3.2 Product identification

The following options are available for identification of the measuring device:

- The device label
- Order code with breakdown of the device features on the delivery note
- Enter the serial number on the device label in *W@M Device Viewer* (www.endress.com/deviceviewer): all the information about the measuring device is displayed.
- Enter the serial number on the device label into the *Endress+Hauser Operations App* or scan the 2-D matrix code (QR code) on the measuring device with the *Endress+Hauser Operations App*: all the information about the measuring device is displayed.

3.2.1 Symbols on measuring device

Symbol	Meaning
	WARNING! This symbol alerts you to a dangerous situation. Failure to avoid this situation can result in serious or fatal injury. To determine the nature of the potential hazard and the measures required to avoid it, consult the documentation accompanying the measuring device.
	Reference to documentation Refers to the corresponding device documentation.

4 Storage and transport

4.1 Storage conditions

Observe the following notes for storage:

- ▶ Store in the original packaging to ensure protection from shock.
- ▶ Store in a dry place.
- ▶ Do not store outdoors.

Storage temperature →  42

4.2 Transporting the product

Transport the device to the measuring point in the original packaging.

-  Do not remove protective covers or caps installed on process connections. They prevent mechanical damage to the sealing surfaces and contamination in the measuring tube.

4.3 Packaging disposal

All packaging materials are environmentally friendly and 100% recyclable: Carton in accordance with European Packaging Directive 94/62EC; recyclability is confirmed by the affixed RESY symbol.

5 Mounting

5.1 Mounting requirements

5.1.1 Mounting position

Mounting location

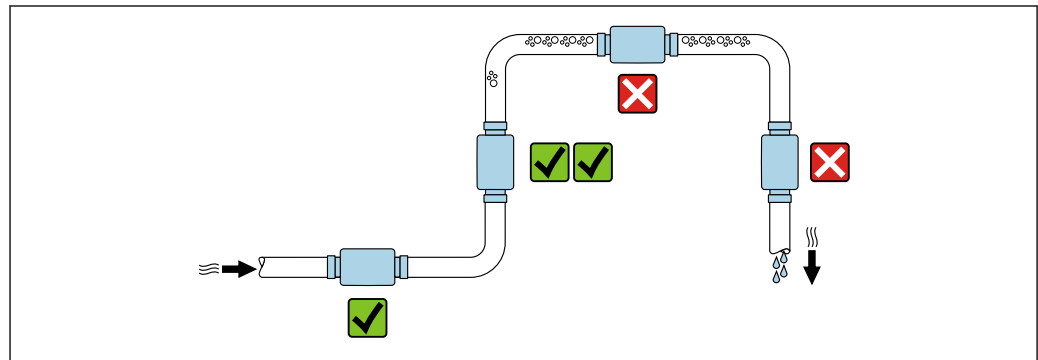

A0046065

Preferably install the sensor in an ascending pipe.

Inlet and outlet runs

No inlet and outlet runs need to be considered.

i The installation dimensions provide information on the dimensions and installed lengths of the device → 43

i The arrow points in the preferred direction of flow. Measurement in the other direction is also possible. → 23

5.2 Mounting the measuring device

i Install the measuring device without any mechanical tension so that pipe forces are not transferred to the measuring device.

WARNING

Burn hazard!

If medium temperatures or ambient temperatures exceed 50 °C, areas of the housing can heat to over 65 °C.

- ▶ Safeguard the housing so that it cannot be touched accidentally.

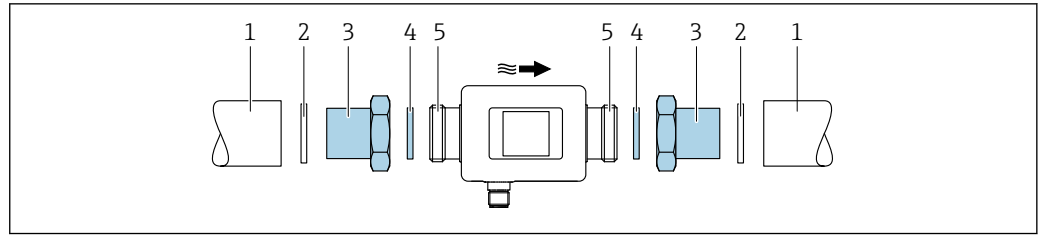

A0039002

1 Measuring device with male thread

- 1 Pipe with female thread
- 2 Seal (not supplied)
- 3 Adapter: available adapters → [39](#)
- 4 Seal (included in delivery)
- 5 Measuring device connection, male thread

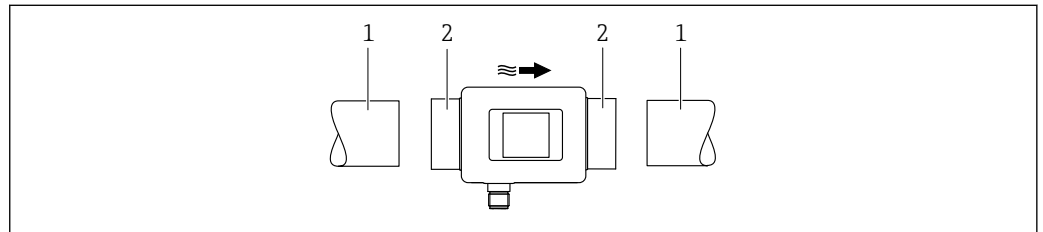

A0046929

2 Measuring device with female thread

- 1 Pipe with conical male thread
- 2 Measuring device connection, female thread

i No seals are included in the delivery for devices with a female thread. Suitable commercially available seal material can be used.

6 Electrical connection

6.1 Electrical safety

In accordance with applicable national regulations.

6.2 Connecting requirements

6.2.1 Requirements for connecting cable

National regulations and standards apply.

Connecting cable	M12 × 1 A-coded
Conductor cross-section	At least 0.12 mm ² (AWG26)
Degree of protection	IP65/67, pollution degree 3

6.2.2 Pin assignment, device plug

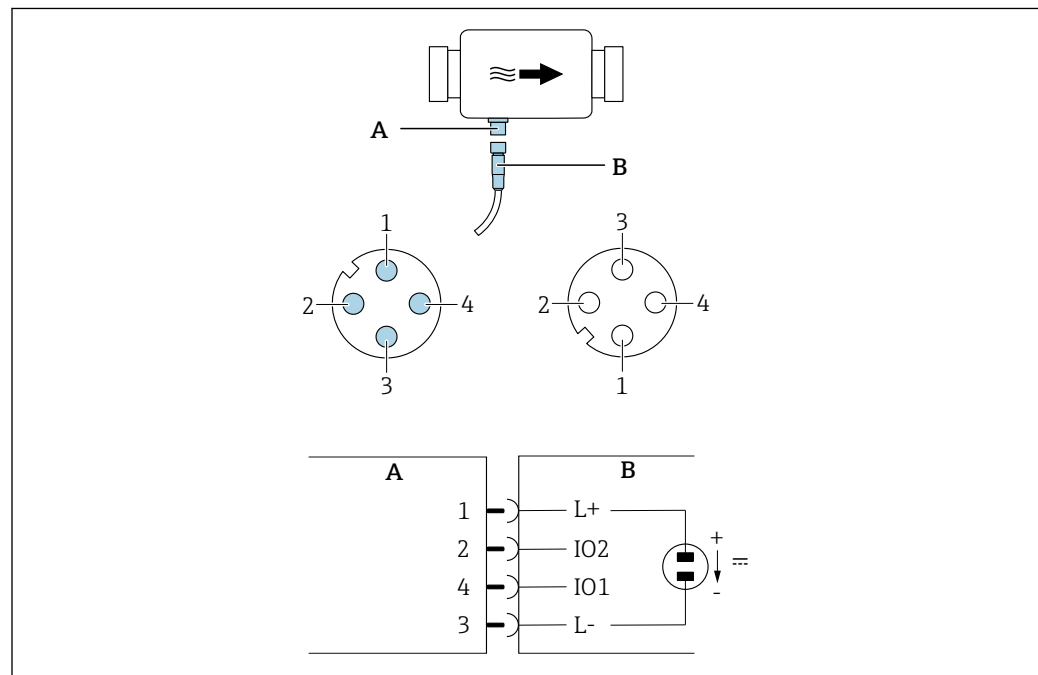

A0039004

A Plug (measuring device)

B Socket (customer side)

1...4 Pin assignment

Pin assignment

Pin	Assignment	Description
1	L+	Supply voltage + (18 to 30 V _{DC} /max. 3 W)
2	IO2	Input/output 2, can be configured independently of IO1
3	L-	Supply voltage -
4	IO1	Input/output 1, can be configured independently of IO2

Switch output configuration version

The switching behavior of IO1 and IO2 can be configured independently of one another.

PNP ¹⁾	NPN ²⁾
<p>A Plug (measuring device) B Socket (customer side) L+ Supply voltage + L- Supply voltage -</p>	<p>A Plug (measuring device) B Socket (customer side) L+ Supply voltage + L- Supply voltage -</p>
<p>The load is switched to high side L+. The maximum load current is 250 mA. The output is protected against short-circuiting and reverse polarity.</p>	<p>The load is switched to low side L-. The maximum load current is 250 mA. The output is protected against short-circuiting and reverse polarity.</p>

- 1) Positive Negative Positive (high side switch)
- 2) Negative Positive Negative (low side switch)

Pulse output configuration version

Option only available for output 1 → 25

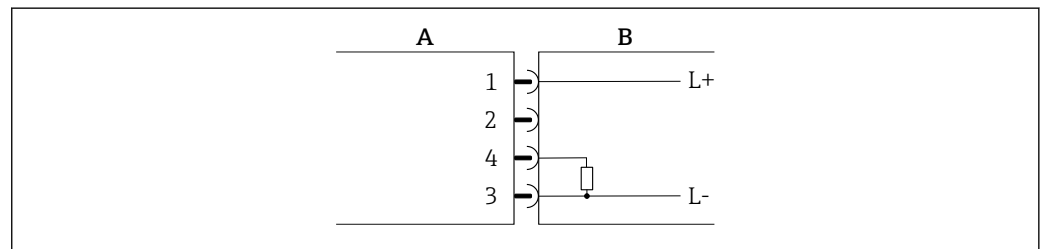

3 Pulse output with PNP switching behavior

- A Plug (measuring device)
- B Socket (customer side)
- L+ Supply voltage +
- L- Supply voltage -

The load is switched to high side L+. The maximum load current is 250 mA. The output is protected against short-circuiting and reverse polarity.

Current output configuration version

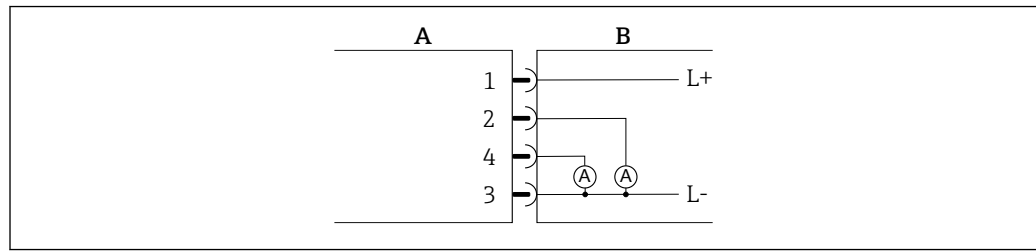

A0046581

4 Current output, active, 4 to 20 mA

A Plug (measuring device)

B Socket (customer side)

L+ Supply voltage +

L- Supply voltage -

The current flows from the output to L-. The maximum load may not exceed 500 Ω . A bigger load distorts the output signal.

Voltage output configuration version

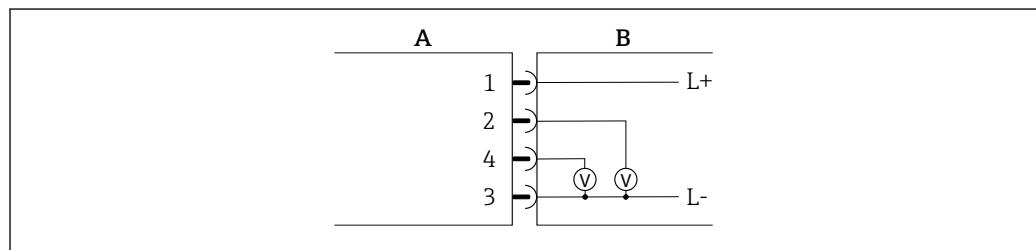

A0046582

5 Voltage output, active, 2 to 10 V

A Plug (measuring device)

B Socket (customer side)

L+ Supply voltage +

L- Supply voltage -

The voltage from the output applies to L-. The load must be at least 600 Ω . The output is protected against short-circuiting and reverse polarity.

Digital input configuration version

- 15 V (switch-on threshold)
- 5 V (switch-off threshold)

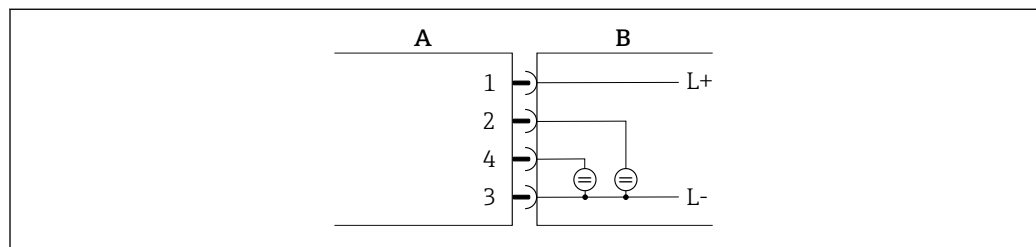

A0033008

6 Digital input

A Plug (measuring device)

B Socket (customer side)

L+ Supply voltage +

L- Supply voltage -

Internal resistance: 7.5 kΩ

IO-Link configuration version

i Option only available for output 1 in the **Output 1** → 24 submenu

The measuring device features an IO-Link communication interface with a baud rate of 38,400 and with a second IO function on pin 2. This requires an IO-Link compatible module (IO-Link master) for operation. The IO-Link communication interface allows direct access to the process and diagnostics data.

6.3 Connecting the measuring device

NOTICE

The measuring device may only be installed by properly trained technicians.

- ▶ Comply with national and international regulations regarding the installation of electrotechnical systems.
- ▶ Power supply according to EN 50178, SELV, PELV or Class 2.

1. De-energize the system.
2. Connect the measuring device via the connector.
- 3.

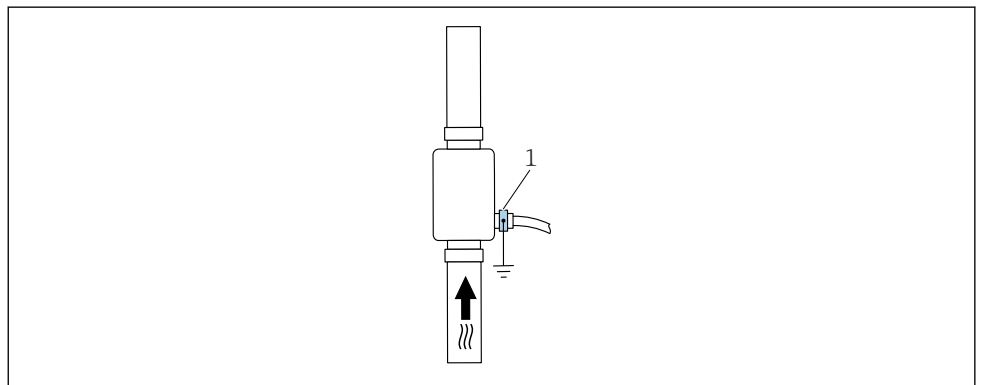

A0046190

1 Ground terminal

In the case of non-grounded pipes:
The device must be grounded using the ground terminal accessory.

6.4 Post-connection check

Are cables or the device undamaged (visual inspection)?	<input type="checkbox"/>
Do the cables have adequate strain relief?	<input type="checkbox"/>
Is the connector connected correctly?	<input type="checkbox"/>
Does the supply voltage match the specifications on the measuring device?	<input type="checkbox"/>
Is the pin assignment of the connector correct?	<input type="checkbox"/>
Is the potential equalization established correctly?	<input type="checkbox"/>

7 Operation options

7.1 Access to the operating menu via the SmartBlue app

The device can be operated and configured via the SmartBlue app. In this case, the connection is established via the Bluetooth® wireless technology interface.

Supported functions

- Device selection in Live List and access to the device (login)
- Configuration of the device
- Access to measured values, device status and diagnostic information

The SmartBlue app is available to download free of charge for Android devices (Google Playstore) and iOS devices (iTunes Apple Store): *Endress+Hauser SmartBlue*

Directly to the app with the QR code:



A0039202

System requirements

- Devices with iOS:
From iOS 11
- Devices with Android:
Android 6.0 KitKat or higher

Downloading the SmartBlue app:

1. Install and start the SmartBlue app.
 - ↳ A Live List shows all the devices available.
The list displays the devices with the configured tag name. The default setting for the tag name is **EH_DMA_XYZZ** (XYZZ = the last 7 digits of the device serial number).
2. For Android devices, activate GPS positioning (not necessary for devices with IOS)
3. Select the device from the Live List.
 - ↳ The Login dialog box opens.

Logging in:

4. Enter the user name: **admin**
5. Enter the initial password: serial number of the device.
 - ↳ When you log in for the first time, a message is displayed advising you to change the password.
6. Confirm your entry.
 - ↳ The main menu opens.
7. Optional: Change Bluetooth® password: Menu: Guidance → Security → Change Bluetooth password

 Forgotten your password: contact Endress+Hauser Service.

 Navigate through the various items of information about the device: swipe the screen to the side.

8 System integration

The measuring device has an IO-Link communication interface. The IO-Link interface allows direct access to process and diagnostics data and enables the user to configure the measuring device on the fly.

Properties:

- IO-Link Specification: Version 1.1
- IO-Link Smart Sensor Profile 2nd Edition
- SIO mode: yes
- Speed: COM2 (38.4 kBaud)
- Minimum cycle time: 10 ms
- Process data width: 120 bit
- IO-Link data storage: yes
- Block configuration: no
- Device operational: The measuring device is operational 4 seconds after the supply voltage is applied

 More information on IO-Link is available at www.io-link.com

 Overview of the entire IO-Link ISDU parameter list →  52

8.1 Overview of device description files

Current version data for the device

Firmware version	01.01.zz	Information on the firmware version can be found: <ul style="list-style-type: none"> ▪ On the title page of the Operating instructions ▪ On the device label ▪ In the Firmware version parameter in the System menu
Release date of firmware version	05.2019	---
Profile version	<ul style="list-style-type: none"> ▪ 1.1 ▪ Smart Sensor Profile 	---

8.2 Device master file

In order to integrate field devices into a digital communication system, the IO-Link system needs a description of the device parameters, such as output data, input data, data format, data volume and supported transfer rate.

These data are available in the device master file (IODD¹⁾), provided to the IO-Link master when the communication system is commissioned.

-  The IODD can be downloaded as follows:
- Endress+Hauser: www.endress.com
 - IODDfinder: <http://ioddfinder.io-link.com>

1) IO Device Description

9 Commissioning

9.1 Switching ON the measuring device

Once the supply voltage has been switched on, the measuring device adopts the normal mode after a maximum of 4 s. During the start-up phase, the outputs are in the same state as the measuring device in the switched-off state.

9.2 Overview of the operating menu

Overview of the operating menu

Guidance	
	<ul style="list-style-type: none"> ▶ Identification → 22 ▶ System units → 22 ▶ Sensor → 23 ▶ Output 1 → 24 ▶ Output 2 → 24 ▶ Totalizer → 29 ▶ Display → 30 ▶ Data management → 31 ▶ Security → 31
Diagnostics	→ 32
System	
	<ul style="list-style-type: none"> ▶ Data management → 32 ▶ Firmware → 32

9.3 Configuring the measuring device

9.3.1 Identification

The device tag and the user level can be changed in the **Identification** submenu.

Navigation

Menu: "Guidance" → Identification

9.3.2 Configuring system units

In the **System units** submenu, you can configure the units of all measured values.

Navigation

Menu: "Guidance" → System units

Parameter overview with brief description

Parameter	Description	Selection	Factory setting
Volume flow unit	Select the unit for the volume flow.	<ul style="list-style-type: none"> ▪ l/s, m³/h, l/min, l/h ▪ gal/min (us), fl. oz/min 	l/min
Volume unit	Select the unit for the volume.	<ul style="list-style-type: none"> ▪ ml, l, m³ ▪ fl. oz (us), gal (us) 	ml
Temperature unit	Select the unit for the temperature.	<ul style="list-style-type: none"> ▪ °C ▪ °F 	°C
Totalizer unit	Select the unit for the totalizer.	<ul style="list-style-type: none"> ▪ ml, l, m³ ▪ kl, Ml ▪ fl. oz (us), gal (us) ▪ kgal (us) 	m ³
Conductivity unit	Select the unit for conductivity.	<ul style="list-style-type: none"> ▪ µS/cm ▪ S/m ▪ mS/cm 	µS/cm

9.3.3 Setting the installation direction and measurement

The **Sensor** submenu contains parameters for specific settings of the measuring device.

Navigation





Menu: "Guidance" → Sensor

Parameter overview with brief description

Parameter	Description	Selection/input	Factory setting
Installation direction	Select the installation direction.	<ul style="list-style-type: none"> ▪ Flow in arrow direction (forwards) Positive flow measurement in the direction of the arrow. ▪ Flow against arrow direction (backwards) Positive flow measurement in the opposite direction of the arrow. 	Flow in arrow direction (forwards)
On value	Enter the on value for low flow cut off.	<p>Positive floating point number</p> <p> A flow measured value that is less than the value of the on value forces the display to zero. In the event of plant downtime, this prevents the totalizer from continuing to totalize even though there is no flow. The measured value flashes on the display when low flow cut off is active. Low flow cut off is deactivated again as soon as the flow measured value exceeds 1.5 times the on value.</p>	<p>Depends on the nominal diameter:</p> <p>DN 15 (½"): 0.05 l/min (0.013 gal/min)</p> <p>DN 20 (¾"): 0.1 l/min (0.026 gal/min)</p> <p>DN 25 (1"): 0.2 l/min (0.052 gal/min)</p> <p>DN 50 (2"): 1.5 l/min (0.4 gal/min)</p>
Damping	Enter the time constant for damping the flow measured value.	0 to 10 s	0 s

9.3.4 Configuring the IO modules

The measuring device has two signal inputs or signal outputs that can be configured independently of one another:

- Current output →  24
- Pulse output →  25
- Switch output →  26
- Voltage output →  27
- Digital input →  28

Navigation

Menu: "Guidance" → Output 1

Menu: "Guidance" → Output 2

Parameter overview with brief description

Parameter	Description	Selection	Factory setting
Output 1	Select the operating mode of output 1.	<ul style="list-style-type: none"> ■ Pulse output ■ Current output ■ Switch output ■ Voltage output ■ Digital input ■ IO-Link ■ Off 	IO-Link
Output 2	Select the operating mode of output 2.	<ul style="list-style-type: none"> ■ Current output ■ Switch output ■ Voltage output ■ Digital input ■ Off 	Off

Configuring the current output

The Current output submenu contains all the parameters that must be configured for the configuration of the current output.

The output is used to output process variables by analog means in the form of a 4-20 mA current.

Navigation

Menu: "Guidance" → Output 1 → Current output

Menu: "Guidance" → Output 2 → Current output

Parameter overview with brief description

Parameter	Description	Selection/input	Factory setting
Assign current output	Select process variable for current output.	<ul style="list-style-type: none"> ■ Off ■ Volume flow ■ Temperature ■ Conductivity 	Volume flow
4 mA value	Enter 4 mA value.	Floating point number with sign	0 l/min
20 mA value	Enter 20 mA value.	Floating point number with sign	Depends on the nominal diameter: DN 15 (½"): 25 l/min (6.6 gal/min) DN 20 (¾"): 50 l/min (13.2 gal/min) DN 25 (1"): 100 l/min (26.4 gal/min) DN 50 (2"): 750 l/min (198.1 gal/min)

Unidirectional flow measurement (Q), conductivity measurement (S)

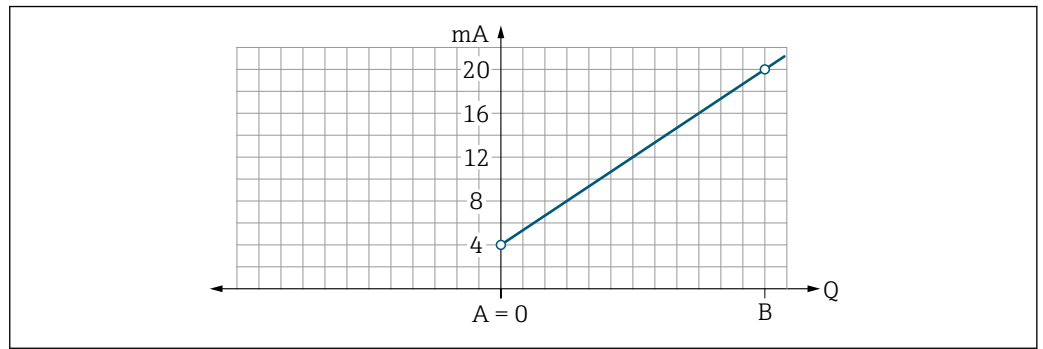

A Lower range value = 0
 B Upper range value
 Q Flow

- Current I is linearly interpolated between lower range value (A) and upper range value (B).
- The output range ends at 20.5 mA.

Bidirectional flow measurement (Q), temperature measurement (T)

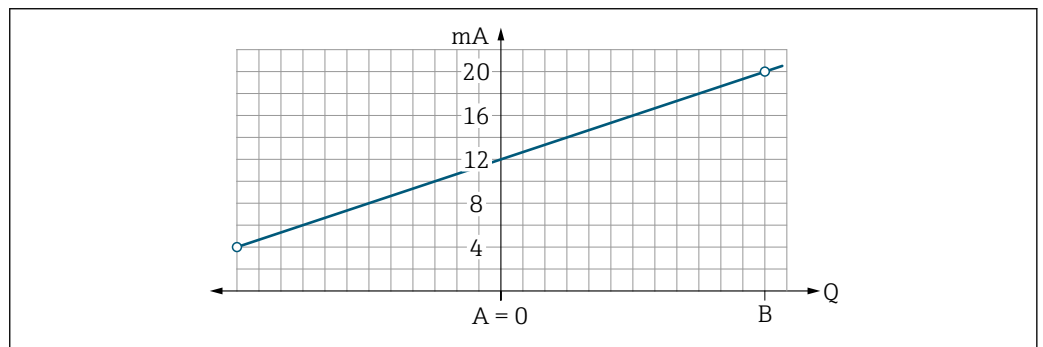

A Lower range value
 B Upper range value
 Q Flow

- Current I is linearly interpolated between lower range value (A) and upper range value (B).
- Rather than having a hard upper and lower limit, the output range ends at 20.5 mA at the top end and at 3.8 mA at the bottom end

Configuring the pulse output

The Pulse output submenu contains all the parameters that must be configured for the configuration of the pulse output.

Navigation

Menu: "Guidance" → Output 1

Parameter overview with brief description

Parameter	Description	User entry	Factory setting
Value per pulse	Enter the value for the pulse output.	Floating point number with sign	Depends on the nominal diameter: DN 15 (1/2"): 0.5 ml DN 20 (3/4"): 1.0 ml DN 25 (1"): 2.0 ml DN 50 (2"): 10.0 ml

The current pulse repetition frequency is calculated from the current flow and the configured pulse value:

Pulse repetition frequency = flow/pulse value

Example

- Flow: 24 l/min
- Pulse value: 0.001 l
- Pulse repetition frequency = 400 Pulse/s

The pulse output only outputs positive flow components in the set installation direction. Negative flow components are ignored and not balanced.

 Low flow cut off →  23 resets the pulse output.

Configuring the switch output

The Switch output submenu contains all the parameters that must be configured for the configuration of the switch output.

Navigation

Menu: "Guidance" → Output 1

Menu: "Guidance" → Output 2

Parameter overview with brief description

Parameter	Description	Selection/input	Factory setting
Polarity	Select the switching behavior.	<ul style="list-style-type: none"> ■ NPN (low-side-switch) Switches load to low side to L- ■ PNP (high-side-switch) Switches load to high side to L+ 	PNP (high-side-switch)
Switch output function		<ul style="list-style-type: none"> ■ Off The switch output is permanently switched off (open, non-conductive). ■ On The switch output is permanently switched on (closed, conductive). ■ Diagnostic behavior The output switches off when an event with the status signal F occurs ■ Limit volume flow Indicates if a specified limit value has been reached for the process variable. ■ Limit temperature Indicates if a specified limit value has been reached for the process variable. ■ Limit conductivity Indicates if a specified limit value has been reached for the process variable. ■ Limit volume totalizer ■ Range volume flow ■ Range temperature ■ Range conductivity ■ Range volume totalizer ■ Empty pipe detection Output switches off if empty pipe detection is activated. 	Off
Switch-on value	Enter the measured value for the switch-on value.	Floating point number with sign	1 000 m ³ /h
Switch-off value	Enter the measured value for the switch-off value.	Floating point number with sign	1 000 m ³ /h

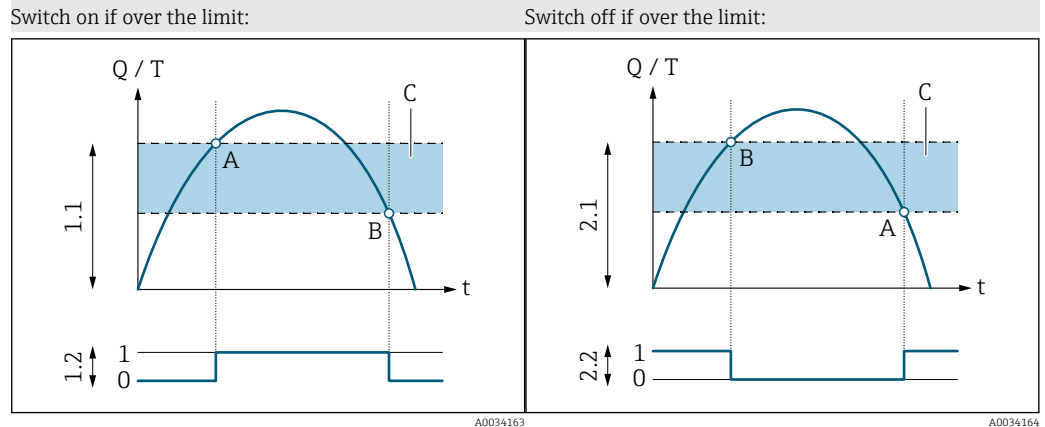

- 1.1 Input variables
- 1.2 Switch output
- A Switch-on point
- B Switch-off point
- C Hysteresis

- 2.1 Input variables
- 2.2 Switch output
- A Switch-on point
- B Switch-off point
- C Hysteresis

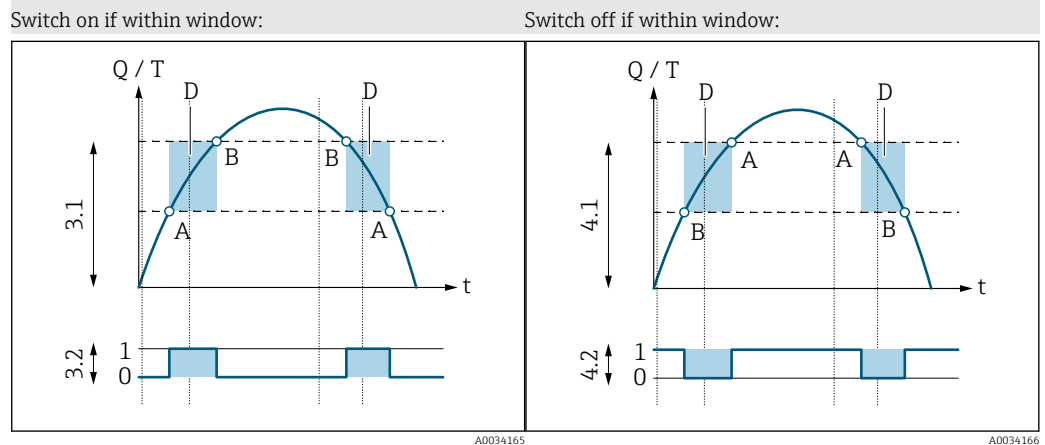

- 3.1 Input variables
- 3.2 Switch output
- A On-value (lower range limit)
- B Off-value (upper range limit)
- D Window

- 4.1 Input variables
- 4.2 Switch output
- A On-value (lower range limit)
- B Off-value (upper range limit)
- D Window

Configuring the voltage output

The Voltage output submenu contains all the parameters that must be configured for the configuration of the voltage output.

Navigation

Menu: "Guidance" → Output 1

Menu: "Guidance" → Output 2

Parameter overview with brief description

Parameter	Description	Selection/input	Factory setting
Assign voltage output	Select process variable for voltage output.	<ul style="list-style-type: none"> ■ Off ■ Volume flow ■ Temperature ■ Conductivity 	Volume flow
2 V value	Enter the lower range value.	Floating point number with sign	0 l/min
10 V value	Enter the upper range value.	Floating point number with sign	Depends on the nominal diameter: DN 15 (½"): 25 l/min DN 20 (¾"): 50 l/min DN 25 (1"): 100 l/min DN 50 (2"): 750 l/min

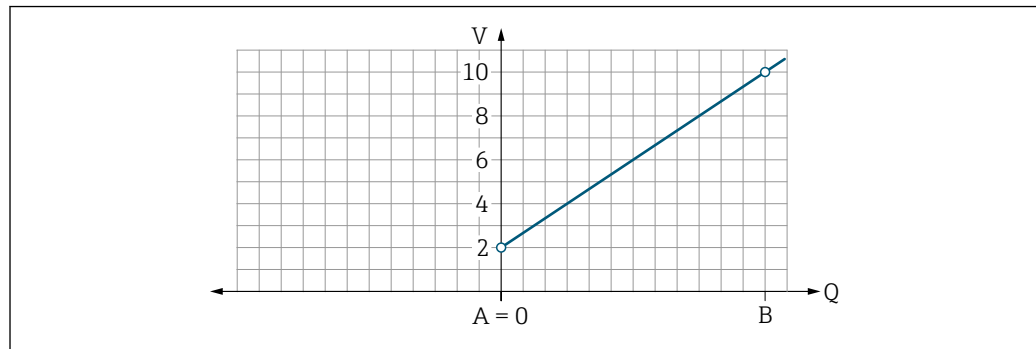
Unidirectional flow measurement (Q), conductivity measurement

A0032995

A Lower range value = 0
 B Upper range value
 Q Flow

- Voltage U is linearly interpolated between lower range value (A) and upper range value (B).
- The output range ends at 10.25 V.

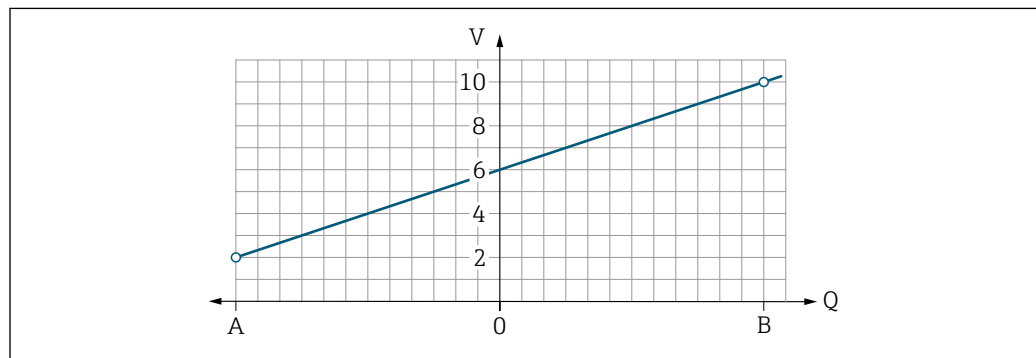
Bidirectional flow measurement (Q), temperature measurement (T)

A0032996

A Lower range value
 B Upper range value
 Q Flow

- Voltage U is linearly interpolated between lower range value (A) and upper range value (B).
- Rather than having a hard upper and lower limit, the output range ends at 10.25 V at the top end and at 1.9 V at the bottom end

Configuring the digital input

The **Digital input** submenu contains all the parameters that must be configured for the configuration of the digital input.

The input is used to control an action with an external voltage signal. The minimum pulse duration is 100 ms.

Navigation

Menu: "Guidance" → Output 1

Menu: "Guidance" → Output 2

Parameter overview with brief description

Parameter	Description	Selection	Factory setting
Active level	Select the switching behavior for the digital input.	<ul style="list-style-type: none"> ▪ High Input reacts to high level/positive edge ▪ Low Input reacts to low level/negative edge 	High
Assign status input	Select the function for the digital input.	<ul style="list-style-type: none"> ▪ Off ▪ Reset totalizer Reset the totalizer (edge controlled) (positive/negative edge) ▪ Flow override <ul style="list-style-type: none"> ▪ Flow measured value = 0 ▪ No effect on temperature measurement (level controlled) (high/low level) 	Reset totalizer

9.3.5 Totalizer

The totalizer can be reset with the **Reset totalizer** submenu.

Navigation

Menu: "Guidance" → Totalizer

Parameter overview with brief description

Parameter	Description	Display/options	Factory setting
Volume totalizer	Enter value.	Floating point number with sign	0 m ³
Reset totalizer	Reset the totalizer.	<ul style="list-style-type: none"> ▪ Cancel The totalizer is not reset. ▪ Reset + totalize The totalizer is reset. 	Cancel

9.3.6 Configuring the display

The **Display** submenu contains all the parameters that can be configured for the configuration of the onsite display.

Navigation

Menu: "Guidance" → Display

Parameter overview with brief description

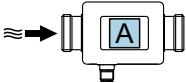
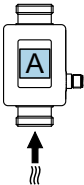
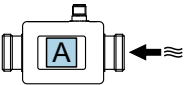
Parameter	Description	Selection/input	Factory setting
Format display	Select how measured values are shown on the display.	Display value 1st line + display value 2nd line: <ul style="list-style-type: none"> ▪ Volume flow + temperature ▪ Volume flow + totalizer ▪ Temperature + totalizer ▪ Volume flow + conductivity ▪ Totalizer + conductivity ▪ Temperature + conductivity 	Volume flow + temperature
		4 display values: Volume flow + temperature + totalizer + conductivity	
		2 display values (multiplex): Volume flow +totalizer / temperature + conductivity	
Rotation display	Select local display rotation.	<ul style="list-style-type: none"> ▪ Auto (automatic) ▪ The display rotates automatically depending on the installation position 	Auto
		<ul style="list-style-type: none"> ▪ 0° ▪ Can be read in the horizontal installation position with flow from left to right  <p style="text-align: right; font-size: small;">A0033013</p>	
		<ul style="list-style-type: none"> ▪ 90° ▪ Can be read in the vertical installation position with flow from bottom to top  <p style="text-align: right; font-size: small;">A0033014</p>	
		<ul style="list-style-type: none"> ▪ 180° ▪ Can be read in the horizontal installation position with flow from right to left  <p style="text-align: right; font-size: small;">A0033015</p>	

Parameter	Description	Selection/input	Factory setting
		<ul style="list-style-type: none"> ▪ 270° ▪ Can be read in the vertical installation position with flow from top to bottom 	
Backlight	Set the intensity of the backlighting.	0 to 100 %	50 %

9.3.7 Data management

Export configuration as report

The device configuration can be exported as a PDF report and saved in the mobile terminal or forwarded with this function.

Save configuration to file

The device configuration is saved in the app. The saved device configuration can be transferred to another measuring device using the System → "Load configuration from app" function.

Navigation

Menu: "Guidance" → Data management



9.3.8 Security

The **Security** submenu contains all the parameters needed to define the access code and configure the Bluetooth connection.

Navigation

Menu: "Guidance" → Security

Parameter overview with brief description

Parameter	Description	Entry/selection/display	Factory setting
Define access code	Define a user-specific access code to restrict write access to parameters.	4-digit string of numbers	0000
Bluetooth	Enable or disable the <i>Bluetooth</i> ® wireless technology interface.  If the interface is disabled, it can only be re-enabled by tapping the device.	<ul style="list-style-type: none"> ▪ Disable <ul style="list-style-type: none"> ▪ Disable the interface. ▪ The connection to the measuring device is torn down. ▪ Enable 	Enable
Change Bluetooth password	Change Bluetooth password  Keep the password safe. If it is lost, Endress+Hauser cannot restore access to the device.	Character string comprising numbers, letters and special characters	Device serial number

Enable Bluetooth by tapping the device

1. Activate Bluetooth by tapping on the housing three times.
2. Establish a connection to the device via the SmartBlue app.



9.4 Diagnostics

The **Diagnostics** menu enables you to simulate, without a real flow situation, various process variables in the process and the device alarm mode and to verify downstream signal chains (switching of valves or closed-control loops).

Navigation

"Diagnostics" menu

Parameter overview with brief description

Parameter	Description	Selection/input	Factory setting
Actual diagnostic	A diagnostic event has occurred.	Displays the current diagnostic event along with the diagnostic information.  If two or more messages occur simultaneously, the message with the highest priority is shown on the display.	Symbol for diagnostic behavior, diagnostic code and short message.
Simulation process variable	Activate the simulation of process variables.	<ul style="list-style-type: none"> ▪ Off Simulation is deactivated. ▪ On Simulation is activated.  Deactivate the simulation again once the test has been performed.	Off
Volume flow value	Enter the value for volume flow simulation.	Positive floating point number	-
Temperature value	Enter the value for temperature simulation.	Positive floating point number	-
Conductivity value	Enter the value for conductivity simulation	Positive floating point number	-

9.5 System

The **System** submenu contains all the parameters that can be used for the administration of the device.

Navigation

Menu: "System"

Parameter overview with brief description

Parameter	Description	Entry/selection/display	Factory setting
Access status tooling	Displays the access status. No user entry/selection possible.	<ul style="list-style-type: none"> ▪ Operator ▪ Maintenance 	Maintenance
Enter access code	Enter the defined access code. →  31 Restrict write access to parameters in order to protect the device configuration from unauthorized modification.	4-digit string of numbers	0000
Device reset	Reset the entire device configuration or some of the configuration to a defined state.	<ul style="list-style-type: none"> ▪ Cancel ▪ To factory defaults ▪ Restart device 	Cancel
Export configuration as report	The device configuration can be exported as a PDF report and saved in the mobile device or forwarded with this function.	-	-
Save configuration to file	The device configuration is saved in the app. The saved device configuration can be transferred to another measuring device using the System → "Load configuration from file" function.	-	-
Load Configuration from file	The saved device configuration can be uploaded to a new measuring device with this function.	-	-

10 Operation

10.1 Offline quick view of configuration

If you tap the top of the housing (e.g. on the arrow indicating the flow direction) with your fist or an object), the device displays an overview of the preset parameters.

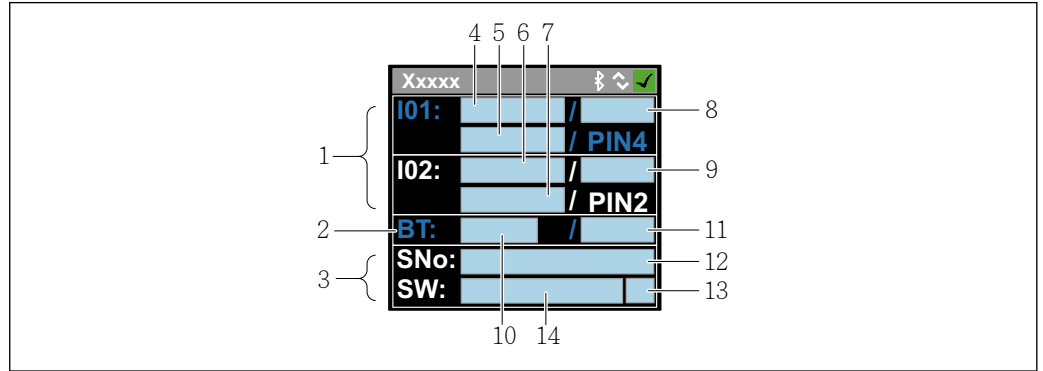



A0036432

7 Information in the status layout, overview of the preconfigured parameters

- 1 I/O area
- 2 Bluetooth area
- 3 Identification area
- 4 I/O type 1
- 5 I/O current value type 1
- 6 I/O type 2
- 7 I/O current value type 2
- 8 I/O assignment type 1
- 9 I/O assignment type 2
- 10 Bluetooth module status
- 11 Bluetooth connection status
- 12 Serial number
- 13 User role: Operator (O), Maintenance (M)
- 14 Software version

I/O area (in brackets: item number → 7, 33)

I/O type (4, 6)	I/O assignment (8, 9)	I/O current value (5, 7)
S-Out	<ul style="list-style-type: none"> ▪ Alrt ▪ LimQ ▪ LimT ▪ LimV ▪ Lims ▪ WinQ 	<ul style="list-style-type: none"> ▪ WinT ▪ WinV ▪ Wins ▪ EPD ▪ Off ▪ On
I-Out	<ul style="list-style-type: none"> ▪ s ▪ Q ▪ T 	Off
U-Out	<ul style="list-style-type: none"> ▪ s ▪ Q ▪ T 	Off
S-In	<ul style="list-style-type: none"> ▪ RsT ▪ OvrD 	Off
P-Out	Q	PNPOn PNPOff
IO-L	PD	<ul style="list-style-type: none"> ▪ Dis. ▪ Start
Off	-	<ul style="list-style-type: none"> ▪ PNPOn ▪ NPNOff ▪ Preop. ▪ Oper.

Bluetooth area (in brackets: item number →  7,  33)

Bluetooth module status (10)	Bluetooth connection status (11)
On	Dis./Con.
Off	Dis.

11 Diagnostics and troubleshooting

11.1 General troubleshooting

For local display

Error	Possible causes	Remedial action
Local display dark and no output signals	Supply voltage does not match the voltage specified on the nameplate.	Apply the correct supply voltage → 41.
	Supply voltage has incorrect polarity.	Correct the polarity.
	The connecting cables are not connected correctly.	Check the cable connection and correct if necessary.

For output signals

Error	Possible causes	Remedial action
Device shows correct value on local display, but signal output is incorrect, though in the valid range.	Parametrization errors	Check parameterization and correct it.
Device measures incorrectly.	Configuration error or device is operated outside the application.	1. Check and correct parameter configuration. 2. Observe limit values specified in the "Technical Data".



For access

Error	Possible causes	Remedial action
Measuring device not in smartphone or tablet live list	Bluetooth communication is disabled	1. Check whether the Bluetooth logo is visible on the local display or not. 2. Re-enable Bluetooth communication by tapping the device three times.
Device not responding via SmartBlue app	No Bluetooth connection	Enable Bluetooth function on smartphone or tablet.
	The device is already connected to another smartphone/tablet.	Check whether the device is already connected.
Login via SmartBlue app not possible	Device is being put into operation for the first time	Enter initial password (device serial number) and change.
Device cannot be operated via SmartBlue app	Incorrect password entered	Enter correct password.
	Password forgotten	Contact Endress+Hauser Service.
No write access to parameters	Current user role has limited access authorization	<ul style="list-style-type: none"> ▪ Check user role ▪ Enter the correct customer-specific access code → 20

11.2 Diagnostic information on local display

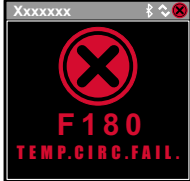

11.2.1 Diagnostic message

Faults detected by the self-monitoring system of the measuring device are displayed as a diagnostic message in alternation with the operational display.

Diagnostic message		
Alarm	Function check	Warning
 A0033011	 A0033010	 A0033009

If two or more diagnostic events are pending simultaneously, only the message of the diagnostic event with the highest priority is shown.

Diagnostic behavior



Diagnostic message	Meaning
	Alarm <ul style="list-style-type: none"> The measurement is interrupted. Signal outputs and totalizers assume the defined alarm condition. A diagnostic message is generated.
	Function check Process measured values are simulated to test the outputs/wiring. <ul style="list-style-type: none"> IO1/IO2 overload Flow override is active
	Warning <ul style="list-style-type: none"> Measurement is resumed. Measuring operation with limited accuracy The signal outputs and totalizers are not affected. A diagnostic message is generated.

Diagnostic behavior of outputs

Output	Diagnostic behavior
Switch output	<ul style="list-style-type: none"> The output is switched off (fail-safe) if events with the status signal F occur No further response to events with other status signals
Pulse output	<ul style="list-style-type: none"> Pulse output stops if events with the status signal F occur No further response to events with other status signals
Totalizer	<ul style="list-style-type: none"> Totalizer stops if events with the status signal F occur No further response to events with other status signals
Current output	<ul style="list-style-type: none"> 3.5 mA is output to signal events with the status signal F No further response to events with other status signals
Voltage output	<ul style="list-style-type: none"> 1.75 V is output to signal events with the status signal F No further response to events with other status signals
IO-Link	<ul style="list-style-type: none"> All events reported to the Master Events read and processed further by the Master

11.3 Overview of diagnostic events

Diagnostic event	Event text	Cause	Remedial measures	Status signal [ex-factory]
181	Coil. circ. fail.	Coil/frequency failure Coil current PWM outside tolerance range	Replace the measuring device.	F
180	Temp. circ. fail.	Temperature sensor open circuit/short-circuit	Replace the measuring device.	F
201	Device fail.	Internal hardware error	Replace the measuring device.	F
283	Memory fail.	CRC failure	Reset to factory settings.	F
446	I/O 1 overload	Overload at output 1	Increase load impedance.	C
447	I/O 2 overload	Overload at output 2	Increase load impedance.	C
485	Simulation act.	Measured value simulation active (via remote configuration)	–	C
453	Flow override	Flow override active (via auxiliary input)	–	C
441	I-Out 1 range	I-output 1 at range limit	Adjust parameter or process.	S
444	U-Out 1 range	U-output 1 at range limit	Adjust parameter or process.	S
443	P-Out 1 range	P-output 1 at range limit	Adjust parameter or process.	S
442	I-Out 2 range	I-output 2 at range limit	Adjust parameter or process.	S
445	U-Out 2 range	U-output 2 at range limit	Adjust parameter or process.	S
962	Empty pipe	Pipe is completely or partially empty	Adjust the process.	S
834	Temperat. range	Medium temperature outside the permitted range	Adjust the process.	S

 For more information on the diagnostics: see the "Diagnostics information" →  51

11.4 Device information

The **Device info** submenu contains all parameters that display different information for device identification.

Navigation

Menu: "System" → Device info

Parameter overview with brief description

Parameter	Description	User interface
Device name	Displays the name of the measuring device.	Picomag
Device tag	Shows name of measuring point.	Max. 32 characters, such as letters, numbers or special characters (e.g. @, %, /).
Serial number	Displays the serial number of the measuring device.	Max. 11-digit character string comprising letters and numbers.

Parameter	Description	User interface
Firmware version	Displays the device firmware version installed.	Character string in the format xx.yy.zz
Extended order code	Displays the extended order code.	Character string composed of letters, numbers and certain punctuation marks (e.g. /).

-  The following information is shown on the display by tapping once on the housing:
- Status and values for output 1
 - Status and values for output 2
 - Bluetooth status (On/Off)
 - Serial number
 - Software version

11.5 Firmware history

Release date	Firmware version	Firmware changes	Documentation type	Documentation
09.2017	01.00.zz	Original firmware	Operating Instructions	BA01697D/06/EN/01.17 BA01697D/06/EN/02.17 BA01697D/06/EN/03.17
05.2019	01.01.zz	<ul style="list-style-type: none"> ▪ Conductivity measurement ▪ Export configuration report ▪ Save/load configuration ▪ Bug fix 	Operating Instructions	BA01697D/06/EN/04.19 BA01697D/06/EN/05.20 BA01697D/06/EN/06.22

12 Accessories

Various accessories are available for the device, and can be ordered with the device or at a later stage from Endress+Hauser. An up-to-date overview of accessories is available from your local Endress+Hauser sales organization or on the product page of the Endress+Hauser website: www.endress.com.

Adapter set (suitable for devices with male thread)

Order number	Description
71355698	G $\frac{1}{2}$ " to G $\frac{3}{8}$ " male thread
71355699	G $\frac{1}{2}$ " to R $\frac{3}{8}$ " male thread
71355701	G $\frac{1}{2}$ " to G $\frac{1}{2}$ " female thread
71355702	G $\frac{1}{2}$ " to R $\frac{1}{2}$ " male thread
71355704	G $\frac{1}{2}$ " to $\frac{1}{2}$ " TriClamp
71355705	G $\frac{3}{4}$ " to R $\frac{3}{4}$ " male thread
71355707	G $\frac{3}{4}$ " to G $\frac{3}{4}$ " female thread
71355708	G $\frac{3}{4}$ " to R $\frac{3}{4}$ " TriClamp
71355709	G1" to R1" male thread
71355711	G1" to G1" female thread
71355712	G1" to 1" TriClamp
71355713	G2" to R1 $\frac{1}{2}$ " male thread
71355714	G2" to R2" male thread
71355717	G2" to G1 $\frac{1}{2}$ " male thread
71355718	G2" to G2" female thread
71355719	G2" to 2" TriClamp
71355720	G2" to 2" Victaulic
71399930	G2" to 54mm press fitting
71458012	Picomag adapter set G1/2"/R1/2" union nut
71458014	Picomag adapter set G3/4"/R1/2" union nut

Cable set

Order number	Description
71349260	2m/6.5ft, straight, 4x0.34, M12, PUR
71349261	5m/16.4ft, straight, 4x0.34, M12, PUR
71349262	10m/32.8ft, straight, 4x0.34, M12, PUR
71349263	2m/6.5ft, 90 degrees, 4x0.34, M12, PUR
71349264	5m/16.4ft, 90 degrees, 4x0.34, M12, PUR
71349265	10m/32.8ft, 90 degrees, 4x0.34, M12, PUR

Seal set (suitable for devices with male thread)

Order number	Description
71354741	DMA15 aramid fiber
71354742	DMA20 aramid fiber
71354745	DMA25 aramid fiber
71354746	DMA50 aramid fiber

Ground terminal set

Order number	Description
71345225	Ground terminal

13 Technical data

13.1 Input

Measured variables	<ul style="list-style-type: none"> ▪ Volume flow ▪ Temperature ▪ Conductivity
Measuring range	DN 15 (½"): 0.05 to 35 l/min (0.013 to 9.2 gal/min)
Volume flow measurement	DN 20 (¾"): 0.1 to 75 l/min (0.026 to 19.8 gal/min)
	DN 25 (1"): 0.2 to 150 l/min (0.052 to 39.6 gal/min)
	DN 50 (2"): 1.5 to 750 l/min (0.4 to 198.1 gal/min)
Measuring range	-10 to +70 °C (+14 to +158 °F)
Medium temperature measurement	
Measuring range	DN 15 (½"): 20 to 30 000 µS/cm
Conductivity measurement	DN 20 (¾"): 20 to 30 000 µS/cm
	DN 25 (1"): 20 to 30 000 µS/cm
	DN 50 (2"): 20 to 10 000 µS/cm
Digital input	<ul style="list-style-type: none"> ▪ High or low active ▪ Switch-on level 15 V ▪ Switch-off level 5 V ▪ Internal resistance 7.5 kOhm

13.2 Output

Output	Max. load
Current output	500 Ω Load must not be greater
Voltage output	600 Ω Load must not be smaller
Pulse output	Max. pulse rate: 10 000 Pulse/s
Signal on alarm	<ul style="list-style-type: none"> ▪ Status signal (as per NAMUR Recommendation NE 107) ▪ Plain text display with remedial action
Switch output	<ul style="list-style-type: none"> ▪ Switching behavior: PNP or NPN ▪ Max. load 250 mA

13.3 Power supply

Supply voltage range	18 to 30 V _{DC} (SELV, PELV, Class 2)
Power consumption	Maximum 3 W <ul style="list-style-type: none"> ▪ Without outputs IO1 and IO2: 120 mA ▪ With outputs IO1 and IO2: 120 mA plus the effective load currents

13.4 Performance characteristics

Volume flow measurement	
Reference operating conditions	Water, +15 to +45 °C, 2 to 6 bar
Maximum measured error	±0.8 % o.r. ±0.1 % o.f.s.
Repeatability	±0.2 % o.r.
Medium temperature measurement	
Maximum measured error	±2.5 °C
Repeatability	±0.5 °C
Conductivity measurement	
Repeatability	±5 %o.r. ±5 µS/cm

Maximum measured error, current output

Additional error	±20 µA ¹⁾
Repeatability	±10 µA
Response time T90	Typically 200 ms

1) At a device temperature of 25 °C.

Maximum measured error, voltage output

Additional error	±60 mV ¹⁾
Repeatability	±10 mV
Response time T90	Typically 200 ms

1) At a device temperature of 25 °C.

i The response time T90 is the time a measuring system needs to display 90% of the change of the measured value.

13.5 Installation

→ 14

13.6 Environment

Ambient temperature range	-10 to +60 °C (+14 to +140 °F)
Storage temperature	-25 to +85 °C (-13 to +185 °F)
Degree of protection	IP65/67, pollution degree 3
Humidity and moisture	Suitable for indoor environments with up to 100% rh (wet and damp locations)
Operating altitude	up to 2 000 m
Shock resistance	20 g (11 ms) in accordance with IEC/EN60068-2-27
Vibration resistance	Acceleration up to 5 g (10 to 2 000 Hz) in accordance with IEC/EN60068-2-6
Electromagnetic compatibility (EMC)	According to IEC/EN61326 and/or IEC/EN55011 (Class A)

13.7 Process

Medium temperature range	<ul style="list-style-type: none"> ▪ -10 to +70 °C (+14 to +158 °F) ▪ Permissible short-term temperature: maximum one hour 85 °C (185 °F) every 4 hours. ▪ Permissible short-term temperature with electronics switched off: maximum one hour 100 °C (212 °F) every 4 hours.
Medium properties	Liquid, conductivity ≥ 10 µS/cm
Pressure	Max. 16 bar _{rel}

i Avoid cavitation in the process.

Magnetism and static electricity

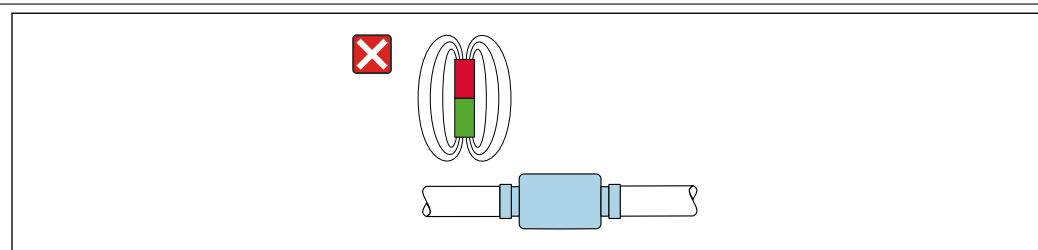

8 Avoid magnetic fields

A0046637

13.8 Mechanical construction

Measuring device with
male thread

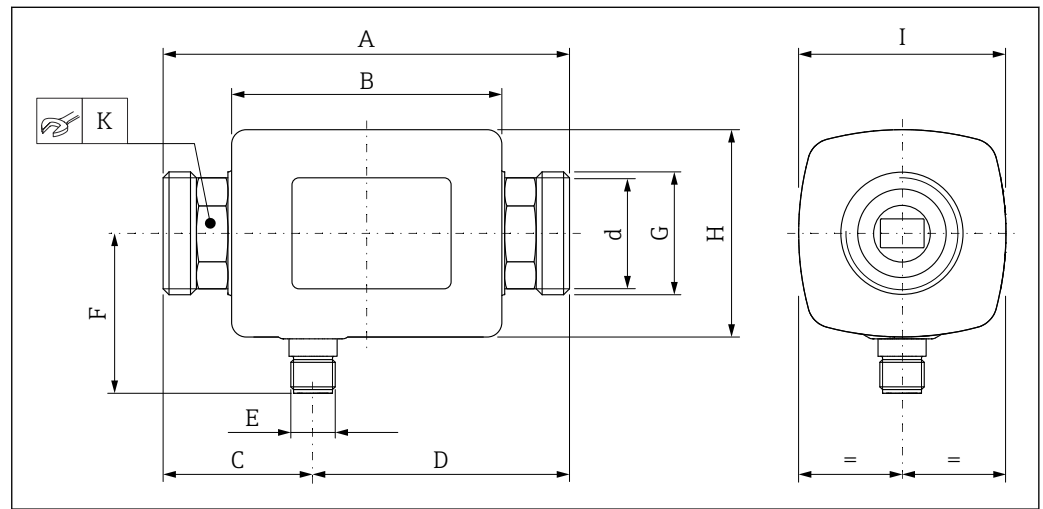

A0033012

Dimensions in SI units

DN	A [mm]	B [mm]	C [mm]	D [mm]	E	F [mm]	G	H [mm]	I [mm]	K [mm]	d [mm]
15	110	73	40.5	69.5	M12 × 1	43	G½"	56	56	SW 24	12
20	110	73	40.5	69.5	M12 × 1	43	G¾"	56	56	SW 27	15
25	110	73	40.5	69.5	M12 × 1	43	G1"	56	56	SW 27	15
50	200	113	80	120	M12 × 1	58	G2"	86	86	SW 52	43

Dimensions in US units

DN	A [in]	B [in]	C [in]	D [in]	E	F [in]	G	H [in]	I [in]	K [in]	d [in]
15	4.33	2.87	1.59	2.74	M12 × 1	43	G½"	2.2	2.2	AF 1	0.42
20	4.33	2.87	1.59	2.74	M12 × 1	43	G¾"	2.2	2.2	AF 1½/16	0.59
25	4.33	2.87	1.59	2.74	M12 × 1	43	G1"	2.2	2.2	AF 1½/16	0.59
50	7.87	4.45	3.15	4.72	M12 × 1	58	G2"	3.39	3.39	AF 2½/16	1.69

Weight in SI units

DN	[kg]
15	0.34
20	0.35
25	0.36
50	1.55

Weight in US units

DN	Weight [lbs]
15	0.75
20	0.77
25	0.79
50	3.42

Materials

Component	Material
Measuring tube	PEEK
Electrodes, temperature sensor	1.4435/316L
Process connection	1.4404/316L

Component	Material
Housing	1.4404/316L, 1.4409/CF3M
Seal	FKM or EPDM
Display window	Polycarbonate

Measuring device with female thread

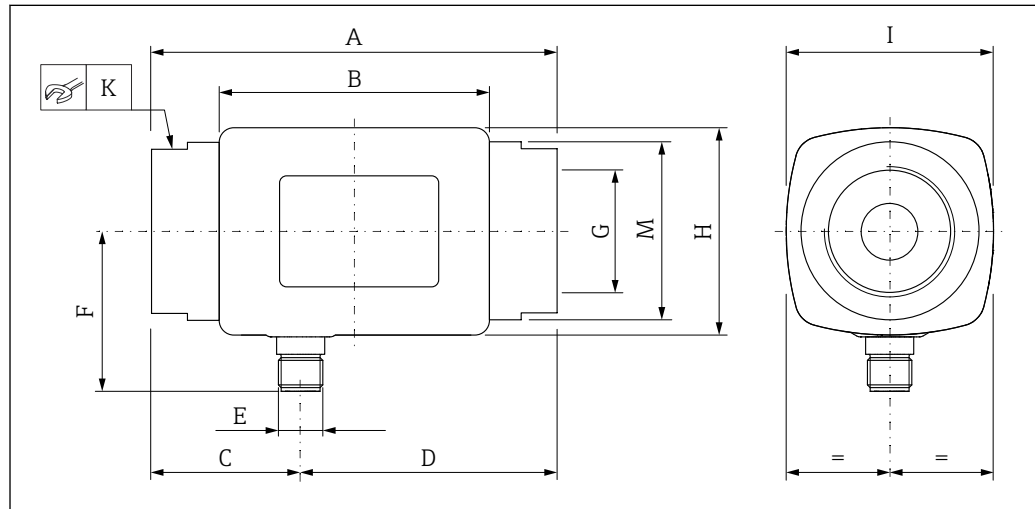

Dimensions in SI units

DN	A [mm]	B [mm]	C [mm]	D [mm]	E	F [mm]	G	H [mm]	I [mm]	K [mm]	ØM [mm]
15	110	73	40.5	69.5	M12 × 1	43	NPT½"	56	56	SW 27	29.5
20	110	73	40.5	69.5	M12 × 1	43	NPT¾"	56	56	SW 32	36
25	110	73	40.5	69.5	M12 × 1	43	NPT1"	56	56	SW 41	42
50	180	113	80	120	M12 × 1	58	NPT2"	86	86	SW 70	73.5

Dimensions in US units

DN	A [in]	B [in]	C [in]	D [in]	E	F [in]	G	H [in]	I [in]	K [in]	ØM [in]
15	4.33	2.87	1.59	2.74	M12 × 1	1.69	NPT½"	2.2	2.2	AF 1¼ ₁₆	1.16
20	4.33	2.87	1.59	2.74	M12 × 1	1.69	NPT¾"	2.2	2.2	AF 1¼	1.42
25	4.33	2.87	1.59	2.74	M12 × 1	1.69	NPT1"	2.2	2.2	AF 1⅞ ₁₆	1.65
50	7.09	4.45	2.76	4.33	M12 × 1	2.28	NPT2"	3.38	3.38	AF 2¾	2.89

Weight in SI units

DN	[kg]
15	0.34
20	0.35
25	0.36
50	1.55

Weight in US units

DN	Weight [lbs]
15	0.75
20	0.77
25	0.79
50	3.42

Materials

Component	Material
Measuring tube	PEEK
Electrodes, temperature sensor	1.4435/316L
Process connection	1.4404/316L
Housing	1.4404/316L, 1.4409/CF3M
Seal	FKM or EPDM
Display window	Polycarbonate

13.9 Operability

Local display

The device has an onsite display:

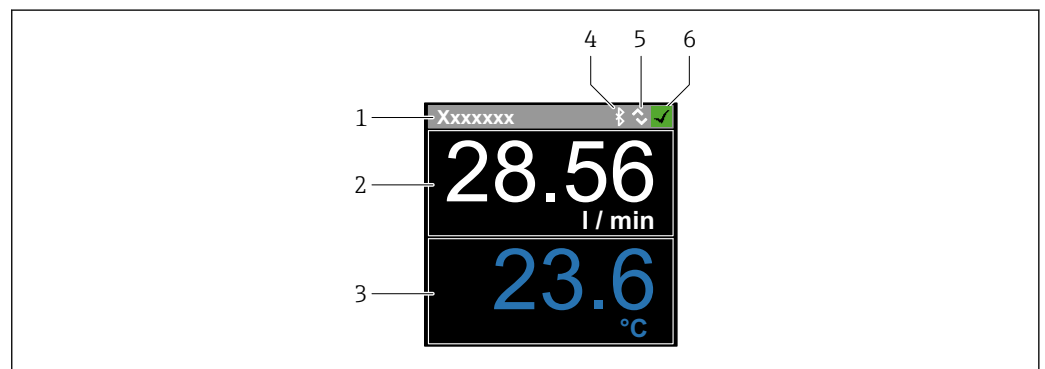

- 1 Tag name (configurable)
- 2 Measured variable 1 (configurable) with sign → 30
- 3 Measured variable 2 (configurable) with sign → 30
- 4 Active Bluetooth connection
- 5 Active I/O-Link connection
- 6 Device status

Display element

3 measured variables can be displayed (volume flow, temperature, conductivity).

i Floating point numbers are saved in IEEE754 format and displayed with single precision format. The values are entered in the decimal system, however. As a result, extremely small, insignificant differences can arise between the value entered and the floating point number displayed, depending on the numerical values.

Operation

- Via Bluetooth® wireless technology
- Via IO-Link

Digital communication

Via IO-Link

SmartBlue app

The device has a *Bluetooth*® wireless technology interface and can be operated and configured using the SmartBlue app.



- The range under reference conditions is 10 m (33 ft)
- Incorrect operation by unauthorized persons is prevented by means of encrypted communication and password encryption
- The *Bluetooth*® wireless technology interface can be disabled

13.10 Certificates and approvals

Current certificates and approvals for the product are available via the Product Configurator at www.endress.com.

1. Select the product using the filters and search field.
2. Open the product page.

The **Configuration** button opens the Product Configurator.

CE mark	<p>The device meets the legal requirements of the applicable EU Directives. These are listed in the corresponding EU Declaration of Conformity along with the standards applied.</p> <p>Endress+Hauser confirms successful testing of the device by affixing to it the CE mark.</p>
UKCA marking	<p>The device meets the legal requirements of the applicable UK regulations (Statutory Instruments). These are listed in the UKCA Declaration of Conformity along with the designated standards. By selecting the order option for UKCA marking, Endress+Hauser confirms a successful evaluation and testing of the device by affixing the UKCA mark.</p> <p>Contact address Endress+Hauser UK: Endress+Hauser Ltd. Floats Road Manchester M23 9NF United Kingdom www.uk.endress.com</p>
Radio approval	<p>The measuring device has radio approval.</p> <p> For detailed information regarding radio approval, see the appendix →  47</p>
Pressure Equipment Directive	<p>Devices not bearing this marking (without PED or UKCA) are designed and manufactured according to sound engineering practice. They meet the requirements of</p> <p>a) Art. 4 Para. 3 of the Pressure Equipment Directive 2014/68/EU or b) Part 1, Para. 8 of Statutory Instruments 2016 No. 1105.</p> <p>The scope of application is indicated</p> <p>a) in diagrams 6 to 9 in Annex II of the Pressure Equipment Directive 2014/68/EU or b) Schedule 3, Para. 2 of Statutory Instruments 2016 No. 1105.</p>
cUL _{US} listing	<p>The measuring device is UL-listed.</p>
Drinking water approval	<p>Availability, see Applicator: https://portal.endress.com/webapp/applicator</p>

14 Appendix

14.1 Radio approvals

14.1.1 Argentina



CNC ID: C-22455

14.1.2 Brazil

ADENDO AO MANUAL

Modelo: Picomag



A0037714

Para maiores informações, consulte o site da ANATEL: www.gov.br/anatel/pt-br

Este equipamento não tem direito à proteção contra interferência prejudicial e não pode causar interferência em sistemas devidamente autorizados.



14.1.3 Europe

This device meets the requirements of the Telecommunications Directive RED 2014/53/EU.

14.1.4 India

ETA Certificate No: ETA - 1707/18-RLO(NE)

14.1.5 Indonesia

<p>76485/SDPPI/2021 4962</p> 	 <p>Dilarang melakukan perubahan spesifikasi yang dapat menimbulkan gangguan fisik dan/atau elektromagnetik terhadap lingkungan sekitarnya.</p>
--	--

14.1.6 Canada and United States

English

This device complies with Part 15 of the FCC Rules and with Industry Canada licence-exempt RSS standard(s).

Operation is subject to the following two conditions:

- This device may not cause harmful interference, and
- This device must accept any interference received, including interference that may cause undesired operation.

 Changes or modifications made to this equipment not expressly approved by Endress+Hauser Flowtec AG may void the user's authorization to operate this equipment.

Français

Le présent appareil est conforme aux CNR d'industrie Canada applicables aux appareils radio exempts de licence.



L'exploitation est autorisée aux deux conditions suivantes :

- L'appareil ne doit pas produire de brouillage, et
- L'utilisateur de l'appareil doit accepter tout brouillage radioélectrique subi, même si le brouillage est susceptible d'en compromettre le fonctionnement.

 Les changements ou modifications apportés à cet appareil non expressément approuvés par Endress+Hauser Flowtec AG peuvent annuler l'autorisation de l'utilisateur d'opérer cet appareil.

14.1.7 Mexico

La operación de este equipo está sujeta dos condiciones: (1) es posible que este equipo o dispositivo no cause interferencia perjudicial y (2) este equipo o dispositivo debe aceptar cualquier interferencia, incluyendo la que pueda causar su operación no deseada.

  <p>A0034100</p>	<p>IFT No.: RCPENPI21-3683</p>
---	--------------------------------

14.1.8 Republic of Korea

KC 인증

적합성평가정보

R-C-EH7-Picomag

상호 : 한국엔드레스하우저 주식회사

기자재명칭(모델명): 특정소출력 무선기기(무선데이터통신시스템용무선기기)

/ Picomag

제조국 및 제조국가 : Endress+Hauser Flowtec AG / 프랑스

제조년월 : 제조년월로 표기

*사용자안내문

이 기기는 업무용 환경에서 사용할 목적으로 적합성평가를 받은 기기로서 가정용 환경에서 사용하는 경우 전파간섭의 우려가 있습니다.

14.1.9 Singapore

Complies with IMDA Standards DA108204

14.1.10 Taiwan

低功率電波輻射性電機管理辦法

第十二條	經型式認證合格之低功率射頻電機，非經許可，公司、商號或使用者均不得擅自變更頻率、加大功率或變更原設計之特性及功能。
第十四條	低功率射頻電機之使用不得影響飛航安全及干擾合法通信；經發現有干擾現象時，應改善至無干擾時方得繼續使用。前項合法通信，指依電信法規定作業之無線電通信。低功率射頻電機須忍受合法通信或工業、科學及醫療用電波輻射性電機設備之干擾。
產品名稱	Endress + Hauser
產品型號	Picomag
產地	瑞士
製造商	Endress + Hauser Flowtec AG

14.1.11 Thailand

เครื่องโทรคมนาคมและอุปกรณ์นี้ มีความสอดคล้องตามข้อกำหนดของ กสทช.

(This telecommunication equipment is in compliance with NBTC requirements.)



ผู้ใดมิไว้ในครอบครอง หรือ ใช้ซึ่งเครื่องวิทยุคมนาคมหรือตั้งสถานีวิทยุคมนาคมนี้ ต้องได้รับใบอนุญาตจากเจ้าพนักงานผู้ออกใบอนุญาต หากฝ่าฝืน มาตรา 6 หรือมาตรา 11 มีความผิดตามมาตรา 23 แห่งพระราชบัญญัติวิทยุคมนาคม พ.ศ. 2498 ต้องระวางโทษปรับไม่เกินหนึ่งแสนบาท หรือจำคุกไม่เกินห้าปี หรือทั้งปรับทั้งจำ



nabp. | โทรคมนาคม

กำกับดูแลเพื่อประชาชน

Call Center 1200 (Inswr)

A0041612

14.1.12 United Arab Emirates

TRA Registered ER68711/19

14.1.13 Other countries

Other national approvals are available on request.

14.2 IO-Link process data

14.2.1 Data structure

Bit number	119... 112	111... 104	103... 96	95... 88	87... 80	79... 72	71... 64	63... 56	55... 48	47... 40	39... 32	31... 24	23... 16	15... 8	7...0
Data	Conductivity in $\mu\text{S}/\text{cm}$				Totalizer in l				Volume flow in l/s				Temperature in $\frac{1}{10}^\circ\text{C}$		Status
Data type	32-bit floating point number with single precision (IEEE 754)				32-bit floating point number with single precision (IEEE 754)				32-bit floating point number with single precision (IEEE 754)				16-bit two's complement		8-bit

Data structure of the status bits 7 to 0

Bit	Description
0	Switches once per sampling rate
1	Reserved
2	Current status S-Out 1
3	Current status S-Out 2
4	Reserved
5	Reserved
6	Reserved
7	Reserved

14.2.2 Diagnostic information

Diagnostic code		Display text	Coding (hex)	PDValid Validity	Priority
Status NE 107	Diagnostic number				
	-	SYSTEM OK	0x0000	1	1
F	181	COIL CIRC.FAIL.	0x5000	0	2
F	180	TEMP.CIRC.FAIL.	0x5000	0	3
F	201	DECICE FAIL.	0x5000	0	4
F	283	MEMORY FAIL.	0x8C00	0	5
C	446	I/O 1 OVERLOAD	0x180C	1	6
C	447	I/O 2 OVERLOAD	0x180C	1	7
C	485	SIMULATION ACT.	0x8C01	1	8
C	453	FLOW OVERRIDE	0x180D	1	9
S	441	I-OUT 1 RANGE	0x180A	1	10
S	444	U-OUT 1 RANGE	0x1809	1	11
S	443	P-OUT 1 RANGE	0x180B	1	12
S	442	I-OUT 2 RANGE	0x180A	1	13
S	445	U-OUT 2 RANGE	0x1809	1	14
S	962	EMPTY PIPE	0x180E	1	15
S	834	TEMPERAT. RANGE	0x8C20	1	16

14.3 IO-Link ISDU parameter list

The individual parts of a parameter description are described in the following section:

Designation	ISDU (hex)	ISDU (dec)	Size (byte)	Data type	Access	Value range	Factory setting	Range limits
Identification								
Device Tag First 10 characters displayed (starting from left)	0x0018	24	32 (max.)	string	r/w		EH_DMA_XXZZ	
Device Name	0x0012	18	16 (max.)	string	r		Picomag	
Device ID1	0x0009	9	1	uint	r		0x01	
Device ID2	0x000A	10	1	uint	r		0x01	
Device ID3	0x000B	11	1	uint	r		0x00	
Vendor Name	0x0010	16	32 (max.)	string	r		Endress+Hauser	
Vendor ID1	0x0007	7	1	uint	r		0x00	
Vendor ID2	0x0008	8	1	uint	r		0x11	
Device Serial No. e.g. (YMXXXZZZ)	0x0015	21	11 (max.)	string	r		see nameplate	
Firmware Version e.g. 01.00.00	0x0017	23	8 (max.)	string	r			
Order Code e.g. DMA15-AAAAA1	0x0102	258	18 (max.)	string	r		see nameplate	
Device Type	0x0100	256	2	uint	r		0x94FF	
Diagnostics								
Actual Diagnostics e.g. C485 (= SIMULATION ACT.)	0x0104	260	4	string	r			
Last Diagnostics e.g. S962 (= EMPTY PIPE)	0x0105	261	4	string	r			
Simulation Proc. Var.	0x015F	351	2	uint	r/w	enable=1 disable=0		
Sim.Proc.Var.Value Volumeflow Unit selection list from Unit Volumeflow	0x0166	358	4	float	r/w		0.0	-10 ⁶ 10 ⁶
Sim.Proc.Var.Value Temperature Unit selection list from Unit Temperature	0x0168	360	4	float	r/w		0.0	-10 ⁴ 10 ⁴
Sim.Proc.Var.Value Conductivity Unit selection list from Unit Conductivity	0x0167	359	4	float	r/w		0.0	0 10 ⁶
Measured Values								
Volumeflow Current volume flow measured value	0x0161	353	4	float	r			
Temperature Current temperature measured value	0x0163	355	4	float	r			
Conductivity Current conductivity measured value	0x0164	365	4	float	r			
Totalizer Current totalizer measured value	0x0169	361	4	float	r/w		0.0	

Designation	ISDU (hex)	ISDU (dec)	Size (byte)	Data type	Access	Value range	Factory setting	Range limits
Totalizer Reset	0x016A	362	2	uint	w	cancel=0 reset=1	cancel	
System Units								
Unit Volumeflow	0x0226	550	2	uint	r/w	l/s=0 l/h=5 fl. oz/min=4 m ³ /h=1 l/min=2 Usgpm=3	l/min	
Unit Volume	0x0227	551	2	uint	r/w	ml=0 USozf=1 l=2 m ³ =3 Usgal=4	ml	
Unit Temperature	0x0228	552	2	uint	r/w	°C=0 °F=1	°C	
Unit Conductivity	0x0229	553	2	uint	r/w	µS/cm=0 S/m=1 mS/cm=2	µS/cm=0	
Unit Totalizer	0x016B	363	2	uint	r/w	USozf=1 l=2 m ³ =3 Usgal=4 kl=5 Ml=6 kUsg=7	m ³	
Sensor								
Install. Direction In relation to direction of arrow on the device	0x015E	350	2	uint	r/w	forward=0 reverse=1	forward	
Low Flow Cut Off The flow rate below the selected value is zero Unit selection list from Unit Volumeflow	0x0160	352	4	float	r/w		0.4/0.75/1.2/5.0 l/min	0 10 ⁶
Damping Volume flow damping via the PT1 element Unit: s	0x01A4	420	4	float	r/w		0 s	0 100

Designation	ISDU (hex)	ISDU (dec)	Size (byte)	Data type	Access	Value range	Factory setting	Range limits
Output 1								
Operating Mode IO-Link is set if connected to a master	0x01F4	500	2	uint	r/w	P-Out=0 I-Out=1 S-In=2 S-Out=3 IO-Link=4 U-Out=5 off=6	IO-Link	
Current output I-Out 1								
I - OUT Assign	0x0258	600	2	uint	r/w	off=0 volume flow=1 temperature=2 conductivity=4	volume flow	
Q-Start-Value ASP ¹⁾ for volume flow Unit selection list from Unit Volumeflow	0x0259	601	4	float	r/w		0 l/min	-9.9·10 ⁹ 9.9·10 ⁹
Q-End-Value AEP ²⁾ for volume flow Unit selection list from Unit Volumeflow	0x025A	602	4	float	r/w		25/50/100/750 l/min	-9.9·10 ⁹ 9.9·10 ⁹
T-Start-Value ASP ¹⁾ for temperature Unit selection list from Unit Temperature	0x025F	607	4	float	r/w		-10 °C	-9.9·10 ⁹ 9.9·10 ⁹
T-End-Value AEP ²⁾ for temperature Unit selection list from Unit Temperature	0x0260	608	4	float	r/w		+70 °C	-9.9·10 ⁹ 9.9·10 ⁹
s-Start-Value ASP ¹⁾ for conductivity Unit selection list from Unit Conductivity	0x025D	605	4	float	r/w		0	-9.9·10 ⁹ 9.9·10 ⁹
s-End-Value AEP ²⁾ for conductivity Unit selection list from Unit Conductivity	0x025E	606	4	float	r/w		1000	-9.9·10 ⁹ 9.9·10 ⁹

Designation	ISDU (hex)	ISDU (dec)	Size (byte)	Data type	Access	Value range	Factory setting	Range limits
Pulse output P-Out								
Pulse Value Unit selection list from Unit Volume	0x03E8	1000	4	float	r/w		0.5/1.0/2.0/10.0 ml	10 ⁻⁹ 9.9·10 ⁹
Switch output S-Out 1								
Switch Polarity	0x032B	811	2	uint	r/w	PNP=0 NPN=1	PNP	
Switch Function	0x0320	800	2	uint	r/w	alarm=0 off=1 on=2 lim.vol.flow=3, lim.temp.=4 lim.vol.=5 lims=11 win.vol.flow=6 win.temp.=7 win.vol.=8 wins=13 epd=9	alarm	
Q-ON-Value Unit selection list from Unit Volumeflow	0x0321	801	4	float	r/w		20/40/80/600 l/min	-9.9·10 ⁹ 9.9·10 ⁹
Q-OFF-Value Unit selection list from Unit Volumeflow	0x0322	802	4	float	r/w		15/30/60/450 l/min	-9.9·10 ⁹ 9.9·10 ⁹
T-ON-Value Unit selection list from Unit Temperature	0x0327	807	4	float	r/w		+ 60 °C	-9.9·10 ⁹ 9.9·10 ⁹
T-OFF-Value Unit selection list from Unit Temperature	0x0328	808	4	float	r/w		+ 50 °C	-9.9·10 ⁹ 9.9·10 ⁹
V-ON-Value Unit selection list from Unit Totalizer	0x0329	809	4	float	r/w		0.2/0.4/0.8/6.0 m ³	-9.9·10 ⁹ 9.9·10 ⁹
V-OFF-Value Unit selection list from Unit Totalizer	0x032A	810	4	float	r/w		0.15/0.3/0.6/4.5 m ³	-9.9·10 ⁹ 9.9·10 ⁹
s-ON-Value Unit selection list from Unit Conductivity	0x0325	805	4	float	r/w		500	-9.9·10 ⁹ 9.9·10 ⁹
s-OFF-Value Unit selection list from Unit Conductivity	0x0326	806	4	float	r/w		200	-9.9·10 ⁹ 9.9·10 ⁹
Voltage output U-Out 1								
U - OUT Assign	0x02BC	700	2	uint	r/w	off=0 volume flow=1 temperature=2 conductivity=4	volume flow	
Q-Start-Value ASP ¹⁾ for volume flow Unit selection list from Unit Volumeflow	0x02BD	701	4	float	r/w		0 l/min	
Q-End-Value AEP ²⁾ for volume flow Unit selection list from Unit Volumeflow	0x02BE	702	4	float	r/w		25/50/100/750 l/min	

Designation	ISDU (hex)	ISDU (dec)	Size (byte)	Data type	Access	Value range	Factory setting	Range limits
T-Start-Value ASP ¹⁾ for temperature Unit selection list from Unit Temperature	0x02C3	707	4	float	r/w		-10 °C	
T-End-Value AEP ²⁾ for temperature Unit selection list from Unit Temperature	0x02C4	708	4	float	r/w		+70 °C	
s-Start-Value ASP ¹⁾ for conductivity Unit selection list from Unit Conductivity	0x02C1	705	4	float	r/w		0 µS/cm	
s-End-Value AEP ²⁾ for conductivity Unit selection list from Unit Conductivity	0x02C2	706	4	float	r/w		1000 µS/cm	
Digital input D-In 1								
D-IN Polarity	0x0385	901	2	uint	r/w	low=0 high=1	high	
D-IN Function	0x0384	900	2	uint	r/w	off=0 res.tot.=1 zero ret.=2	res.tot.	
IO-Link								
IO-LINK Vendor Name	0x0010	16	32 (max.)	string	r		Endress+Hauser	
IO-LINK Product Name	0x0012	18	16 (max.)	string	r		Picomag	
IO-LINK RevisionID	0x0004	4	1	uint	r		0x11	
Output 2								
Operating Mode	0x01F5	501	2	uint	r/w	I-Out=1 S-In=2 S-Out=3 U-Out=5 off=6	off	
Current output I-Out 2								
I - OUT Assign	0x028A	650	2	uint	r/w	off=0 volume flow=1 temperature=2	temperature	
Q-Start-Value ASP ¹⁾ for volume flow Unit selection list from Unit Volumeflow	0x028B	651	4	float	r/w		0 l/min	
Q-End-Value AEP ²⁾ for volume flow Unit selection list from Unit Volumeflow	0x028C	652	4	float	r/w		25/50/100/750 l/min	
T-Start-Value ASP ¹⁾ for temperature Unit selection list from Unit Temperature	0x0291	657	4	float	r/w		-10 °C	
T-End-Value AEP ²⁾ for temperature Unit selection list from Unit Temperature	0x0292	658	4	float	r/w		+70 °C	
s-Start-Value ASP ¹⁾ for conductivity Unit selection list from Unit Conductivity	0x028F	655	4	float	r/w		0	-9.9·10 ⁹ 9.9·10 ⁹

Designation	ISDU (hex)	ISDU (dec)	Size (byte)	Data type	Access	Value range	Factory setting	Range limits
s-End-Value AEP ²⁾ for conductivity Unit selection list from Unit Conductivity	0x0290	656	4	float	r/w		1000	-9.9·10 ⁹ 9.9·10 ⁹
Switch output S-Out 2								
Switch Polarity	0x035D	861	2	uint	r/w	PNP=0 NPN=1	PNP	
Switch Function	0x0352	850	2	uint	r/w	alarm=0 off=1 on=2 lim.vol.flow=3 lim.temp.=4 lim.vol.=5, win.vol.flow=6 lims=11 win.temp.=7 win.vol.=8 wins=13 epd=9	alarm	
Q-ON-Value Unit selection list from Unit Volumeflow	0x0353	851	4	float	r/w		20/40/80/600 l/min	
Q-OFF-Value Unit selection list from Unit Volumeflow	0x0354	852	4	float	r/w		15/30/60/450 l/min	
T-ON-Value Unit selection list from Unit Temperature	0x0359	857	4	float	r/w		+ 60 °C	
T-OFF-Value Unit selection list from Unit Temperature	0x035A	858	4	float	r/w		+ 50 °C	
V-ON-Value Unit selection list from Totalizer	0x035B	859	4	float	r/w		0.2/0.4/0.8/6.0 m ³	
V-OFF-Value Unit selection list from Totalizer	0x035C	860	4	float	r/w		0.15/0.3/0.6/4.5 m ³	
s-ON-Value Unit selection list from Conductivity	0x0357	855	4	float	r/w		500	
s-OFF-Value Unit selection list from Conductivity	0x0358	856	4	float	r/w		200	
Voltage output U-Out 2								
U - OUT Assign	0x02EE	750	2	uint	r/w	off=0 volume flow=1 temperature=2	temperature	
Q-Start-Value ASP ¹⁾ for volume flow Unit selection list from Unit Volumeflow	0x02EF	751	4	float	r/w		0 l/min	
Q-End-Value AEP ²⁾ for volume flow Unit selection list from Unit Volumeflow	0x02F0	752	4	float	r/w		25/50/100/750 l/min	
T-Start-Value ASP ¹⁾ for temperature from Unit Temperature	0x02F5	757	4	float	r/w		-10 °C	

Designation	ISDU (hex)	ISDU (dec)	Size (byte)	Data type	Access	Value range	Factory setting	Range limits
T-End-Value AEP ²⁾ for temperature from Unit Temperature	0x02F6	758	4	float	r/w		+70 °C	
s-Start-Value ASP ¹⁾ for temperature from Conductivity	0x02F3	755	4	float	r/w		0 µS/cm	
s-End-Value AEP ²⁾ for temperature from Conductivity	0x02F4	756	4	float	r/w		1000 µS/cm	
Digital input D-In 2								
D-IN Polarity	0x0395	917	2	uint	r/w	low=0 high=1	high	
D-IN Function	0x0394	916	2	uint	r/w	off=0 res.tot.=1 zero ret.=2	res.tot.	
Display								
Display Layout	0x01C3	451	2	uint	r/w	QV=0 QT=1 Qs=3 VT=2, Vs=4 Ts=5 QVTs=6 QVTs_m=7	QT	
Display Rotation	0x01C4	452	2	uint	r/w	0 °=0 90 °=1 180 °=2 270 °=3 auto=4	Auto	
Display Backlight	0x01C2	450	2	uint	r/w	0...100	50	
Bluetooth configuration								
Bluetooth Function	0x041A	1050	2	uint	r/w	on=1 off=0	on	
Bluetooth Tx Pwr Level	0x041B	1051	2	uint	r	0...4		
Bluetooth Conn. Status	0x041C	1052	1	uint	r			
Administration								
Set Access Code Define the access code	0x0108	264	2	uint	w		0000	
Access Code Enter the access code	0x0107	263	2	uint	w			
Reset Device	0x010E	270	2	uint	w	cancel=0 restore fact.=1 restart=4	cancel	
Product Specific Process Values								
Status IO 1	0x0386	902	2	uint	r	low=0 high=1		
Status IO 2	0x0396	918	2	uint	r	low=0 high=1		

1) Analog Start Point

2) Analog End Point

Index

A

About this document	5
Accessories	39
Appendix	47
Application	
Media	8

B

Basic safety instructions	8
Bidirectional flow measurement (Q), temperature measurement (T)	25, 28

C

CE mark	9, 46
Commissioning	22
Configuring system units	22
Configuring the current output	24
Configuring the digital input	28
Configuring the display	30
Configuring the IO modules	24
Configuring the measuring device	22
Configuring the pulse output	25
Configuring the voltage output	27
Connecting requirements	16
Connecting the measuring device	19
Current output configuration version	18
Current version data for the device	21

D

Data management	31
Declaration of Conformity	9
Device information	37
Device master file	21
Diagnostic behavior	36
Diagnostic information on local display	36
Diagnostic message	36
Diagnostics and troubleshooting	35
Digital input configuration version	18
Dimensions in SI units	43, 44
Dimensions in US units	43
Document function	5
Documentation	6
Drinking water approval	46

E

Electrical connection	16
---------------------------------	----

F

Field of application	
Residual risks	8
Firmware history	38

I

Identification	22
Identifying the measuring device	11
Incoming acceptance	11
Inlet and outlet runs	14

Inspection

Received goods	11
Intended use	8
IO-Link configuration version	19

M

Magnetism	42
Materials	43, 45
Mounting	14
Mounting location	14
Mounting position	14
Mounting requirements	14
Mounting the measuring device	14

O

Operation	33
Operation options	20
SmartBlue app	20
Operational safety	9
Overview of device description files	21
Overview of diagnostic events	37
Overview of the operating menu	22

P

Packaging disposal	13
Pin assignment, device plug	16
Post-connection check	19
Pressure Equipment Directive	46
Product safety	9

R

Radio approval	46
Radio approvals	47
Registered trademarks	6
Requirements for connecting cable	16
Requirements for personnel	8

S

Security	31
Setting the installation direction and measurement	23
Static electricity	42
Storage conditions	13
Storage temperature	13
Switch output configuration version	17
Switch/pulse output configuration version	17
Switching ON the measuring device	22
Symbols used	5
System integration	21

T

Technical data	41
Certificates and approvals	46
Environment	42
Input	41
Installation	42
Mechanical construction	43, 44
Operability	45

Output	41
Performance characteristics	41
Power supply	41
Process	42
Temperature range	
Storage temperature	13
Tools	
Transport	13
Totalizer	29
Transporting the measuring device	13
Troubleshooting	
General	35
U	
UKCA marking	46
Unidirectional flow measurement (Q), conductivity measurement	25, 28
Using the measuring device	
Borderline cases	8
Incorrect use	8
V	
Voltage output configuration version	18
W	
W@M Device Viewer	11
Weight	
Transport (notes)	13
Weight in SI units	43, 44
Weight in US units	43, 44
Workplace safety	8



71552010

www.addresses.endress.com
