

ISOM871x 3.75-kV_{RMS}, High-Speed Single-Channel Opto-Emulator

1 Features

- Drop-in replacement and pin-to-pin upgrade to industry standard high-speed digital optocouplers
- Single-channel diode-emulator input
- Output options:
 - ISOM8710: CMOS
 - ISOM8711: Open-collector
- Wide supply range (V_{CC}): 2.7 V to 5.5 V
- High data rate: up to 25 Mbps
 - Maximum propagation delay: 52 ns
 - Maximum pulse width distortion: 17 ns
 - Maximum propagation delay skew: 15 ns
- Robust isolation barrier:
 - Isolation rating: up to 3750- V_{RMS}
 - Working voltage: 500- V_{RMS}
 - Surge capability: up to 10-kV
 - Minimum transient immunity: ± 125 -kV/ μ s
- Wide temperature range: -40°C to $+125^{\circ}\text{C}$
- Small SOIC-5 package
- Safety-related certifications planned:
 - UL 1577 recognition, 3750- V_{RMS} isolation
 - DIN EN IEC 60747-17 (VDE 0884-17) conformity per VDE
 - IEC 62368-1, IEC 61010-1 certifications
 - CQC GB 4943.1 certification

2 Applications

- [Power supplies](#)
- [Grid, Electricity meter](#)
- [Motor drives](#)
- [Factory automation and control](#)
- [Building automation](#)
- [Lighting](#)
- [Appliances](#)

3 Description

The ISOM871x devices are single-channel opto-emulators with diode-emulator inputs and digital outputs. The devices are pin-compatible and drop-in replaceable for many traditional optocouplers, allowing enhancement to industry-standard packages with no PCB redesign. These devices can transmit data rates up to 25 Mbps and can output 3.3-V and 5-V signals with two logic-output options: CMOS-compatible output (ISOM8710) and open-collector output (ISOM8711).

ISOM871x opto-emulators offer significant reliability and performance advantages compared to optocouplers, including high common mode transient immunity (CMTI), low propagation delay, small pulse width distortion (PWD), low power consumption, wider temperature ranges, and tight process controls resulting in small part-to-part skew. Since there is no aging effect to compensate for, the emulated diode-input stage consumes less power than optocouplers. ISOM871x devices are offered in a small SOIC-5 package, supporting a 3.75-kV_{RMS} isolation rating. Its high performance and reliability enable its use in motor drives, I/O modules in industrial controllers, factory automation applications, and more. To learn more about the advantages of opto-emulator technology, please read [Introduction to Opto-emulators](#).

Device Information

PART NUMBER	OUTPUT STAGE	PACKAGE SIZE ⁽¹⁾
ISOM8710	CMOS	3.51 mm × 7 mm
ISOM8711	OPEN COLLECTOR	

(1) The package size (length × width) is a nominal value and includes pins, where applicable.

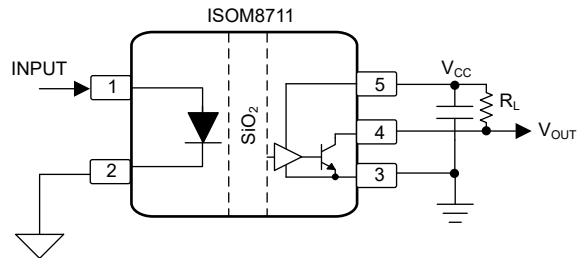
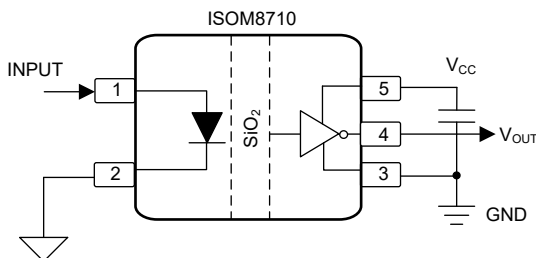

Simplified Application Examples



Table of Contents

1 Features	1	9 Detailed Description	18
2 Applications	1	9.1 Overview.....	18
3 Description	1	9.2 Functional Block Diagram.....	18
4 Revision History	2	9.3 Feature Description.....	19
5 Device Comparison	3	9.4 Device Functional Modes.....	19
6 Pin Configuration and Functions	3	10 Application and Implementation	20
7 Specifications	4	10.1 Application Information.....	20
7.1 Absolute Maximum Ratings.....	4	10.2 Typical Application.....	20
7.2 ESD Ratings.....	4	10.3 Power Supply Recommendations.....	24
7.3 Recommended Operating Conditions.....	5	10.4 Layout.....	24
7.4 Thermal Information.....	6	11 Device and Documentation Support	25
7.5 Power Ratings.....	6	11.1 Documentation Support.....	25
7.6 Insulation Specifications.....	7	11.2 Receiving Notification of Documentation Updates..	25
7.7 Safety-Related Certifications.....	8	11.3 Support Resources.....	25
7.8 Safety Limiting Values.....	8	11.4 Trademarks.....	25
7.9 Electrical Characteristics—DC	9	11.5 Electrostatic Discharge Caution.....	25
7.10 Switching Characteristics, ISOM8710.....	9	11.6 Glossary.....	25
7.11 Switching Characteristics, ISOM8711.....	9	12 Mechanical, Packaging, and Orderable	
7.12 Typical Characteristics.....	11	Information	26
8 Parameter Measurement Information	16		

4 Revision History

NOTE: Page numbers for previous revisions may differ from page numbers in the current version.

Changes from Revision B (July 2023) to Revision C (September 2023)	Page
• Made editorial corrections and modifications throughout the document.....	1
• Updated ISOM871x images to read "SiO ₂ " instead of "ISOLATION" throughout the document.....	1
• Updated ISOM8711 device status to Production Data.....	1
• Updated application waveforms.....	23

Changes from Revision A (June 2023) to Revision B (July 2023)	Page
• Updated ISOM8711 device status to Advanced Information.....	1

Changes from Revision * (March 2023) to Revision A (June 2023)	Page
• Updated device status to Production Data.....	1

5 Device Comparison

Table 5-1. Device Comparison Table

DEVICE NAME	OUTPUT STAGE TYPE	CHANNEL COUNT	PACKAGE	NOMINAL BODY SIZE (mm)
ISOM8710	CMOS	1	DFF (SOIC, 5)	3.51 mm x 4.8 mm
ISOM8711	OPEN COLLECTOR			

6 Pin Configuration and Functions

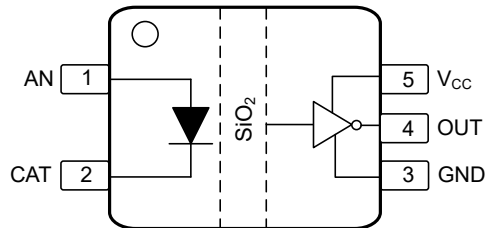

Figure 6-1. ISOM8710 DFF Package, 5-Pin SOIC (Top View)

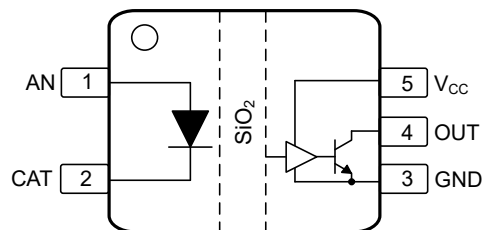

Figure 6-2. ISOM8711 DFF Package, 5-Pin SOIC (Top View)

Table 6-1. Pin Functions

PIN		TYPE ⁽¹⁾	Description
NAME	NO.		
AN	1	I	Anode connection of diode emulator
CAT	2	O	Cathode connection of diode emulator
GND	3	GND	Ground reference for V_{CC} and OUT
OUT	4	O	Digital data output. For ISOM8711, pull this pin up to V_{CC} using a resistor, R_L .
V_{CC}	5	P	Output power supply

(1) I = input, O = output, P = power, GND = ground

7 Specifications

7.1 Absolute Maximum Ratings

Over operating junction temperature range (unless otherwise noted).⁽¹⁾

		MIN	MAX	UNIT
Supply voltage ⁽²⁾	V _{CC}	-0.3	6	V
Input reverse voltage ⁽³⁾	V _R		5	V
Output collector voltage, ISOM8711 only	V _{OC}	-0.3	V _{CC} + 0.5	V
Input forward current	I _F		25	mA
Peak transient input current ⁽⁴⁾	I _{FT}		1	A
Output current, ISOM8710 only	I _O	-15	15	mA
Output collector current, ISOM8711 only	I _O		50	mA
Input power dissipation	P _{DI}		75	mW
Output collector power dissipation, ISOM8711 only	P _{DO}		85	mW
Operating junction temperature	T _J		150	°C
Storage temperature	T _{stg}	-65	150	°C

- (1) Operation outside the *Absolute Maximum Ratings* may cause permanent device damage. *Absolute Maximum Ratings* do not imply functional operation of the device at these or any other conditions beyond those listed under *Recommended Operating Conditions*. If used outside the *Recommended Operating Conditions* but within the *Absolute Maximum Ratings*, the device may not be fully functional, and this may affect device reliability, functionality, performance, and shorten the device lifetime.
- (2) All voltage values except differential I/O bus voltages are with respect to the local ground potential and are peak voltage values
- (3) Input reverse voltage is measured from CAT pin with respect to the AN pin
- (4) <1 μs pulse width, 300 pulses per second

7.2 ESD Ratings

			VALUE	UNIT
V _(ESD)	Electrostatic discharge	Human body model (HBM), per ANSI/ESDA/JEDEC JS-001 ⁽¹⁾	±2000	V
		Charged device model (CDM), per JEDEC specification JESD22-C101 ⁽²⁾	±1500	

- (1) JEDEC document JEP155 states that 500-V HBM allows safe manufacturing with a standard ESD control process.
- (2) JEDEC document JEP157 states that 250-V CDM allows safe manufacturing with a standard ESD control process.

7.3 Recommended Operating Conditions

		MIN	NOM	MAX	UNIT
V _{CC}	Supply voltage	2.7		5.5	V
V _{F(OFF)}	Input OFF-state voltage	0		0.8	V
I _{F(ON)}	Input ON-state forward current	2		20	mA
I _{F(OFF)}	Input OFF-state forward current ⁽¹⁾	0		250	μA
I _{OH}	HIGH-state output current	-4			mA
I _{OL}	LOW-state output current, ISOM8710 only			4	mA
I _{OS}	LOW-state open-collector sink current, ISOM8711 only			13	mA
DR	Data rate at 2 mA ≤ I _F < 3 mA	0		5	Mbps
	Data rate at 3 mA ≤ I _F < 6 mA	0		10	Mbps
	Data rate at I _F ≥ 6 mA	0		25	Mbps
T _J	Junction temperature	-40		130	°C
T _A	Ambient temperature	-40		125	°C

(1) The OFF condition is also specified by V_F ≤ 0.8 V.

7.4 Thermal Information

THERMAL METRIC ⁽¹⁾		ISOM871x	UNIT
		DFF (SOIC)	
		5 PINS	
$R_{\theta JA}$	Junction-to-ambient thermal resistance	215.9	°C/W
$R_{\theta JC(top)}$	Junction-to-case (top) thermal resistance	124.7	°C/W
$R_{\theta JB}$	Junction-to-board thermal resistance	156.9	°C/W
Ψ_{JT}	Junction-to-top characterization parameter	91.5	°C/W
Ψ_{JB}	Junction-to-board characterization parameter	154.2	°C/W
$R_{\theta JC(bot)}$	Junction-to-case (bottom) thermal resistance	—	°C/W

(1) For more information about traditional and new thermal metrics, see the [Semiconductor and IC Package Thermal Metrics application report](#).

7.5 Power Ratings

PARAMETER		TEST CONDITIONS	MIN	TYP	MAX	UNIT
P_D	Maximum power dissipation (both sides)	$I_F = 20 \text{ mA}$, $V_{CC} = 5.5 \text{ V}$, $T_J = 150^\circ\text{C}$, $C_L = 15 \text{ pF}$, Input a 2-MHz 50% duty cycle square wave			70	mW
P_{D1}	Maximum power dissipation (side-1)				50	mW
P_{D2}	Maximum power dissipation (side-2)				20	mW

7.6 Insulation Specifications

PARAMETER		TEST CONDITIONS	VALUE	UNIT
			5-DFF	
IEC 60664-1				
CLR	External clearance ⁽¹⁾	Side 1 to side 2 distance through air	>5	mm
CPG	External creepage ⁽¹⁾	Side 1 to side 2 distance across package surface	>5	mm
DTI	Distance through the insulation	Minimum internal gap (internal clearance)	>17	μm
CTI	Comparative tracking index	IEC 60112; UL 746A	>400	V
	Material Group	According to IEC 60664-1	II	
	Overvoltage category per IEC 60664-1	Rated mains voltage ≤ 150 V _{RMS}	I-IV	
		Rated mains voltage ≤ 300 V _{RMS}	I-IV	
		Rated mains voltage ≤ 600 V _{RMS}	I-III	
DIN EN IEC 60747-17 (VDE 0884-17)⁽²⁾				
V _{IORM}	Maximum repetitive peak isolation voltage	AC voltage (bipolar)	707	V _{PK}
V _{IOWM}	Maximum isolation working voltage	AC voltage (sine wave); time-dependent dielectric breakdown (TDDb) test	500	V _{RMS}
		DC voltage	707	V _{DC}
V _{IOTM}	Maximum transient isolation voltage	V _{TEST} = V _{IOTM} , t = 60 s (qualification); V _{TEST} = 1.2 × V _{IOTM} , t = 1 s (100% production)	5303	V _{PK}
V _{IMP}	Maximum impulse voltage ⁽³⁾	Tested in air, 1.2/50-μs waveform per IEC 62368-1	7200	V _{PK}
V _{IOSM}	Maximum surge isolation voltage ⁽⁴⁾	V _{IOSM} ≥ 1.3 × V _{IMP} ; tested in oil (qualification test), 1.2/50-μs waveform per IEC 62368-1	10000	V _{PK}
q _{pd}	Apparent charge ⁽⁵⁾	Method a: After I/O safety test subgroup 2/3, V _{ini} = V _{IOTM} , t _{ini} = 60 s; V _{pd(m)} = 1.2 × V _{IORM} , t _m = 10 s	≤5	pC
		Method a: After environmental tests subgroup 1, V _{ini} = V _{IOTM} , t _{ini} = 60 s; V _{pd(m)} = 1.6 × V _{IORM} , t _m = 10 s	≤5	
		Method b: At routine test (100% production) and preconditioning (type test), V _{ini} = 1.2 × V _{IOTM} , t _{ini} = 1 s; V _{pd(m)} = 1.875 × V _{IORM} , t _m = 1 s (method b1) or V _{pd(m)} = V _{ini} , t _m = t _{ini} (method b3)	≤5	
C _{IO}	Barrier capacitance, input to output ⁽⁶⁾	V _{IO} = 0.4 × sin (2 πft), f = 1 MHz	1	pF
R _{IO}	Insulation resistance, input to output ⁽⁶⁾	V _{IO} = 500 V, T _A = 25°C	>10 ¹²	Ω
		V _{IO} = 500 V, 100°C ≤ T _A ≤ 125°C	>10 ¹¹	
		V _{IO} = 500 V at T _S = 150°C	>10 ⁹	
	Pollution degree		2	
	Climatic category		40/125/21	
UL 1577				
V _{ISO}	Withstand isolation voltage	V _{TEST} = V _{ISO} , t = 60 s (qualification); V _{TEST} = 1.2 × V _{ISO} , t = 1 s (100% production)	3750	V _{RMS}

- (1) Creepage and clearance requirements should be applied according to the specific equipment isolation standards of an application. Care must be taken during board design so that the mounting pads of the isolator on the printed-circuit board (PCB) do not reduce creepage and clearance. Inserting grooves, ribs or both can help increase creepage distance on the PCB.
- (2) This coupler is suitable for *safe electrical insulation* only within the safety ratings. Compliance with the safety ratings shall be ensured by means of suitable protective circuits.
- (3) Testing is carried out in air to determine the surge immunity of the package.
- (4) Testing is carried out in oil to determine the intrinsic surge immunity of the isolation barrier.
- (5) Apparent charge is electrical discharge caused by a partial discharge (pd).
- (6) All pins on each side of the barrier tied together creating a two-pin device.

7.7 Safety-Related Certifications

VDE	CSA	UL	CQC	TUV
Plan to certify according to DIN EN IEC 60747-17 (VDE 0884-17)	Plan to certify according to IEC 62368-1 and IEC 61010-1	Plan to certify according to UL 1577 Component Recognition Program	Plan to certify according to GB4943.1	Plan to certify according to EN 61010-1 and EN 62368-1
Certificate planned	Certificate planned	Certificate planned	Certificate planned	Certificate planned

7.8 Safety Limiting Values

Safety limiting⁽¹⁾ intends to minimize potential damage to the isolation barrier upon failure of input or output circuitry.

PARAMETER		TEST CONDITIONS	MIN	TYP	MAX	UNIT
SO5 PACKAGE						
I _S	Safety input, output, or supply current ⁽¹⁾	R _{θJA} = 215.9°C/W, V _I = 5.5 V, T _J = 135°C, T _A = 25°C			90	mA
		R _{θJA} = 215.9°C/W, V _I = 3.6 V, T _J = 135°C, T _A = 25°C			135	mA
		R _{θJA} = 215.9°C/W, V _I = 2.7 V, T _J = 135°C, T _A = 25°C			185	mA
		R _{θJA} = 215.9°C/W, V _I = 2 V, T _J = 135°C, T _A = 25°C			250	mA
P _S	Safety input, output, or total power ⁽¹⁾	R _{θJA} = 215.9°C/W, T _J = 135°C, T _A = 25°C			500	mW
T _S	Maximum safety temperature ⁽¹⁾				135	°C

- (1) The maximum safety temperature, T_S, has the same value as the maximum junction temperature, T_J, specified for the device. The I_S and P_S parameters represent the safety current and safety power respectively. The maximum limits of I_S and P_S should not be exceeded. These limits vary with the ambient temperature, T_A.

The junction-to-air thermal resistance, R_{θJA}, in the table is that of a device installed on a high-K test board for leaded surface-mount packages. Use these equations to calculate the value for each parameter:

T_J = T_A + R_{θJA} × P, where P is the power dissipated in the device.

T_{J(max)} = T_S = T_A + R_{θJA} × P_S, where T_{J(max)} is the maximum allowed junction temperature.

P_S = I_S × V_I, where V_I is the maximum input voltage.

7.9 Electrical Characteristics—DC

Over recommended operating conditions unless otherwise noted. All typical specifications are at $T_A = 25\text{ }^\circ\text{C}$ and $V_{CC} = 3.3\text{ V}$ unless otherwise noted.

PARAMETER		TEST CONDITIONS	MIN	TYP	MAX	UNIT
SUPPLY						
V_F	Input forward voltage	$I_F = 6\text{ mA}$	1.3	1.5	1.8	V
I_{CCH}	Logic HIGH output supply current	Figure 8-2 or Figure 8-3, $I_F = 0\text{ mA}$			2	mA
I_{CCL}	Logic LOW output supply current	Figure 8-2 or Figure 8-3, $I_F = 6\text{ mA}$			2	mA
I/O						
V_{OH}	Logic HIGH output voltage, ISOM8710	Figure 8-1, $I_F = 0, I_O = -4\text{ mA}, V_{CC} = 2.7\text{ V}$	$V_{CC} - 0.4$	$V_{CC} - 0.2$		V
		Figure 8-1, $I_F = 0, I_O = -4\text{ mA}, V_{CC} = 4.5\text{ V}$	$V_{CC} - 0.3$	$V_{CC} - 0.1$		V
V_{OL}	Logic LOW output voltage, ISOM8710	Figure 8-1, $I_F = 6\text{ mA}, I_O = 4\text{ mA}, V_{CC} = 2.7\text{ V}$		0.06	0.2	V
		Figure 8-1, $I_F = 6\text{ mA}, I_O = 4\text{ mA}, V_{CC} = 4.5\text{ V}$		0.04	0.2	V
	Logic LOW output voltage, ISOM8711	Figure 8-3, $I_F = 6\text{ mA}, V_{CC} = 4.5\text{ V}, R_L = 348\text{ }\Omega; I_{OL}(\text{sinking}) = 13\text{ mA}$		0.15	0.6	V
		Figure 8-3, $I_F = 6\text{ mA}, V_{CC} = 2.7\text{ V}, R_L = 208\text{ }\Omega; I_{OL}(\text{sinking}) = 13\text{ mA}$		0.22	0.6	V
I_{OH}	Logic HIGH output current, ISOM8711	Figure 8-3, $I_F = 0\text{ mA}, V_{OUT} = V_{CC} = 2.7\text{ V}$			100	μA
		Figure 8-3, $I_F = 0\text{ mA}, V_{OUT} = V_{CC} = 4.5\text{ V}$			100	μA
I_{TH}	Input threshold current		0.6	1	2	mA
I_{HYS}	Input current hysteresis			0.26		mA
I_R	Input reverse current	$V_R = 5\text{ V}, T_A = 25\text{ }^\circ\text{C}$			10	μA
C_i	Input capacitance	Anode to Cathode capacitance at $f = 1\text{ MHz}, V_F = 0\text{ V}$		4		pF

7.10 Switching Characteristics, ISOM8710

Over recommended operating conditions unless otherwise noted. $V_{CC} = 2.7\text{ V}$ to 5.5 V . All typical specifications are at $T_A = 25\text{ }^\circ\text{C}$ and $V_{CC} = 3.3\text{ V}$.

PARAMETER		TEST CONDITIONS	MIN	TYP	MAX	UNIT
t_r	Output signal rise time	Figure 8-2, $C_L = 15\text{ pF}$			10	ns
t_f	Output signal fall time	Figure 8-2, $C_L = 15\text{ pF}$			10	ns
t_{PLH}	Propagation delay time for output LOW to HIGH transition	Figure 8-2, $I_F = 6\text{ mA}$ to $0\text{ mA}, C_L = 15\text{ pF}, T_r = T_f = 5\text{ ns}$			52	ns
t_{PHL}	Propagation delay time for output HIGH to LOW transition	Figure 8-2, $I_F = 0\text{ mA}$ to $6\text{ mA}, C_L = 15\text{ pF}, T_r = T_f = 5\text{ ns}$			52	ns
PWD	Pulse Width Distortion $ t_{PHL} - t_{PLH} $	Figure 8-2, $I_F = 6\text{ mA}, C_L = 15\text{ pF}, T_r = T_f = 5\text{ ns}$		4.7	17	ns
t_{psk}	Part-to-part delay skew	$I_F = 6\text{ mA}, C_L = 15\text{ pF}, T_r = T_f = 5\text{ ns}$			15	ns
$ CMTI_L $	Common mode transient immunity with a static LOW output	Figure 8-5, $V_{CM} = 1200\text{ V}_{p-p}, I_F = 6\text{ mA}, \text{output} = \text{LOW}$	± 125	± 150		kV/ μs
$ CMTI_H $	Common mode transient immunity with a static HIGH output	Figure 8-5, $V_{CM} = 1200\text{ V}_{p-p}, I_F = 0\text{ mA}, \text{output} = \text{HIGH}$	± 800	± 1000		kV/ μs
TIE	Time Interval Error	$2^{16} - 1$ PRBS data at $20\text{ Mbps}, I_F = 6\text{ mA}$		4.2	12	ns

7.11 Switching Characteristics, ISOM8711

Over recommended operating conditions unless otherwise noted. $V_{CC} = 2.7\text{ V}$ to 5.5 V . $R_L = 300\text{ }\Omega$ unless otherwise specified. All typical specifications are at $T_A = 25\text{ }^\circ\text{C}$ and $V_{CC} = 3.3\text{ V}$.

PARAMETER		TEST CONDITIONS	MIN	TYP	MAX	UNIT
t_r	Output signal rise time	Figure 8-3, $R_L = 300\text{ }\Omega, C_L = 15\text{ pF}$			15	ns
t_f	Output signal fall time	Figure 8-3, $R_L = 300\text{ }\Omega, C_L = 15\text{ pF}$			15	ns

ISOM8710, ISOM8711

SLLSFO4C – DECEMBER 2022 – REVISED SEPTEMBER 2023

Over recommended operating conditions unless otherwise noted. $V_{CC} = 2.7\text{ V to }5.5\text{ V}$. $R_L = 300\ \Omega$ unless otherwise specified. All typical specifications are at $T_A = 25\ ^\circ\text{C}$ and $V_{CC} = 3.3\text{ V}$.

PARAMETER		TEST CONDITIONS	MIN	TYP	MAX	UNIT
t_{PLH}	Propagation delay time for output LOW to HIGH transition	Figure 8-3, $I_F = 6\text{ mA to }0\text{ mA}$, $C_L = 15\text{ pF}$. $T_r = T_f = 5\text{ ns}$, $R_L = 300\ \Omega$			54	ns
t_{PHL}	Propagation delay time for output HIGH to LOW transition	Figure 8-3, $I_F = 0\text{ mA to }6\text{ mA}$, $C_L = 15\text{ pF}$. $T_r = T_f = 5\text{ ns}$, $R_L = 300\ \Omega$			54	ns
PWD	Pulse Width Distortion $ t_{PHL} - t_{PLH} $	Figure 8-3, $I_F = 6\text{ mA}$, $C_L = 15\text{ pF}$. $T_r = T_f = 5\text{ ns}$		4.8	26	ns
t_{psk}	Part-to-part delay skew	$I_F = 6\text{ mA}$, $C_L = 15\text{ pF}$. $T_r = T_f = 5\text{ ns}$			15	ns
$ CMTI_L $	Common mode transient immunity with a static LOW output	Figure 8-6, $V_{CM} = 1200\text{ V}_{p-p}$, $I_F = 6\text{ mA}$, Output = LOW	± 125	± 150		kV/ μs
$ CMTI_H $	Common mode transient immunity with a static HIGH output	Figure 8-6, $V_{CM} = 1200\text{ V}_{p-p}$, $I_F = 0\text{ mA}$, Output = HIGH	± 800	± 1000		kV/ μs
TIE	Time Interval Error	$2^{16} - 1$ PRBS data at 20 Mbps, $I_F = 6\text{ mA}$		3.7	12	ns

7.12 Typical Characteristics

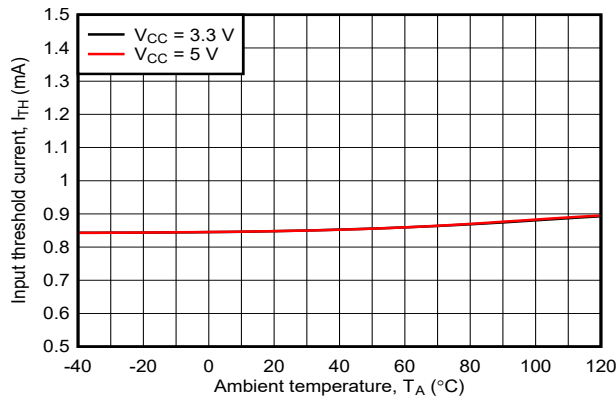

ISOM871x

Figure 7-1. Input Threshold Current vs Ambient Temperature

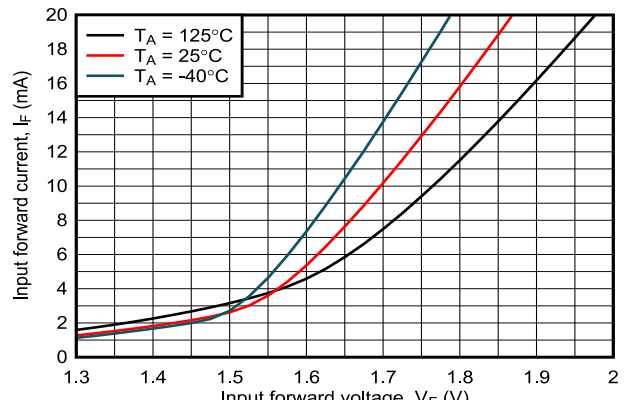

ISOM871x

Figure 7-2. Input Forward Current vs Input Forward Voltage

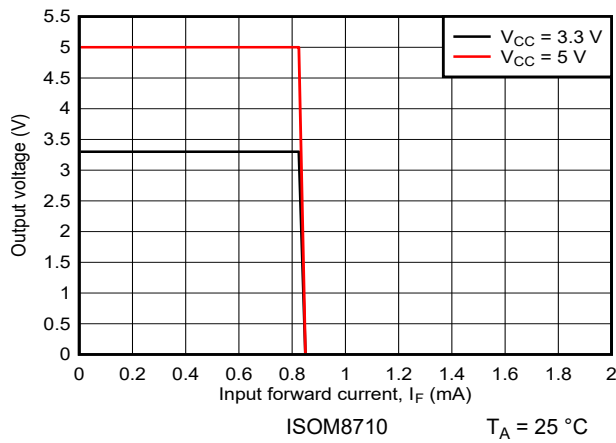

ISOM8710 $T_A = 25^\circ\text{C}$

Figure 7-3. Output Voltage vs Input Forward Current

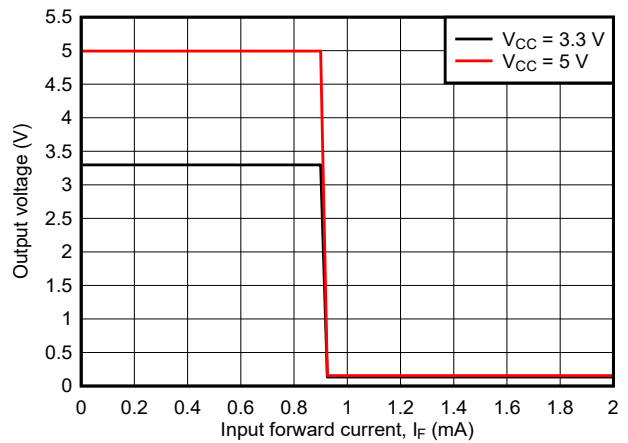

ISOM8711 $T_A = 25^\circ\text{C}$

Figure 7-4. Output Voltage vs Input Forward Current

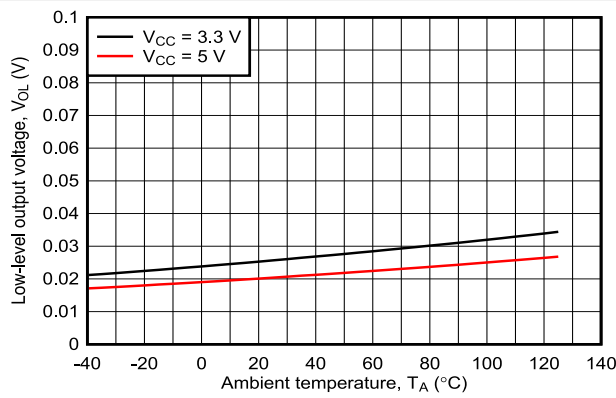

$I_F = 6\text{ mA}$ ISOM8710 $I_{OL} = 2\text{ mA}$

Figure 7-5. Low-Level Output Voltage vs Ambient Temperature

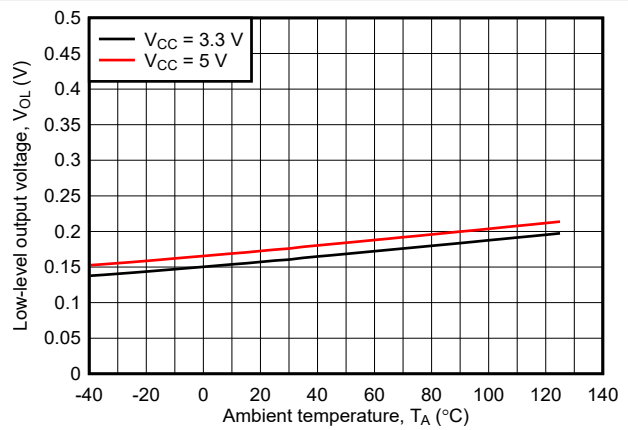

$I_F = 6\text{ mA}$ ISOM8711 $I_{OL} = 2\text{ mA}$

Figure 7-6. Low-Level Output Voltage vs Ambient Temperature

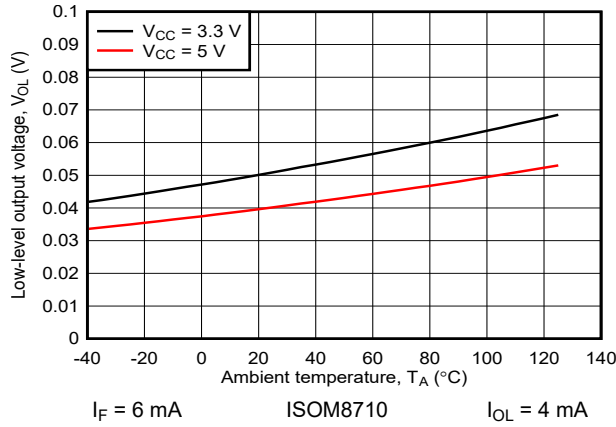

Figure 7-7. Low-Level Output Voltage vs Ambient Temperature

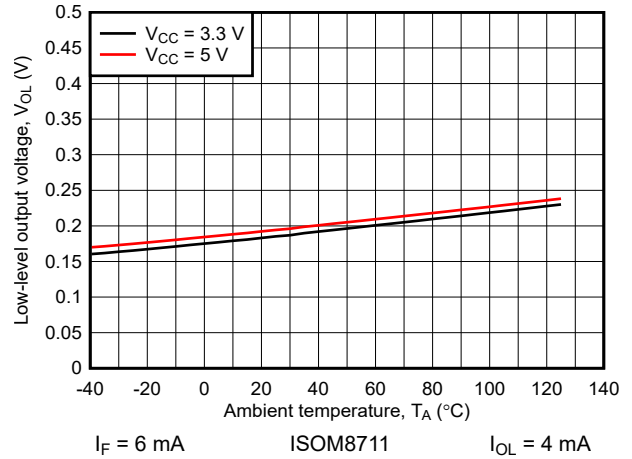

Figure 7-8. Low-Level Output Voltage vs Ambient Temperature

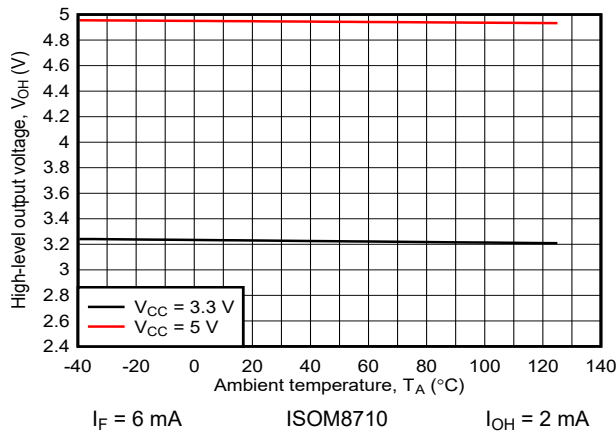

Figure 7-9. High-Level Output Voltage vs Ambient Temperature

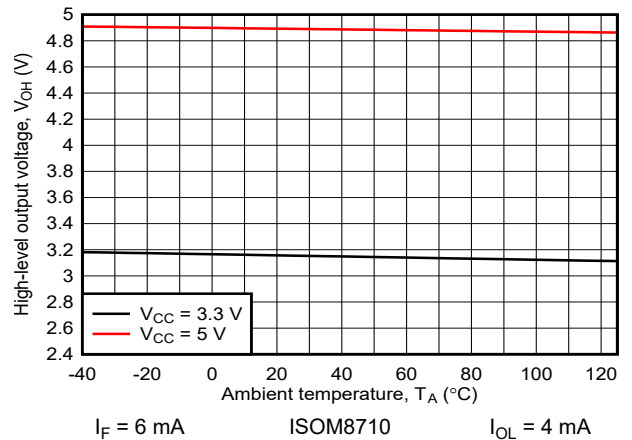

Figure 7-10. High-Level Output Voltage vs Ambient Temperature

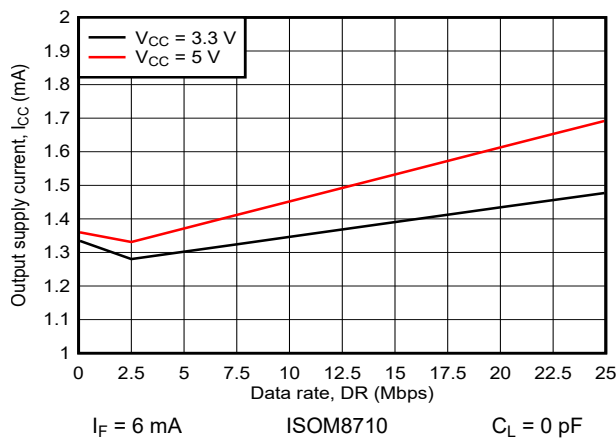

Figure 7-11. Output Supply Current vs Data Rate

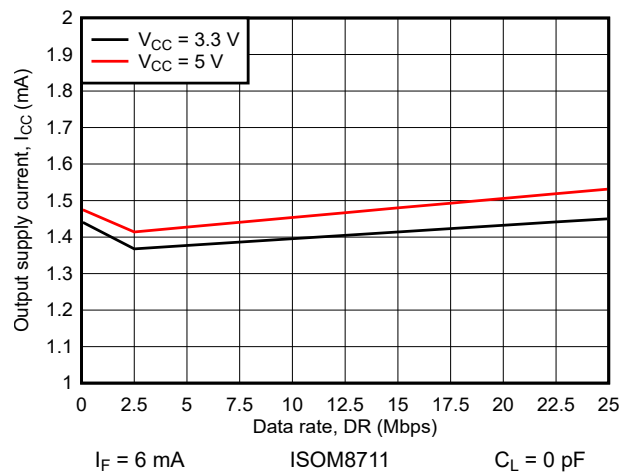

Figure 7-12. Output Supply Current vs Data Rate

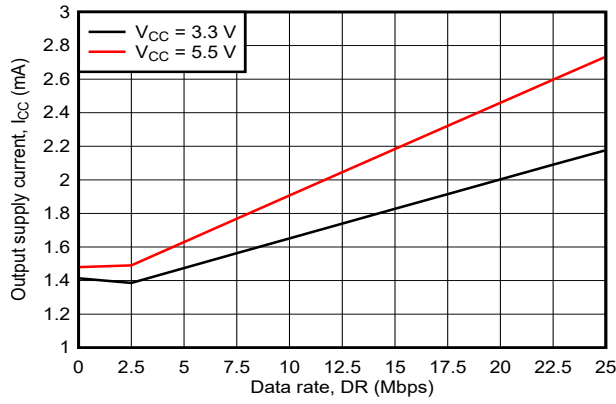

Figure 7-13. Output Supply Current vs Data Rate

$I_F = 6 \text{ mA}$ ISOM8710 $C_L = 15 \text{ pF}$

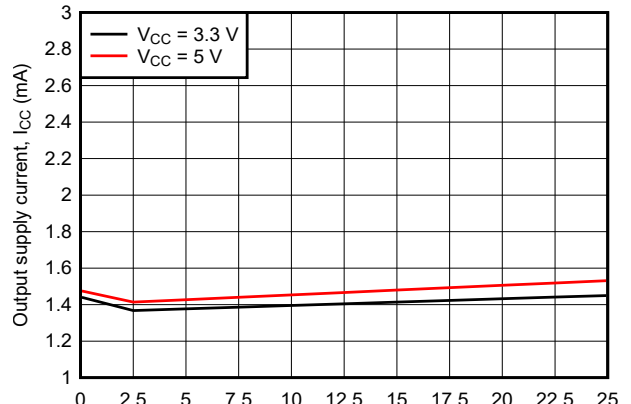

Figure 7-14. Output Supply Current vs Data Rate

$I_F = 6 \text{ mA}$ ISOM8711 $C_L = 15 \text{ pF}$

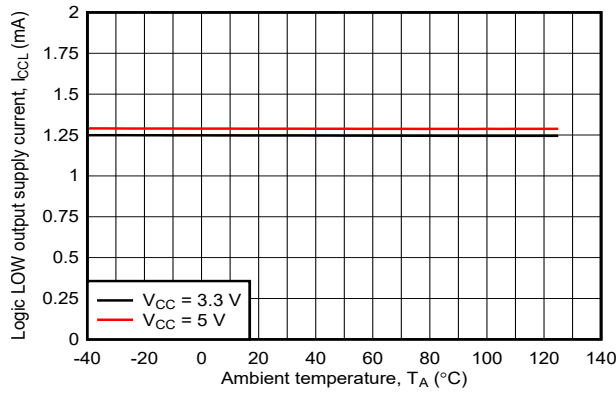

Figure 7-15. Logic LOW Output Supply Current vs Ambient Temperature

$I_F = 6 \text{ mA}$ ISOM8710

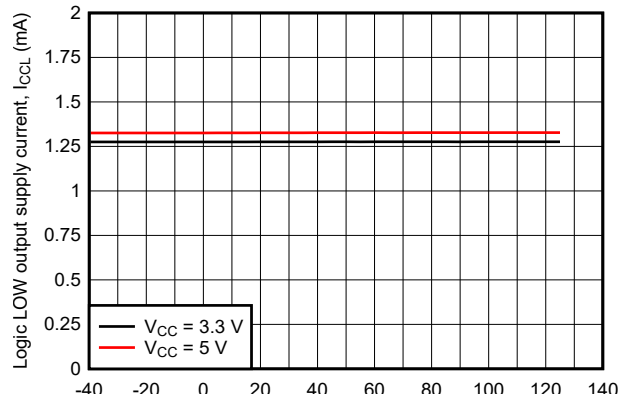

Figure 7-16. Logic LOW Output Supply Current vs Ambient Temperature

$I_F = 6 \text{ mA}$ ISOM8711

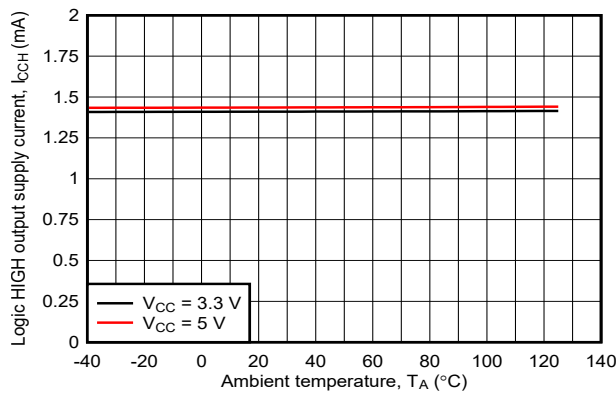

Figure 7-17. Logic HIGH Output Supply Current vs Ambient Temperature

$I_F = 0 \text{ mA}$ ISOM8710

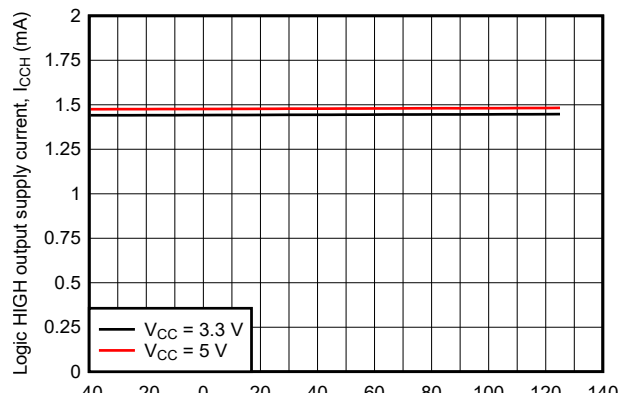

Figure 7-18. Logic HIGH Output Supply Current vs Ambient Temperature

$I_F = 0 \text{ mA}$ ISOM8711

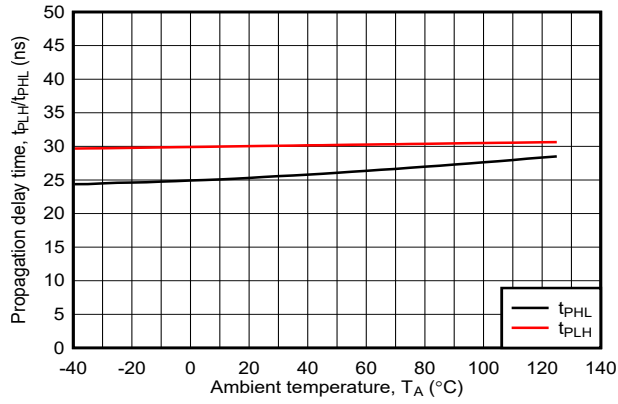

Figure 7-19. Propagation Delay Time vs Ambient Temperature

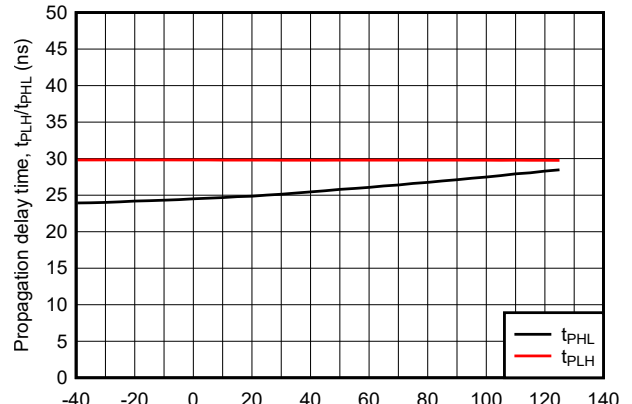

Figure 7-20. Propagation Delay Time vs Ambient Temperature

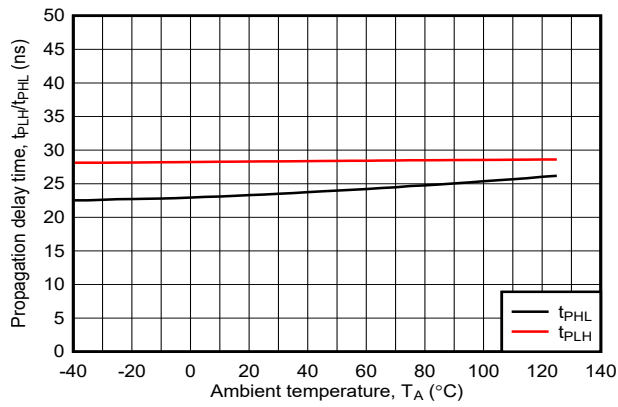

Figure 7-21. Propagation Delay Time vs Ambient Temperature

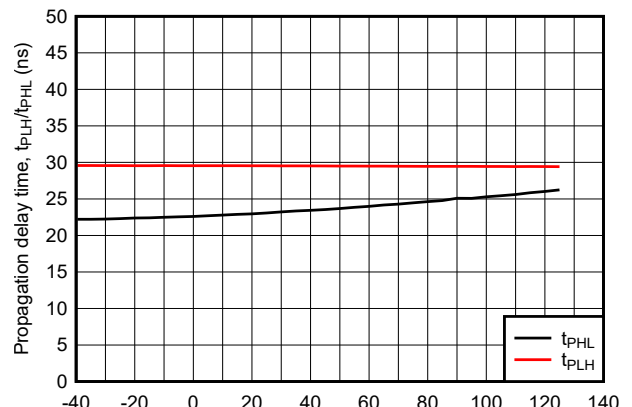

Figure 7-22. Propagation Delay Time vs Ambient Temperature

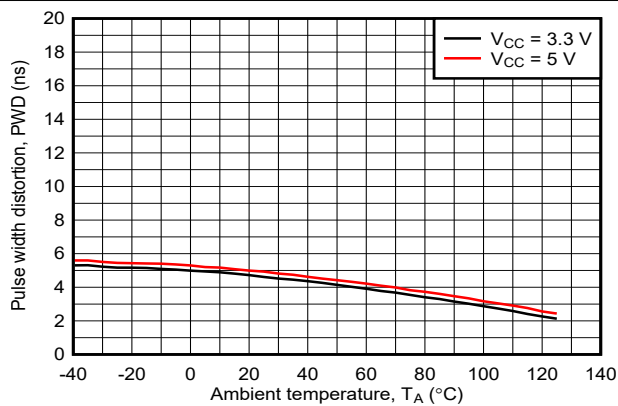

Figure 7-23. Pulse Width Distortion vs Ambient Temperature

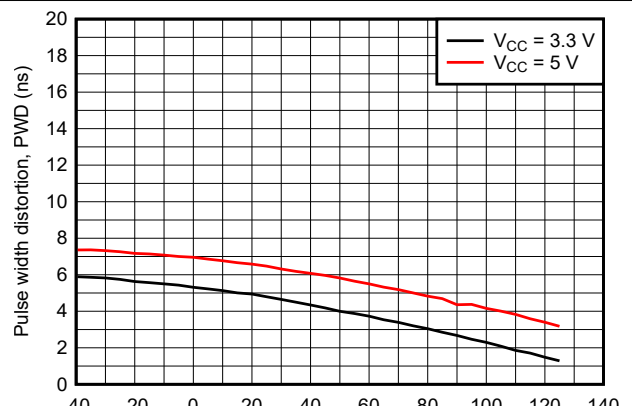
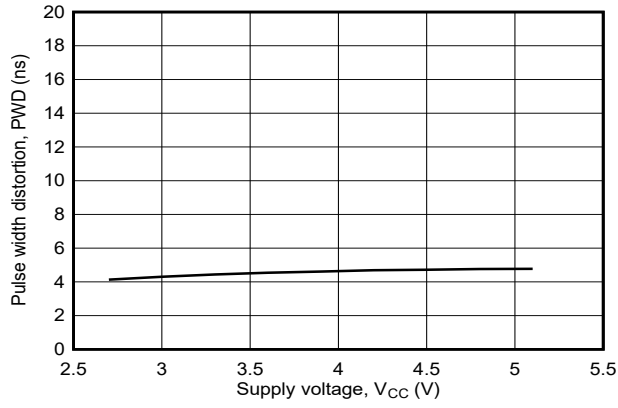
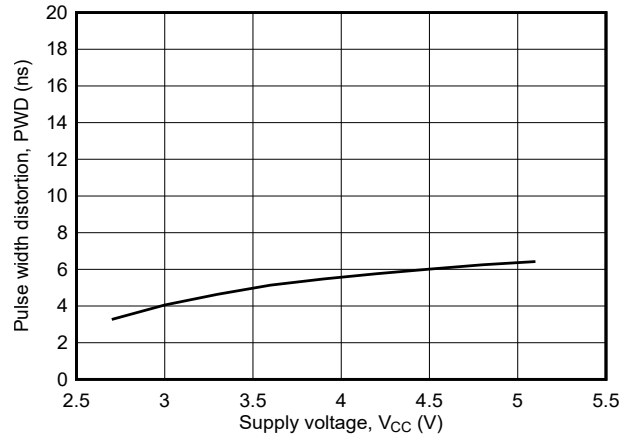

Figure 7-24. Pulse Width Distortion vs Ambient Temperature



$I_F = 6 \text{ mA}$ ISOM8710 $C_L = 15 \text{ pF}$

Figure 7-25. Pulse Width Distortion vs Supply Voltage



$I_F = 6 \text{ mA}$ ISOM8711 $C_L = 15 \text{ pF}$

Figure 7-26. Pulse Width Distortion vs Supply Voltage

8 Parameter Measurement Information

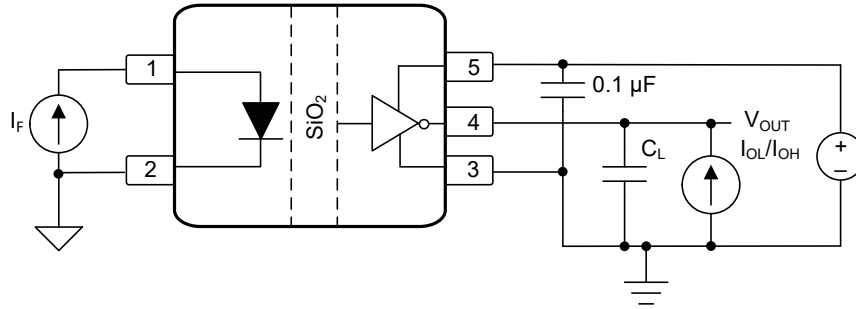

Figure 8-1. ISOM8710 Current-Source Test Circuit for V_{OL} and V_{OH}

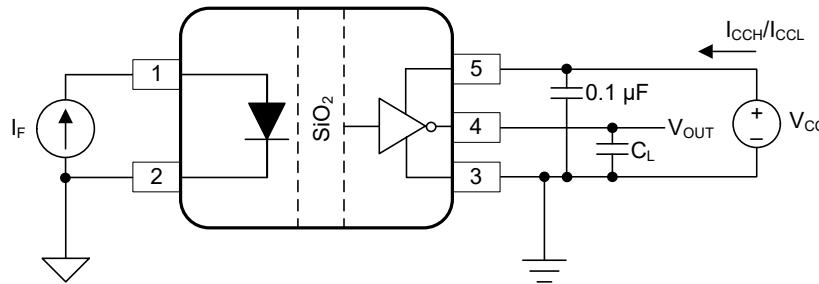

Figure 8-2. ISOM8710 Current-Source Test Circuit for I_{CCL} , I_{CCH} , and Switching Timing

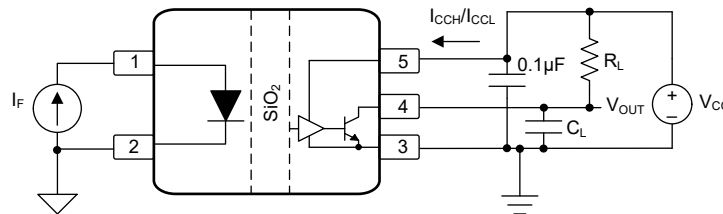

Figure 8-3. ISOM8711 Current-Source Test Circuit for Electrical and Switching Timing

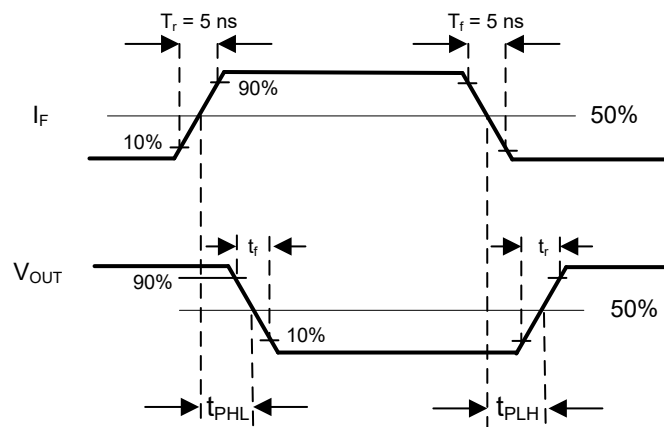

Figure 8-4. Switching Timing Waveforms

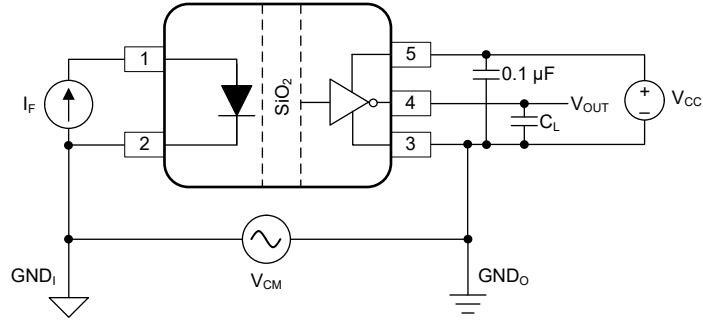

Figure 8-5. ISOM8710 Test Circuit for Common-Mode Transient Immunity

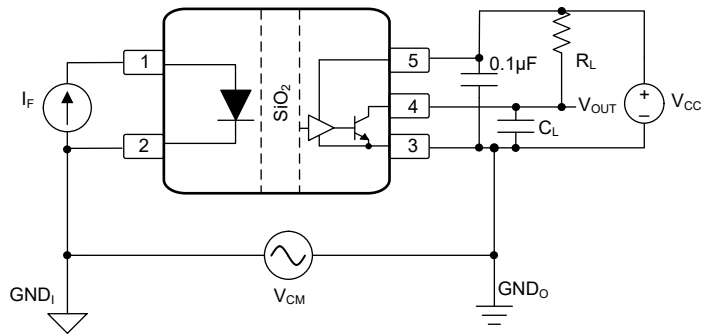

Figure 8-6. ISOM8711 Test Circuit for Common-Mode Transient Immunity

9 Detailed Description

9.1 Overview

The ISOM871x family of devices are opto-emulators that provide isolation for digital signals of data rates up to 25 Mbps and are single-channel, pin-compatible, drop-in replacements for optocouplers. While standard optocouplers use an LED as the input stage, ISOM871x uses an emulated diode as the input stage. The input stage is isolated from the driver stage by TI's proprietary silicon dioxide-based (SiO_2) isolation barrier, which not only provides robust isolation, but also offers best-in-class common mode transient immunity. Ordering options include CMOS output and open collector output options.

ISOM871x devices isolate high speed digital signals and offer performance, reliability, and flexibility advantages not available with traditional optocouplers. The devices are based on CMOS isolation technology for low-power and high-speed operation, therefore they are resistant to the wear-out effects found in optocouplers that degrade performance with increasing temperature, forward current, and device age.

The functional block diagram of ISOM871x devices is shown in [Section 9.2](#). The input signal is transmitted across the isolation barrier using an on-off keying (OOK) modulation scheme. The transmitter sends a high-frequency carrier across the barrier to represent one digital state and sends no signal to represent the other digital state. The receiver demodulates the signal after advanced signal conditioning and produces the signal through the output stage. These devices also incorporate advanced circuit techniques to maximize CMTI performance and minimize radiated emissions. [Figure 9-2](#) shows conceptual detail of how the OOK scheme works.

9.2 Functional Block Diagram

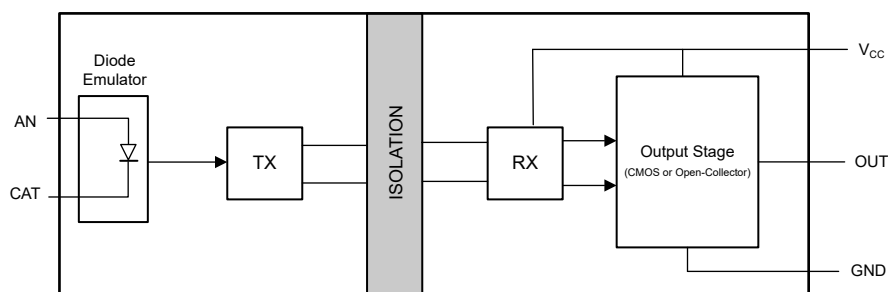

Figure 9-1. Conceptual Block Diagram of an Opto-emulator

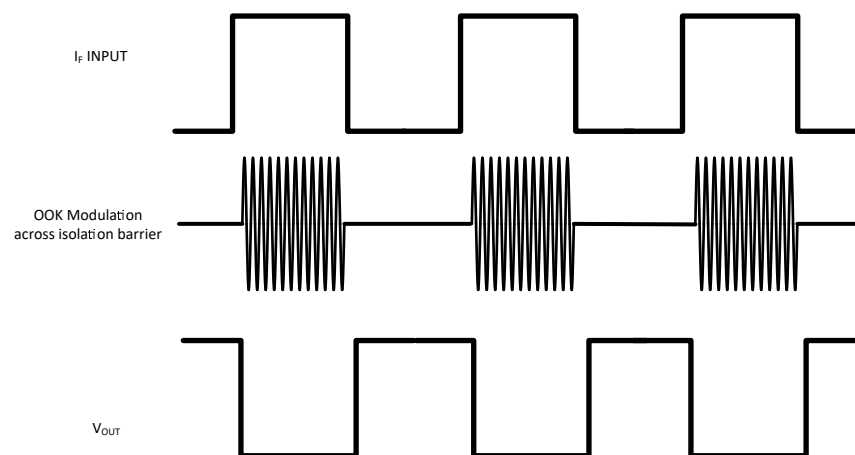

Figure 9-2. On-off Keying (OOK) Based Modulation Scheme

9.3 Feature Description

The ISOM871x devices receive current input and provide isolated voltage outputs. ISOM8710 has an output buffer on the receiver side which is capable of providing enough current to drive most logic-input devices. ISOM8711 has an open-collector output driven by an output buffer. Both devices are capable of isolating signals of up to 25 Mbps datarates and have an isolation voltage rating of 3750 V_{RMS} between side 1 and side 2.

9.4 Device Functional Modes

Table 9-1 lists the functional modes for the ISOM871x devices.

Table 9-1. Function Table

V _{CC} STATE ⁽²⁾	INPUT CURRENT I _F ⁽¹⁾	OUTPUT	COMMENTS
PU	> I _{TH}	L	Channel output assumes the inverse logic state of channel input.
	< I _{TH}	H	
PD	X	Undetermined	When V _{CC} is unpowered, the output is undetermined ⁽²⁾ . When V _{CC} transitions from unpowered to powered up, the channel output assumes the corresponding logic state based on the logic state of the input.

- (1) V_{CC} = Output power supply; PU = Powered up (V_{CC} ≥ 2.7 V); PD = Powered down (V_{CC} ≤ 2 V); X = Irrelevant; H = High level; L = Low level
 (2) The outputs are in an undetermined state when 2 V < V_{CC} < 2.7 V.

10 Application and Implementation

Note

Information in the following applications sections is not part of the TI component specification, and TI does not warrant its accuracy or completeness. TI's customers are responsible for determining suitability of components for their purposes. Customers should validate and test their design implementation to confirm system functionality.

10.1 Application Information

The ISOM871x devices are single-channel opto-emulators with diode-emulator inputs and digital outputs. The devices use on-off keying modulation to transmit data across the isolation barrier. Since an isolation barrier separates the two sides of these devices, each side can be sourced independently with voltages and currents within recommended operating conditions. As an example, it is possible to supply the ISOM871x V_{CC} pin with 3.3 V (which is within the 2.7-V to 5.5-V range for V_{CC}) and drive the diode-emulator input with 5 mA (which is also within the 2-mA to 20-mA range for I_F).

The opto-emulator may also be used as a current-to-voltage translator or voltage level-translator in addition to providing isolation. Opto-emulators do not conform to any specific interface standard and are intended for isolating single-ended digital signal lines. Isolation devices like ISOM871x are typically placed between a data controller (that is, an MCU or FPGA), and a sensor, data converter, or a line transceiver, regardless of the interface type or standard.

10.2 Typical Application

For industrial applications, the ISOM871x devices can be used with a Texas Instruments mixed signal microcontroller, digital-to-analog converter, transformer driver, CAN transceiver, buffer, and voltage regulator to create an isolated CAN communication system. The different components of this typical schematic, like the microcontroller, transceiver, optional buffer, and power supply, can be replaced to create isolated RS-485, UART, SPI, GPIO, and other isolated signal communication systems. Additionally, ISOM871x devices can be used to isolate other signals within its *Recommended Operating Conditions*, including PWM power supply feedback signals.

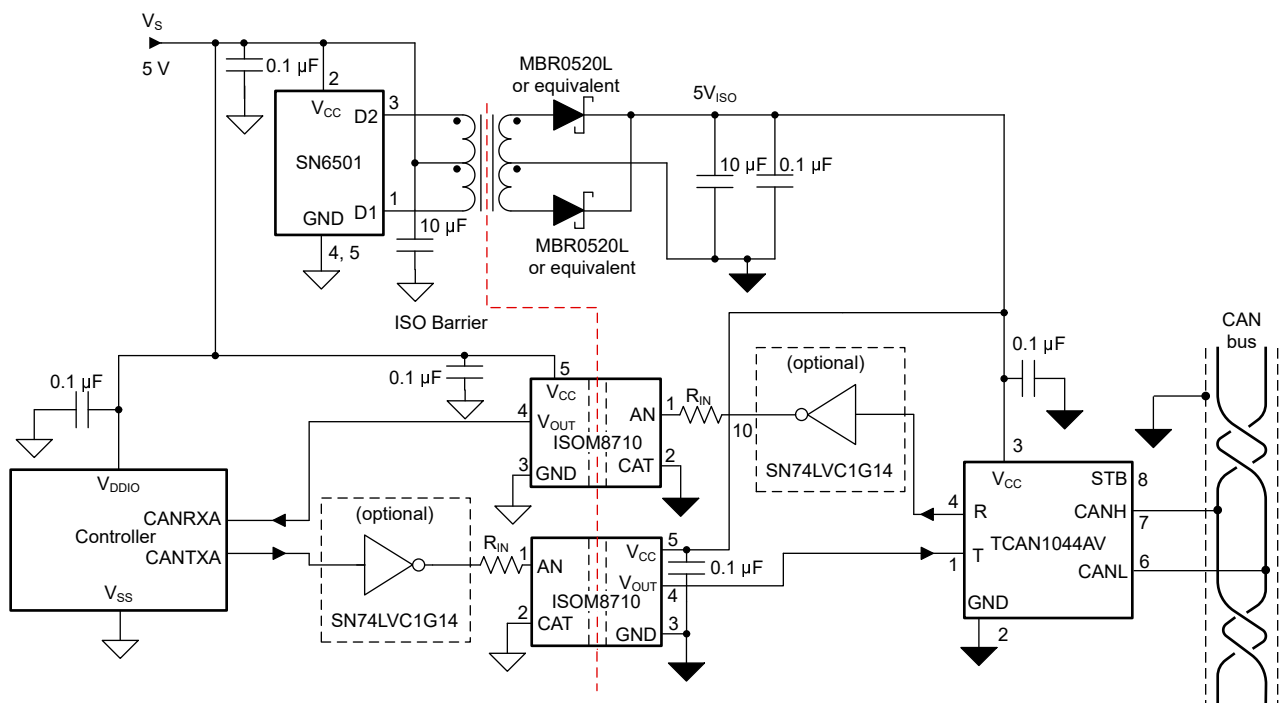

Figure 10-1. Typical Isolated CAN Application Using ISOM8710

10.2.1 Design Requirements

To design with ISOM871x devices, use the parameters listed in [Table 10-1](#).

Table 10-1. Design Parameters

PARAMETER	VALUE	EXAMPLE VALUE
Supply voltage, V_{CC}	2.7 V to 5.5V	3.3 V or 5 V
Input forward current, I_F , for up to 5-Mbps data rates	2 mA to 20 mA	2 mA
Input forward current, I_F , for up to 10-Mbps data rates	3 mA to 20 mA	5 mA
Input forward current, I_F , for up to 25-Mbps data rates	6 mA to 20 mA	10 mA
Decoupling capacitor between V_{CC} and GND	0.1 μ F	0.1 μ F
Pull-up resistor value, R_L , between OUT and V_{CC} for ISOM8711	750 Ω to 50 k Ω	4.7 k Ω

10.2.2 Detailed Design Procedure

This section presents the design procedure for using the ISOM871x opto-emulators. External components should be selected to operate ISOM871x within the [Recommended Operating Conditions](#). The following recommendations on components selection focus on the design of a typical isolated signal circuit with considerations for input current and data rate.

10.2.2.1 Sizing R_{IN}

The input side of ISOM871x is current-driven. To limit the amount of current flowing into the AN pin, it is recommended that a series resistor, R_{IN} , is used in series with the input as shown in [Figure 10-1](#).

R_{IN} can be sized to minimize current flow and power consumption through the ISOM871x input-side, or it can be sized to enable higher data rates, depending on the application requirements. Regardless of the requirements, R_{IN} should be a value that will limit the input forward current to be within the [Recommended Operating Conditions](#) for ISOM871x. The equation to calculate R_{IN} for a given input voltage, V_{IN} , and desired input forward current, I_F , is shown in [Equation 1](#) where V_F is the maximum spec for the ISOM871x input forward voltage:

$$R_{IN} = \frac{V_{IN} - V_F [MAX]}{I_F} \quad (1)$$

For example, with a 24-V input and 10-mA desired I_F , R_{IN} can be calculated as:

$$R_{IN} = \frac{24\text{ V} - 1.8\text{ V}}{10\text{ mA}} = 2.22\text{ k}\Omega \quad (2)$$

10.2.2.2 Driving the Input with a Buffer

The input of ISOM871x can be driven by an inverting buffer or non-inverting buffer to change the truth table of the ISOM871x or provide sufficient input forward current to drive the device. Using a buffer is optional. If a buffer is used, the equation for R_{IN} remains the same as shown above.

Sizing R_{IN} based on the output voltage of the buffer, V_{BUF} , and the desired forward input current, I_F , [Equation 1](#) becomes:

$$R_{IN} = \frac{V_{BUF} - V_F [MAX]}{I_F} \quad (3)$$

For example, using a buffer with a 5-V output, and a desired I_F of 5-mA, R_{IN} is calculated as:

$$R_{IN} = \frac{5\text{ V} - 1.8\text{ V}}{5\text{ mA}} = 640\ \Omega \quad (4)$$

10.2.2.3 Calculating R_L for ISOM8711

An R_L component is not necessary if using ISOM8710. Since ISOM8711 features an open-collector OUT pin, a pull-up resistor, R_L , connecting OUT to V_{CC} is necessary for transmission of logic-HIGH signals. This pull-up resistor pulls the line HIGH when the line is not driven LOW by the open-collector OUT pin. The value of R_L is an important design consideration for systems using ISOM8711 since a value that is too low (strong pull-up) can result in excessive power dissipation while a value that is too high (weak pull-up) can lead to signal loss at high frequencies. Below are equations for the pullup resistor calculation.

Step 1: Calculate the Minimum R_L

An R_L value that is too small can prevent the OUT pin of the ISOM8711 from being able to drive LOW signals. Thus, the equation for minimum R_L is a function of V_{CC} , the maximum voltage level that can be read as a LOW signal by the input buffers of the connected device, V_{IL} , and the maximum current OUT can sink in LOW signal states, I_{OS} , as shown in [Equation 5](#).

$$R_L [\text{MIN}] = \frac{V_{CC} - V_{IL} [\text{MAX}]}{I_{OS} [\text{MAX}]} \quad (5)$$

Most CMOS-input devices have maximum V_{IL} thresholds as a function of the supply, like 30% the V_{CC} level, while TTL-input devices can have a fixed V_{IL} threshold regardless of the supply, like 0.8 V.

For an example $V_{CC} = 3.3$ V, a maximum V_{IL} of 0.99 V, and maximum I_{OS} of 13 mA, minimum R_L is calculated as:

$$R_L [\text{MIN}] = \frac{3.3 \text{ V} - 0.99 \text{ V}}{13 \text{ mA}} = 178 \ \Omega \quad (6)$$

Step 2: Calculate the Maximum R_L

The maximum pullup resistance is limited by the load and trace capacitance, C_L , of the OUT signal line due to standard rise time specifications. If the pullup resistor value is too high, the signal line cannot rise to a logical HIGH before being pulled LOW again. Thus, to calculate the maximum appropriate R_L value, the maximum allowable rise time, t_R , must first be calculated using [Equation 7](#) and the maximum allowable rise time as a percentage of the data rate period and the maximum data rate of the signal to be transmitted.

$$t_R = 2 \times \frac{\text{rise time \%}}{\text{data rate} [\text{MAX}]} \quad (7)$$

This rise time can be set equal to the time constant factor needed for a 10% to 90% transition to occur and solved for the resistor value, as shown in [Equation 8](#):

$$R_L [\text{MAX}] = \frac{t_R}{2.2 \times C_L} \quad (8)$$

For example, if rise time can occupy 15% of the period for a 10-Mbps signal, rise time in seconds is calculated as:

$$t_R = 2 \times \frac{15 \%}{10 \text{ Mbps}} = 30 \text{ ns} \quad (9)$$

With a 30-ns rise-time and a typical load capacitance of 2 pF, maximum R_L is estimated as:

$$R_L [\text{MAX}] = \frac{30 \text{ ns}}{2.2 \times 2 \text{ pF}} = 6.82 \text{ k}\Omega \quad (10)$$

Step 3: Select R_L to be Between R_L (min) and R_L (max)

The selected R_L value should be between the calculated R_L [min] and R_L [max] values to meet the design criteria. A lower value will enable faster signal transmission or higher load and trace capacitances while a higher value will consume lower power.

10.2.3 Application Curves

The following typical switching curve shows data transmission using the ISOM871x.

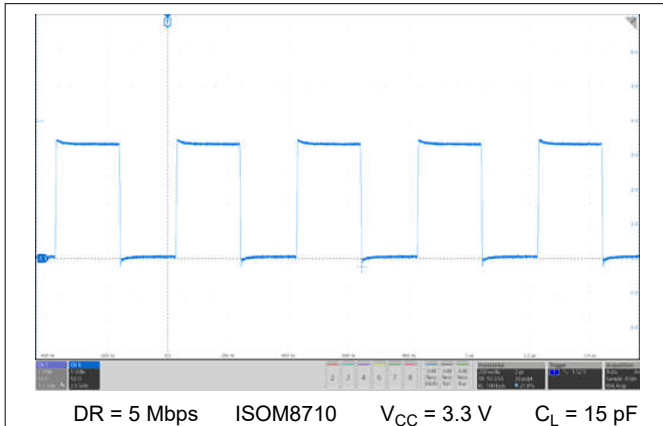

Figure 10-2. Typical Output Waveform at $I_F = 2$ mA

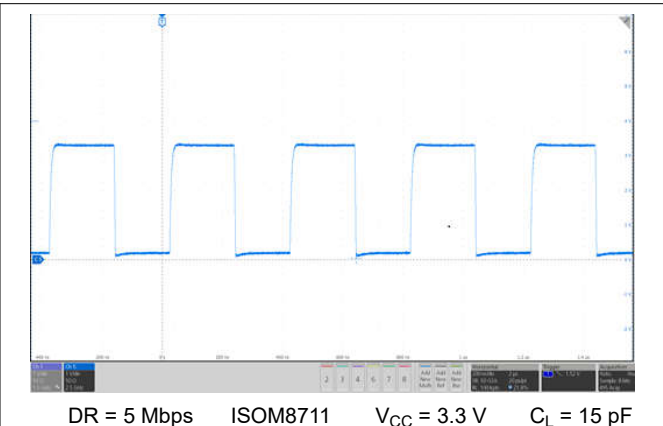

Figure 10-3. Typical Output Waveform at $I_F = 2$ mA

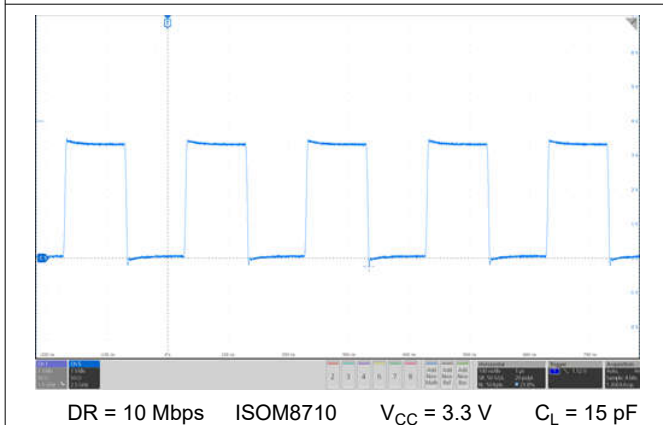

Figure 10-4. Typical Output Waveform at $I_F = 3$ mA

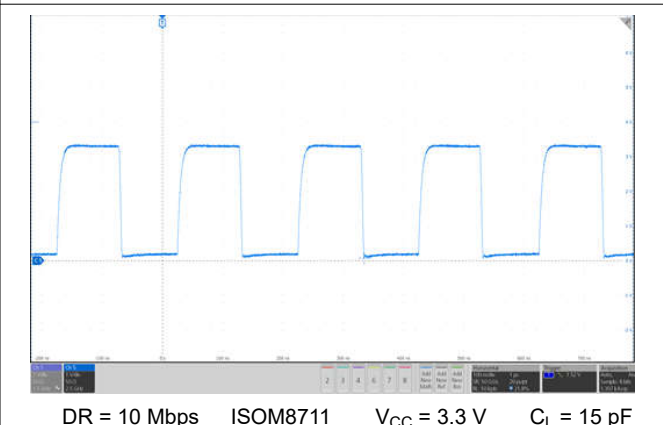

Figure 10-5. Typical Output Waveform at $I_F = 3$ mA

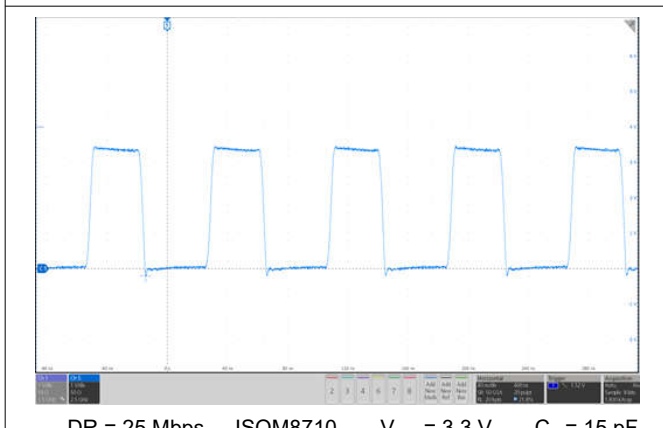

Figure 10-6. Typical Output Waveform at $I_F = 6$ mA

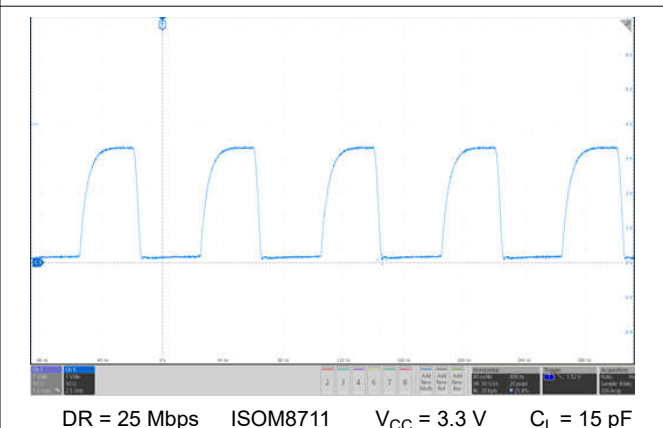

Figure 10-7. Typical Output Waveform at $I_F = 6$ mA

10.3 Power Supply Recommendations

The device is designed to operate from an input voltage supply range between 2.7 V and 5.5 V. To help facilitate reliable operation at data rates and supply voltages, a 0.1- μ F bypass capacitor is recommended on the V_{CC} power supply pin. Place the capacitor within 2 mm of the V_{CC} pin and as close to the V_{CC} pin as possible.

If only a single primary-side power supply is available in an application, isolated power can be generated for the secondary-side with the help of an isolation transformer driver, such as Texas Instruments' SN6501, SN6505A/B, or SN6507. For such applications, detailed power supply design and transformer selection recommendations are available in the data sheets for each of these products and their respective product webpages on TI.com.

10.4 Layout

10.4.1 Layout Guidelines

- Bypass the V_{CC} pin to ground with a low-ESR ceramic bypass capacitor. The typical recommended bypass capacitance is 0.1 μ F when using a ceramic capacitor with an X5R- or X7R-rated dielectric. The capacitor should be placed as close to the V_{CC} pin as possible in the PCB layout and on the same layer. The capacitor must have a voltage rating greater than the V_{CC} voltage level.
- The device connections to ground should be tied to the PCB ground plane using a direct connection or two vias to help minimize inductance.
- The connections of capacitors and other components to the PCB ground plane should use a direct connection or two vias for minimum inductance.

10.4.2 Layout Example

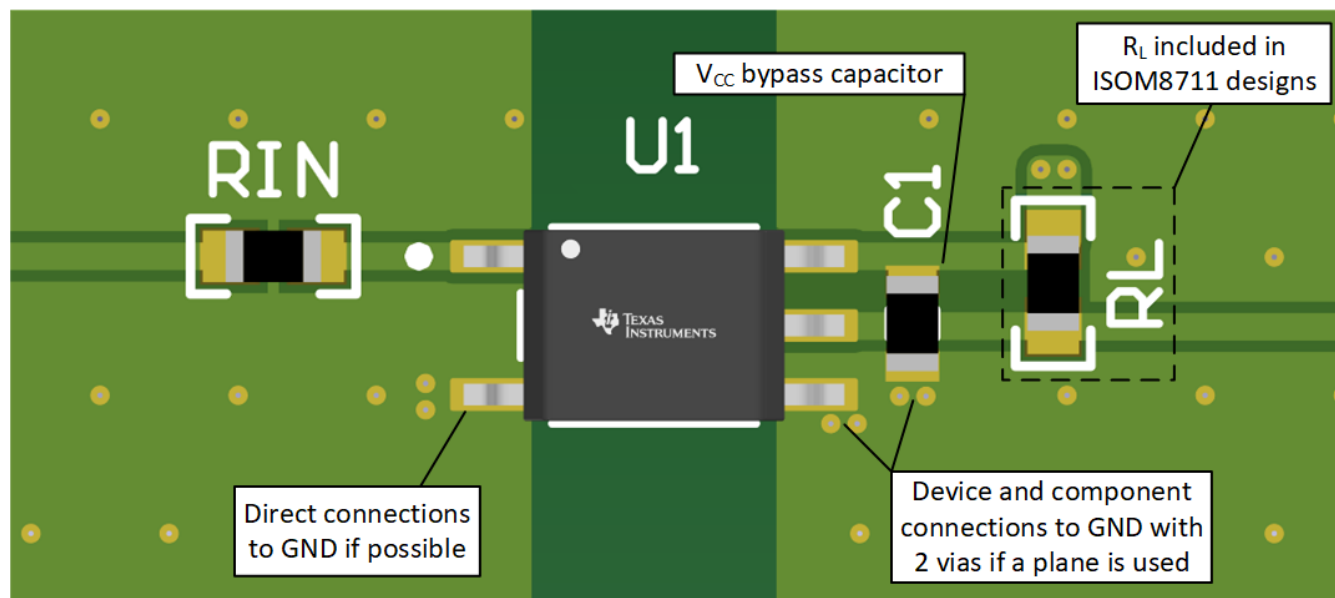

Figure 10-8. Layout Example of ISOM871x with a 2-Layer Board

11 Device and Documentation Support

11.1 Documentation Support

For related documentation see the following:

- Texas Instruments, [Isolation Glossary](#)
- Texas Instruments, [Introduction to Opto-Emulators application note](#)
- Texas Instruments, [ISOM8710 High-Speed Single-Channel Opto-Emulator Evaluation Module user's guide](#)
- Texas Instruments, [SN6501 Transformer Driver for Isolated Power Supplies data sheet](#)
- Texas Instruments, [SN6505x Low-Noise 1-A Transformer Drivers for Isolated Power Supplies data sheet](#)
- Texas Instruments, [SN6507 Low-Emissions, 36-V Push-Pull Transformer Driver with Duty Cycle Control for Isolated Power Supplies data sheet](#)
- Texas Instruments, [TCAN1044A-Q1 and TCAN1044AV-Q1 Automotive Fault-Protected CAN FD Transceiver with Standby mode data sheet](#)

11.2 Receiving Notification of Documentation Updates

To receive notification of documentation updates, navigate to the device product folder on [ti.com](#). Click on *Subscribe to updates* to register and receive a weekly digest of any product information that has changed. For change details, review the revision history included in any revised document.

11.3 Support Resources

[TI E2E™ support forums](#) are an engineer's go-to source for fast, verified answers and design help — straight from the experts. Search existing answers or ask your own question to get the quick design help you need. Linked content is provided "AS IS" by the respective contributors. They do not constitute TI specifications and do not necessarily reflect TI's views; see TI's [Terms of Use](#).

11.4 Trademarks

All trademarks are the property of their respective owners.

11.5 Electrostatic Discharge Caution



This integrated circuit can be damaged by ESD. Texas Instruments recommends that all integrated circuits be handled with appropriate precautions. Failure to observe proper handling and installation procedures can cause damage.

ESD damage can range from subtle performance degradation to complete device failure. Precision integrated circuits may be more susceptible to damage because very small parametric changes could cause the device not to meet its published specifications.

11.6 Glossary

[TI Glossary](#) This glossary lists and explains terms, acronyms, and definitions.

12 Mechanical, Packaging, and Orderable Information

The following pages include mechanical packaging and orderable information. This information is the most current data available for the designated devices. This data is subject to change without notice and revision of this document. For browser-based versions of this data sheet, refer to the left-hand navigation.

PACKAGE OUTLINE

DFF0005A-C01

SOIC - 2.65 mm max height

SMALL OUTLINE INTEGRATED CIRCUIT

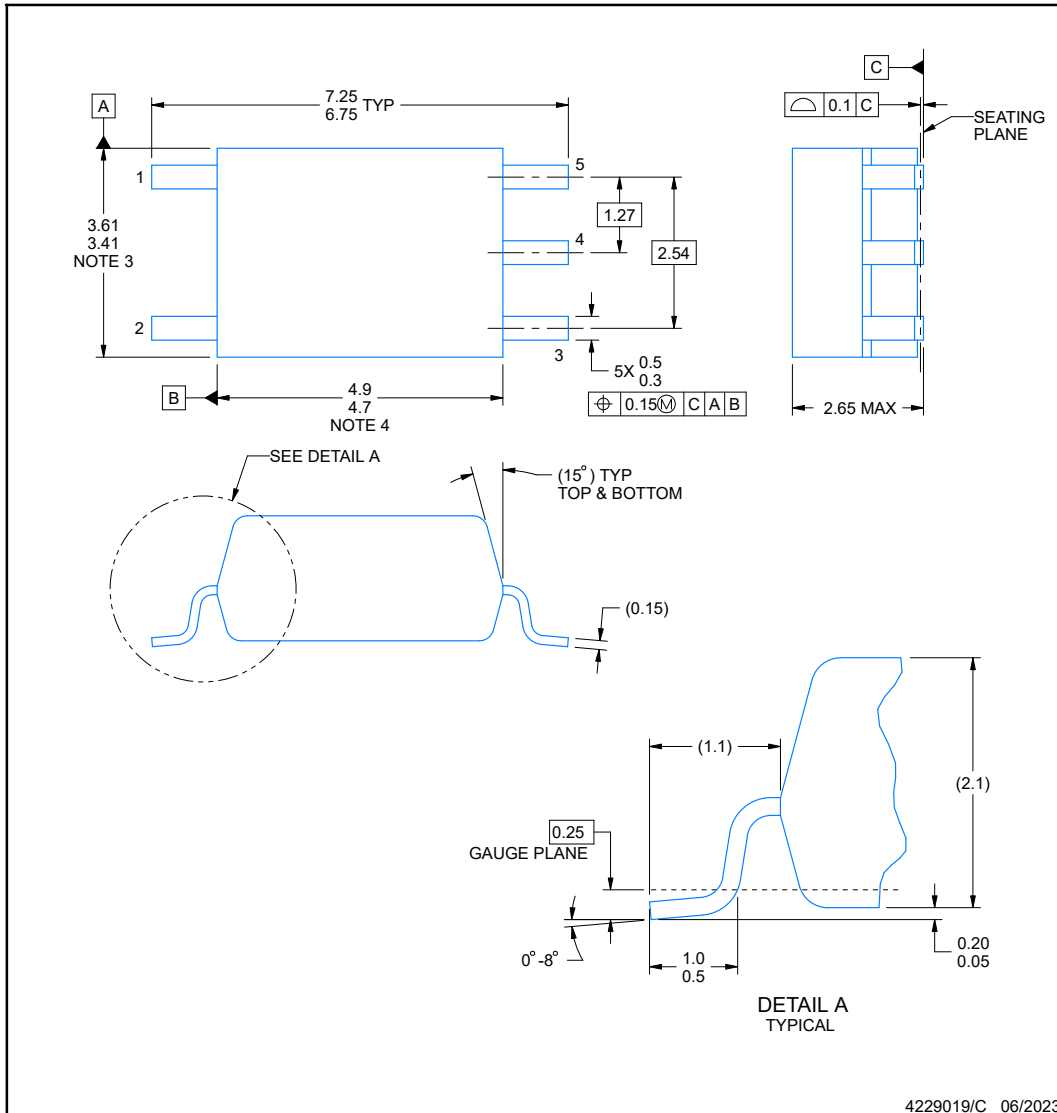

NOTES:

1. All linear dimensions are in millimeters. Any dimensions in parenthesis are for reference only. Dimensioning and tolerancing per ASME Y14.5M.
2. This drawing is subject to change without notice.
3. This dimension does not include mold flash, protrusions, or gate burrs. Mold flash, protrusions, or gate burrs shall not exceed 0.15 mm per side.
4. This dimension does not include interlead flash.

EXAMPLE BOARD LAYOUT

DFF0005A-C01

SOIC - 2.65 mm max height

SMALL OUTLINE INTEGRATED CIRCUIT

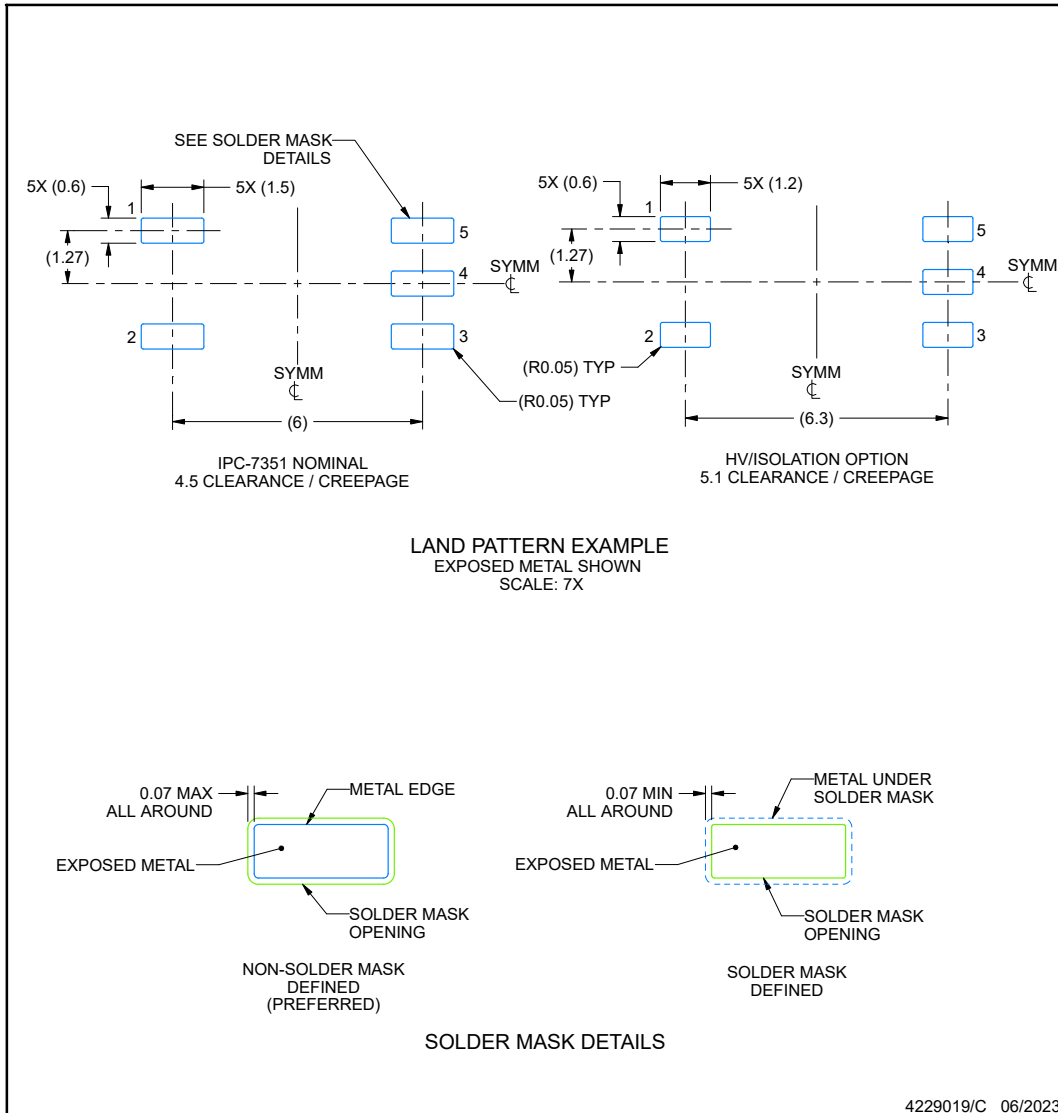

NOTES: (continued)

5. Publication IPC-7351 may have alternate designs.
6. Solder mask tolerances between and around signal pads can vary based on board fabrication site.

EXAMPLE STENCIL DESIGN

DFF0005A-C01

SOIC - 2.65 mm max height

SMALL OUTLINE INTEGRATED CIRCUIT

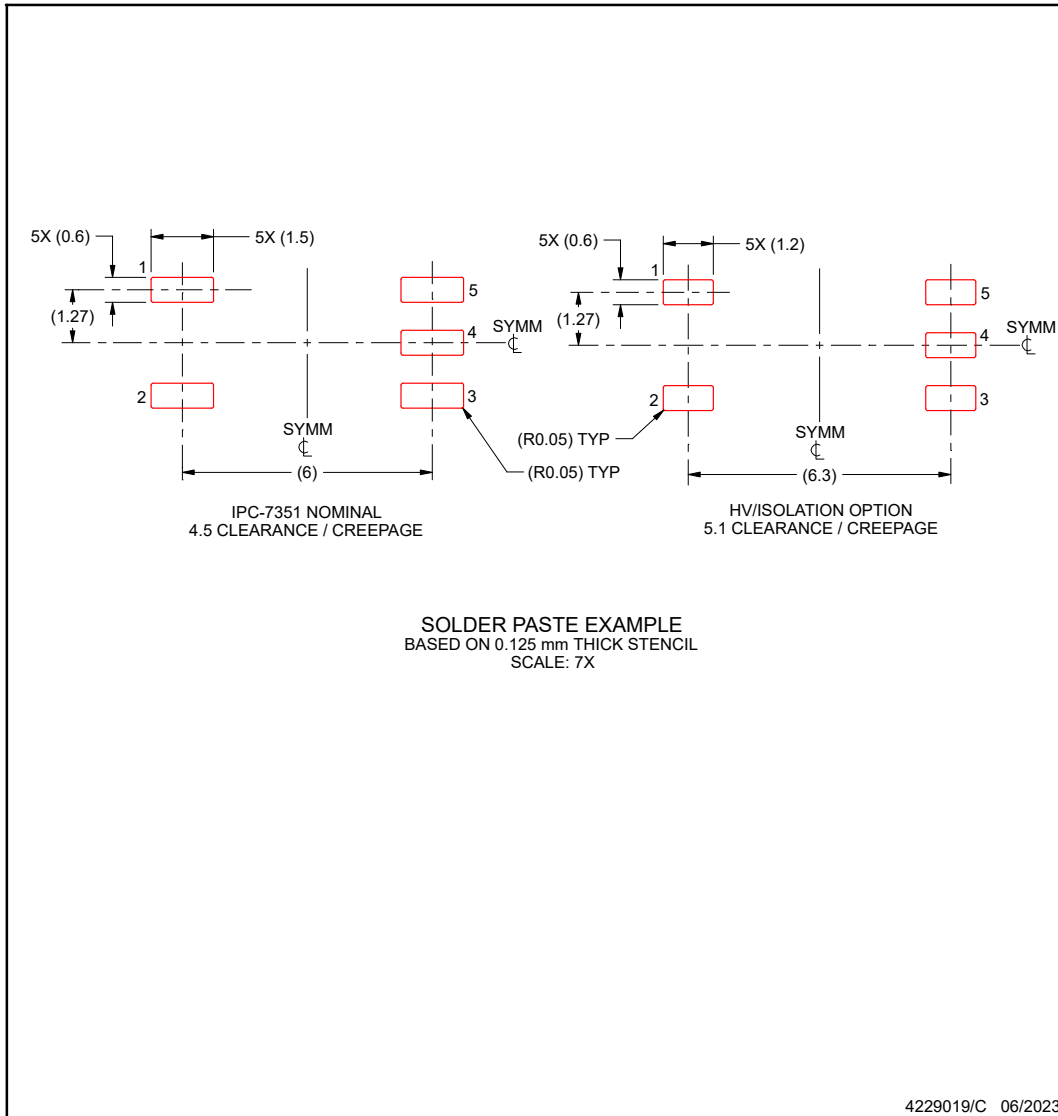

NOTES: (continued)

- 7. Laser cutting apertures with trapezoidal walls and rounded corners may offer better paste release. IPC-7525 may have alternate design recommendations.
- 8. Board assembly site may have different recommendations for stencil design.

PACKAGING INFORMATION

Orderable Device	Status (1)	Package Type	Package Drawing	Pins	Package Qty	Eco Plan (2)	Lead finish/ Ball material (6)	MSL Peak Temp (3)	Op Temp (°C)	Device Marking (4/5)	Samples
ISOM8710DFFR	ACTIVE	SOIC	DFF	5	2000	RoHS & Green	NIPDAU	Level-2-260C-1 YEAR	-40 to 125	8710	Samples
ISOM8711DFFR	ACTIVE	SOIC	DFF	5	2000	RoHS & Green	NIPDAU	Level-2-260C-1 YEAR	-40 to 125	8711	Samples
XISOM8710DFF	ACTIVE	SOIC	DFF	5	75	TBD	Call TI	Call TI	-40 to 125		Samples
XISOM8711DFFR	ACTIVE	SOIC	DFF	5	2000	TBD	Call TI	Call TI	-40 to 125		Samples

(1) The marketing status values are defined as follows:

ACTIVE: Product device recommended for new designs.

LIFEBUY: TI has announced that the device will be discontinued, and a lifetime-buy period is in effect.

NRND: Not recommended for new designs. Device is in production to support existing customers, but TI does not recommend using this part in a new design.

PREVIEW: Device has been announced but is not in production. Samples may or may not be available.

OBSELETE: TI has discontinued the production of the device.

(2) **RoHS:** TI defines "RoHS" to mean semiconductor products that are compliant with the current EU RoHS requirements for all 10 RoHS substances, including the requirement that RoHS substance do not exceed 0.1% by weight in homogeneous materials. Where designed to be soldered at high temperatures, "RoHS" products are suitable for use in specified lead-free processes. TI may reference these types of products as "Pb-Free".

RoHS Exempt: TI defines "RoHS Exempt" to mean products that contain lead but are compliant with EU RoHS pursuant to a specific EU RoHS exemption.

Green: TI defines "Green" to mean the content of Chlorine (Cl) and Bromine (Br) based flame retardants meet JS709B low halogen requirements of <=1000ppm threshold. Antimony trioxide based flame retardants must also meet the <=1000ppm threshold requirement.

(3) MSL, Peak Temp. - The Moisture Sensitivity Level rating according to the JEDEC industry standard classifications, and peak solder temperature.

(4) There may be additional marking, which relates to the logo, the lot trace code information, or the environmental category on the device.

(5) Multiple Device Markings will be inside parentheses. Only one Device Marking contained in parentheses and separated by a "-" will appear on a device. If a line is indented then it is a continuation of the previous line and the two combined represent the entire Device Marking for that device.

(6) Lead finish/Ball material - Orderable Devices may have multiple material finish options. Finish options are separated by a vertical ruled line. Lead finish/Ball material values may wrap to two lines if the finish value exceeds the maximum column width.

Important Information and Disclaimer:The information provided on this page represents TI's knowledge and belief as of the date that it is provided. TI bases its knowledge and belief on information provided by third parties, and makes no representation or warranty as to the accuracy of such information. Efforts are underway to better integrate information from third parties. TI has taken and

continues to take reasonable steps to provide representative and accurate information but may not have conducted destructive testing or chemical analysis on incoming materials and chemicals. TI and TI suppliers consider certain information to be proprietary, and thus CAS numbers and other limited information may not be available for release.

In no event shall TI's liability arising out of such information exceed the total purchase price of the TI part(s) at issue in this document sold by TI to Customer on an annual basis.

TAPE AND REEL INFORMATION

QUADRANT ASSIGNMENTS FOR PIN 1 ORIENTATION IN TAPE

*All dimensions are nominal

Device	Package Type	Package Drawing	Pins	SPQ	Reel Diameter (mm)	Reel Width W1 (mm)	A0 (mm)	B0 (mm)	K0 (mm)	P1 (mm)	W (mm)	Pin1 Quadrant
ISOM8710DFFR	SOIC	DFF	5	2000	330.0	12.4	8.0	3.8	2.7	12.0	12.0	Q1
ISOM8711DFFR	SOIC	DFF	5	2000	330.0	12.4	8.0	3.8	2.7	12.0	12.0	Q1

TAPE AND REEL BOX DIMENSIONS

*All dimensions are nominal

Device	Package Type	Package Drawing	Pins	SPQ	Length (mm)	Width (mm)	Height (mm)
ISOM8710DFFR	SOIC	DFF	5	2000	356.0	356.0	35.0
ISOM8711DFFR	SOIC	DFF	5	2000	356.0	356.0	35.0

IMPORTANT NOTICE AND DISCLAIMER

TI PROVIDES TECHNICAL AND RELIABILITY DATA (INCLUDING DATA SHEETS), DESIGN RESOURCES (INCLUDING REFERENCE DESIGNS), APPLICATION OR OTHER DESIGN ADVICE, WEB TOOLS, SAFETY INFORMATION, AND OTHER RESOURCES "AS IS" AND WITH ALL FAULTS, AND DISCLAIMS ALL WARRANTIES, EXPRESS AND IMPLIED, INCLUDING WITHOUT LIMITATION ANY IMPLIED WARRANTIES OF MERCHANTABILITY, FITNESS FOR A PARTICULAR PURPOSE OR NON-INFRINGEMENT OF THIRD PARTY INTELLECTUAL PROPERTY RIGHTS.

These resources are intended for skilled developers designing with TI products. You are solely responsible for (1) selecting the appropriate TI products for your application, (2) designing, validating and testing your application, and (3) ensuring your application meets applicable standards, and any other safety, security, regulatory or other requirements.

These resources are subject to change without notice. TI grants you permission to use these resources only for development of an application that uses the TI products described in the resource. Other reproduction and display of these resources is prohibited. No license is granted to any other TI intellectual property right or to any third party intellectual property right. TI disclaims responsibility for, and you will fully indemnify TI and its representatives against, any claims, damages, costs, losses, and liabilities arising out of your use of these resources.

TI's products are provided subject to [TI's Terms of Sale](#) or other applicable terms available either on [ti.com](https://www.ti.com) or provided in conjunction with such TI products. TI's provision of these resources does not expand or otherwise alter TI's applicable warranties or warranty disclaimers for TI products.

TI objects to and rejects any additional or different terms you may have proposed.

Mailing Address: Texas Instruments, Post Office Box 655303, Dallas, Texas 75265
Copyright © 2023, Texas Instruments Incorporated