

## 1-A, Positive Fixed-Voltage, Low-Dropout Regulator

### FEATURES

- Accuracy: 1.5% (typ)
- Low  $I_Q$ : 100  $\mu$ A (max)
  - 500x Lower Than Standard 1117 Devices
- $V_{IN}$ : 2.0 V to 5.5 V
  - Absolute Maximum  $V_{IN}$ : 6.0 V
- Stable with 0-mA Output Current
- Low Dropout: 455 mV at 1 A for  $V_{OUT} = 3.3$  V
- High PSRR: 65 dB at 1 kHz
- Minimum Ensured Current Limit: 1.1 A
- Stable with Cost-Effective Ceramic Capacitors:
  - With 0- $\Omega$  ESR
- Temperature Range:  $-40^{\circ}\text{C}$  to  $+125^{\circ}\text{C}$
- Thermal Shutdown and Overcurrent Protection
- Available Package: SOT223
  - See the *Package Option Addendum* at the end of this document for a complete list of available voltage options.

### APPLICATIONS

- Set Top Boxes
- TVs and Monitors
- PC Peripherals, Notebooks, and Motherboards
- Modems and Other Communication Products
- Switching Power-Supply Post-Regulation

### DESCRIPTION

The TLV1171 low-dropout (LDO) linear regulator is a low input voltage version of the popular 1117 voltage regulator.

The TLV1171 is an extremely low-power device that consumes 500x lower quiescent current than the traditional 1117 voltage regulator, making the TLV1171 suitable for applications that mandate very low standby current. The TLV1171 LDO is also stable with 0 mA of load current; there is no minimum load requirement, making the device an ideal choice for applications where the regulator is required to power very small loads during standby in addition to large currents on the order of 1 A during normal operation. The TLV1171 offers excellent line and load transient performance, resulting in very small magnitude output voltage undershoots and overshoots when the load current requirement changes from less than 1 mA to more than 500 mA.

A precision band gap and error amplifier provides 1.5% accuracy. A very high power-supply rejection ratio enables the device to be used for post-regulation after a switching regulator. Other valuable features include low output noise and low-dropout voltage.

The device is internally compensated to be stable with 0- $\Omega$  equivalent series resistance (ESR) capacitors. These key advantages enable the use of cost-effective, small-size ceramic capacitors. Cost-effective capacitors that have higher bias voltages and temperature derating can also be used if desired.

The TLV1171 is available in a SOT223 package. For alternate pin outs of the device, refer to the [TLV1117LV](#).

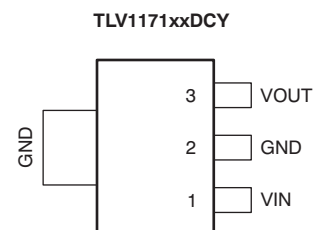

Please be aware that an important notice concerning availability, standard warranty, and use in critical applications of Texas Instruments semiconductor products and disclaimers thereto appears at the end of this data sheet.

All trademarks are the property of their respective owners.



This integrated circuit can be damaged by ESD. Texas Instruments recommends that all integrated circuits be handled with appropriate precautions. Failure to observe proper handling and installation procedures can cause damage.

ESD damage can range from subtle performance degradation to complete device failure. Precision integrated circuits may be more susceptible to damage because very small parametric changes could cause the device not to meet its published specifications.

### ORDERING INFORMATION<sup>(1)</sup>

PRODUCT	V <sub>OUT</sub>
TLV1171vvyzz	<b>VV</b> is the nominal output voltage (for example, 33 = 3.3 V). <b>YYY</b> is the package designator. <b>Z</b> is the package quantity. Use <i>R</i> for reel (2500 pieces), and <i>T</i> for tape (250 pieces).

- (1) For the most current package and ordering information see the Package Option Addendum at the end of this document, or visit the device product folder at [www.ti.com](http://www.ti.com).

### ABSOLUTE MAXIMUM RATINGS<sup>(1)</sup>

At T<sub>J</sub> = +25°C, unless otherwise noted. All voltages are with respect to GND.

		VALUE		UNIT
		MIN	MAX	
Voltage	Input voltage range, V <sub>IN</sub>	-0.3	+6.0	V
	Output voltage range, V <sub>OUT</sub>	-0.3	+6.0	V
Current	Maximum output current, I <sub>OUT</sub>	Internally limited		
Output short-circuit duration		Indefinite		
Continuous total power dissipation	P <sub>DISS</sub>	See <a href="#">Thermal Information</a> Table		
Temperature	Operating junction, T <sub>J</sub>	-55	+150	°C
	Storage, T <sub>stg</sub>	-55	+150	°C
Electrostatic discharge (ESD) ratings	Human body model (HBM) QSS 009-105 (JESD22-A114A)		2	kV
	Charged device model (CDM) QSS 009-147 (JESD22-C101B.01)		500	V

- (1) Stresses beyond those listed under *absolute maximum ratings* may cause permanent damage to the device. These are stress ratings only, and functional operation of the device at these or any other conditions beyond those indicated under *recommended operating conditions* is not implied. Exposure to absolute-maximum-rated conditions for extended periods may affect device reliability.

### THERMAL INFORMATION

THERMAL METRIC <sup>(1)</sup>	TLV1171	UNITS
	DCY (SOT223)	
	3 PINS	
θ <sub>JA</sub> Junction-to-ambient thermal resistance	62.9	°C/W
θ <sub>JCtop</sub> Junction-to-case (top) thermal resistance	47.2	
θ <sub>JB</sub> Junction-to-board thermal resistance	12.0	
ψ <sub>JT</sub> Junction-to-top characterization parameter	6.1	
ψ <sub>JB</sub> Junction-to-board characterization parameter	11.9	
θ <sub>JCbot</sub> Junction-to-case (bottom) thermal resistance	N/A	

- (1) For more information about traditional and new thermal metrics, see the [IC Package Thermal Metrics](#) application report, [SPRA953A](#).

## ELECTRICAL CHARACTERISTICS

At  $T_A = +25^\circ\text{C}$ ,  $V_{IN} = V_{OUT(TYP)} + 1.5\text{ V}$ ,  $I_{OUT} = 10\text{ mA}$ , and  $C_{OUT} = 1.0\text{ }\mu\text{F}$ , unless otherwise noted.

PARAMETER	TEST CONDITIONS	TLV1171			UNIT		
		MIN	TYP	MAX			
$V_{IN}$	Input voltage range	2.0		5.5	V		
$V_{OUT}$	DC output accuracy	$V_{OUT} > 2\text{ V}$	-1.5	+1.5	%		
		$1.5\text{ V} \leq V_{OUT} < 2\text{ V}$	-2	+2	%		
		$1.2\text{ V} \leq V_{OUT} < 1.5\text{ V}$	-40	+40	mV		
$\Delta V_O/\Delta V_{IN}$	Line regulation	$V_{OUT(NOM)} + 0.5\text{ V} \leq V_{IN} \leq 5.5\text{ V}$ , $I_{OUT} = 10\text{ mA}$			mV		
$\Delta V_O/\Delta I_{OUT}$	Load regulation	$0\text{ mA} \leq I_{OUT} \leq 1\text{ A}$			mV		
$V_{DO}$	Dropout voltage <sup>(1)</sup>	$V_{IN} = 0.98 \times V_{OUT(NOM)}$	$V_{OUT} < 3.3\text{ V}$	$I_{OUT} = 200\text{ mA}$	115	mV	
				$I_{OUT} = 500\text{ mA}$	285	mV	
			$V_{OUT} \geq 3.3\text{ V}$	$I_{OUT} = 800\text{ mA}$	455	mV	
				$I_{OUT} = 1\text{ A}$	570	800	mV
		$I_{OUT} = 200\text{ mA}$		90	mV		
		$I_{OUT} = 500\text{ mA}$		230	mV		
					$I_{OUT} = 800\text{ mA}$	365	mV
					$I_{OUT} = 1\text{ A}$	455	700
$I_{CL}$	Output current limit	$V_{OUT} = 0.9 \times V_{OUT(NOM)}$			1.1	A	
$I_Q$	Quiescent current	$I_{OUT} = 0\text{ mA}$			50	100	$\mu\text{A}$
PSRR	Power-supply rejection ratio	$V_{IN} = 3.3\text{ V}$ , $V_{OUT} = 1.8\text{ V}$ , $I_{OUT} = 500\text{ mA}$ , $f = 100\text{ Hz}$			65	dB	
$V_N$	Output noise voltage	BW = 10 Hz to 100 kHz, $V_{IN} = 2.8\text{ V}$ , $V_{OUT} = 1.8\text{ V}$ , $I_{OUT} = 500\text{ mA}$			60	$\mu\text{V}_{RMS}$	
$t_{STR}$	Startup time <sup>(2)</sup>	$C_{OUT} = 1.0\text{ }\mu\text{F}$ , $I_{OUT} = 1\text{ A}$			100	$\mu\text{s}$	
UVLO	Undervoltage lockout	$V_{IN}$ rising			1.95	V	
$T_{SD}$	Thermal shutdown temperature	Shutdown, temperature increasing			+165	$^\circ\text{C}$	
		Reset, temperature decreasing			+145	$^\circ\text{C}$	
$T_J$	Operating junction temperature				-40	+125	$^\circ\text{C}$

(1)  $V_{DO}$  is measured for devices with  $V_{OUT(NOM)} = 2.5\text{ V}$  so that  $V_{IN} = 2.45\text{ V}$ .

(2) Startup time is the time from when  $V_{IN}$  asserts to when output is sustained at a value greater than or equal to  $0.98 \times V_{OUT(NOM)}$ .

### PIN CONFIGURATION

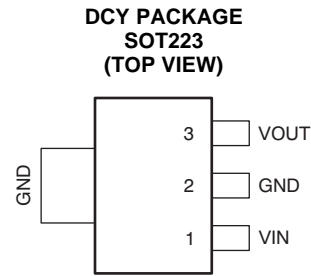

### PIN DESCRIPTIONS

NAME	PIN	DESCRIPTION
GND	2, Tab	Ground pin
IN	1	Input pin. See the <a href="#">Input and Output Capacitor Requirements</a> section for more details.
OUT	3	Regulated output voltage pin. See the <a href="#">Input and Output Capacitor Requirements</a> section for more details.

### FUNCTIONAL BLOCK DIAGRAM

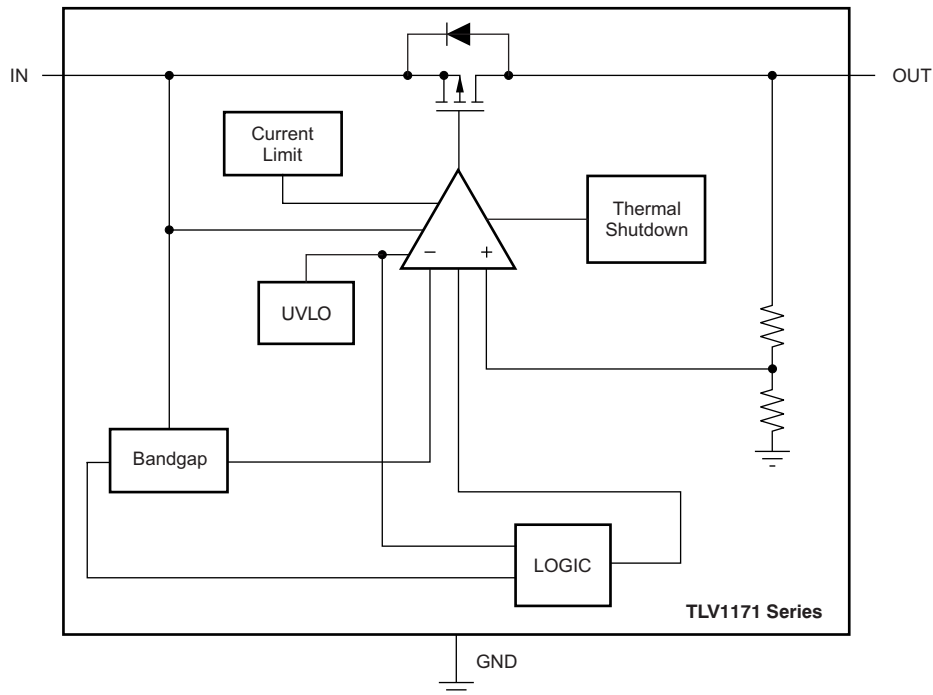

Figure 1. Block Diagram

### TYPICAL CHARACTERISTICS

At  $T_A = +25^\circ\text{C}$ ,  $V_{IN} = V_{OUT(TYP)} + 1.5\text{ V}$ ;  $I_{OUT} = 10\text{ mA}$ , and  $C_{OUT} = 1.0\ \mu\text{F}$ , unless otherwise noted.

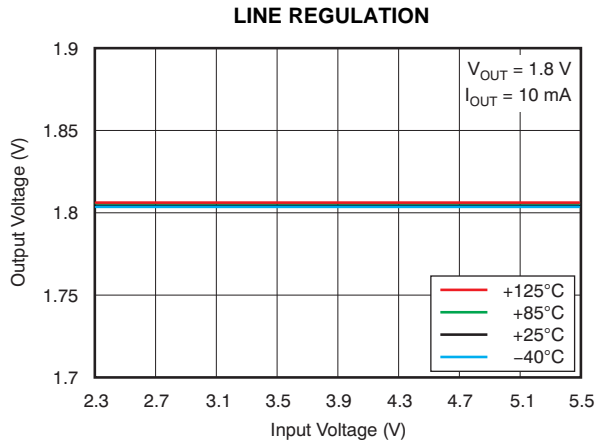

Figure 2.

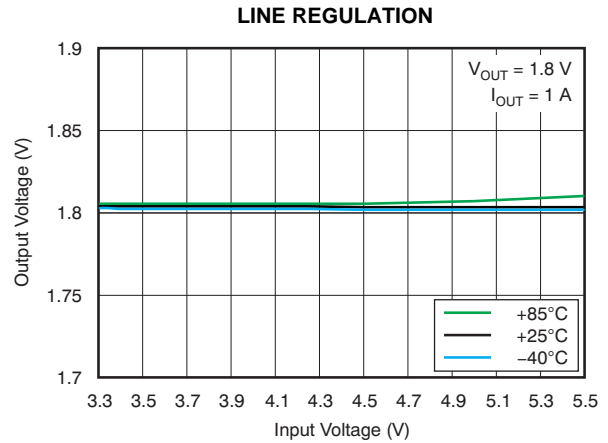

Figure 3.

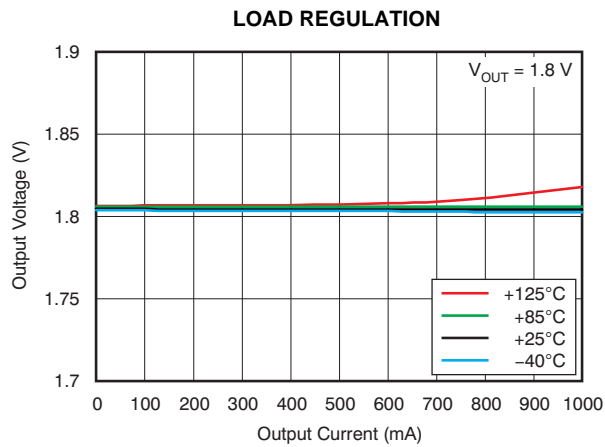

Figure 4.

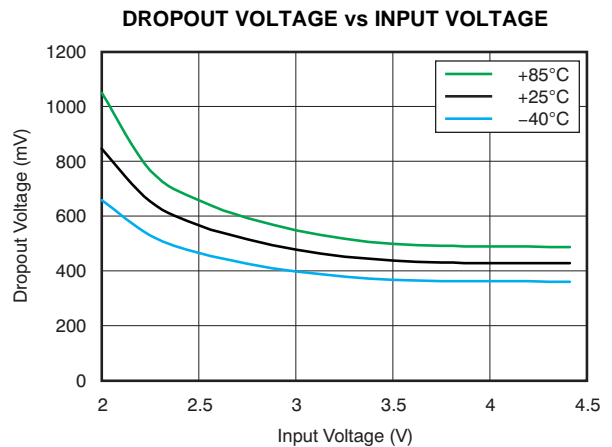

Figure 5.

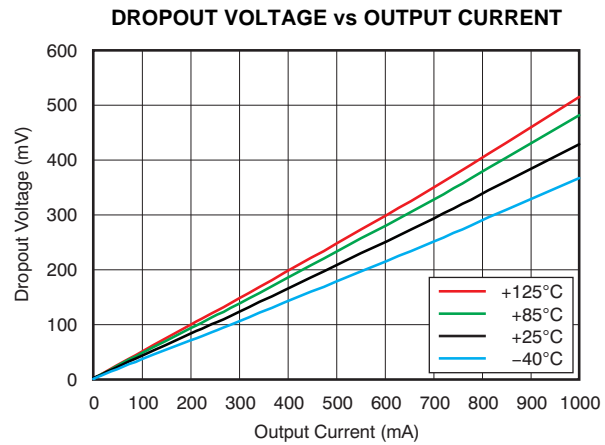

Figure 6.

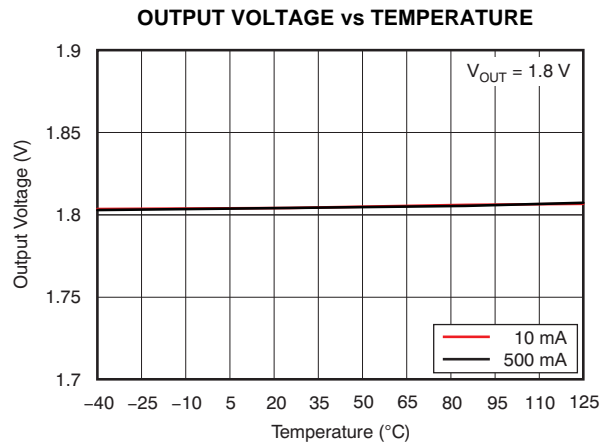

Figure 7.

### TYPICAL CHARACTERISTICS (continued)

At  $T_A = +25^\circ\text{C}$ ,  $V_{IN} = V_{OUT(TYP)} + 1.5\text{ V}$ ;  $I_{OUT} = 10\text{ mA}$ , and  $C_{OUT} = 1.0\ \mu\text{F}$ , unless otherwise noted.

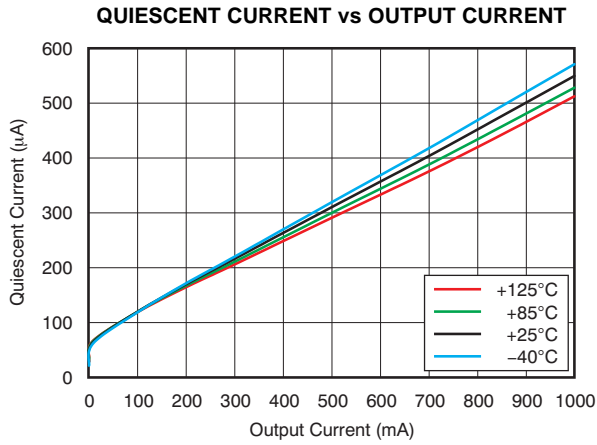

Figure 8.

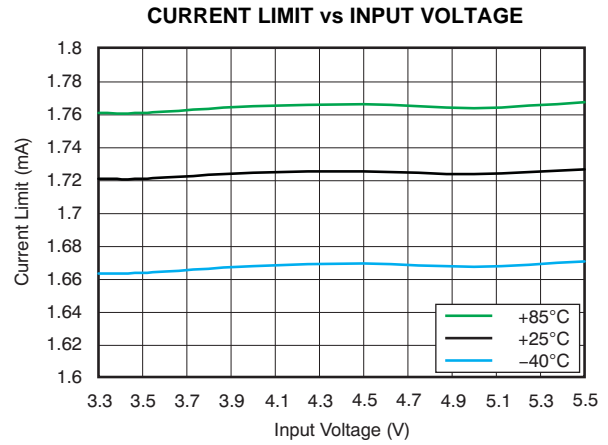

Figure 9.

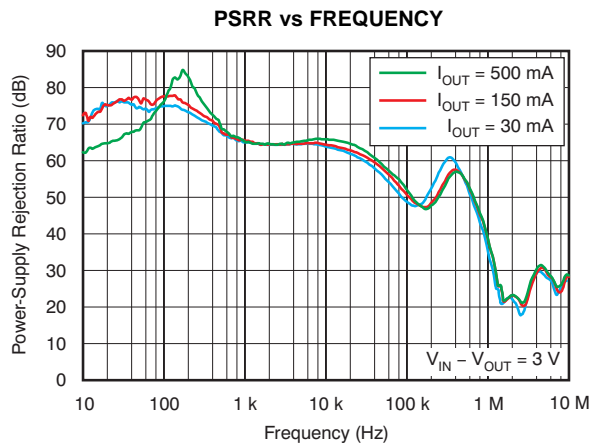

Figure 10.

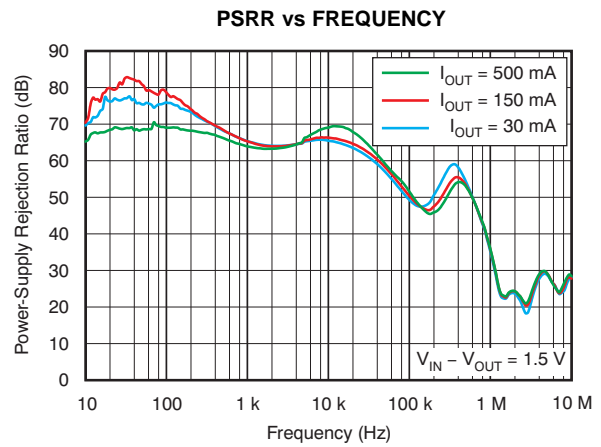

Figure 11.

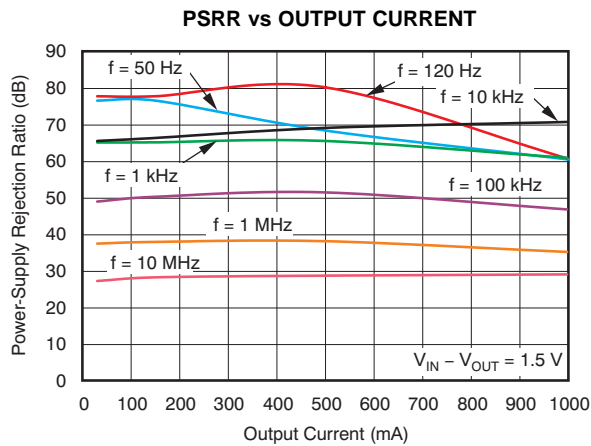

Figure 12.

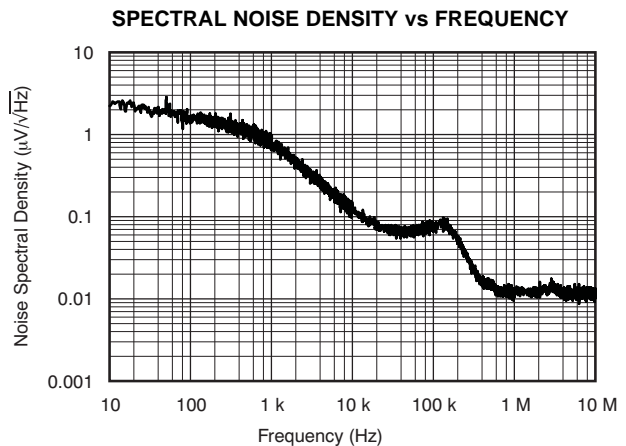
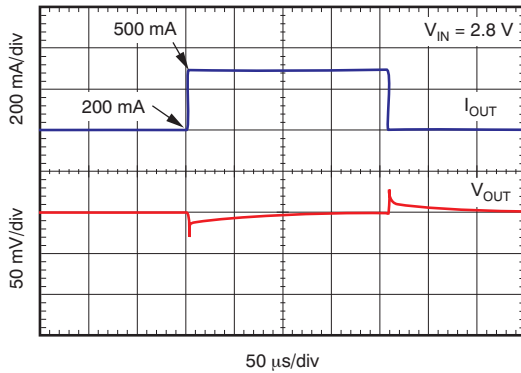

Figure 13.

**TYPICAL CHARACTERISTICS (continued)**

At  $T_A = +25^\circ\text{C}$ ,  $V_{IN} = V_{OUT(TYP)} + 1.5\text{ V}$ ;  $I_{OUT} = 10\text{ mA}$ , and  $C_{OUT} = 1.0\ \mu\text{F}$ , unless otherwise noted.

**LOAD TRANSIENT RESPONSE**  
(200 mA to 500 mA,  $C_{OUT} = 1\ \mu\text{F}$ )



**Figure 14.**

**LOAD TRANSIENT RESPONSE**  
(200 mA to 500 mA,  $C_{OUT} = 10\ \mu\text{F}$ )

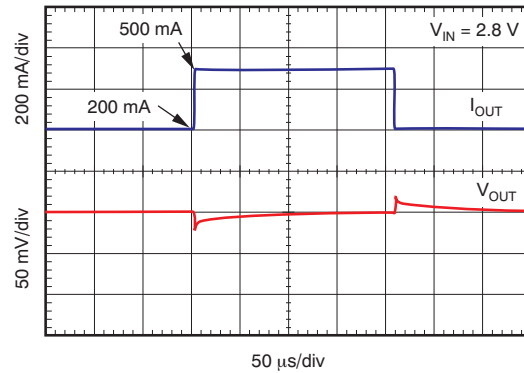

**Figure 15.**

**LOAD TRANSIENT RESPONSE**  
(1 mA to 500 mA,  $C_{OUT} = 1\ \mu\text{F}$ )

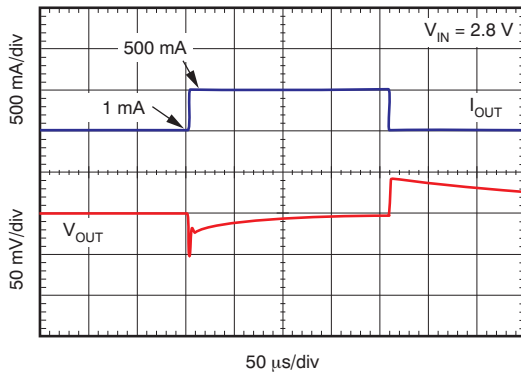

**Figure 16.**

**LOAD TRANSIENT RESPONSE**  
(1 mA to 500 mA,  $C_{OUT} = 10\ \mu\text{F}$ )

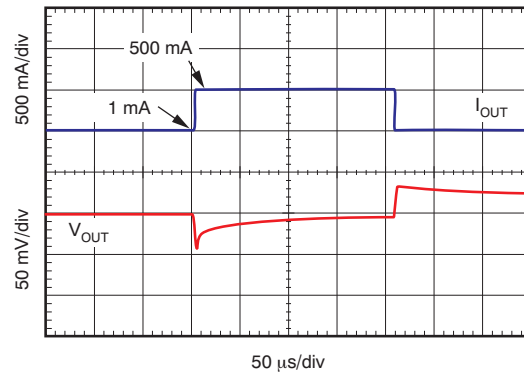

**Figure 17.**

**LOAD TRANSIENT RESPONSE**  
(200 mA to 1 A,  $C_{OUT} = 1\ \mu\text{F}$ )

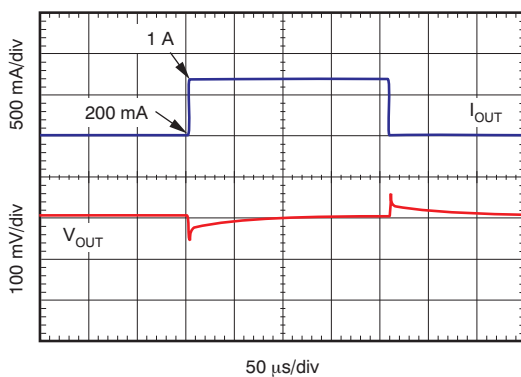

**Figure 18.**

**LOAD TRANSIENT RESPONSE**  
(200 mA to 1 A,  $C_{OUT} = 10\ \mu\text{F}$ )

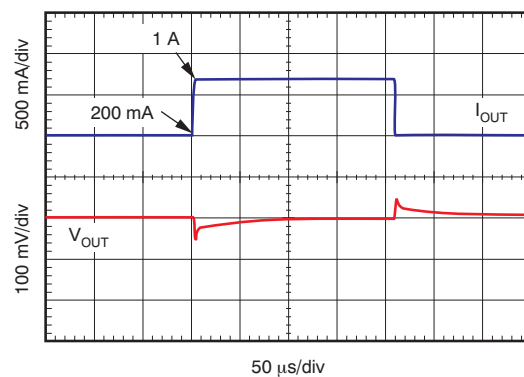

**Figure 19.**

**TYPICAL CHARACTERISTICS (continued)**

At  $T_A = +25^\circ\text{C}$ ,  $V_{IN} = V_{OUT(TYP)} + 1.5\text{ V}$ ;  $I_{OUT} = 10\text{ mA}$ , and  $C_{OUT} = 1.0\text{ }\mu\text{F}$ , unless otherwise noted.

**LOAD TRANSIENT RESPONSE**  
(1 mA to 1 A,  $C_{OUT} = 1\text{ }\mu\text{F}$ )

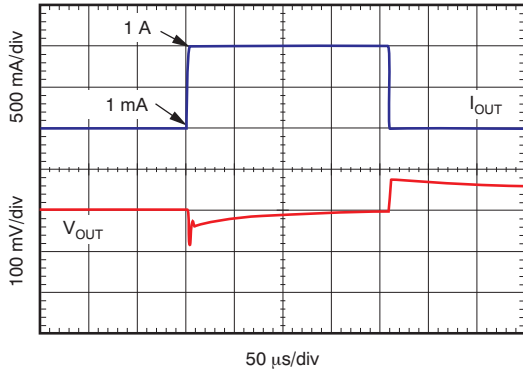

Figure 20.

**LOAD TRANSIENT RESPONSE**  
(1 mA to 1 A,  $C_{OUT} = 10\text{ }\mu\text{F}$ )

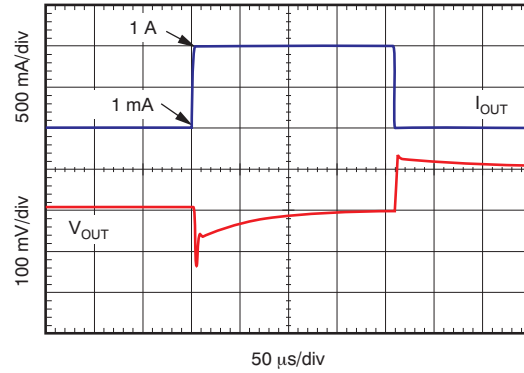

Figure 21.

**LINE TRANSIENT RESPONSE**  
( $V_{OUT} = 1.8\text{ V}$ ,  $I_{OUT} = 10\text{ mA}$ )

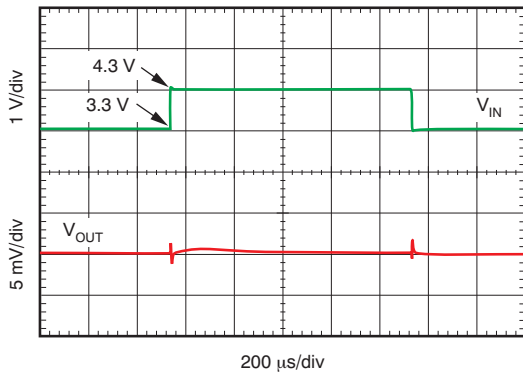

Figure 22.

**LINE TRANSIENT RESPONSE**  
( $V_{OUT} = 1.8\text{ V}$ ,  $I_{OUT} = 500\text{ mA}$ )

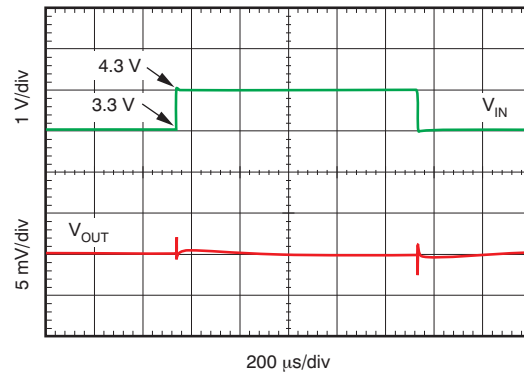

Figure 23.

**LINE TRANSIENT RESPONSE**  
( $V_{OUT} = 1.8\text{ V}$ ,  $I_{OUT} = 1\text{ A}$ )

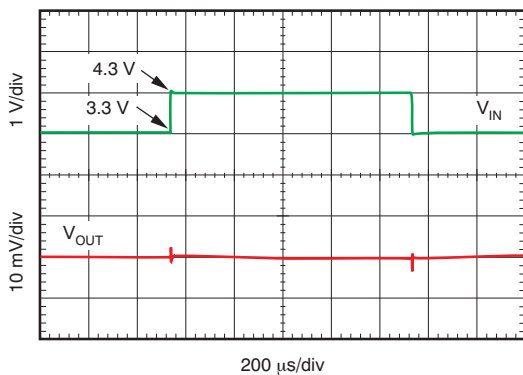

Figure 24.

**LINE TRANSIENT RESPONSE**  
( $V_{OUT} = 1.8\text{ V}$ ,  $I_{OUT} = 10\text{ mA}$ )

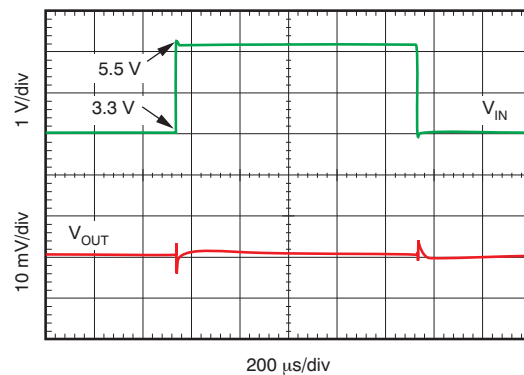

Figure 25.



**TYPICAL CHARACTERISTICS (continued)**

At  $T_A = +25^\circ\text{C}$ ,  $V_{IN} = V_{OUT(TYP)} + 1.5\text{ V}$ ;  $I_{OUT} = 10\text{ mA}$ , and  $C_{OUT} = 1.0\ \mu\text{F}$ , unless otherwise noted.

**LINE TRANSIENT RESPONSE**  
( $V_{OUT} = 1.8\text{ V}$ ,  $I_{OUT} = 500\text{ mA}$ )

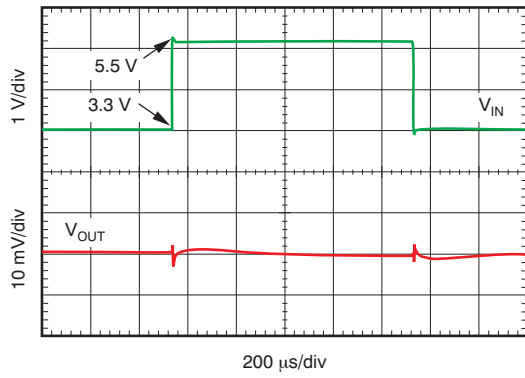

**Figure 26.**

**LINE TRANSIENT RESPONSE**  
( $V_{OUT} = 1.8\text{ V}$ ,  $I_{OUT} = 1\text{ A}$ )

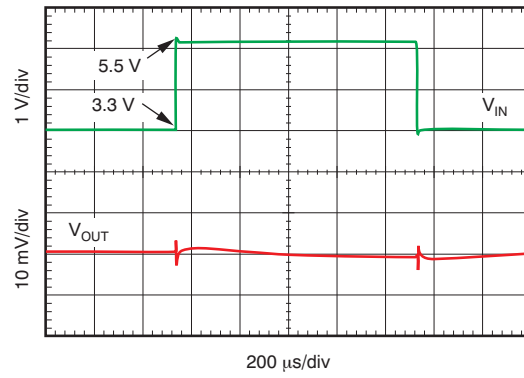

**Figure 27.**

## APPLICATION INFORMATION

The TLV1171 is a low quiescent current linear regulator designed for high-current applications. Unlike typical high-current linear regulators, the TLV1171 consumes significantly less quiescent current. The device delivers excellent line and load transient performance. The TLV1171 is low noise, and exhibits a very good power-supply rejection ratio (PSRR). As a result, the device is ideal for high-current applications that require very sensitive power-supply rails.

The TLV1171 regulator offers both current limit and thermal protection. The device operating junction temperature range is  $-40^{\circ}\text{C}$  to  $+125^{\circ}\text{C}$ .

### INPUT AND OUTPUT CAPACITOR REQUIREMENTS

For stability, 1.0- $\mu\text{F}$  ceramic capacitors are required at the output. Higher-valued capacitors improve transient performance. X5R- and X7R-type ceramic capacitors are recommended because these capacitors have minimal variation in value and equivalent series resistance (ESR) over temperature. Unlike traditional linear regulators that need a minimum ESR for stability, the TLV1171 is ensured to be stable with no ESR. Therefore, cost-effective ceramic capacitors can be used with this device. Effective output capacitance that takes bias, temperature, and aging effects into consideration must be greater than 0.5  $\mu\text{F}$  to ensure device stability.

Although an input capacitor is not required for stability, it is good analog design practice to connect a 0.1- $\mu\text{F}$  to 1.0- $\mu\text{F}$ , low-ESR capacitor across the IN and GND pins of the regulator. This capacitor counteracts reactive input sources and improves transient response, noise rejection, and ripple rejection. A higher-value capacitor may be necessary if large, fast, rise-time load transients are anticipated, or if the device is not located physically close to the power source. If source impedance is greater than 2  $\Omega$ , a 0.1- $\mu\text{F}$  input capacitor may also be necessary to ensure stability.

### BOARD LAYOUT RECOMMENDATIONS TO IMPROVE PSRR AND NOISE PERFORMANCE

Input and output capacitors should be placed as close to the device pins as possible. To improve characteristic ac performance such as PSRR, output noise, and transient response, it is recommended that the board be designed with separate ground planes for  $V_{\text{IN}}$  and  $V_{\text{OUT}}$ , with the ground plane connected only at the GND pin of the device. In addition, the output capacitor ground connection should be connected directly to the device GND pin. Higher-value ESR capacitors may degrade PSRR performance.

### INTERNAL CURRENT LIMIT

The TLV1171 internal current limit helps to protect the regulator during fault conditions. During current limit, the output sources a fixed amount of current that is largely independent of the output voltage. In such a case, the output voltage is not regulated and can be calculated by [Equation 1](#):

$$V_{\text{OUT}} = I_{\text{LIMIT}} \times R_{\text{LOAD}} \quad (1)$$

The PMOS pass transistor dissipates  $[(V_{\text{IN}} - V_{\text{OUT}}) \times I_{\text{LIMIT}}]$  until thermal shutdown is triggered and the device turns off. As the device cools down, it is turned on by the internal thermal shutdown circuit. If the fault condition continues, the device cycles between current limit and thermal shutdown. See the [Thermal Information](#) section for more details.

The PMOS pass element in the TLV1171 has a built-in body diode that conducts current when the voltage at OUT exceeds the voltage at IN. This current is not limited; if extended reverse voltage operation is anticipated, external limiting to 5% of the rated output current is recommended.

## DROPOUT VOLTAGE

The TLV1171 uses a PMOS pass transistor to achieve low dropout. When  $(V_{IN} - V_{OUT})$  is less than the dropout voltage ( $V_{DO}$ ), the PMOS pass device is in the linear region of operation and the input-to-output resistance is the  $R_{DS(ON)}$  of the PMOS pass element.  $V_{DO}$  scales approximately with output current because the PMOS device behaves like a resistor in dropout.

As with any linear regulator, PSRR and transient response are degraded as  $(V_{IN} - V_{OUT})$  approaches dropout.

## TRANSIENT RESPONSE

As with any regulator, increasing the size of the output capacitor reduces over- and undershoot magnitude.

## UNDERVOLTAGE LOCKOUT (UVLO)

The TLV1171 uses an undervoltage lockout circuit to keep the output shut off until the internal circuitry operates properly.

## THERMAL INFORMATION

Thermal protection disables the output when the junction temperature rises to approximately +165°C, thus allowing the device to cool. When the junction temperature cools to approximately +145°C, the output circuitry is again enabled. Depending on power dissipation, thermal resistance, and ambient temperature, the thermal protection circuit may cycle on and off. This cycling limits dissipation of the regulator, protecting it from damage as a result of overheating.

Any tendency to activate the thermal protection circuit indicates excessive power dissipation or an inadequate heatsink. For reliable operation, junction temperature should be limited to +125°C (max). To estimate the margin of safety in a complete design (including heatsink), increase the ambient temperature until the thermal protection is triggered; use worst-case loads and signal conditions.

The TLV1171 internal protection circuitry has been designed to protect against overload conditions. It is not intended to replace proper heatsinking. Continuously running the TLV1171 into thermal shutdown degrades device reliability.

## POWER DISSIPATION

The ability to remove heat from the die is different for each package type and presents different considerations in the printed circuit board (PCB) layout. The PCB area around the device that is free of other components moves heat from the device to ambient air. Performance data for JEDEC low and high-K boards are given in the [Thermal Information](#) table. Using heavier copper increases the effectiveness in removing heat from the device. The addition of plated through-holes to heat-dissipating layers also improves heatsink effectiveness.

Power dissipation depends on input voltage and load conditions. Power dissipation ( $P_D$ ) is equal to the product of the output current and voltage drop across the output pass element, as shown in [Equation 2](#):

$$P_D = (V_{IN} - V_{OUT}) I_{OUT} \quad (2)$$

**PACKAGING INFORMATION**

Orderable Device	Status (1)	Package Type	Package Drawing	Pins	Package Qty	Eco Plan (2)	Lead finish/ Ball material (6)	MSL Peak Temp (3)	Op Temp (°C)	Device Marking (4/5)	Samples
TLV117112DCYR	LIFEBUY	SOT-223	DCY	4	2500	RoHS & Green	SN	Level-1-260C-UNLIM	-40 to 125	YX	
TLV117112DCYT	LIFEBUY	SOT-223	DCY	4	250	RoHS & Green	SN	Level-1-260C-UNLIM	-40 to 125	YX	
TLV117115DCYR	LIFEBUY	SOT-223	DCY	4	2500	RoHS & Green	SN	Level-1-260C-UNLIM	-40 to 125	C9	
TLV117115DCYT	LIFEBUY	SOT-223	DCY	4	250	RoHS & Green	SN	Level-1-260C-UNLIM	-40 to 125	C9	
TLV117118DCYR	ACTIVE	SOT-223	DCY	4	2500	RoHS & Green	SN	Level-1-260C-UNLIM	-40 to 125	WF	Samples
TLV117118DCYT	ACTIVE	SOT-223	DCY	4	250	RoHS & Green	SN	Level-1-260C-UNLIM	-40 to 125	WF	Samples
TLV117125DCYR	ACTIVE	SOT-223	DCY	4	2500	RoHS & Green	SN	Level-1-260C-UNLIM	-40 to 125	WE	Samples
TLV117125DCYT	ACTIVE	SOT-223	DCY	4	250	RoHS & Green	SN	Level-1-260C-UNLIM	-40 to 125	WE	Samples

(1) The marketing status values are defined as follows:

**ACTIVE:** Product device recommended for new designs.

**LIFEBUY:** TI has announced that the device will be discontinued, and a lifetime-buy period is in effect.

**NRND:** Not recommended for new designs. Device is in production to support existing customers, but TI does not recommend using this part in a new design.

**PREVIEW:** Device has been announced but is not in production. Samples may or may not be available.

**OBSELETE:** TI has discontinued the production of the device.

(2) **RoHS:** TI defines "RoHS" to mean semiconductor products that are compliant with the current EU RoHS requirements for all 10 RoHS substances, including the requirement that RoHS substance do not exceed 0.1% by weight in homogeneous materials. Where designed to be soldered at high temperatures, "RoHS" products are suitable for use in specified lead-free processes. TI may reference these types of products as "Pb-Free".

**RoHS Exempt:** TI defines "RoHS Exempt" to mean products that contain lead but are compliant with EU RoHS pursuant to a specific EU RoHS exemption.

**Green:** TI defines "Green" to mean the content of Chlorine (Cl) and Bromine (Br) based flame retardants meet JS709B low halogen requirements of <=1000ppm threshold. Antimony trioxide based flame retardants must also meet the <=1000ppm threshold requirement.

(3) MSL, Peak Temp. - The Moisture Sensitivity Level rating according to the JEDEC industry standard classifications, and peak solder temperature.

(4) There may be additional marking, which relates to the logo, the lot trace code information, or the environmental category on the device.

(5) Multiple Device Markings will be inside parentheses. Only one Device Marking contained in parentheses and separated by a "-" will appear on a device. If a line is indented then it is a continuation of the previous line and the two combined represent the entire Device Marking for that device.

<sup>(6)</sup> Lead finish/Ball material - Orderable Devices may have multiple material finish options. Finish options are separated by a vertical ruled line. Lead finish/Ball material values may wrap to two lines if the finish value exceeds the maximum column width.

**Important Information and Disclaimer:**The information provided on this page represents TI's knowledge and belief as of the date that it is provided. TI bases its knowledge and belief on information provided by third parties, and makes no representation or warranty as to the accuracy of such information. Efforts are underway to better integrate information from third parties. TI has taken and continues to take reasonable steps to provide representative and accurate information but may not have conducted destructive testing or chemical analysis on incoming materials and chemicals. TI and TI suppliers consider certain information to be proprietary, and thus CAS numbers and other limited information may not be available for release.

In no event shall TI's liability arising out of such information exceed the total purchase price of the TI part(s) at issue in this document sold by TI to Customer on an annual basis.

**TAPE AND REEL INFORMATION**

**QUADRANT ASSIGNMENTS FOR PIN 1 ORIENTATION IN TAPE**

\*All dimensions are nominal

Device	Package Type	Package Drawing	Pins	SPQ	Reel Diameter (mm)	Reel Width W1 (mm)	A0 (mm)	B0 (mm)	K0 (mm)	P1 (mm)	W (mm)	Pin1 Quadrant
TLV117112DCYR	SOT-223	DCY	4	2500	330.0	12.4	7.05	7.4	1.9	8.0	12.0	Q3
TLV117112DCYT	SOT-223	DCY	4	250	180.0	12.4	7.05	7.4	1.9	8.0	12.0	Q3
TLV117118DCYR	SOT-223	DCY	4	2500	330.0	12.4	7.05	7.4	1.9	8.0	12.0	Q3
TLV117118DCYT	SOT-223	DCY	4	250	180.0	12.4	7.05	7.4	1.9	8.0	12.0	Q3
TLV117125DCYR	SOT-223	DCY	4	2500	330.0	12.4	7.05	7.4	1.9	8.0	12.0	Q3
TLV117125DCYT	SOT-223	DCY	4	250	180.0	12.4	7.05	7.4	1.9	8.0	12.0	Q3

## TAPE AND REEL BOX DIMENSIONS



\*All dimensions are nominal

Device	Package Type	Package Drawing	Pins	SPQ	Length (mm)	Width (mm)	Height (mm)
TLV117112DCYR	SOT-223	DCY	4	2500	340.0	340.0	38.0
TLV117112DCYT	SOT-223	DCY	4	250	340.0	340.0	38.0
TLV117118DCYR	SOT-223	DCY	4	2500	340.0	340.0	38.0
TLV117118DCYT	SOT-223	DCY	4	250	340.0	340.0	38.0
TLV117125DCYR	SOT-223	DCY	4	2500	340.0	340.0	38.0
TLV117125DCYT	SOT-223	DCY	4	250	340.0	340.0	38.0

DCY (R-PDSO-G4)

PLASTIC SMALL-OUTLINE



- NOTES: A. All linear dimensions are in millimeters (inches).  
 B. This drawing is subject to change without notice.  
 C. Body dimensions do not include mold flash or protrusion.  
 D. Falls within JEDEC TO-261 Variation AA.



DCY (R-PDSO-G4)

PLASTIC SMALL OUTLINE

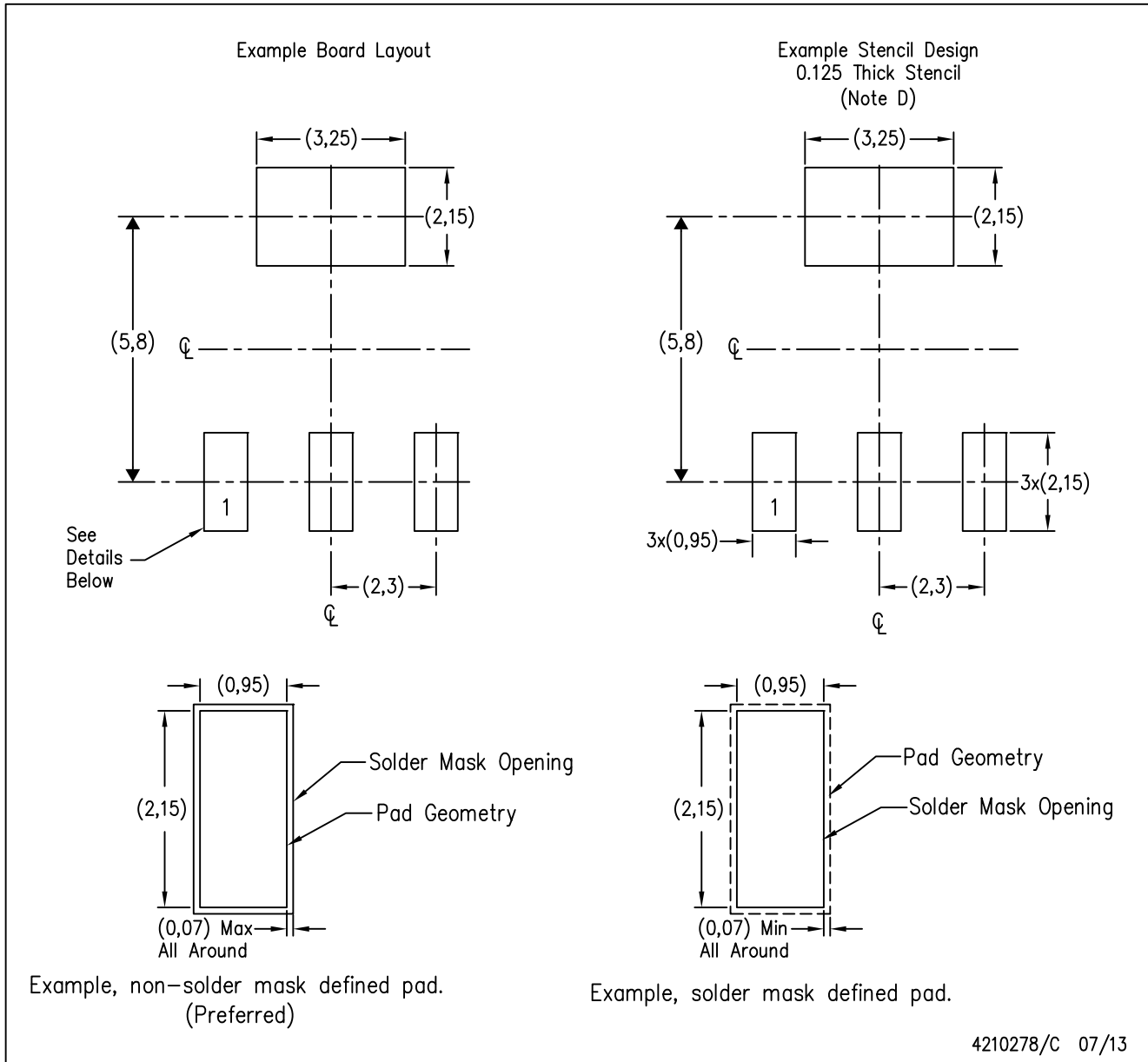

- NOTES:
- A. All linear dimensions are in millimeters.
  - B. This drawing is subject to change without notice.
  - C. Publication IPC-7351 is recommended for alternate designs.
  - D. Laser cutting apertures with trapezoidal walls and also rounding corners will offer better paste release. Customers should contact their board assembly site for stencil recommendations. Refer to IPC 7525 for stencil design considerations.

## IMPORTANT NOTICE AND DISCLAIMER

TI PROVIDES TECHNICAL AND RELIABILITY DATA (INCLUDING DATA SHEETS), DESIGN RESOURCES (INCLUDING REFERENCE DESIGNS), APPLICATION OR OTHER DESIGN ADVICE, WEB TOOLS, SAFETY INFORMATION, AND OTHER RESOURCES "AS IS" AND WITH ALL FAULTS, AND DISCLAIMS ALL WARRANTIES, EXPRESS AND IMPLIED, INCLUDING WITHOUT LIMITATION ANY IMPLIED WARRANTIES OF MERCHANTABILITY, FITNESS FOR A PARTICULAR PURPOSE OR NON-INFRINGEMENT OF THIRD PARTY INTELLECTUAL PROPERTY RIGHTS.

These resources are intended for skilled developers designing with TI products. You are solely responsible for (1) selecting the appropriate TI products for your application, (2) designing, validating and testing your application, and (3) ensuring your application meets applicable standards, and any other safety, security, regulatory or other requirements.

These resources are subject to change without notice. TI grants you permission to use these resources only for development of an application that uses the TI products described in the resource. Other reproduction and display of these resources is prohibited. No license is granted to any other TI intellectual property right or to any third party intellectual property right. TI disclaims responsibility for, and you will fully indemnify TI and its representatives against, any claims, damages, costs, losses, and liabilities arising out of your use of these resources.

TI's products are provided subject to [TI's Terms of Sale](#) or other applicable terms available either on [ti.com](https://www.ti.com) or provided in conjunction with such TI products. TI's provision of these resources does not expand or otherwise alter TI's applicable warranties or warranty disclaimers for TI products.

TI objects to and rejects any additional or different terms you may have proposed.

Mailing Address: Texas Instruments, Post Office Box 655303, Dallas, Texas 75265  
Copyright © 2023, Texas Instruments Incorporated